

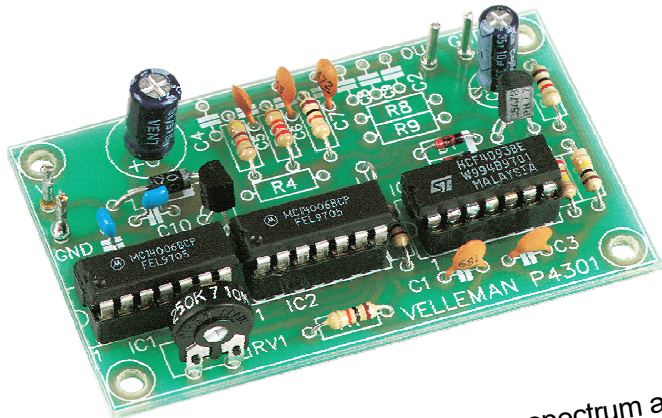

PINK NOISE GENERATOR



K4301

Add a spectrum analyser with a microphone
and check your audio system performance.



VELLEMAN NV

Legen Heirweg 33

9890 Gavere

Belgium Europe

www.velleman.be

www.velleman-kit.com

To analyse the acoustic properties of a room (usually a living- room), a good pink noise generator together with a spectrum analyser is indispensable. Moreover you need a microphone with as linear a frequency characteristic as possible (from 20 to 20000Hz.). If, in addition, you dispose of an equaliser, then you can not only check but also correct reproduction.

Features:

- Random digital noise.
- 33 bit shift register.
- Clock frequency adjustable between 30KHz and 100KHz.
- Pink noise filter: -3 dB per octave (20 .. 20000Hz.).
- Easily adaptable to produce "white noise".



Specifications:

- Output voltage: 150mV RMS./ clock frequency 40KHz.
- Output impedance: 1K ohm.
- Power supply: 9 to 12VAC, or 12 to 15VDC / 5mA.

1. Assembly (Skipping this can lead to troubles !)

Ok, so we have your attention. These hints will help you to make this project successful. Read them carefully.

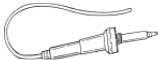
1.1 Make sure you have the right tools:

- A good quality soldering iron (25-40W) with a small tip. 
- Wipe it often on a wet sponge or cloth, to keep it clean; then apply solder to the tip, to give it a wet look. This is called 'thinning' and will protect the tip, and enables you to make good connections. When solder rolls off the tip, it needs cleaning. 
- Thin raisin-core solder. Do not use any flux or grease.
- A diagonal cutter to trim excess wires. To avoid injury when cutting excess leads, hold the lead so they cannot fly towards the eyes.
- Needle nose pliers, for bending leads, or to hold components in place.
- Small blade and Phillips screwdrivers. A basic range is fine.



For some projects, a basic multi-meter is required, or might be handy

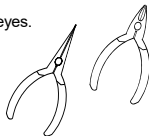

1.2 Assembly Hints :

- ⇒ Make sure the skill level matches your experience, to avoid disappointments.
- ⇒ Follow the instructions carefully. Read and understand the entire step before you perform each operation.
- ⇒ Perform the assembly in the correct order as stated in this manual
- ⇒ Position all parts on the PCB (Printed Circuit Board) as shown on the drawings.
- ⇒ Values on the circuit diagram are subject to changes, the values in this assembly guide are correct*
- ⇒ Use the check-boxes to mark your progress.
- ⇒ Please read the included information on safety and customer service

* Typographical inaccuracies excluded. Always look for possible last minute manual updates, indicated as 'NOTE' on a separate leaflet.

1.3 Soldering Hints :

1- Mount the component against the PCB surface and carefully solder the leads 

2- Make sure the solder joints are cone-shaped and shiny 

3- Trim excess leads as close as possible to the solder joint 

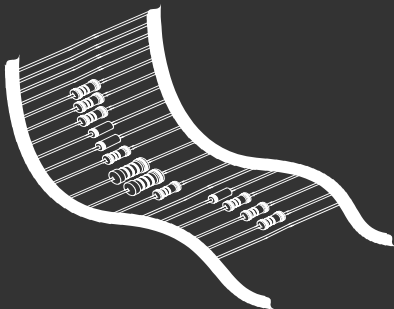

REMOVE THEM FROM THE TAPE ONE AT A TIME !

Included in
this kit

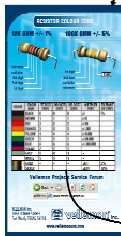

2. RESISTOR

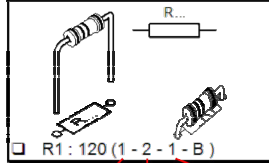

COLOUR:	COLOUR NAME	1ST DIGIT/ STRIPE	2ND DIGIT/ STRIPE	3RD DIGIT/ STRIPE	MULTIPLIER STRIPE	TOL- 4TH:
	BLACK	0	0	0	x1	1%
	BROWN	1	1	1	x10	
	RED	2	2	2	x100	
	ORANGE	3	3	3	x1,000	
	YELLOW	4	4	4	x10,000	
	GREEN	5	5	5	x100,000	
	BLUE	6	6	6	x1,000,000	

**DO NOT BLINDLY FOLLOW THE ORDER OF THE COMPONENTS ONTO THE TAPE.
ALWAYS CHECK THEIR VALUE ON THE PARTS LIST!**

1. Jumper wire

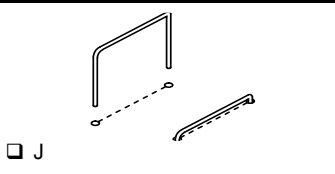

2. Diodes.

Watch the polarity !

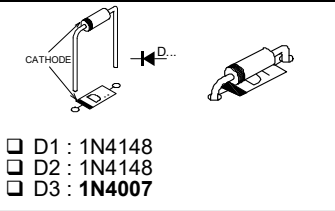

3. Resistors

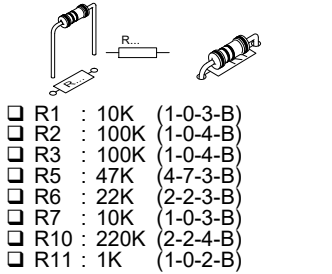

4. IC sockets. (check the position of

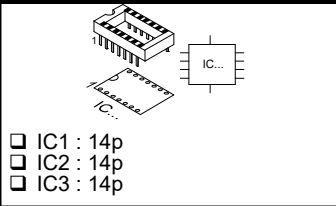

5. PCB tabs

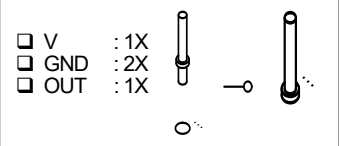

6. Capacitors

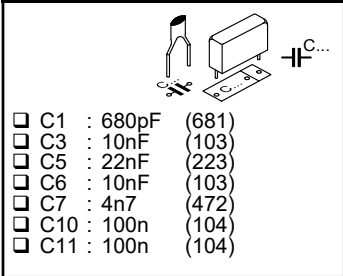

7. Transistor

- T1 : BC547B

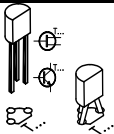

8. Voltage regulator

Mind the orientation !

- VR1 : UA78L08

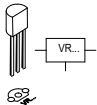

9. Trimmer

- RV1 : 220K

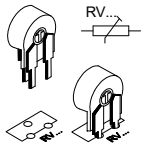

10. Capacitors. Watch the polarity !

- C12 : 10 μ F
- C13 : 100 μ F

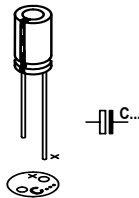

11. ICs. (check the position of the notch)

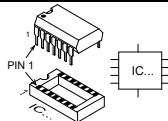

- IC1 : CD4006
- IC2 : CD4006
- IC3 : CD4093

12. TEST & ADJUSTMENT

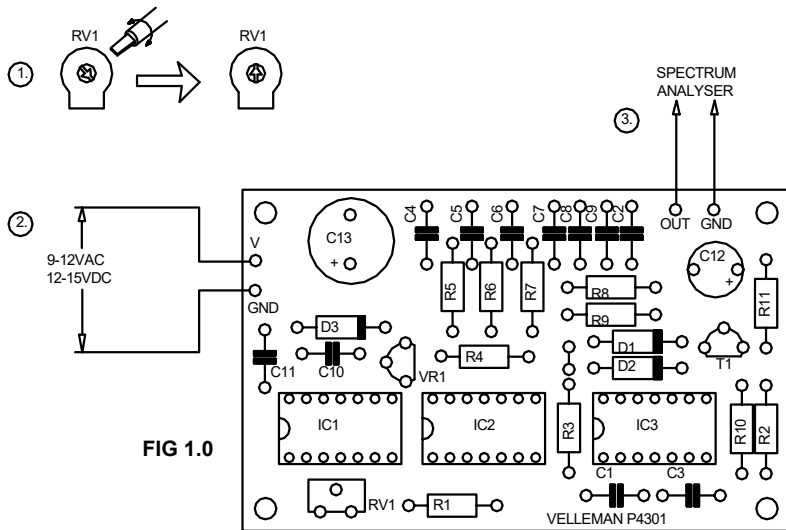

1. Turn trimmer RV1 to its centre position.
 2. Connect a power supply :
 - AC, 9 to 12 V then between points GND and V.
 - DC, 12 to 15 V (battery or power supply) then - to GND and + to V.
 3. Connect the output (OUT, GND) to the input of a spectrum analyser, using a screened flex (screen to GND).
- Now adjust the noise signal using trimmer RV1 so as to obtain as flat a reproduction characteristic as possible. Especially pay attention to the higher frequencies (adjust spectrum analyser sensitivity if necessary).

👉 **Remark:** *the nature of the lower frequencies (32 and 64Hz) makes their read-out unstable.*

FOR THOSE WHO LIKE TO EXPERIMENT : By adapting C1 you can also modify the clock frequency (pin 3 of IC2) of the shift register (e.g. C1=18pF for a clock frequency up to and beyond 500KHz), so as to obtain a "white noise" at 500KHz and to adapt the filter (C2=100pF, do not fit C4 through C9). Output voltage will drop down to +/- 100mV RMS.

13. Schematic diagram.

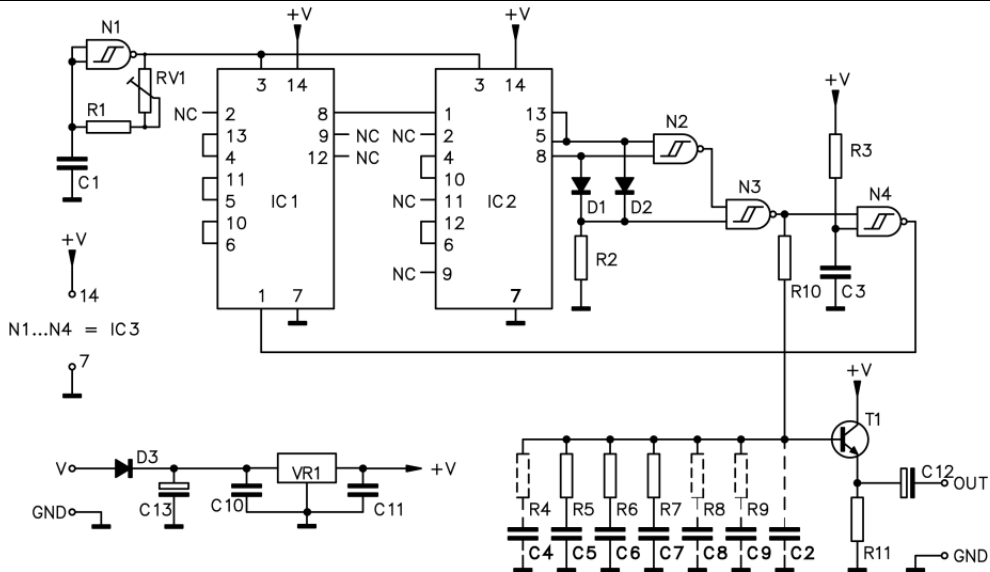

14. PCB

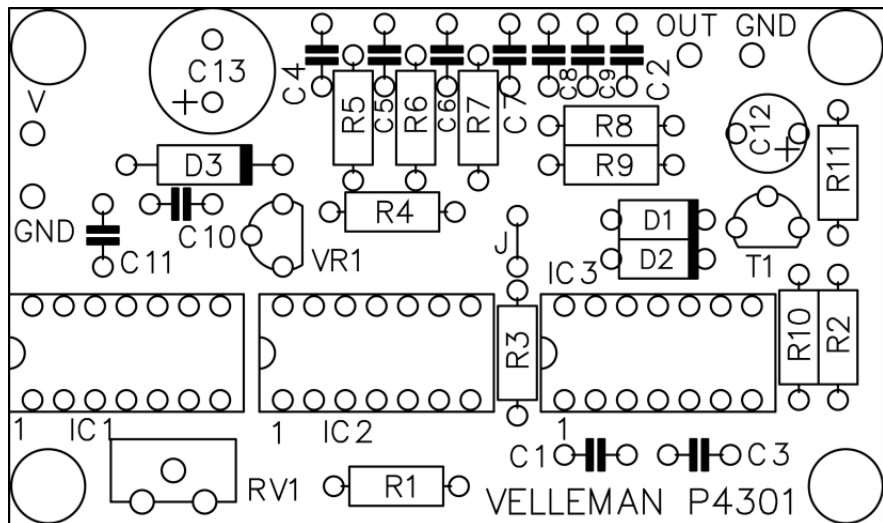

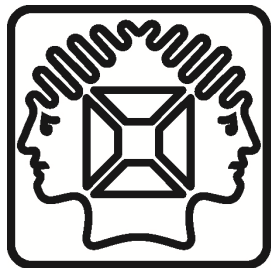

VELLEMAN NV
Legen Heirweg 33, B-9890 GAVERE
Belgium (Europe)

 @velleman_RnD

