

VOLUME AND TONE CONTROL - PREAMPLIFIER

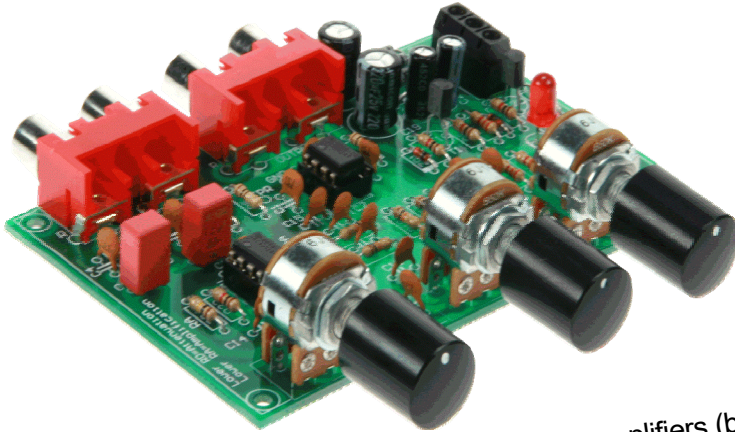

K8084

When using one of our amplifiers (big or small), you always need a volume control and preferably also a tone control

When using one of our amplifiers (big or small), you always need a volume control and preferably also a tone control. This kit comes complete with all input / output connections and potentiometers. Furthermore it is possible to amplify or attenuate the input signal.

FEATURES:

- stereo volume control
- stereo Baxandall bass and treble control
- bass and treble potentiometers with centre click
- customizable attenuation or amplification
- complete with knobs

SPECIFICATIONS:

- supply voltage: 2 x 12VAC / 100mA
- frequency response: 3Hz - 500kHz (-3dB)
- standard amplification: x1
- signal to noise ratio: 98dB
- harmonic distortion: < 0.005% (@1KHz)
- maximum output: 5V RMS
- tone control:
 - + and -15dB @ 20Hz
 - + and -15dB @ 15kHz
- Input impedance: 50k ohms
- PCB dimensions: 105 x 70mm / 4,1 x 2,75"

modifications reserved

1. Assembly (Skipping this can lead to troubles !)

Ok, so we have your attention. These hints will help you to make this project successful. Read them carefully.

1.1 Make sure you have the right tools:

- A good quality soldering iron (25-40W) with a small tip.
- Wipe it often on a wet sponge or cloth, to keep it clean; then apply solder to the tip, to give it a wet look. This is called 'thinning' and will protect the tip, and enables you to make good connections. When solder rolls off the tip, it needs cleaning.
- Thin raisin-core solder. Do not use any flux or grease.
- A diagonal cutter to trim excess wires. To avoid injury when cutting excess leads, hold the lead so they cannot fly towards the eyes.
- Needle nose pliers, for bending leads, or to hold components in place.
- Small blade and Phillips screwdrivers. A basic range is fine.

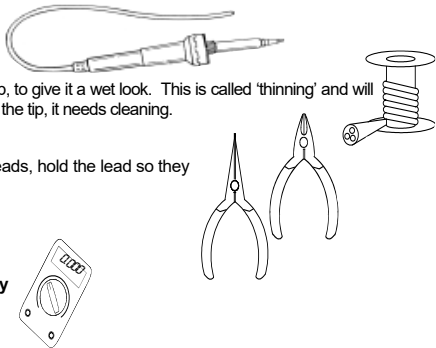

For some projects, a basic multi-meter is required, or might be handy

1.2 Assembly Hints :

- ⇒ Make sure the skill level matches your experience, to avoid disappointments.
- ⇒ Follow the instructions carefully. Read and understand the entire step before you perform each operation.
- ⇒ Perform the assembly in the correct order as stated in this manual
- ⇒ Position all parts on the PCB (Printed Circuit Board) as shown on the drawings.
- ⇒ Values on the circuit diagram are subject to changes.
- ⇒ Values in this assembly guide are correct*
- ⇒ Use the check-boxes to mark your progress.
- ⇒ Please read the included information on safety and customer service

* Typographical inaccuracies excluded. Always look for possible last minute manual updates, indicated as 'NOTE' on a separate leaflet.

1.3 Soldering Hints :

1- Mount the component against the PCB surface and carefully solder the leads

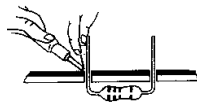

2- Make sure the solder joints are cone-shaped and shiny

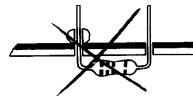
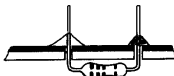

3- Trim excess leads as close as possible to the solder joint



REMOVE THEM FROM THE TAPE ONE AT A TIME !

DO NOT BLINDLY FOLLOW THE ORDER OF THE COMPONENTS ONTO THE TAPE. ALWAYS CHECK THEIR VALUE ON THE PARTS LIST!

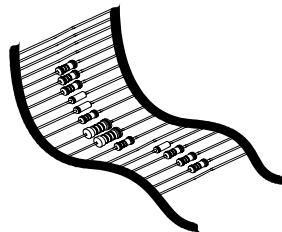

1. Zenerdiodes. Watch the polarity !

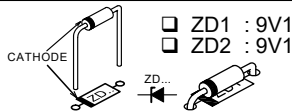

2. Diodes. Watch the polarity !

- D1 : 1N4007
- D2 : 1N4007
- D3 : 1N4007
- D4 : 1N4007

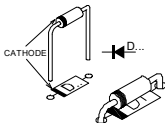

3. Resistors

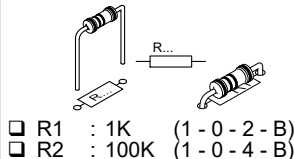

Hint for R2 and R4:

To weaken the input (divide)

E.g. to connect the input with an amplifier output.

Choose an inferior value for R2 and R4.

The dividing factor = $(R1/R2) + 1$

E.g. a value of 100Ω for RD (R2 and R4) will divide the input by 11.

- R3 : 1K (1 - 0 - 2 - B)
- R4 : 100K (1 - 0 - 4 - B)
- R5 : 10 (1 - 0 - 0 - B)
- R6 : 10 (1 - 0 - 0 - B)
- R7 : 1K (1 - 0 - 2 - B)
- R8 : 1K (1 - 0 - 2 - B)
- R9 : 3K3 (3 - 3 - 2 - B)
- R10 : 1K (1 - 0 - 2 - B)
- R11 : 1K (1 - 0 - 2 - B)
- R12 : 10 (1 - 0 - 0 - B)
- R13 : 3K3 (3 - 3 - 2 - B)
- R14 : 3K3 (3 - 3 - 2 - B)
- R15 : 10K (1 - 0 - 3 - B)

- R16 : 10K (1 - 0 - 3 - B)
- R17 : 10K (1 - 0 - 3 - B)
- R18 : 10K (1 - 0 - 3 - B)
- R19 : 10K (1 - 0 - 3 - B)
- R20 : 10K (1 - 0 - 3 - B)

Hint for R21 to R24

Modify the resistances marked RF and RA to increase the input sensitivity (more amplification).

The formula is:

$$\text{amplification} = (RF/RA) + 1$$

E.g. to double the amplification because the input of the connecting device is too weak, mount 100K for RF (R22 and R23).

- R21 : 100K (1 - 0 - 4 - B)
- R22 : 1K (1 - 0 - 2 - B)
- R23 : 1K (1 - 0 - 2 - B)
- R24 : 100K (1 - 0 - 4 - B)

4. IC sockets, Watch the position of the notch!

- IC1 : 8p
- IC2 : 8p

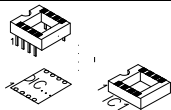

5. Capacitors.

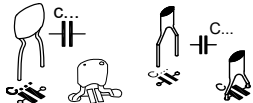

- C1 : 15pF (15)
- C2 : 15pF (15)
- C3 : 100pF (101)
- C4 : 100pF (101)
- C5 : 4,7nF (472)
- C6 : 4,7nF (472)
- C7 : 4,7nF (472)
- C8 : 4,7nF (472)
- C9 : 47nF (473)
- C10 : 47nF (473)

- C11 : 47nF (473)
- C12 : 47nF (473)
- C13 : 47nF (473)
- C14 : 47nF (473)
- C15 : 47nF (473)
- C16 : 47nF (473)

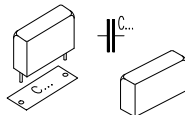

- C17 : 1µF / 63V
- C18 : 1µF / 63V

6. LED. Watch the polarity !

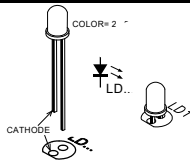

- LD1 : 5mm Red "Power"

7. Transistors

- T1 : BC547
- T2 : BC557

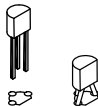

8. Terminal block

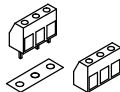

- SK1 : 3p AC input

9. Electrolytic capacitors

- C19 : 47µF
- C20 : 47µF
- C21 : 220µF
- C22 : 220µF

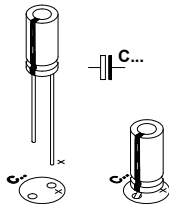

10. Dual RCA Jacks

- SK2 : input
- SK3 : output

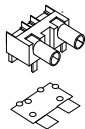

11. Potentiometers

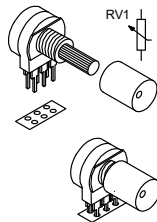

- RV1: **A** 50K (Volume)
- RV2: **B** 50K (Bass)
- RV3: **B** 50K (Treble)

12. Test

Connect a 2 x 12V / min. 100mA transformer with power connector SK1 (e.g. our 212007C). This is a 2 x 12V 3-wire transformer, 1 wire is the common 0 and generally of another colour.

A transformer without connecting wires will be marked 12 – 0 – 12.

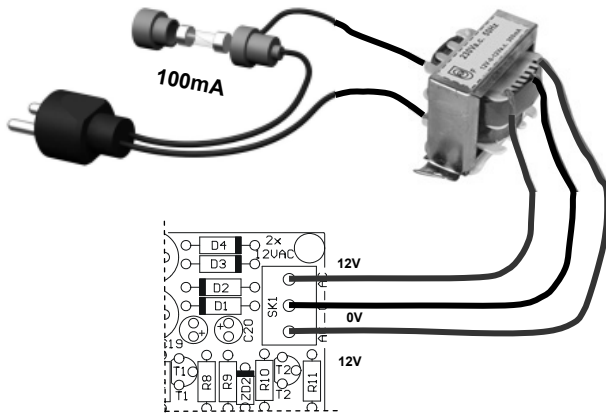

Connect the mains voltage to the transformer; mount a 100mA security fuse in series with the transformer. Use a high-quality power cord and plug for the connection to the mains.

When the transformer is live, the LED will light.

- Disconnect from mains.
- Mount the ICs into the socket (mind the position of the notch)
- Reconnect the mains.
- Check if the LED lights.
- Connect a device with the input e.g. MP3 player, CD player.
- Connect the output with a power amplifier.
- Turn down the volume to its minimum.
- Switch on the power amplifier.

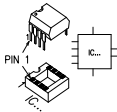

Hint: you can also connect headphones instead of a power amplifier. You can use connections GND-TPR-TPL; GND is the ground.

13. Building into a enclosure

To avoid hum, it is recommended to mount the K8084 and the transformer into a Metal housing.

Drill the holes for the connections and the potentiometers.

 **Hint:** You can drill the holes for the knobs or the potentiometers and mount the knob afterwards.

1 hole in the print (next to RV3) is provided to connect the earthing to the housing through the metal spacers or bolts.

Hint:

 Mount the transformer as far away as possible from the circuit to avoid humming.

 It is recommended to leave this circuit under voltage; disconnect the voltage only when not in use for a long time. Always switch off the power amplifier first before switching off the preamplifier.

15. Schematic diagram

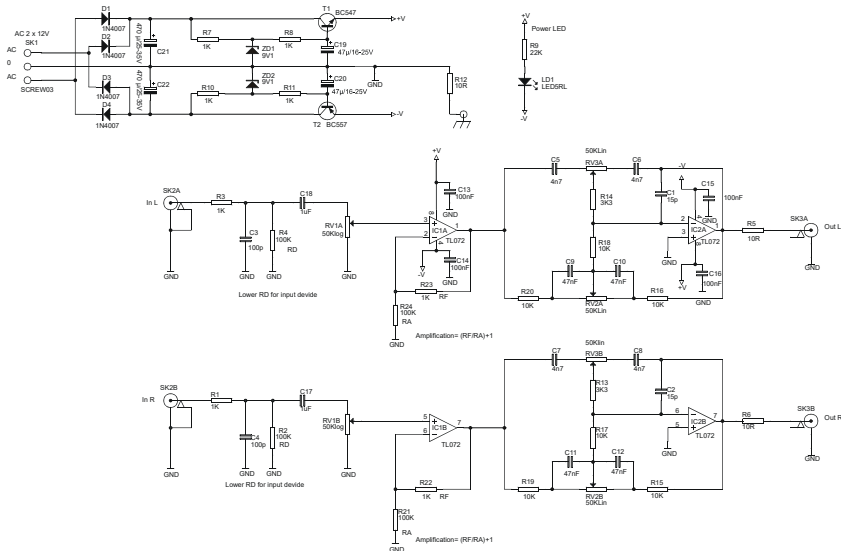



VELLEMAN NV
Legen Heirweg 33, B-9890 GAVERE
Belgium (Europe)

 @velleman_RnD

