

Total solder points: 313

Difficulty level: *beginner* 1 2 3 4 5 *advanced*

USB Experiment interface board

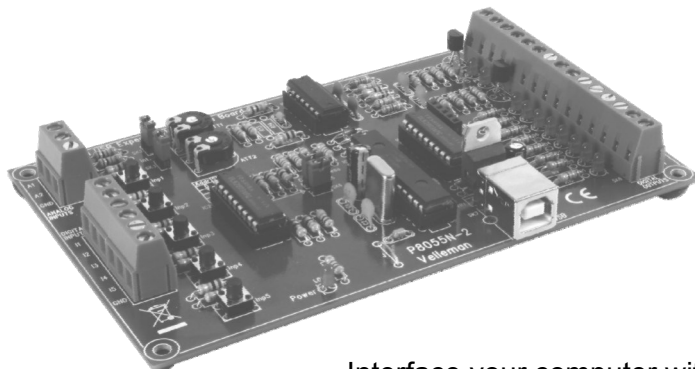

K8055N

Interface your computer with the world using 5 digital in- and 8 outputs, 2 analogue in- and outputs.

General - Algemeen - En général - Allgemein - Generalidades



- UK** See the product page on our website for the latest available software & manual translation
- NL** Download de laatste beschikbare software en vertaalde handleiding op de productpagina van onze website.
- FR** Consultez la fiche technique sur notre site web pour la toute dernière version de logiciel et la traduction du mode d'emploi.
- D** Eine aktuelle Version der Software und der deutschen Bedienungsanleitung finden Sie auf der Produktseite unserer Website
- ES** Para descargarse el manual del usuario en español y el software más recientes, consulte la página del producto en nuestra web.

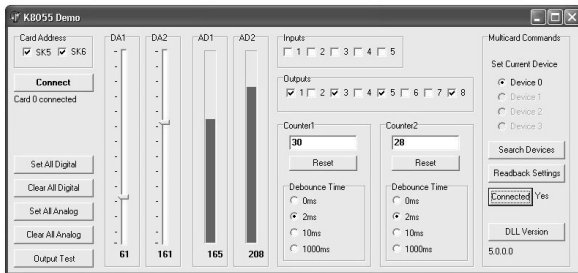
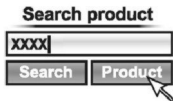

Minimum system requirements:

- ☑ 1 GHz or faster 32-bit (x86) or 64-bit (x64) processor
- ☑ USB1.1 or higher connection
- ☑ Windows XP or later

Specifications

- ☑ 5 digital inputs (0= ground, 1= open) (on board test buttons provided)
- ☑ 2 analogue inputs with attenuation and amplification option (internal test +5V provided)
- ☑ 8 digital open collector output switches (max. 50V/100mA) (on board LED indication)
 - × 2 analogue outputs:
 - × 0 to 5V, output resistance 1K5
- ☑ PWM 0 to 100% open collector outputs max 100mA / 40V (on board LED indication)
- ☑ up to 4 cards can be connected to PC
- ☑ general conversion time: 2ms per command
- ☑ uses Microsoft® human interface device (HID) driver, no external driver required.
- ☑ diagnostic software, examples and DLL are downloadable via our website
- ☑ power supply through USB: approx. 70mA
- ☑ dimensions: 145 x 89 x 20mm / 5.7 x 3.5 x 0.8"

1. Assembly (Skipping this can lead to troubles !)

Ok, so we have your attention. These hints will help you to make this project successful. Read them carefully.

1.1 Make sure you have the right tools:

- A good quality soldering iron (25-40W) with a small tip.
- Wipe it often on a wet sponge or cloth, to keep it clean; then apply solder to the tip, to give it a wet look. This is called 'thinning' and will protect the tip, and enables you to make good connections. When solder rolls off the tip, it needs cleaning.
- Thin rosin-core solder. Do not use any flux or grease.
- A diagonal cutter to trim excess wires. To avoid injury when cutting excess leads, hold the lead so they cannot fly towards the eyes.
- Needle nose pliers, for bending leads, or to hold components in place.
- Small blade and Phillips screwdrivers. A basic range is fine.

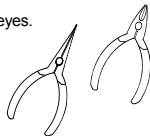

For some projects, a basic multi-meter is required, or might be handy

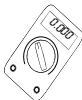

1.2 Assembly Hints :

- ⇒ Make sure the skill level matches your experience, to avoid disappointments.
- ⇒ Follow the instructions carefully. Read and understand the entire step before you perform each operation.
- ⇒ Perform the assembly in the correct order as stated in this manual
- ⇒ Position all parts on the PCB (Printed Circuit Board) as shown on the drawings.
- ⇒ Values on the circuit diagram are subject to changes, the values in this assembly guide are correct*
- ⇒ Use the check-boxes to mark your progress.
- ⇒ Please read the included information on safety and customer service

* Typographical inaccuracies excluded. Always look for possible last minute manual updates, indicated as 'NOTE' on a separate leaflet.

1.3 Soldering Hints :

1- Mount the component against the PCB surface and carefully solder the leads

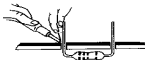

2- Make sure the solder joints are cone-shaped and shiny



3- Trim excess leads as close as possible to the solder joint



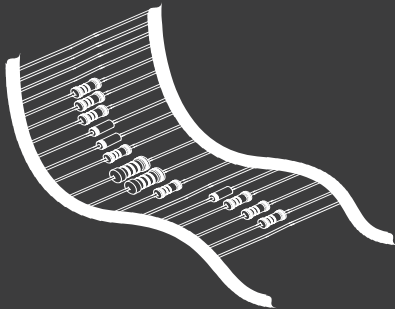

REMOVE THEM FROM THE TAPE ONE AT A TIME !

Included in
this kit



2. RESISTOR

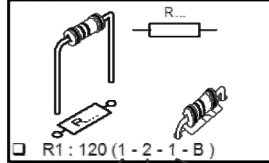

COLOUR	COLOUR NAME	1ST DIGIT/ STRIPE	2ND DIGIT/ STRIPE	3RD DIGIT/ STRIPE	MULTIPLIER STRIPE	TOLE 4TH:
	BLACK	0	0	0	x1	1%
	BROWN	1	1	1	x10	
	RED	2	2	2	x100	
	ORANGE	3	3	3	x1.000	
	YELLOW	4	4	4	x10.000	
	GREEN	5	5	5	x100.000	
	BLUE	6	6	6	x1.000.000	

**DO NOT BLINDLY FOLLOW THE ORDER OF THE COMPONENTS ONTO THE TAPE.
ALWAYS CHECK THEIR VALUE ON THE PARTS LIST!**

1. Jumper

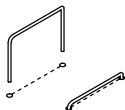
 J

2. Diodes, check the polarity !

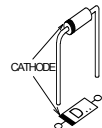
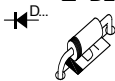
 D1: 1N4148
 D2: 1N4148

3. Resistors

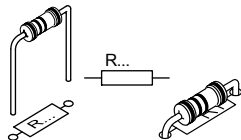
 R1 : 680 (6-8-1-B)
 R2 : 680 (6-8-1-B)

<input type="checkbox"/> R3 : 680	(6-8-1-B)	<input type="checkbox"/> R31 : 10K	(1-0-3-B)
<input type="checkbox"/> R4 : 680	(6-8-1-B)	<input type="checkbox"/> R32 : 10K	(1-0-3-B)
<input type="checkbox"/> R5 : 680	(6-8-1-B)	<input type="checkbox"/> R33 : 10K	(1-0-3-B)
<input type="checkbox"/> R6 : 680	(6-8-1-B)	<input type="checkbox"/> R34 : 10K	(1-0-3-B)
<input type="checkbox"/> R7 : 680	(6-8-1-B)	<input type="checkbox"/> R35 : 10K	(1-0-3-B)
<input type="checkbox"/> R8 : 680	(6-8-1-B)	<input type="checkbox"/> R36 : 10K	(1-0-3-B)
<input type="checkbox"/> R9 : 680	(6-8-1-B)	<input type="checkbox"/> R37 : 10K	(1-0-3-B)
<input type="checkbox"/> R10 : 680	(6-8-1-B)	<input type="checkbox"/> R38 : 10K	(1-0-3-B)
<input type="checkbox"/> R11 : 680	(6-8-1-B)	<input type="checkbox"/> R39 : 10K	(1-0-3-B)
<input type="checkbox"/> R12 : 1K	(1-0-2-B)	<input type="checkbox"/> R40 : 10K	(1-0-3-B)
<input type="checkbox"/> R13 : 1K	(1-0-2-B)	<input type="checkbox"/> R41 : 10K	(1-0-3-B)
<input type="checkbox"/> R14 : 1K	(1-0-2-B)	<input type="checkbox"/> R42 : 10K	(1-0-3-B)
<input type="checkbox"/> R15 : 1K	(1-0-2-B)	<input type="checkbox"/> R43 : 10K	(1-0-3-B)
<input type="checkbox"/> R16 : 1K	(1-0-2-B)	<input type="checkbox"/> R44 : 10K	(1-0-3-B)
<input type="checkbox"/> R17 : 1K	(1-0-2-B)	<input type="checkbox"/> R45 : 10K	(1-0-3-B)
<input type="checkbox"/> R18 : 1K	(1-0-2-B)	<input type="checkbox"/> R46 : 10K	(1-0-3-B)
<input type="checkbox"/> R19 : 1K1	(1-1-0-1)	<input type="checkbox"/> R47 : 10K	(1-0-3-B)
<input type="checkbox"/> R20 : 2K2	(2-2-2-B)	<input type="checkbox"/> R48 : 10K	(1-0-3-B)
<input type="checkbox"/> R21 : 2K2	(2-2-2-B)	<input type="checkbox"/> R49 : 15K	(1-5-3-B)
<input type="checkbox"/> R22 : 2K2	(2-2-2-B)	<input type="checkbox"/> R50 : 15K	(1-5-3-B)
<input type="checkbox"/> R23 : 2K2	(2-2-2-B)	<input type="checkbox"/> R51 : 100K	(1-0-4-B)
<input type="checkbox"/> R24 : 9K1	(9-1-0-1)	<input type="checkbox"/> R52 : 100K	(1-0-4-B)
<input type="checkbox"/> R25 : 9K1	(9-1-0-1)		
<input type="checkbox"/> R26 : 10K	(1-0-3-B)		
<input type="checkbox"/> R27 : 10K	(1-0-3-B)		
<input type="checkbox"/> R28 : 10K	(1-0-3-B)		
<input type="checkbox"/> R29 : 10K	(1-0-3-B)		
<input type="checkbox"/> R30 : 10K	(1-0-3-B)		

**R53 & R54 are optional
and should not be mounted**

4. Ceramic Capacitors



- C7 : 100nF (104, 0.1, u1)
- C8 : 100nF (104, 0.1, u1)
- C9 : 100nF (104, 0.1, u1)

5. Ceramic Capacitors

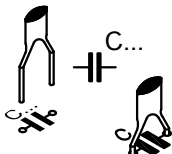

- C1 : 27pF (27)
- C2 : 27pF (27)
- C3 : 22nF (223)
- C4 : 22nF (223)
- C5 : 22nF (223)
- C6 : 22nF (223)

6. LED's. Watch the polarity!

- LD1
- LD2
- LD3
- LD4
- LD5
- LD6
- LD7
- LD8
- LD9
- LD10
- LD11

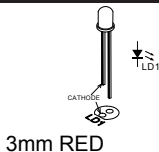

3mm RED



7. Push buttons

- SW1
- SW2
- SW3
- SW4
- SW5

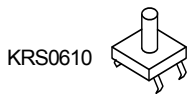

KRS0610

8. IC sockets. Watch the position of the notch!

- IC1 : 14P
- IC2 : 18P
- IC3 : 28P
- IC4 : 18P

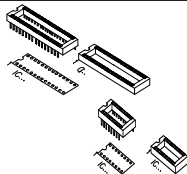

9. Potentiometer

- RV1 : 100K
- RV2 : 100K

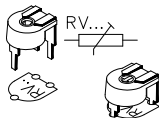

10. Transistors

- T1 : BC337
- T2 : BC337

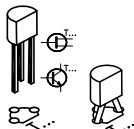

11. Header

- SK2 : 2P
- SK3 : 2P

- SK5 : 2P
- SK6 : 2P

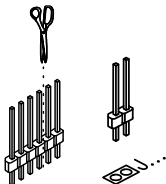

12. USB connector

- SK7: CC089

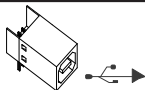
13. Electrolytic capacitor.
Watch the polarity !

- C10 : 4,7 μ F
- C11 : 10 μ F

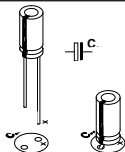

14. Quartz crystal

- X1 : 4MHz

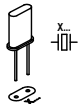

15. Screw connectors

- SK1 : 3P

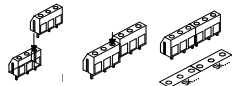

- SK4 : 2 x 3P

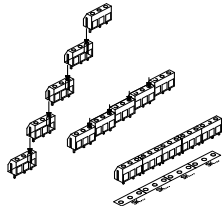

- SK8 : 5 x 3P

16. Voltage regulator

- VR1: LM317

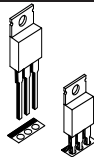
17. IC's. Watch the position
of the notch!

- IC1 : TLV274IN
- IC2 : ULN2803
- IC3 : VK8055
(Programmed PIC18F24J50)
- IC4 : ULN2803

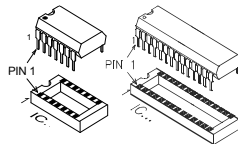

18. GAIN FACTOR

The analogue inputs A1 and A2 have a standard range of 0 ~ +5Vdc. To use them externally, remove the jumper caps on SK2 and SK3. The internal 5V voltage source can only be used for testing purposes. When the input voltage is too low you can amplify it x4 / x15.

A gain of x4 requires a resistance of 3K3 for R53 (input signal 1) and for R54 (input signal 2). A x15 gain requires a resistance of 820ohm.

When the gain is set to e.g. x4, the max. input voltage falls inversely proportional to 1,25V.

If you want a different gain factor you can calculate it quite easily using the following formula :

$$\text{Gain A1} = 1 + (R44/R53) \quad \text{Gain A2} = 1 + (R43/R54)$$

19. Rubber feet

Mount the rubber feet on the solder side of the PCB, see fig 1.0.

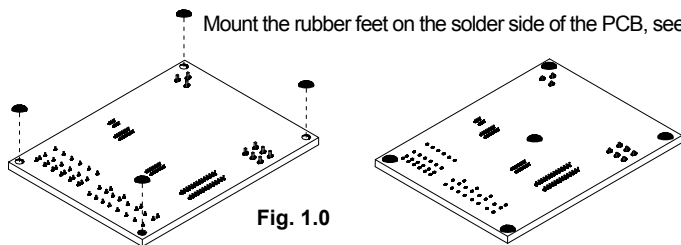
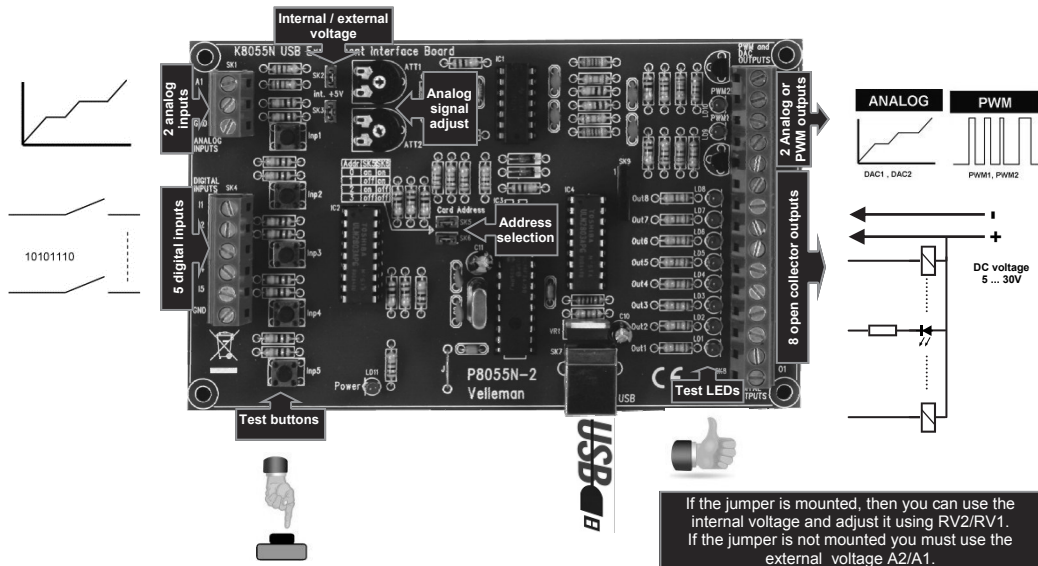

Fig. 1.0

20. Connection / settings



Select the correct address in the test program**DIGITAL OUTPUTS :**

8 open collector contacts, to be connected with suitable inputs.

These exits function as 'dry contact points': you need an external voltage to control a component such as a LED or a relay switch.

ANALOGUE OUTPUTS :

- 2 analogue outputs with an output voltage between 0 and +5V (impedance 1K5).
- 2 PWM outputs with a pulse width modulation between 0 and 100%.

A fixed PWM frequency (46.86KHz) is used.

👉 **REMARK:** the analogue outputs and PWM outputs are always activated /deactivated together.

21. Test procedure

The demo software makes it easy to experiment. **Start** by selecting the address : tick off SK5 and/or SK6 (see address selection).

ATTENTION : Execute these settings before connecting the kit with the computer or before booting the computer.

- * Connect the USB cable.
- * LED LD3 'Power' lights up if the connection has been executed properly.
- * After startup LD8 (output 8) will flash momentarily to indicate that the circuit works as it should.
- * Start the program 'K8055_Demo.exe'.

SK5	SK6	ADDRESS
ON	ON	0
OFF	ON	1
ON	OFF	2
OFF	OFF	3

! Next press the 'connect' button to connect the K8055 with the computer.

The message "Card x connected" is displayed if the connection is successful

You can now simulate the inputs via push buttons Inp1 through Inp5. The matching check box remains ticked off as long as you keep one of the push buttons pressed down.

Always tick off the check box for the matching output if you wish to test a digital output.

You can also conduct this procedure automatically : press the 'output test' button or activate all outputs with the 'Set all digital' button. Press the 'output test' button to test all digital outputs automatically.

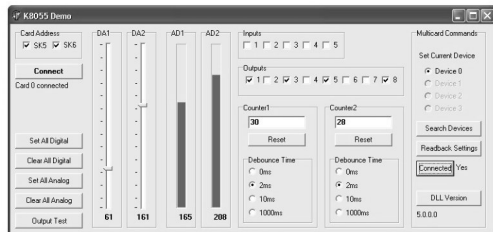

Test the analogue outputs with the 'set all analog' button and modify the output voltage with DA1 & DA2. Counter 1 & 2 are hardware integrated 16-bit counters, they are triggered by INP1 & INP2. You can test the counter with push buttons Inp1 and Inp2 : the counter adds 1 every time one of these two buttons is pressed. The debouncing control allows you to determine the reaction time of the counter (0ms - 2ms - 10ms - 1000ms).

You can use the internal analogue voltage to simulate the analogue input via potentiometers ATT1 (RV1) & ATT2 (RV2). The scroll bars AD1 & AD2 change on the screen whenever you adjust the position of the potentiometers. The "digital" value (0 to 255) of this internal analogue voltage can be read directly under the scroll bars.

22. Connection Scheme

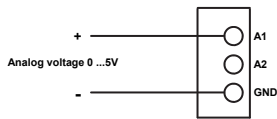

Analog input example

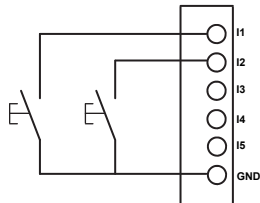

Digital input example

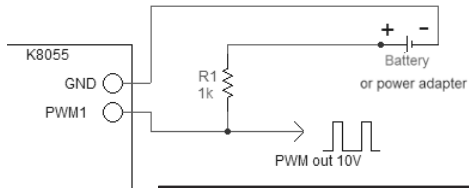

PWM output example

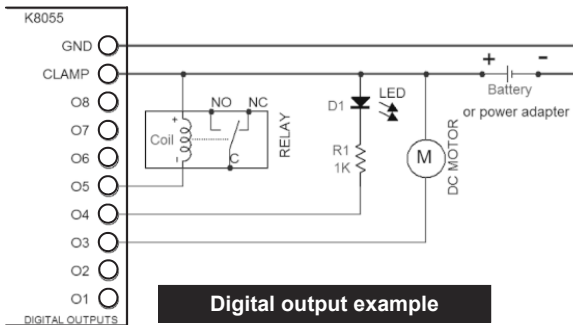

Digital output example

23. PCB

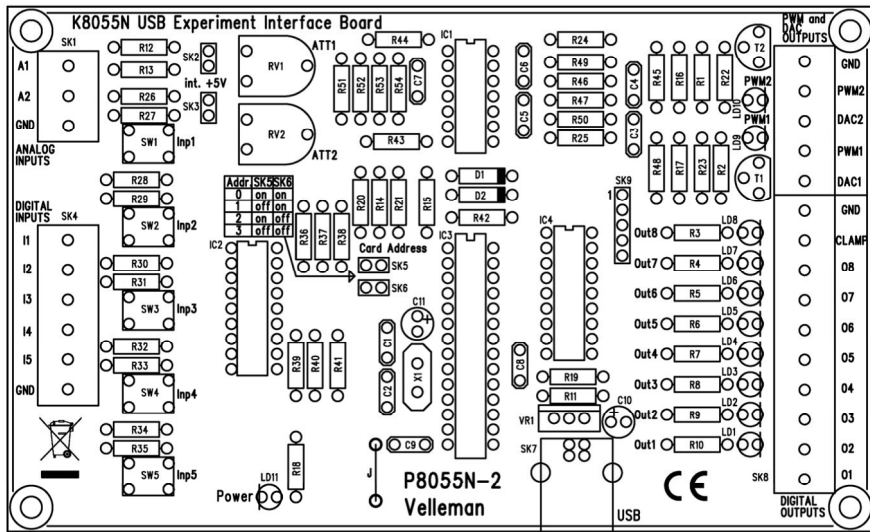

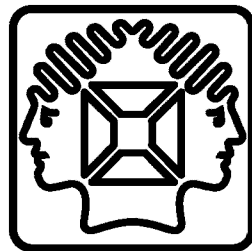

VELLEMAN NV
Legen Heirweg 33, B-9890 GAVERE
Belgium (Europe)