

Total solder points: 115
Difficulty level: *beginner* 1 2 3 4 5 *advanced*

4 CHANNEL RUNNING LIGHT

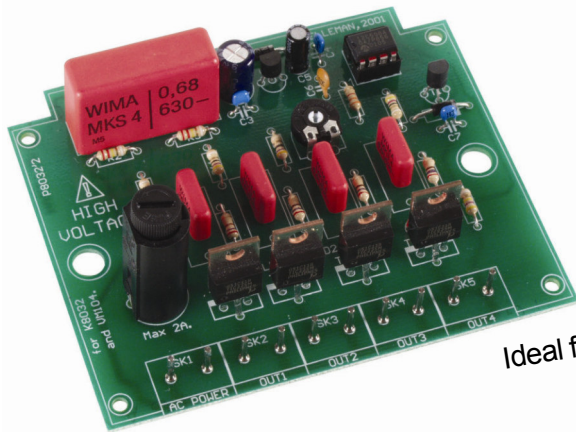

K8032

*Ideal for creating disco light effects, light speed adjustable.
Suited for inductive loads.*

Features:

- ☑ Adjustable speed.
- ☑ Suited for inductive loads.
- ☑ 4 channels with LED indicator.
- ☑ Ideal for disco effects.
- ☑ Noise suppressed according to EN55015.

Specifications:

- AC Power : 110 to 240 VAC.
- Auto frequency detection : 50/60Hz.
- Max load per channel 2A : 200W (110 - 125VAC)
400W (220 - 240VAC)
- Adjustable speed : 0,2 to 3Hz.
- Dimensions : 100 x 82 x 35mm / 4 x 3,3 x 1,4"

1. Assembly (Skipping this can lead to troubles !)

Ok, so we have your attention. These hints will help you to make this project successful. Read them carefully.

1.1 Make sure you have the right tools:

- A good quality soldering iron (25-40W) with a small tip.
- Wipe it often on a wet sponge or cloth, to keep it clean; then apply solder to the tip, to give it a wet look. This is called 'thinning' and will protect the tip, and enables you to make good connections. When solder rolls off the tip, it needs cleaning.
- Thin raisin-core solder. Do not use any flux or grease.
- A diagonal cutter to trim excess wires. To avoid injury when cutting excess leads, hold the lead so they cannot fly towards the eyes.
- Needle nose pliers, for bending leads, or to hold components in place.
- Small blade and Phillips screwdrivers. A basic range is fine.

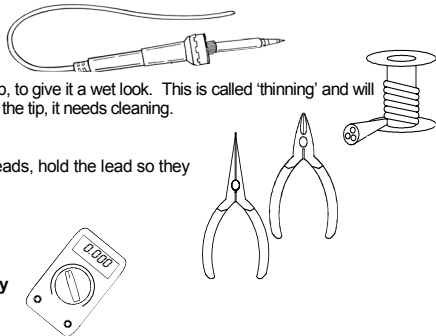

 **For some projects, a basic multi-meter is required, or might be handy**

1.2 Assembly Hints :

- ⇒ Make sure the skill level matches your experience, to avoid disappointments.
 - ⇒ Follow the instructions carefully. Read and understand the entire step before you perform each operation.
 - ⇒ Perform the assembly in the correct order as stated in this manual
 - ⇒ Position all parts on the PCB (Printed Circuit Board) as shown on the drawings.
 - ⇒ Values on the circuit diagram are subject to changes.
 - ⇒ Values in this assembly guide are correct*
 - ⇒ Use the check-boxes to mark your progress.
 - ⇒ Please read the included information on safety and customer service
- * Typographical inaccuracies excluded. Always look for possible last minute manual updates, indicated as 'NOTE' on a separate leaflet.

1.3 Soldering Hints :

1- Mount the component against the PCB surface and carefully solder the leads

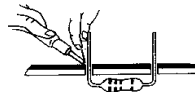

2- Make sure the solder joints are cone-shaped and shiny

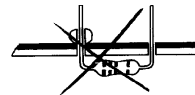
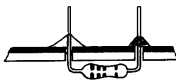

3- Trim excess leads as close as possible to the solder joint

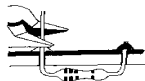

REMOVE THEM FROM THE TAPE ONE AT A TIME !

**AXIAL COMPONENTS ARE TAPED IN THE
CORRECT MOUNTING SEQUENCE !**

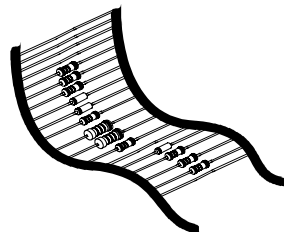

 You will find the colour code for the resistances and the LEDs in the HALG (general manual) and on our website: <http://www.velleman.be/common/service.aspx>

1. Zener diode. Watch the polarity !

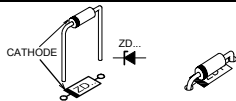

ZD1 : 12V0

2. Diodes. Watch the polarity !

D1 : 1N4007
 D2 : 1N4007

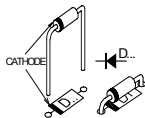

3. 1/4W Resistors

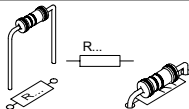

R4 : 3K3 (3 - 3 - 2 - B)
 R6 : 270 (2 - 7 - 1 - B)
 R7 : 270 (2 - 7 - 1 - B)

R8 : 270 (2 - 7 - 1 - B)
 R9 : 270 (2 - 7 - 1 - B)

4. Metal film resistors

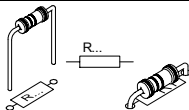

R2 : 220K (2 - 2 - 4 - B - 9)
 R3 : 220K (2 - 2 - 4 - B - 9)
 R5 : 470K (4 - 7 - 4 - B - 9)
 R10 : 47 (4 - 7 - 0 - B - 9)
 R11 : 47 (4 - 7 - 0 - B - 9)
 R12 : 47 (4 - 7 - 0 - B - 9)
 R13 : 47 (4 - 7 - 0 - B - 9)

5. IC socket. Watch the position of the notch!

IC1 : 8p

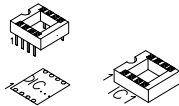

6. Capacitors

C3 : 100nF (104)
 C4 : 100nF (104)
 C6 : 100pF (101)
 C7 : 10nF (103)

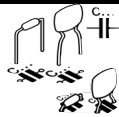

7. LEDs. Watch the polarity!

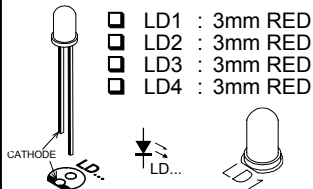

8. Trim potentiometer

RV1 : 100K

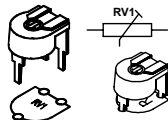

9. Transistor.

- T1 : BC547B

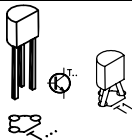

10. Voltage regulator

- VR1 :UA78L05

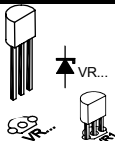

11. 1W Resistors

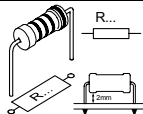

- R1 : 220 (2 - 2 - 1 - B)

12. Capacitors

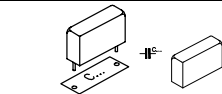

- C8 : 10nF / 600V
- C9 : 10nF / 600V
- C10 : 10nF / 600V
- C11 : 10nF / 600V

13. PCB tabs.

- SK1 : Power (2x)
- SK2 : OUT1 (2x)
- SK3 : OUT2 (2x)
- SK4 : OUT3 (2x)
- SK5 : OUT4 (2x)

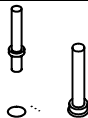

14. Electrolytic Capacitors. Watch the polarity !

- C2 : 220µF / 25V
- C5 : 10µF / 35V

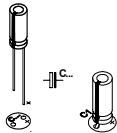

15. Triacs.

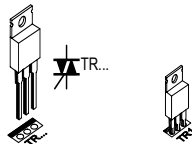

- TR1 : TIC225M
- TR2 : TIC225M
- TR3 : TIC225M
- TR4 : TIC225M

The back side corresponds to the thick line!

16. Fuse holder + fuse

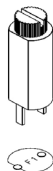

- F1 : 2A (Slow)

17. Capacitor

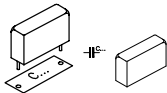

- C1 : 680nF / 600V

18. IC. Watch the position of the notch!

- IC1 : VK8032

Programmed PIC12C508A

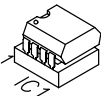

Inspect the complete assembly once more before applying power to the unit !

19. Hook - up & use

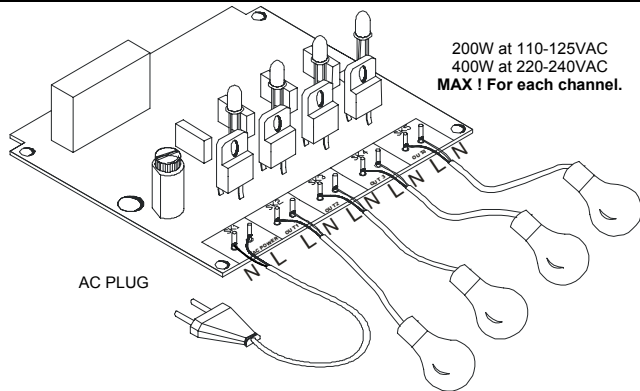

200W at 110-125VAC
400W at 220-240VAC
MAX ! For each channel.

- Solder an AC cable to the SK1 pins (AC Power).
- Solder the cables of each lampholder to the appropriate pins.

As this kit is shipped to different countries, there is no AC plug supplied. You will need to attach a plug that matches your electrical system. You can adjust the running speed by turning the trimmer "RV1". Each LED will light up when a channel is activated.

20. PCB

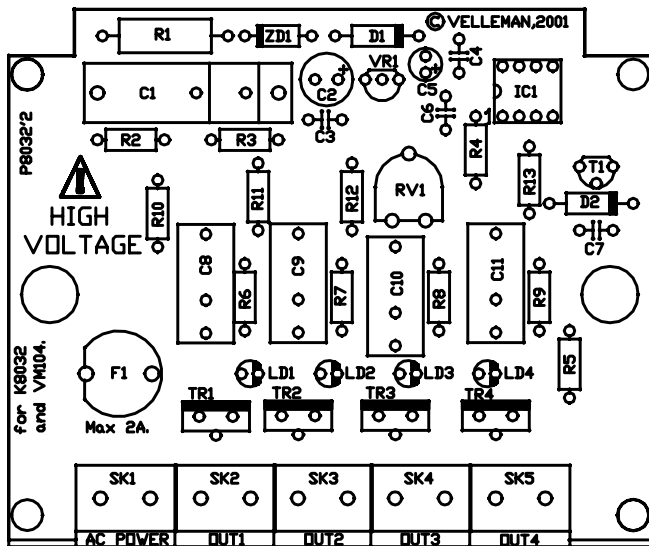

21. Diagram

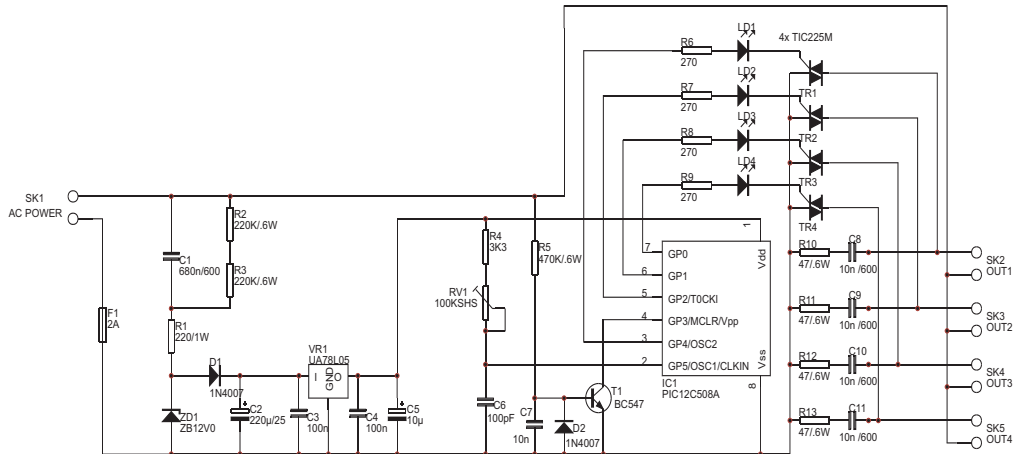



Modifications and typographical errors reserved
© Velleman Components nv.
H8032IP - 2004 - ED1

