

Total solder points: 144

Difficulty level: *beginner* 1 2 3 4 5 *advanced*

DC CONTROLLED DIMMER



K8064

Simple brightness adjustment
by means of a DC voltage.



This dimmer is a practical circuit enabling you to adjust the brightness of a lamp or a group of lamps via an adjustable direct tension. This tension can have various sources e.g. an analogue output of our K8000, K8055, VM110, ... The dimmer can use both resistive loads (e.g. light bulb) and inductive loads (halogen lighting).

Use a conventional (wirewound) transformer for low voltage halogen lighting (12V). Most electronic transformers are not compatible with this dimmer. For safety reasons, the adjustment voltage has been optically isolated from the supply voltage. Applications: stage lighting, domotics, etc...

Features:

- ☑ Simple brightness adjustment by means of a DC voltage.
- ☑ Optically isolated adjust input.
- ☑ Pre-set adjustment for full brightness.
- ☑ Suitable for incandescent lamps, mains voltage halogen lighting and low voltage halogen lighting in combination with a conventional transformer.
- ☑ "Soft start" feature to ensure lamp longevity.
- ☑ Transformer protection in case of defective light sources.
- ☑ LED status indication.
- ☑ Compatible with our computer interface cards: K8000, K8055, VM110.

Specifications:

- Adjustment voltage: 0 to 12Vdc max.
- Max. adjustment current: 2.25mA at adjustment voltage of 12V.
- Suppression of radio & TV interference according to EN55015.
- Operating voltage: 110-125V or 220-240V AC (50/60Hz).
- Max. load: 750W/230V or 375W/110V, 0-98% adjustable.
- Max. phase shift with inductive load: 30°.
- PCB dimensions: 90 x 75 x 40mm



1. Assembly (Skipping this can lead to troubles !)

Ok, so we have your attention. These hints will help you to make this project successful. Read them carefully.

1.1 Make sure you have the right tools:

- A good quality soldering iron (25-40W) with a small tip.
- Wipe it often on a wet sponge or cloth, to keep it clean; then apply solder to the tip, to give it a wet look. This is called 'thinning' and will protect the tip, and enables you to make good connections. When solder rolls off the tip, it needs cleaning.
- Thin raisin-core solder. Do not use any flux or grease.
- A diagonal cutter to trim excess wires. To avoid injury when cutting excess leads, hold the lead so they cannot fly towards the eyes.
- Needle nose pliers, for bending leads, or to hold components in place.
- Small blade and Phillips screwdrivers. A basic range is fine.

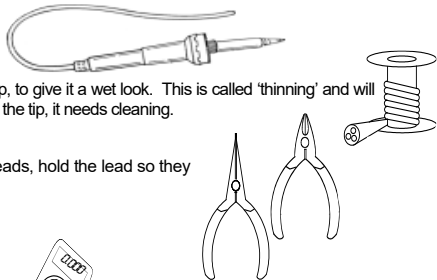

For some projects, a basic multi-meter is required, or might be handy

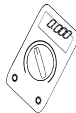

1.2 Assembly Hints :

- ⇒ Make sure the skill level matches your experience, to avoid disappointments.
 - ⇒ Follow the instructions carefully. Read and understand the entire step before you perform each operation.
 - ⇒ Perform the assembly in the correct order as stated in this manual
 - ⇒ Position all parts on the PCB (Printed Circuit Board) as shown on the drawings.
 - ⇒ Values on the circuit diagram are subject to changes.
 - ⇒ Values in this assembly guide are correct*
 - ⇒ Use the check-boxes to mark your progress.
 - ⇒ Please read the included information on safety and customer service
- * Typographical inaccuracies excluded. Always look for possible last minute manual updates, indicated as 'NOTE' on a separate leaflet.

1.3 Soldering Hints :

1- Mount the component against the PCB surface and carefully solder the leads

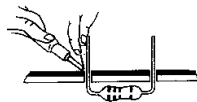

2- Make sure the solder joints are cone-shaped and shiny

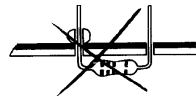
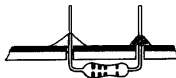

3- Trim excess leads as close as possible to the solder joint

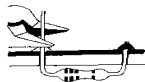

REMOVE THEM FROM THE TAPE ONE AT A TIME !

DO NOT BLINDLY FOLLOW THE ORDER OF THE COMPONENTS ONTO THE TAPE. ALWAYS CHECK THEIR VALUE ON THE PARTS LIST!

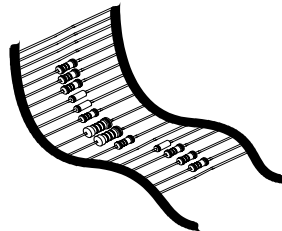

1. Jumpers

J : 3x

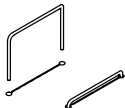

2. Diodes. Watch the polarity !

- D1 : 1N4148
- D2 : **1N4007**
- D3 : 1N4148
- D4 : 1N4148

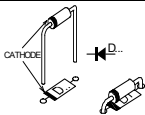

3. Zenerdiode. Watch the polarity !

ZD1 : 4V7

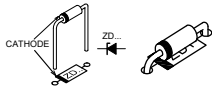

4. 1/2w (Metal film) resistors

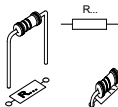

- R1 : 470K (4 - 7 - 4 - B - 9)
- R2 : 100K (1 - 0 - 4 - B - 9)
- R9 : 470K (4 - 7 - 4 - B - 9)
- R10 : 100K (1 - 0 - 4 - B - 9)
- R13 : 220 (2 - 2 - 1 - B - 9)
- R17 : 1M (1 - 0 - 5 - B - 9)

5. Resistors

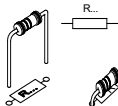

- R3 : 1K5 (1 - 5 - 2 - B)
- R4 : 1K5 (1 - 5 - 2 - B)
- R5 : 390 (3 - 9 - 1 - B)
- R6 : 4K7 (4 - 7 - 2 - B)
- R7 : 4K7 (4 - 7 - 2 - B)
- R8 : 4K7 (4 - 7 - 2 - B)

- R11 : 470K (4 - 7 - 4 - B)
- R12 : 100K (1 - 0 - 4 - B)
- R14 : 4K7 (4 - 7 - 2 - B)
- R15 : 4K7 (4 - 7 - 2 - B)
- R16 : 4K7 (4 - 7 - 2 - B)
- R18 : 33K (3 - 3 - 3 - B)
- R19 : 1K (1 - 0 - 2 - B)

6. Capacitors.

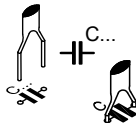

- C1 : 10nF (103)
- C2 : 15pF (15)
- C3 : 15pF (15)
- C4 : 10nF (103)
- C5 : 100nF (104)
- C6 : 100nF (104)
- C7 : 100nF (104)
- C8 : 100nF (104)
- C14 : 10nF (103)

7. LEDs. Watch the polarity!

- LD1 : 3mm Green
- LD2 : 3mm Red

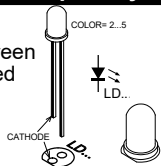

8. Zenerdiode. Watch the polarity !

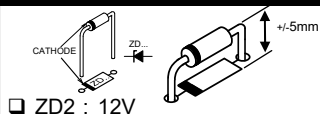

- ZD2 : 12V

9. IC socket. Watch the position of the notch!

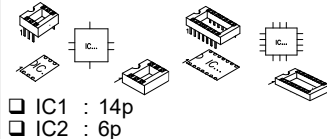

- IC1 : 14p
- IC2 : 6p

10. Resistor trimmer

- RV1 : 220K (250K)
- RV2 : 2M2 (2M5)

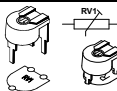

11. 1w Resistor

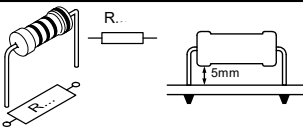

- R20 : 220 (2 - 2 - 1 - B)

12. Transistors

- T1 : BC547
- T2 : BC547

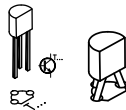

13. Voltage regulator

- VR1 : UA78L05

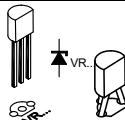

14. Capacitor.

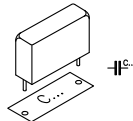

- C12 : 100nF / 250Vac

15. Electrolytic Capacitors. Watch the polarity !

- C9 : 10 μ F
- C10 : 100 μ F
- C11 : 220 μ F

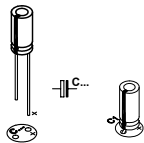

17. Crystal

- X1 : 10MHz

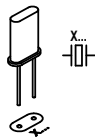

16. Terminal connectors

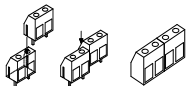

- SK1 : 2p (AC power) Pitch 7,5mm
- SK2 : 2p (Load) Pitch 7,5mm



- SK3 : 2p (Analog IN) Pitch 5mm

18. Fuse + Fuseholder

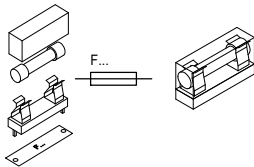

- F1 : 4A SLOW

19. Capacitor.

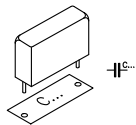

Choose operating voltage :

For 110 - 125VAC :

- C13 : 1 μ F / 250V

For 220 - 240VAC :

- C13 : 0,47 μ F / 630V

20. Coil

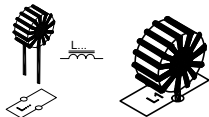

□ L1 : 1,5mH / 4A

22. IC's. Watch the position of the notch!

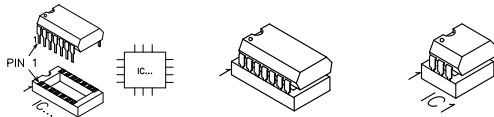

- IC1 : VK8064 (programmed PIC16F676)
- IC2 : TIL111 or 4N27

21. Triac.

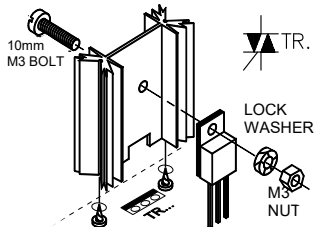

□ TR1 : TIC225M or eq.



IMPORTANT : PUT AN EXTRA THICK TIN COATING ON THE ALREADY THINNED PCB TRACKS!

23. TEST and ADJUSTMENT PROCEDURE:

Once the assembly completed, you still need to set the dimmer for your particular application. Use an adjustment voltage of 0 to 5 (or to 12V max). You can now wire the print according to the connection diagram (see page 13).

Connect the supply voltage for a brief instant. Upon activation of the device, LD1(green LED) & LD2(red LED) briefly flash together during the self-test. LD1 will flash briefly if there are no problems: 1 x in case of a mains frequency of 50Hz and 2 x for 60Hz. There is a problem if the red LED remains lit (see error messages).

- Turn RV1 fully counterclockwise and turn RV2 fully clockwise
- Set the control voltage to 0 VDC
- Apply AC power.
- Adjust RV1 (minimum level) until LD1 (green) starts flashing rapidly
- Trim RV1 just below the bulb ignition threshold
- Set your max. control voltage e.g. 10 VDC
- Adjust RV2 (maximum level) until LD1 (green) burns steadily

The circuit is now ready for use

Remark:

In order to stretch bulb life, we recommend you adjust the minimum setting in such a way that the bulb filament remains heated. This is particularly useful for theatre lighting applications

BONUS Function:

Activate the bonus function by placing a jumper wire over JP1 and JP2.

With the bonus function, the operation of the circuit is exactly the opposite of the operation under normal circumstances: the lamp burns at maximum intensity at an adjustment voltage of 0V and extinguishes at the max. adjustment voltage that has been set beforehand.

LED indications in case of normal operation:

LD1 (green LED):

- Flashes once every 5 seconds when the unit is in standby mode (lamp off).
- Flashes slowly (2x/sec) when the lamp is burning, but not when it's burning at max. intensity.
- Remains lit when the lighting burns at max. intensity.

LED indications in case of error:

When the CPU detects an error, LD1 (green) lights up continuously, whereas LD2 (red) repeatedly emits a series of flashes.

We advise you to briefly interrupt the supply voltage and evaluate the situation.

Flashes LD2	Error	Possible cause
1	Time out in the positive alternation of the mains voltage	error in voltage zero-crossing circuit (T1, ...)
2	Time out in the negative alternation of the mains voltage	error in voltage zero-crossing circuit (T1, ...)
3	Triac triggering time out	<ul style="list-style-type: none"> - Triac defective ? - Light source defective ? - T2 defective ? - Load doesn't conform to specifications ?
4	Phase shift is too great	<ul style="list-style-type: none"> - Load behaves too inductively ? - No load connected ? - No load on transformer (because of defective lamp ?) - Load not conform ?

The "MON" connection on the PCB is only used by our technical department for purposes of repair and diagnosis.

24. CONNECTION EXAMPLE

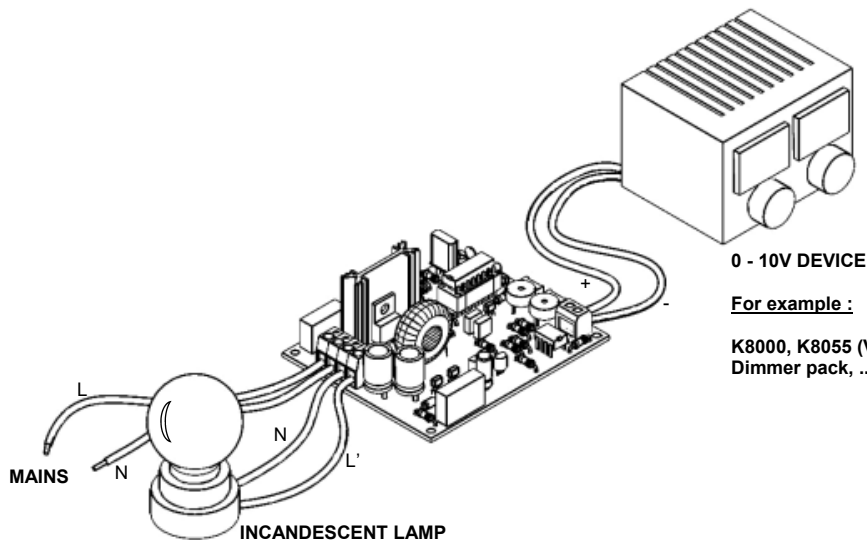

25. PCB layout.

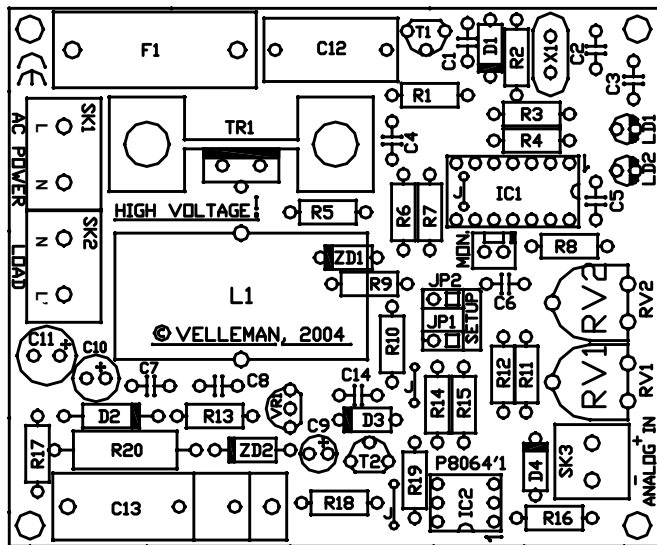



VELLEMAN NV
Legen Heirweg 33, B-9890 GAVERE
Belgium (Europe)

