

1

Resistor - Weerstand - Résistance - Widerstand - Resistencia - Motstand - Vastus - Resistenze

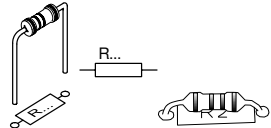

R1, R2, R3, R4:
10K

(Brown, Black, Orange) -(Bruin, Zwart, Oranje) -(Brun, Noir, Orange) -(Braun, Schwarz, Orange) -(Brun, Svart, Orange) -(Ruskea, Musta, Oranssi) -(Marrón, Negro, Naranjado) -(Castanho, Preto, Laranja) -(Marrone, Nero, Aranciato)

R5, R6, R7, R8:
1K

(Brown, Black, Red) -(Bruin, Zwart, Rood) -(Brun, Noir, Rouge) -(Braun, Schwarz, Rot) -(Brun, Svart, Röd) -(Ruskea, Musta, Punainen) -(Marrón, Negro, Rojo) -(Castanho, Preto, Encarnado) -(Marrone, Nero, Rosso)

R9, R10:
100K

(Brown, Black, Yellow) -(Bruin, zwart, Geel) -(Brun, Noir, Jaune) -(Braun, Schwarz, Gelb) -(Brun, Svart, Gul) -(Ruskea, Musta, Keltainen) -(Marrón, Negro, Amarillo) -(Castanho, Preto, Amarelo) -(Marrone, Nero, Giallo)

R11 : 0

(Black) -(Zwart) -(Noir) -(Schwarz) -(Svart) -(Musta) -(Negro) -(Preto) -(Nero)

2

DIOD

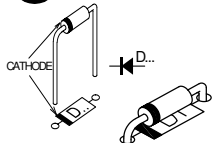

◇ D1 : BAT85
Watch the polarity !
Att. à la polarité !

3

ZENER DIODES

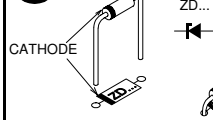

◇ ZD1 : 2V4
◇ ZD2 : 2V4
◇ ZD3 : 3V0
Watch the polarity !
Attention à la polarité !

4

IC SOCKET

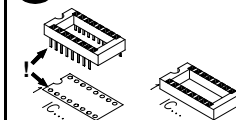

◇ IC1 : 14P
WATCH THE POSITION OF THE NOTCH !
ATTENTION A LA POSITION DE L'ENCOCHE !

5

PUSHBUTTON

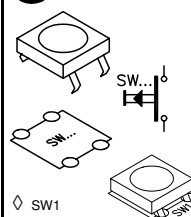

◇ SW1

6

LEDs

Watch the polarity !
Attention à la polarité !

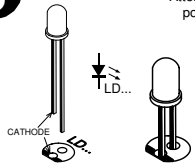

Open : red / rood / rouge / rot / röd / punainen / rojo / encarnado / rosso
Polarity OK : green / groen / vert / grün / grön / vihreä / verde
Polarity INVERTED : red / rood / rouge / rot / röd / punainen / rojo / encarnado / rosso
Short : red / rood / rouge / rot / röd / punainen / rojo / encarnado / rosso

7

TRANSISTORS

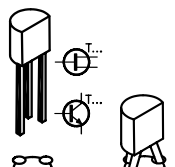

◇ T1 : BC557
◇ T2 : BC547

8

ELECTROLYTIC CAPACITORS

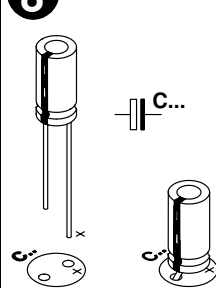

Watch the polarity !
Attention à la polarité !

◇ C1 : 47µF

9

IC SOCKET AND IC

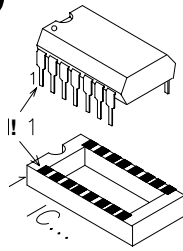

WATCH THE POSITION OF THE NOTCH !
ATTENTION A LA POSITION DE L'ENCOCHE !

◇ IC1 : LM324, LM224, LM124 or eq.

10

PREPARING THE TESTLEADS

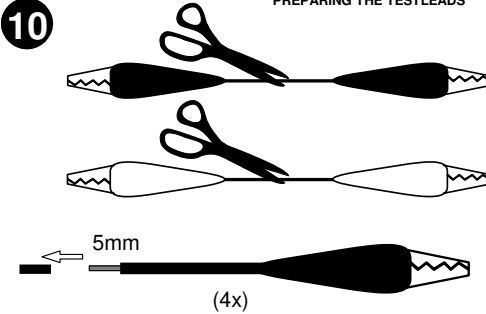

(4x)

11

CUT

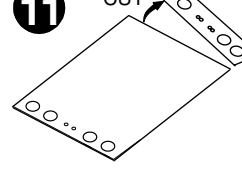

12

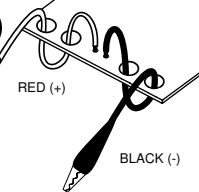

13

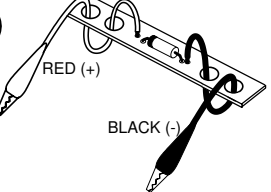

14

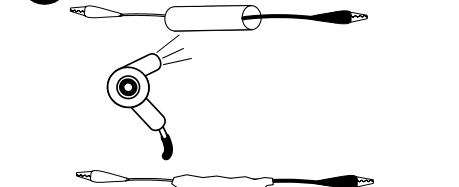

15

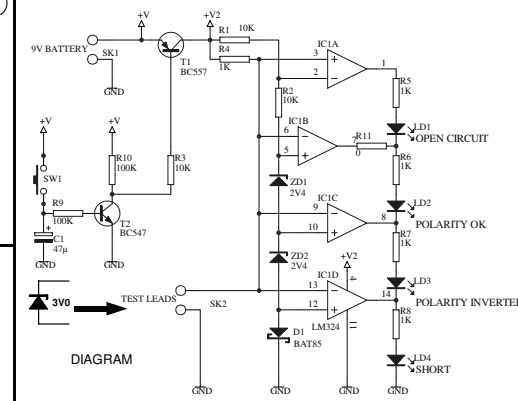
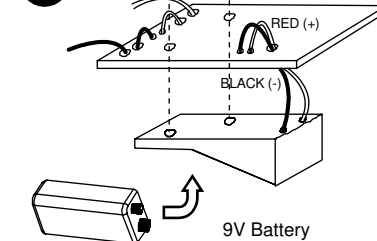

DO NOT ATTEMPT TO TEST LIVE WIRES / NIET METEN OP SPANNINGSVOEREND KABELS / N'ESSAYEZ PAS DE TESTER DES FILS SOUS TENSION / TESTEN SIE NUR SPANNUNGSGLOSE LEITER / NUNCA COMPRUEBE CABLES BAJO TENSION / NETESTUJTE KABLY POD NAPĚTÍM / TESTA ALDRIG STRÖMFORANDE KABLAR / MÁ IKKKE ANVEND ES P KABL ER, SOM ER STRÖMFORANDE / ALÅ KOSKAAN KOESTA JÄNNITTEILLISIÄ JOHTIMIA / PRECAUÇÃO: NÃO TENTAR TESTAR CIRCUITOS ATIVOS (CIRCUITOS COM CORRENTE ALTERNA) / NON TESTARE I CAVI SOTTO TENSIONE!