



KERN & Sohn GmbH

Ziegelei 1
D-72336 Balingen
E-Mail: info@kern-sohn.com

Phone: +49-[0]7433- 9933-0
Fax: +49-[0]7433-9933-149
Internet: www.kern-sohn.com

Operating manual Analytical balance

KERN TABP

Version 1.1
2021-06
GB



TABP-BA-e-2111



KERN TABP

Version 1.1 2021-06

Operating manual Analytical balance

Contents

1	Technical data	5
2	Declaration of conformity	8
3	Appliance overview	9
3.1	Components.....	9
3.2	Keyboard	11
3.2.1	Numeric entry	12
3.3	Display	13
4	Basic Information (General)	16
4.1	Proper use	16
4.2	Improper Use	16
4.3	Warranty	16
4.4	Monitoring of Test Resources.....	17
5	Basic Safety Precautions	17
5.1	Pay attention to the instructions in the Operation Manual	17
5.2	Personnel training	17
6	Transport and storage	17
6.1	Testing upon acceptance	17
6.2	Packaging / return transport	18
7	Unpacking, Setup and Commissioning	20
7.1	Installation Site, Location of Use.....	20
7.2	Unpacking and checking	20
7.2.1	Placing.....	22
7.3	Mains connection	25
7.3.1	Turning On the Power	26
7.4	Initial Commissioning	26
7.5	Connection of peripheral devices.....	27
8	Adjustment	27
8.1	Automatic adjustment via PSC function	27
8.2	Time-controlled automatic adjustment	29
8.3	Manual adjustment via key [CAL-key].....	30
8.3.1	Setting adjustment function for CAL-key.....	30
8.3.2	Adjustment with internal weight.....	30
8.3.3	Adjustment test with internal weight	31
8.3.4	Adjustment with external weight.....	31
8.3.5	Adjustment test with external weight	32
8.4	Adjustment log	33
8.5	Regular inspections	34
9	Verification	36
10	Basic Operation	38
10.1	Activate standard weighing mode	38
10.2	Simple weighing	38
10.3	Taring.....	39
10.4	Underfloor weighing.....	40
10.5	Switch off the balance.....	41
10.6	Switch-over weighing unit.....	41

10.7	Change readability (1D/10D) (not available for verified models).....	41
10.8	Display Tare / Net / Gross	42
10.9	Display decimal dot as point or comma.....	43
11	Menu	44
11.1	Navigation in the menu	44
11.1.1	Standard weighing mode	45
11.1.2	Weighing settings	46
11.1.3	System Settings	48
11.1.4	Application settings	50
11.2	Menu overview	50
11.3	Resetting the menu	51
11.4	Menu Lock.....	52
11.5	Log menu settings.....	53
11.6	Menu history	54
12	Description of individual functions	55
12.1	Zero setting and tare function.....	55
12.2	Zero tracking function.....	55
12.3	Auto Tare function.....	56
12.4	Settings for Stability and Response.....	57
12.4.1	Stability and reaction settings via „Smart Setting display“ (without invoking menu).....	57
12.5	Dosing.....	58
12.5.1	Standstill width	59
12.6	Weighing Units	60
12.7	User administration log-in function.....	60
13	Balance settings	67
13.1	Screen saver	67
13.2	Display settings in operating mode.....	67
13.3	Balance identification no.	68
13.4	Entering date and time.....	68
13.5	Date format.....	68
13.6	Brightness of display	69
13.7	Audio signal on pressing key or display of stability	69
13.8	User language.....	69
14	Application Functions	70
14.1	Parts counting	71
14.1.1	Settings	71
14.1.2	Setting the display	73
14.1.3	Part counting	73
14.1.4	Change settings	74
14.1.5	Switching between counting and weighing mode	74
14.2	Percent determination.....	75
14.2.1	Settings	75
14.2.2	Setting the display	77
14.2.3	Performing calculation of percentage	78
14.2.4	Change settings	78
14.2.5	Switching between percentage and weighing mode.....	79
14.3	Determining the density of solid matter and fluids	79
14.4	Totalization.....	80
14.5	Formulation.....	83
14.5.1	Free formulating	83
14.5.2	Define and process formulations	86
14.5.3	Change recipe.....	90
14.5.4	Sample log (KERN YKB-01N):.....	91
14.6	Preparing buffer solutions.....	92
14.7	Sample preparation	95
14.7.1	Changing saved samples.....	97
14.8	Statistics.....	98
14.9	Control weighing and target weighing.....	100
14.9.1	Target weighing.....	100

14.10	Control weighing (Pass / Fail evaluation).....	102
14.11	Minimum sample weight.....	104
15	Interfaces.....	105
15.1	Connect printer.....	105
15.2	Connect PC.....	105
15.3	Connect serial devices / connect programmable controller (SPS / PLC).....	106
15.4	Interface cable (RS232).....	106
15.5	Data transmission format.....	107
15.6	Interface commands.....	108
15.7	Communication parameters.....	112
15.7.1	Select standard setting.....	112
15.7.2	User defined settings (display example for KERN YKB-01N).....	113
15.8	Issue functions.....	115
15.8.1	Automatic data output / Auto Print function.....	115
15.8.2	Continuous data output.....	116
15.8.3	GLP Output Function.....	118
15.8.4	Defining output details.....	119
15.10	USB connection.....	120
15.10.1	Edit weighing data, adjustment logs and screenshots to USB medium.....	121
15.10.2	Data transfer by means of barcode reader.....	124
16	Servicing, maintenance, disposal.....	125
16.1	Cleaning.....	125
16.2	Servicing, maintenance.....	126
16.3	Disposal.....	127
17	Instant help.....	127
18	Ionizer (factory option).....	128
18.1	General.....	128
18.2	Basic Safety Precautions.....	128
18.3	Technical Data.....	130
18.4	Commissioning.....	130
18.5	Maintenance and cleaning.....	132

1 Technical data

KERN	ABP 100-4M	ABP 100-5DM	ABP 100-5M
Item no./ Type	TABP 100-4M-A	TABP 100-5DM-A	TABP 135-5M-A
Readability (d)	0.0001 g	0.00001 g / 0.0001 g	0,00001 g
Weighing range (max)	120 g	52 g / 120 g	135 g
Minimum load (Min)	0.01 g	0.001 g	0,001 g
Verification value (e)	0.001 g	0.001 g	0,001 g
Verification class	I	I	I
Reproducibility	0.0001 g	0.00002 g / 0.0001 g	0,00005 g
Linearity	± 0.0002 g	± 0.00005 g / 0.0002 g	± 0,0002 g
Stabilization time	2 s	2 s / 8 s	8 s
Adjustment weight	internal		
Warm-up time	8 h		
Weighing Units	mg, g, ct (unverified)		
	g, ct (verified)		
Smallest component weight for part counting	1 mg (under lab conditions*)		
	10 mg (under normal conditions**)		
Reference quantities at piece counting	1 - 100		
Weighing plate, stainless steel	ø 91mm		
Dimensions caisse (l x L x h) [mm]	212 x 367 x 345	212 x 411 x 345	213 x 433 x 344
Dimensions Glass wind screen [mm]	170 x 165 x 220 mm (weighing space)		
Net weight (kg)	7	8	7,9
Permissible ambient condition	+10° C to +30° C		
Humidity of air	20 ~ 85 % relative (not condensing)		
Power pack Input voltage	AC 100 -240 V, 300 mA 50/60Hz or AC 100 -240 V, 320 – 190 mA 50/60Hz		
Weighing scales Input voltage	DC 12 V, 1,0 A		
Degree of pollution	2		
Overvoltage category	Category II		
Metres in height	Up to 2000 m		
Place of installation	In sealed rooms only		
Interfaces	RS-232, USB (type B, PC connection), USB host (type A)		

KERN	ABP 200-4M	ABP 200-5DM	ABP 220-5M-A
Item no./ Type	TABP 200-4M-A	TABP 200-5DM-A	TABP 220-5M-A
Readability (d)	0.0001 g	0.00001 g / 0.0001 g	0,0001 g
Weighing range (max)	220 g	102 g / 220 g	220 g
Minimum load (Min)	0.01 g	0.001 g	0,02 g
Verification value (e)	0.001 g	0.001 g	0,001 g
Verification class	I	I	I
Reproducibility	0.0001 g	0.00005 g / 0.0001 g	0,00015 g
Linearity	± 0.0002 g	± 0.0001 g / 0.0002 g	± 0,0002 g
Stabilization time	2 s	2 s / 8 s	8 s
Adjustment weight	internal		
Warm-up time	8 h		
Weighing Units	mg, g, ct (unverified)		
	g, ct (verified)		
Smallest component weight for part counting	1mg (under lab conditions*)		
	10 mg (under normal conditions**)		
Reference quantities at piece counting	1 - 100		
Weighing plate, stainless steel	ø 91mm		
Dimensions caisse (l x L x h) [mm]	212 x 367 x 345	212 x 411 x 345	213 x 433 x 344
Dimensions Glass wind screen [mm]	170 x 165 x 220 mm (weighing space)		
Net weight (kg)	7	8	7,9
Permissible ambient condition	+10° C to +30° C		
Humidity of air	20 ~ 85 % relative (not condensing)		
Power pack Input voltage	AC 100 -240 V, 300 mA 50/60Hz or AC 100 -240 V, 320 – 190 mA 50/60Hz		
Weighing scales Input voltage	DC 12 V, 1,0 A		
Degree of pollution	2		
Overvoltage category	Category II		
Metres in height	Up to 2000 m		
Place of installation	In sealed rooms only		
Interfaces	RS-232, USB (type B, PC connection), USB host (type A)		

KERN	ABP 300-4M
Item no./ Type	TABP 300-4M-A
Readability (d)	0.0001 g
Weighing range (max)	320 g
Minimum load (Min)	0.01 g
Verification value (e)	0.001 g
Verification class	I
Reproducibility	0.00015 g
Linearity	± 0.0003 g
Stabilization time	2 s
Adjustment weight	internal
Warm-up time	8 h
Weighing Units	mg, g, ct (unverified) g, ct (verified)
Smallest component weight for part counting	1mg (under lab conditions*)
	10 mg (under normal conditions**)
Reference quantities at piece counting	1 - 100
Weighing plate, stainless steel	ø 91mm
Dimensions caisse (l x L x h) [mm]	212 x 367 x 345
Dimensions Glass wind screen [mm]	170 x 165 x 220 mm (weighing space)
Net weight (kg)	7
Permissible ambient condition	+10° C to +30° C
Humidity of air	20 ~ 85 % relative (not condensing)
Power pack Input voltage	AC 100 -240 V, 300 mA 50/60Hz or AC 100 -240 V, 320 – 190 mA 50/60Hz
Weighing scales Input voltage	DC 12 V, 1,0 A
Degree of pollution	2
Overvoltage category	Category II
Metres in height	Up to 2000 m
Place of installation	In sealed rooms only
Interfaces	RS-232, USB (type B, PC connection), USB host (type A)

*** Smallest component weight for part counting - under lab conditions:**

- There are ideal ambient conditions for high-resolution counting
- The parts to be counted are not scattered

**** Smallest component part for part counting – under normal conditions:**

- There are unsteady ambient conditions (draft, vibrations)
- The parts to be counted are being scattered

2 Declaration of conformity

The current EC/EU Conformity declaration can be found online in:

www.kern-sohn.com/ce

i For verified weighing scales (= weighing scales assessed for conformity) a declaration of conformity is included in the scope of delivery.

3 Appliance overview

3.1 Components

Models d = 0.0001 g

Mode. d = 0.00001 g/0.0001 g



Pos.	Description
1	Keyboard
2	Bubble level
3	Display
4	Windshield
5	Weighing pan
6	Fastening point ionizer (optional)
7	Glass wind screen
8	USB host port
9	Levelling screw

Rear view:

Models d = 0.0001 g

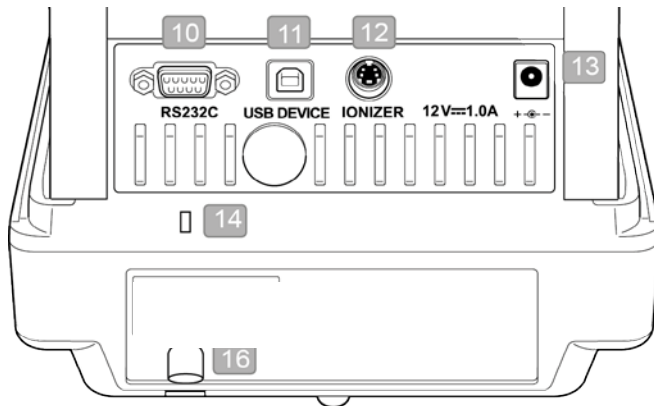

Models d = 0.00001 g/0.0001 g

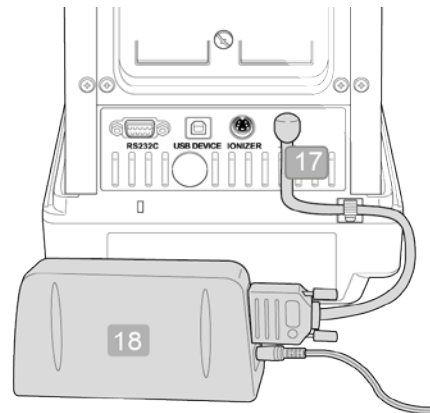







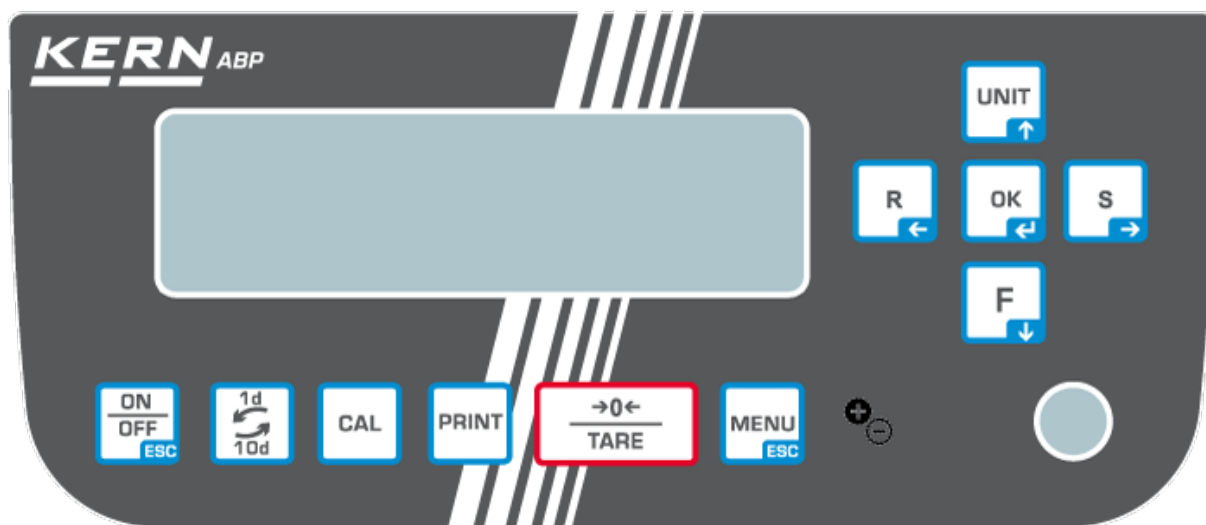

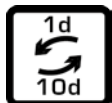

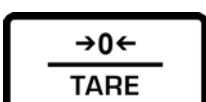
Pos.	Description
-------------	--------------------

- | | |
|----|--|
| 10 | Serial interface (RS232) |
| 11 | USB device |
| 12 | Port for ionizer |
| 13 | Connector for AC adapter |
| 14 | Fastening point for anti-theft device |
| 16 | Fastening lug for anti-theft chain or wire |
| 17 | Port for power pack |
| 18 | External electronics box |







3.2 Keyboard



Button	Description	Function		
		Short key pressing	Long key pressing	In menu
	[ON/OFF]	Switching between operating and standby mode	-	Return to weighing mode
	[1d/10d]	Readability change		
	[CAL]	Start adjustment	Call setup menu "Adjustment"	-
	[PRINT]	Data output to external device (weighing mode)	Call setup menu "Print"	
	[TARE]	Taring Zeroing	Call setup "Zero Setting / Taring"	
	[MENU]	<ul style="list-style-type: none"> • Call up menu • Call application specific settings • Call Statistics 		
	[Ionizer]	Ionizer on/off (Factory option)	Call Setup Menu Ionizer (Factory option)	
	[OK]	-	-	Confirm input

	[R]	Change reaction setting for display		Select menu item.
	Navigation button ←			
	[UNIT]	Weighing mode: Switch-over weighing unit. Counting mode: Display single weight Calculate percentage: Display reference weight	Call setup menu "Units"	Scroll forward in menu
	Navigation button ↑			
	[F]	Switch over weighing mode / application mode		Scroll backwards in menu
	Navigation button ↓			
	[S]	Change stability setting of display		Select menu item.
	Navigation button →			

3.2.1 Numeric entry

Button	Description	Function
	Navigation button ↑	Flashing digit (0 – 9) or increase character (, [blank], -, A – Z)
	Navigation button ↓	Flashing digit (0 – 9) or reduce character (, [blank], -, A – Z)
	Navigation button →	Digit selection to the right
	Navigation button ←	Digit selection to the left
	Navigation button ↵	Confirm entry
	ESC	Cancel input

3.3 Display

Apart from the display of the weighing result, all functions of the menu may be accessed from here. The display will vary, depending on the weighing scale being either in operating or setting mode.













Special keys (e.g. CAL-, TARE-, PRINT-key) provide fast and purposeful access to the individual setup menu. The navigation keys allow intuitive control.

Display example operating mode:

The display is sub-divided into four areas.



No.	Status	Description
1	Operating mode	Current application
2	User field	Display of logged-in user and current time
		Data output to external devices
		USB-storage medium is connected
		Menu Lock
3	Measuring Value	Display of weighing result in current weighing unit
		Stability display
		Net weight
		Tare weight
		Gross weight
		Hold function enabled
		Zero indicator
		Negative weighed value
		Net weight during formulating
		Tolerance marker
		Capacity display
		The non-verified value is given in brackets in verified scales.







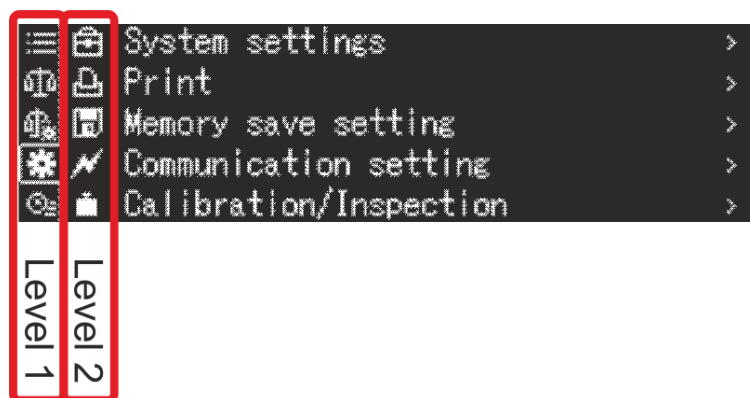



4	Status display	Current settings		
			Minimum initial weight	
			Settings for Stability and Response	
		Printer settings		
			Auto Print function active	
			Flashing during automatic Output	
			continuous output enabled	
			Flashing during continuous Output	
		Weighing settings		
			Dispensing mode	
			Zero tracking (Autom. zero point correction)	
			Statistics	
		Error reports		
			Adjustment required (PSC-function)	
	Inadequate power supply			
	Defective USB-connection			

Display example setting mode:











After pressing the MENU-key in weighing mode the display will change to setting mode.



Example of illustration: For calling system settings see chap. 11.1.3

Symbol	Description	Application icons
 Level 1	Selecting an application	 Weighing mode  Parts counting  Percent determination  Density determination <Solid matter>  Density determination <Fluids>  Totalization  Formulation  Autom. Processing a recipe  Produce a buffer solution  Produce an analysis sample

The icon for the application selected will be shown

Symbol	Description	Application icons
 Level 2	Icon of selected application	Available settings will be shown on level 1.
 Level 1	Weighing settings	 Dosing  Zero tracking
 Level 1	System Settings	 System Settings  Settings <Print>  Settings <Save data>  Settings <Communication>  Settings <Adjustment>  Settings <User>

 Level 1	History	The last 10 menu steps will be displayed.
--	---------	---

i For further information about the operation of the display, see chap. 11.1

4 Basic Information (General)

4.1 Proper use

The balance you purchased is intended to determine the weighing value of material to be weighed. It is intended to be used as a “non-automatic balance”, i.e. the material to be weighed is manually and carefully placed in the centre of the weighing pan. As soon as a stable weighing value is reached the weighing value can be read.

4.2 Improper Use

Do not use balance for dynamic add-on weighing procedures, if small amounts of goods to be weighed are removed or added. The “stability compensation“ installed in the balance may result in displaying an incorrect measuring value! (Example: Slowly draining fluids from a container on the balance.)

Do not leave permanent load on the weighing pan. This may damage the measuring system.

Impacts and overloading exceeding the stated maximum load (max) of the balance, minus a possibly existing tare load, must be strictly avoided. Balance may be damaged by this.

Never operate balance in explosive environment. The serial version is not explosion protected.

The structure of the balance may not be modified. This may lead to incorrect weighing results, safety-related faults and destruction of the balance.

The balance may only be used according to the described conditions. Other areas of use must be released by KERN in writing.

4.3 Warranty

Warranty claims shall be voided in case

- Our conditions in the operation manual are ignored
- The appliance is used outside the described uses
- The appliance is modified or opened
- Mechanical damage or damage by media, liquids, natural wear and tear
- The appliance is improperly set up or incorrectly electrically connected
- The measuring system is overloaded

4.4 Monitoring of Test Resources

In the framework of quality assurance the measuring-related properties of the balance and, if applicable, the testing weight, must be checked regularly. The responsible user must define a suitable interval as well as type and scope of this test. Information is available on KERN's home page (www.kern-sohn.com) with regard to the monitoring of balance test substances and the test weights required for this. In KERN's accredited DKD calibration laboratory test weights and balances may be calibrated (return to the national standard) fast and at moderate cost.

5 Basic Safety Precautions

5.1 Pay attention to the instructions in the Operation Manual



- ⇒ Carefully read this operation manual before setup and commissioning, even if you are already familiar with KERN balances.
- ⇒ All language versions contain a non-binding translation. The original German is binding.

5.2 Personnel training

The appliance may only be operated and maintained by trained personnel.

6 Transport and storage

6.1 Testing upon acceptance

When receiving the appliance, please check packaging immediately, and the appliance itself when unpacking for possible visible damage.

6.2 Packaging / return transport



- ⇒ Keep all parts of the original packaging for a possibly required return.
- ⇒ Only use original packaging for returning.
- ⇒ Prior to dispatch disconnect all cables and remove loose/mobile parts.

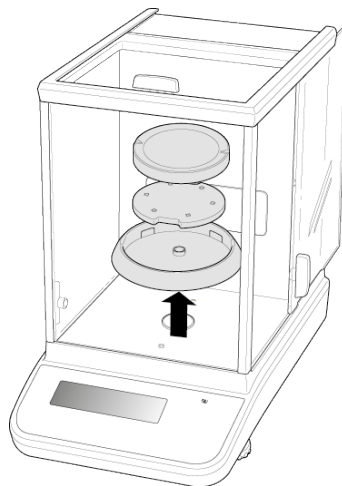
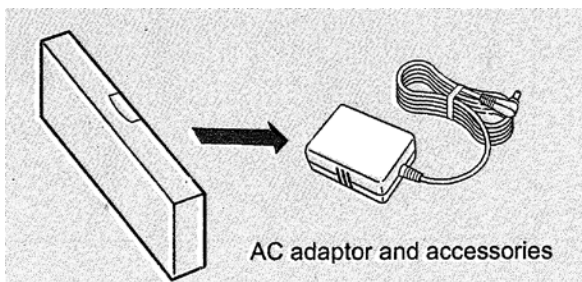
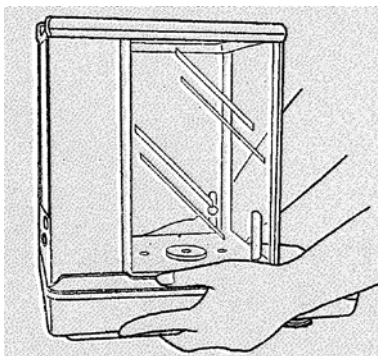

Illustration example models $d = 0.0001 \text{ g}$

- ⇒ Reattach possibly supplied transport securing devices.
- ⇒ Secure all parts such as the glass wind screen, the weighing platform, power unit etc. against shifting and damage.



- ⇒ Put network adapter and accessories in the small box



- ⇒ Lift scale with both hands

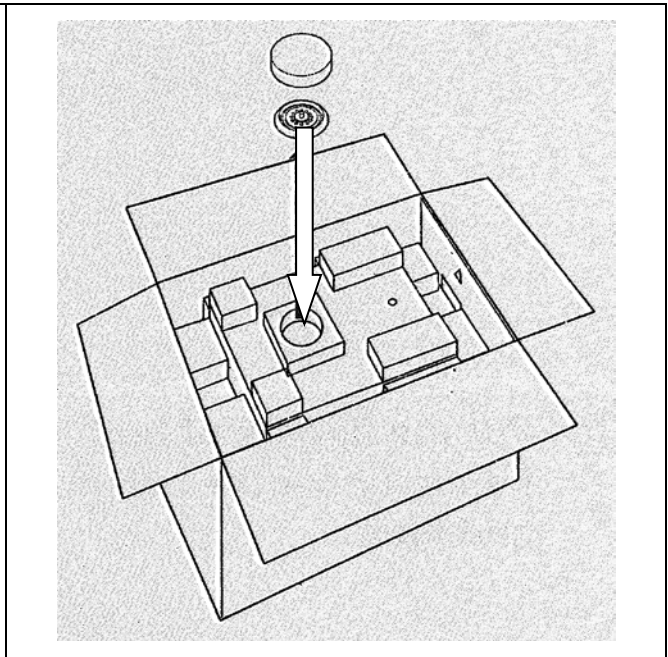
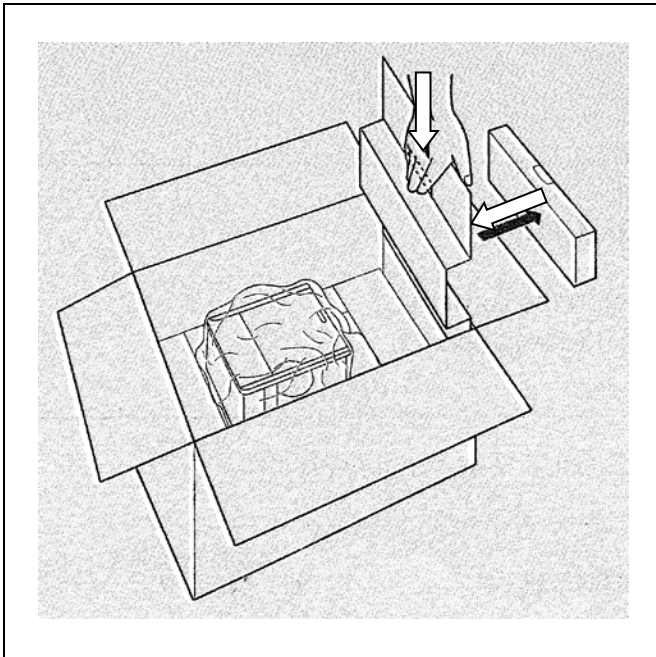
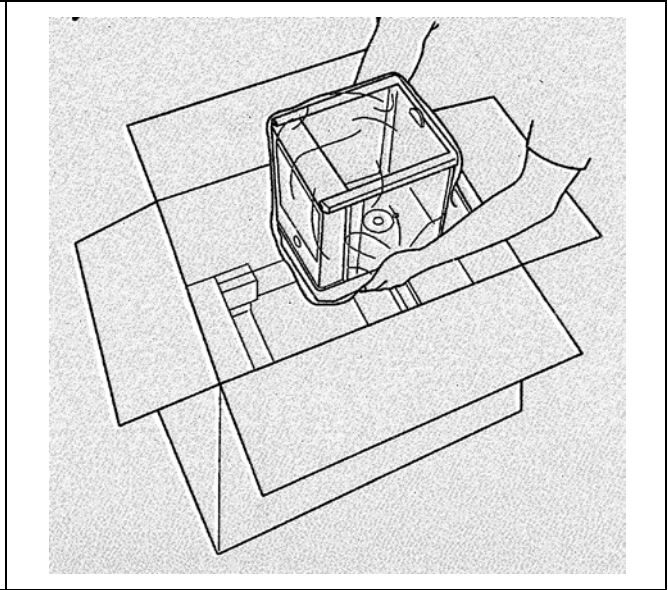
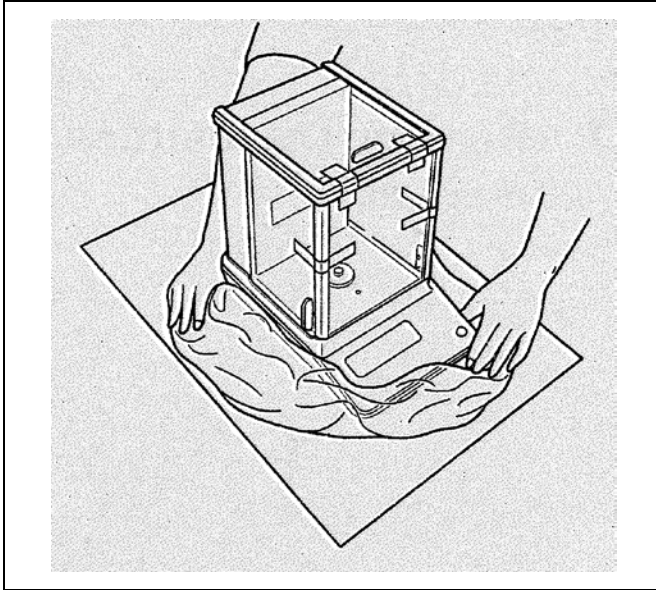

7 Unpacking, Setup and Commissioning

7.1 Installation Site, Location of Use

The balances are designed in a way that reliable weighing results are achieved in common conditions of use.

You will work accurately and fast, if you select the right location for your balance.

Therefore, observe the following for the installation site:

- Place the balance on a firm, level surface;
- Avoid extreme heat as well as temperature fluctuation caused by installing next to a radiator or in the direct sunlight;
- Protect the balance against direct draughts due to open windows and doors;
- Avoid jarring during weighing;
- Protect the balance against high humidity, vapours and dust;
- Do not expose the device to extreme dampness for longer periods of time. Non-permitted condensation (condensation of air humidity on the appliance) may occur if a cold appliance is taken to a considerably warmer environment. In this case, acclimatize the disconnected appliance for ca. 2 hours at room temperature.
- Avoid static charge of weighed items or weighing container.

If electro-magnetic fields or static charge occur, or if the power supply is unstable major deviations on the display (incorrect weighing results) are possible. In that case, the location must be changed.

7.2 Unpacking and checking

Remove device and accessories carefully from packaging, remove packaging material and place device at the planned work place. Check if that there has been no damage and that all packing items are present.

Scope of delivery / serial accessories

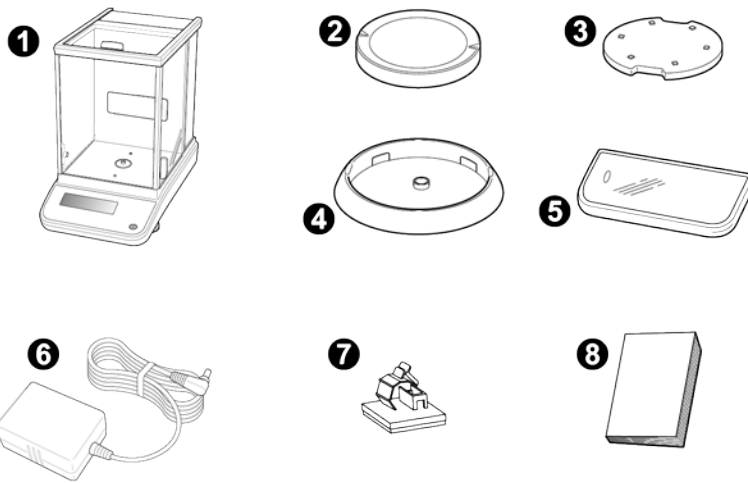

Models d = 0.00001 g/0.0001 g only:

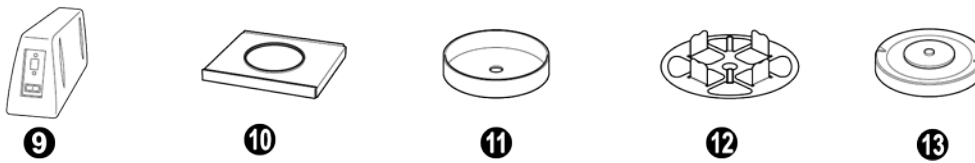

Pos.	Description
1	Balance
2	Weighing pan
3	Carrier weighing pan
4	Centring ring (Models d = 0.0001 g only)
5	Protective cover
6	Mains adapter
7	Holder for adapter cable (Models d = 0.0001 g only)
8	Operating manual
9	External electronics box
10	Guard plate
11	Windshield
12	Multi-function weighing platform
13	Support multi-function weighing platform

7.2.1 Placing

i The right place is decisive for the accuracy of the weighing results of high-resolution precision balances (see chap. 7.1).

1. Attach holder for adapter cable (Models d = 0.0001 g only)

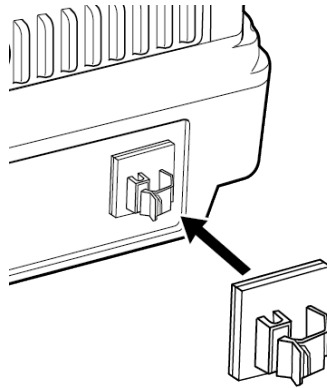

⇒ Pull off protective film and attach as shown on image.

2. Installation of weighing plate

Models d = 0.0001 g

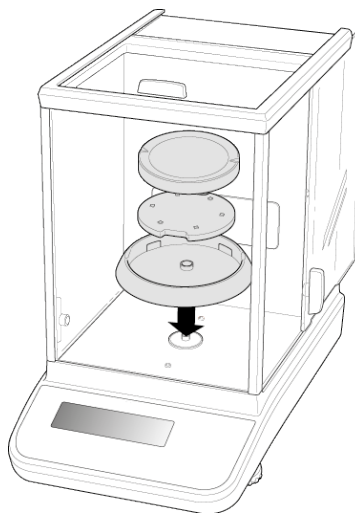

- ⇒ Attach centering ring, carrier of weighing plate and weighing plate in order.
- ⇒ Attach the safety hood

Mode. d = 0.00001 g/0.0001 g

- ⇒ Attach centering ring, carrier of weighing plate and weighing plate in order.
- ⇒ Attach the safety hood

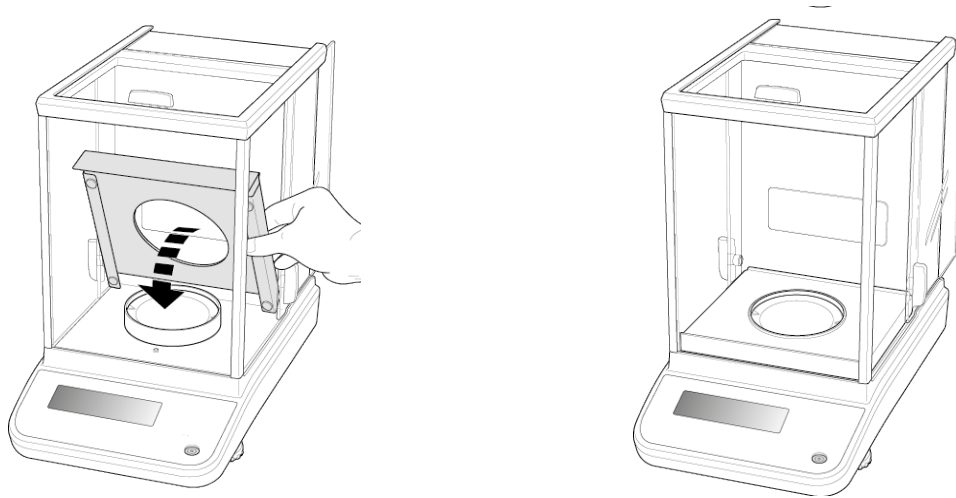

- ⇒ Place the guard plate carefully in the weighing chamber

3. Install the multi-function weighing platform (Models = 0.00001 g/0.0001 g only)

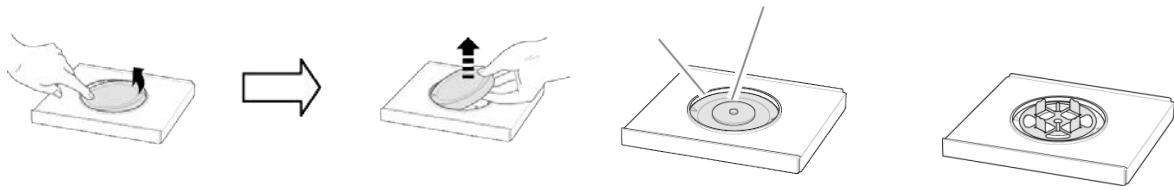

- ⇒ Disconnect scale from power supply.
- ⇒ Remove standard weighing plate as shown on image.

- ⇒ Install multi-function weighing platform together with the support. Pay due attention to centring!

Application examples:

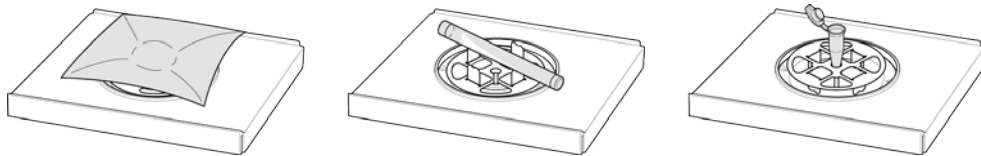

Adjustment will be required after exchanging the weighing platform, for instructions see chap. 8

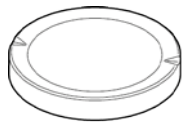

Standard weighing platform

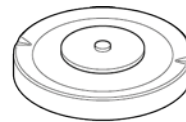

Support multi-function weighing platform

4. Levelling

⇒ Level balance with foot screws until the air bubble of the water balance is in the prescribed circle.

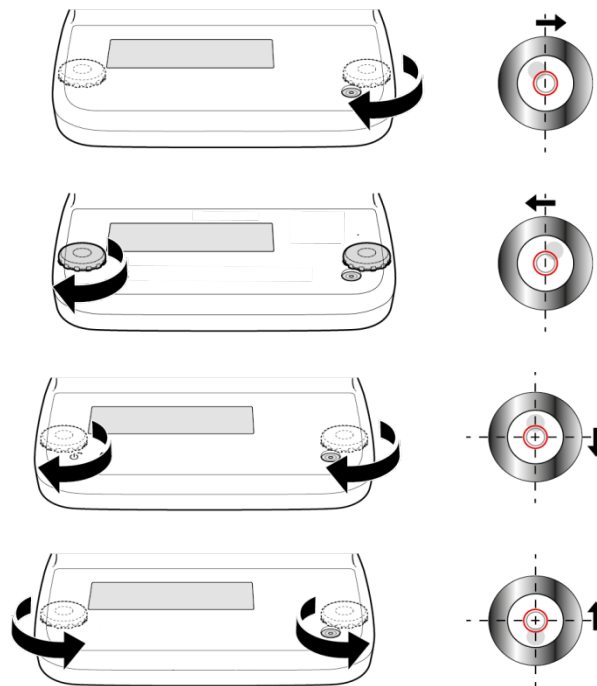

⇒ Check levelling regularly

7.3 Mains connection



Select a country-specific power plug and insert it in the mains adapter.



Check, whether the voltage acceptance on the scales is set correctly. Do not connect the scales to the power mains unless the information on the scales (sticker) matches the local mains voltage.

Only use KERN original mains adapter. Using other makes requires consent by KERN.



Important:

- Before starting your weighing balance, check the mains cable for damage.
- Ensure that the power unit does not come into contact with liquids.
- Ensure access to mains plug at all times.

7.3.1 Turning On the Power

Models d = 0.0001 g

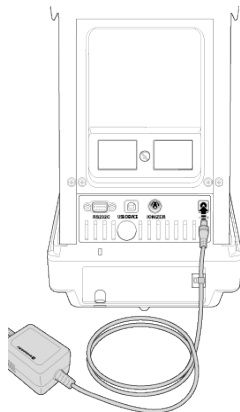

Supply power to balance via mains adapter. The display lights up and the balance carries out a selftest. Internal adjustment will be started automatically (See chap.8.3.2). The motor noise of the loading system for the internal adjustment weight will be audible.

You can cancel the adjustment by pressing the **ON/OFF** key.

The selftest is completed when „OFF“ appears on the display. From that point onwards the weighing scale will be in standby mode. The weighing balance will remain switched on as long as it is connected to the power supply.

To turn the display on/off, press the **ON/OFF** key.

When the log-in function is enabled, use the navigation keys to select the respective user and enter password, see chap. 12.7

Mode. d = 0.00001 g/0.0001 g

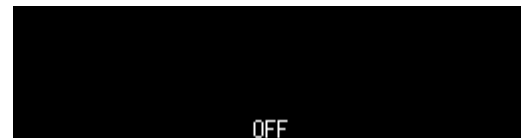
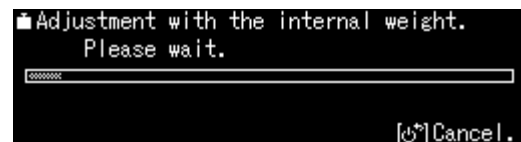
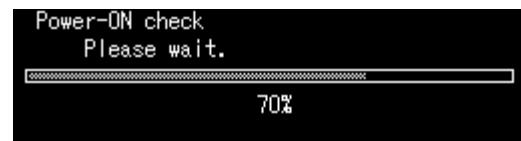
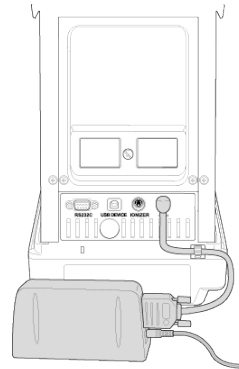

7.4 Initial Commissioning

In order to obtain exact results with the electronic balances, your balance must have reached the operating temperature (see warming up time chap.1). During this warming up time the balance must be connected to the power supply (mains, accumulator or battery). The accuracy of the balance depends on the local acceleration of gravity. Strictly observe hints in chapter Adjustment.

7.5 Connection of peripheral devices

Before connecting or disconnecting of additional devices (printer, PC) to the data interface, always disconnect the balance from the power supply.

With your balance, only use accessories and peripheral devices by KERN, as they are ideally tuned to your balance.

8 Adjustment

As the acceleration value due to gravity is not the same at every location on earth, each balance must be coordinated - in compliance with the underlying physical weighing principle - to the existing acceleration due to gravity at its place of location (only if the balance has not already been adjusted to the location in the factory). This adjustment process must be carried out for the first commissioning, after each change of location as well as in case of fluctuating environment temperature. To receive accurate measuring values it is also recommended to adjust the balance periodically in weighing operation.



- Observe stable environmental conditions. A warming up time (see chapter 1) is required for stabilization.
- Ensure that there are no objects on the weighing pan.
- Avoid vibration and air flow.
- Always carry out adjustment with the standard weighing platform in place.
- To cancel internal adjustment, press the **ON/OFF** key.
- When an optional printer is connected and the GLP function is connected, the adjustment log will be edited, see chap. 8.4

8.1 Automatic adjustment via PSC function

Force-compensated scales react sensitively to changes in temperature. The higher the sensitivity of the scale, the more pronounced the effect. The temperature controlled PSC function enables the scale to automatically correct this effect.

PSC stands for Perfect Self Calibration and facilitates fully automatic internal scale adjustment by means of an internal weight, based on time and/or temperature criteria.

Adjustment in weighing mode is carried out automatically under the following conditions:

- (1) If there is a change in ambient temperature (Δt 1°C)
- (2) When about four hours has passed since the previous calibration.
- (3) When the balance is switched from standby status to weighing mode and condition (1) or (2) has been met.

If one of the above conditions was met in weighing mode, the weight symbol  flashes for about two minutes in order to notify the pending adjustment; During operation, the display will automatically change and the motor sound of the weight loading system is heard. In order to ensure proper PSC operation, prevent vibrations and air flow.

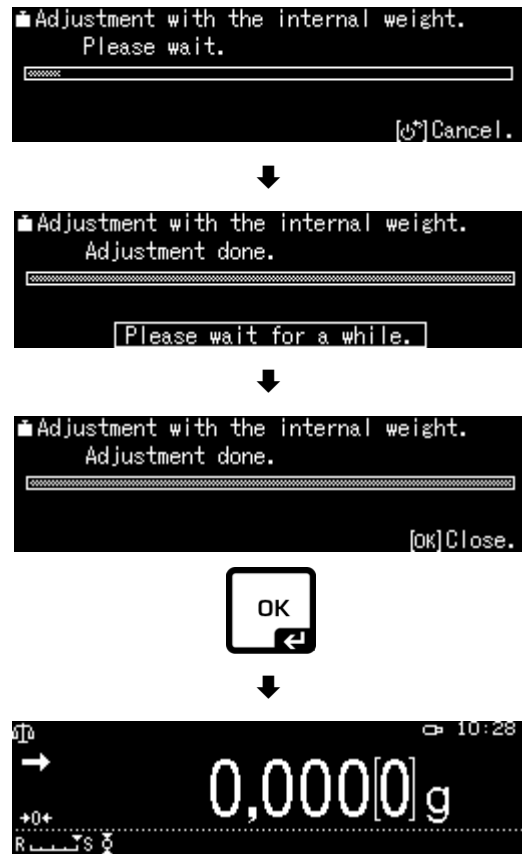

- The PSC function is always active and cannot be disabled.
- Also, no measurements can be made during automatic adjustment.
- When the weight symbol  starts flashing while the weighing platform is loaded the following message will appear



Unload weighing plate

- In order to prevent that adjustment is starting during a measuring sequence, press the ON/OFF key immediately when the following display appears. This will cancel the adjustment and you can proceed with the measuring sequence. Sometime later adjustment will be requested again by the flashing weight symbol .

8.2 Time-controlled automatic adjustment

With the help of its internal adjusting weight and integrated clock the balance can be set to carry out automatic adjustment at set times (up to three times daily). This function is a very convenient function, when adjustment reports are desired to be made for regular adjustments, or when wishing span adjustments during break times to avoid interruption of measurement work.

The weight symbol  blinks for about two minutes as notification of span calibration before it begins. Automatic adjustment can be stopped by actuating the **[ON/OFF]** key during this message.

Parameter setting:

Press and hold the **CAL**-key for approx. 3 sec. and the menu for **<CAL key>** setting will be displayed.

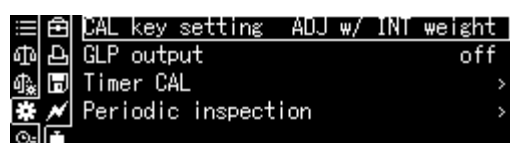

Use the navigation keys to select **<Timer CAL>** and confirm using the **OK**-key.



Select first time **<Timer 1>** and confirm using the **OK**-key.



Select setting [on] or [off] and confirm using the **OK**-key.

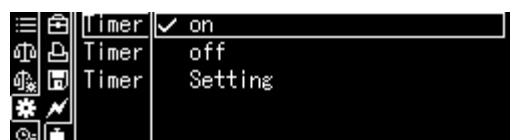

Select [Setting] to enter time.

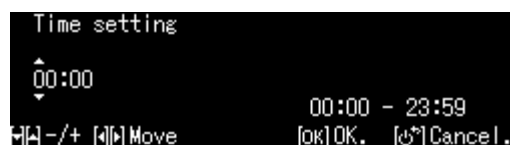

Use the navigation keys to enter time and confirm using the **OK**-key.

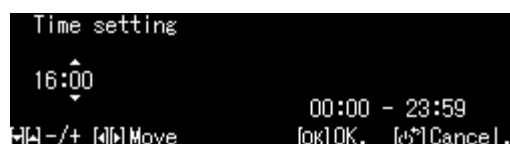

Repeat these operating steps to set the time for **<Timer 2>** / **<Timer 3>**.

8.3 Manual adjustment via key [CAL-key]

8.3.1 Setting adjustment function for CAL-key

It is possible to start the preset adjustment method without having to access the menu. The Set Adjustment Procedure may be set by simply pressing the [CAL]-key when in weighing mode.

Press and hold the **CAL**-key for approx. 3 sec until the <CAL key> setting menu appears.

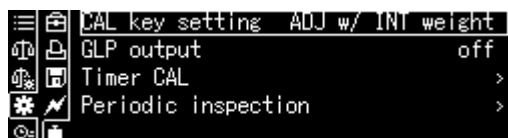

Confirm using the **OK**-key and the available settings will be displayed.

- Adjustment with internal weight, see chap. 8.3.2
- For adjustment test using internal weight, see chap. 8.3.3
- Adjustment using external weight, see chap. 8.3.4
- Adjustment test with external weight, see chap. 8.3.5

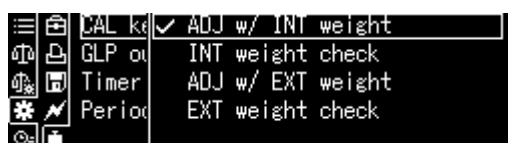

Select Settings with the help of the navigation keys and confirm using the **OK**-key.

Use the **ON/OFF** button to return into weighing mode



8.3.2 Adjustment with internal weight

Ensure that the **CAL**-key is assigned to the <Internal Weight Calibration> function, see chap. 8.3.1.

Press **CAL** key, adjustment is started.

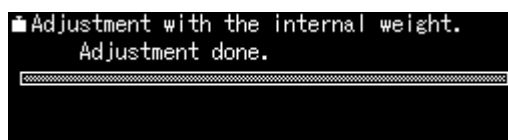
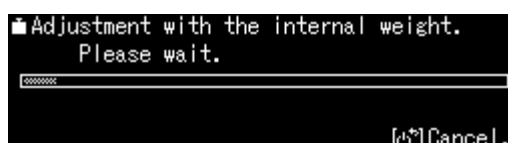

After successful adjustment the balance automatically returns to weighing mode. In case of an adjustment error (e.g. objects on the weighing plate) the display will show an error message, repeat adjustment.



8.3.3 Adjustment test with internal weight

During adjustment tests the balance automatically compares the saved value of the adjustment weight with the actual value. This is only a check, i.e. no values are changed.

Ensure that the **CAL**-key is assigned to the <Internal Weight Test> function, see chap. 8.3.1.

To start the test, press the **CAL**-key.

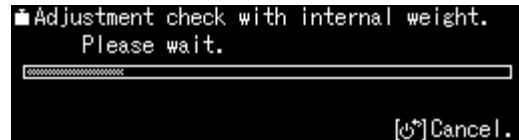

```
■ Adjustment check with internal weight.
Please wait.
-----
[C]Cancel.
```



The difference to the previous adjustment will be displayed.

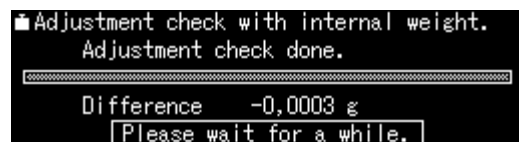

```
■ Adjustment check with internal weight.
Adjustment check done.
-----
Difference -0,0003 g
Please wait for a while.
```

8.3.4 Adjustment with external weight

Ensure that the **CAL**-key is assigned to the <External Weight Calibration> function, see chap. 8.3.1.

Press the **CAL**-key and the weight value for the adjustment weight will be flashing on the display. (To change the weight value, follow the instruction on the display*).

Put the required adjustment weight carefully in the centre of the weighing pan. Close wind screen doors completely. Wait until the request for removing the adjustment weight is displayed.

Take away adjustment weight.

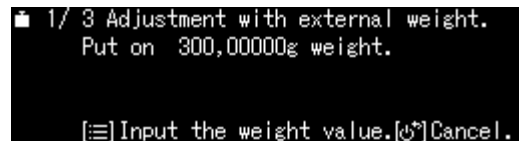

```
■ 1/ 3 Adjustment with external weight.
Put on 300,00000g weight.
-----
[≡]Input the weight value.[C]Cancel.
```

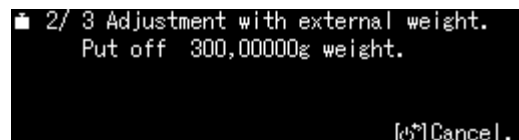

```
■ 2/ 3 Adjustment with external weight.
Put off 300,00000g weight.
-----
[C]Cancel.
```

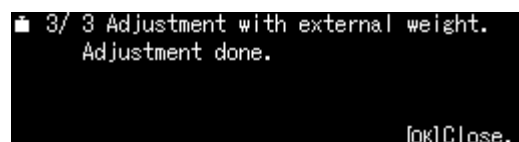

```
■ 3/ 3 Adjustment with external weight.
Adjustment done.
-----
[OK]Close.
```



*The adjustment weight to be used depends on the capacity of the scale. Carry out adjustment as near as possible to the balance's maximum weight (recommended adjustment weight see chap. 1). Weights of different nominal values may be used for adjustment but are not optimal for technical measuring. Info about test weights can be found on the Internet at: <http://www.kern-sohn.com>

8.3.5 Adjustment test with external weight

Ensure that the **CAL**-key is assigned to the <External Weight Test> function, see chap. 8.3.1.

Press the **CAL**-key and the weight value for the adjustment weight will be flashing on the display. (To change the weight value, follow the instruction on the display).

Put the required adjustment weight carefully in the centre of the weighing pan. Close wind screen doors completely. Wait until the request for removing the adjustment weight is displayed.

The difference to the previous adjustment will be displayed.

```
■ 1/ 3 Adjustment check external weight
Put on 300,00000g weight.
[≡]Adjustment [↵]Cancel.
```



```
■ 2/ 3 Adjustment check external weight
Put off 300,00000g weight.
[↵]Cancel.
```



```
■ 3/ 3 Adjustment check external weight
Adjustment check done.
Difference -0,0030 g
Please wait for a while.
```

8.4 Adjustment log

If an optional printer is connected and the GLP function enabled, this will be followed by automatic log output after every adjustment.

Printout example (KERN YKB-01N):

CAL –INTERNAL		Mode of adjustment
KERN & Sohn GmbH		Company
TYPE	ABP 300-4M	Model
SN	D319300002	Serial no.
BALID	1234	Balance identification no
DATE	2018 Aug. 17	Date
TIME	09.14.21	Time
REF	200.0000g	Used adjustment weight
BFR	200.0001g	Before adjustment
AFT	200.0000g	After adjustment
-COMPLETE		
-SIGNATURE-		Prepared by

+ For enabling / defining GLP-function see chap. 15.8.3

8.5 Regular inspections

The ABP series supports regular inspection of your scale. This function may be used to check repeatability, off-centre stress (off-centre load errors) and linearity. The instructions on the display support the implementation of individual steps.

Parameter setting:

Call up menu:

Press and hold the **CAL**-key for approx. 3 sec. and the menu for **<CAL key>** setting will be displayed.

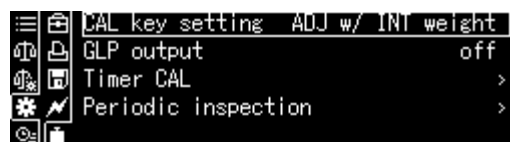

Use the navigation keys to select **<Periodic inspection>** and confirm using the **OK**-key.



1. Settings Repeatability

Select **<Repeatability insp. 1>** and confirm using the **OK**-key.



Select desired setting and confirm using the **OK**-key.

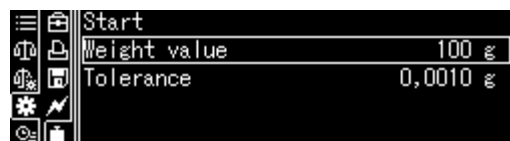

To enter the weight value for the test weight, select **<Weight value>** and confirm using the **OK**-key.



Use the navigation keys to enter the value and confirm using the **OK**-key.

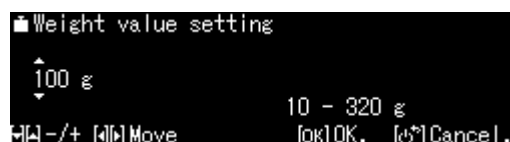

Repeat these operating steps to set all other settings for **<Tolerance>** / **<Repeat Counts>**.

Return to menu by .

2. Settings off-centre load

Repeat these operating steps for Settings as shown for "Item 1 Repeatability".

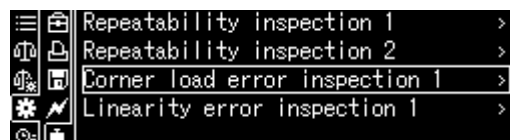

3. Settings linearization

Repeat these operating steps for Settings as shown for "Item 1 Repeatability".

Performing test sequence:

Call up menu:

Press and hold the **CAL**-key for approx. 3 sec, the **<CAL key>** setting menu will appear.

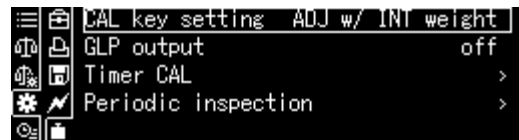

Use the navigation keys to select **<Periodic inspection>** and confirm using the **OK**-key.

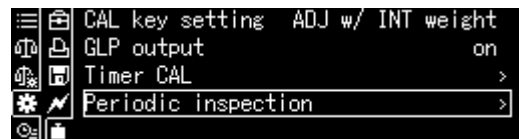

Select desired test and confirm using the **OK**-key.

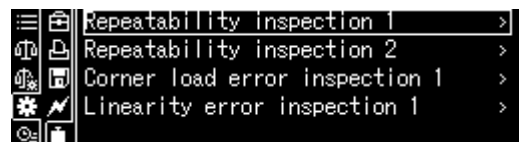

Select **<Start>** and confirm using the **OK**-key.
Follow the instructions on the display.

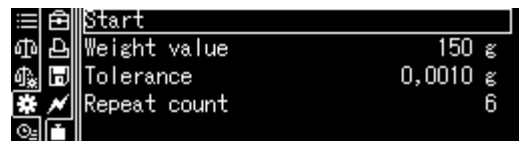

9 Verification

General introduction:

According to EU directive 2014/31/EC balances must be officially verified if they are used as follows (legally controlled area):

- a) For commercial transactions if the price of goods is determined by weighing.
- b) For the production of medicines in pharmacies as well as for analyses in the medical and pharmaceutical laboratory.
- c) For official purposes
- d) For manufacturing final packages

In cases of doubt, please contact your local trade in standard.

The scales used in the regulated area (-> verified scales) in the validity period of their verification must retain the limit errors levels permitted for used scales which are usually equal to twice the permitted limit error values for the scale reading during verification.

After the verification expires, a re-verification is required. Scale adjustment required to carry out a re-verification process, to retain the limit errors of the permitted scale reading during the verification process, is not covered by the guarantee.

Verification notes:

An EU type approval exists for balances described in their technical data as verifiable. If a balance is used where obligation to verify exists as described above, it must be verified and re-verified at regular intervals.

Re-verification of a balance is carried out according to the respective national regulations. The validity for verification of balances in Germany is e.g. 2 years.

The legal regulation of the country where the balance is used must be observed!



Verification of the balance is invalid without the seal.

The seal marks attached on verified balances point out that the balance may only be opened and serviced by trained and authorised specialist staff. If the seal mark is destroyed, verification loses its validity. Please observe all national laws and legal regulations. In Germany a re-verification will be necessary.

Position of the official seals



10 Basic Operation

10.1 Activate standard weighing mode

Status balance	Action
The balance is now in stand-by mode	Press the ON/OFF button.
Scale is in a different operating mode	Press F -key or 
Balance is in menu	Press the ON/OFF key
After numeric input	Repeatedly press the ON/OFF key.

10.2 Simple weighing



A warm-up time is required for stabilisation (see chap. 1).

- ⇒ Wait for zero display, reset to zero using **TARE**.
- ⇒ Place the goods to be weighed and close the wind screen doors
- ⇒ Wait until the stability display appears (→).
- ⇒ Read weighing result.

When an optional printer is connected, the weighing value can be edited.

Print-out example with enabled GLP function (see chap. 15.8.3):

KERN & Sohn GmbH	Company
TYPE ABP 300-4M	Model
SN D319300002	Serial no.
BALID 1234	Balance identification no. (see chap. 13.3)
DATE 2018 Aug. 17	Date
TIME 09.14.21	Time
19.999[8] g	Measuring Value
-SIGNATURE-	prepared by

Print-out example with disabled GLP function (see chap. 15.8.3):

19.999[8] g	Measuring Value
-------------	-----------------

10.3 Taring

The dead weight of any weighing container may be tared away by pressing a button, so that the following weighing procedures show the net weight of the goods to be weighed.

- ⇒ Put vessel of goods to be weighed on weighing plate and close the wind screen doors.
- ⇒ Wait until the stability display appears (→), then press **TARE**. The weight of the container is now internally saved.
- ⇒ Weigh the goods to be weighed and close the wind screen doors.
- ⇒ Wait until the stability display appears (→).
- ⇒ Read net weight.

Note:



- The balance is able to only store one taring value at a time.
- When the balance is unloaded the saved taring value is displayed with negative sign.
- To delete the stored tare value, remove load from weighing pan and press **TARE**.
- The taring process can be repeated any number of times. The limit is reached when the whole weighing range is exhausted.

10.4 Underfloor weighing

Objects unsuitable for placing on the weighing scale due to size or shape may be weighed with the help of the flush-mounted platform.

Proceed as follows:

- ⇒ Switch off the balance.
- ⇒ Open closing cover (1) at the balance bottom.
- ⇒ Place weighing balance over an opening.
- ⇒ Attach weighed good to hook and carry out weighing procedure.

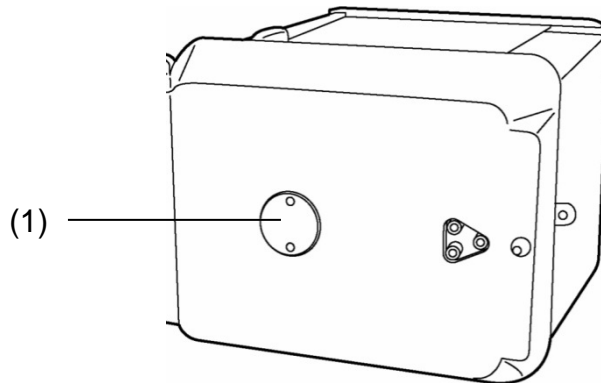

Fig.1: Underfloor weighing device



CAUTION

- **Always ensure that all suspended objects are stable enough to hold the desired goods to be weighed safely (danger of breaking).**
- **Never suspend loads that exceed the stated maximum load (max) (danger of breaking)**

Always ensure that there are no persons, animals or objects that might be damaged underneath the load.



NOTICE

After completing the underfloor weighing the opening on the bottom of the balance must always be closed (dust protection).

10.5 Switch off the balance

- ⇒ Press the **ON/OFF** button. The balance is in standby mode, that means that the balance is now in state ready-for-operation. Immediately after switching-on it is ready for operation (press any key) without warm-up time.
- ⇒ To switch-off the balance completely, separate balance from power supply.



-  When you see messages such as **[Communication]** do not disconnect scale from power supply.

10.6 Switch-over weighing unit

To return the display to the units previously enabled in the menu press the **UNIT**-key, see chap. 12.6.



-  When switching-on the balance, the unit in which the balance has been switched off, will be displayed.

10.7 Change readability (1D/10D) (not available for verified models)

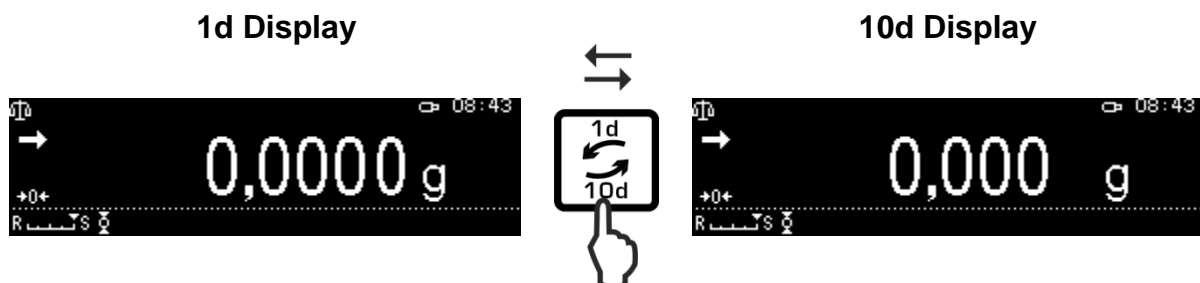

10.8 Display Tare / Net / Gross

In weighing mode press **MENU** button.

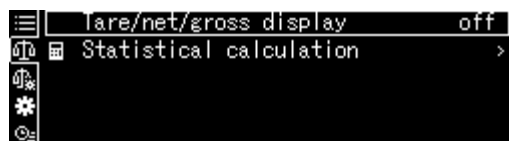

Select **<Tare/net/gross display>** and confirm using the **OK**-key.

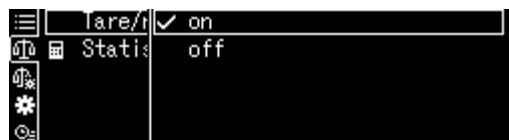

To display "Tara / Net / Gross"

Select **<on>** setting and confirm using the **OK**-key.

Setting <on>



Setting <off>



10.9 Display decimal dot as point or comma

Select System Settings and confirm using the **OK**-key.



Select **<Decimal point setting>** and confirm using the **OK**-key.



Select desired setting [Period] or [Comma] and confirm using the **OK**-key.

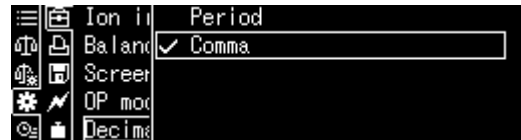



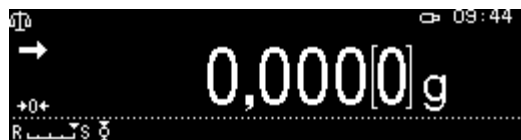
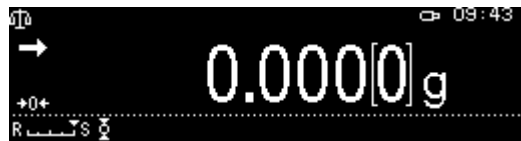





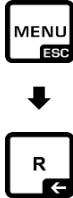



Use the **ON/OFF** button to return into weighing mode



11 Menu

11.1 Navigation in the menu

<p>Call up menu</p>	
<p>Select menu block</p>	<p>Use the navigation buttons to select the individual menu blocks one by one.</p> <p>Use the navigation key  to scroll down.</p> <p>Use the navigation key  to scroll up.</p>
<p>Select menu item</p>	<p>Confirm selected menu block by pressing . The first menu item of the selected menu block will be shown.</p> <p>Use the navigation buttons to select the individual menu items one by one.</p> <p>Use the navigation key  to scroll down.</p> <p>Use the navigation key  to scroll up.</p>
<p>Select setting</p>	<p>Confirm selected menu item with  and the current setting will be shown.</p>
<p>Change settings</p>	<p>Use the navigation keys to switch over into the available settings.</p> <p>Use the navigation key  to scroll down.</p> <p>Use the navigation key  to scroll up.</p>
<p>Confirm setting</p>	<p>Acknowledge with  or reject with </p>
<p>Return to previous menu</p>	<p>Press </p>
<p>Return to weighing mode</p>	<p>Press </p>

Display examples:

General navigation:

i All selectable functions and settings may be accessed by navigating the arrow keys [**↑**, **↓**, **←**, **→**] and confirming by pressing the **OK**-key.

The framing will indicate the current selection.

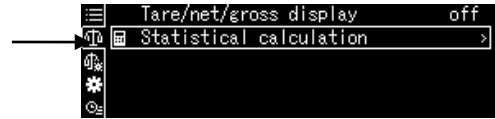

When the icon  is displayed you can press the **S**-key to access a submenu.

If a scroll bar is shown, further parameters may be displayed by using the navigation keys **↑**, **↓**.

Menu settings surrounded by square brackets are not available.

To return to the previous menu, press the **R**-key

Numerical input, see chap. 3.2.1.

11.1.1 Standard weighing mode



The list of available settings will be displayed

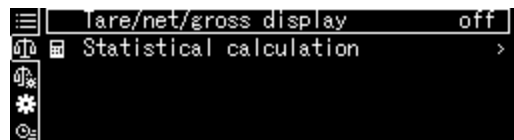

How to change settings

1. Tare/net/gross display

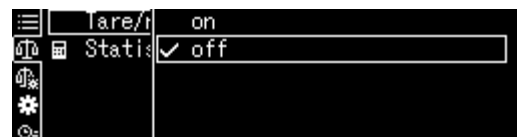
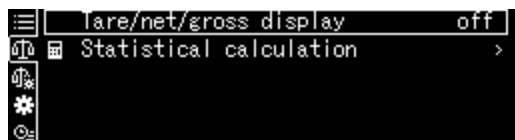

Use the navigation keys to select the desired settings **↑**, **↓** and confirm using the **OK**-key.

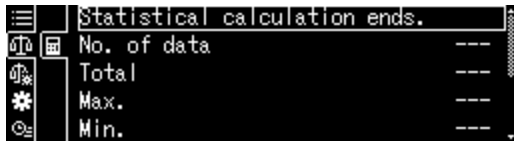
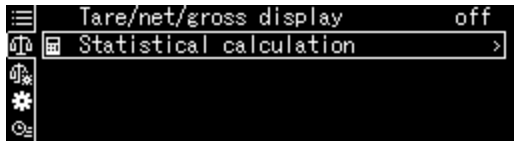
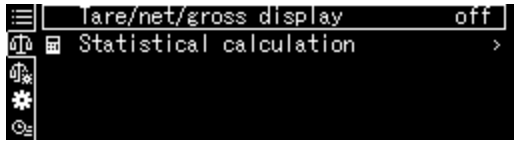

2. Statistical calculation



A submenu will be available by pressing



if the icon  is displayed.

Use the navigation keys to select the desired setting ,  and confirm using the **OK**-key.



Use  to return to the previous menu

11.1.2 Weighing settings

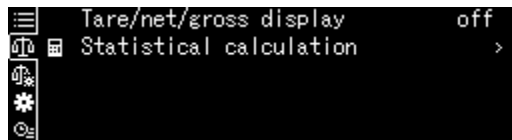
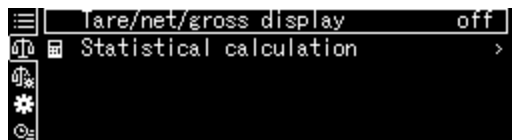

The list of available settings will be displayed.

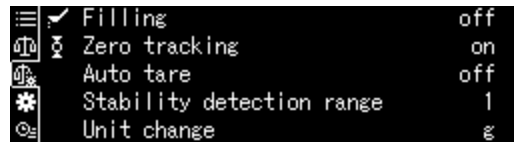

Confirm using the OK-key. The framing will indicate the current selection.

Select the desired settings using the F-key.

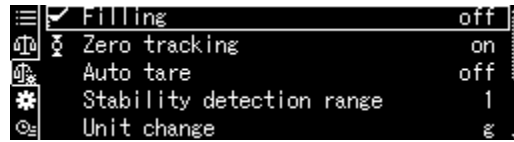

To change your selection, press the **OK**-key.

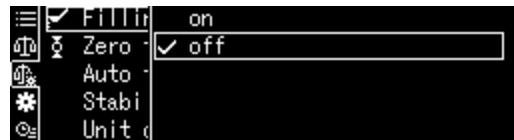

Use the navigation keys **↑**, **↓** to select the desired settings and confirm using the **OK**-key.

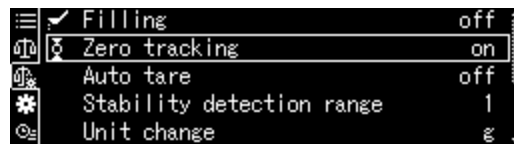

Press the F-key to select additional settings and make changes as described above.

11.1.3 System Settings

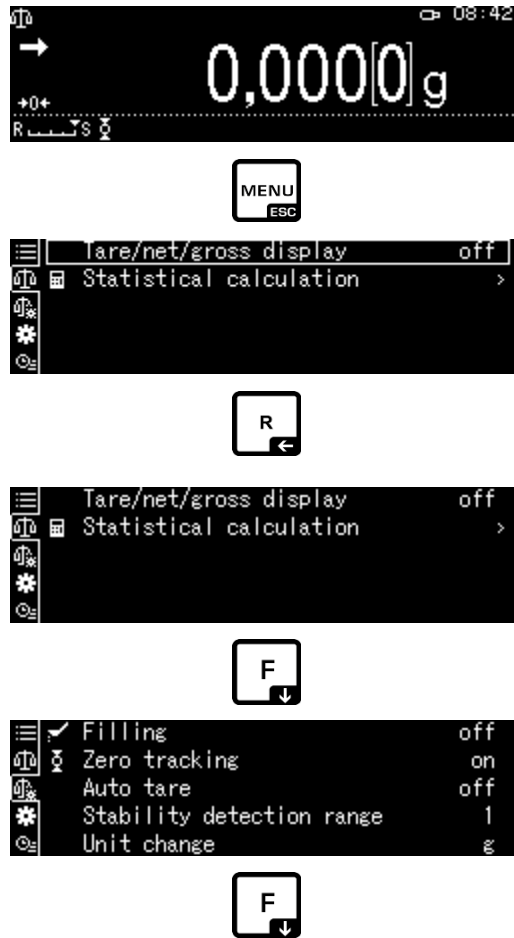

The list of available menu blocks will be displayed.

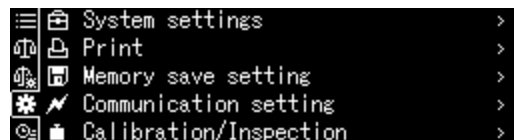

Confirm using the OK-key. The framing will indicate the current selection. Use the navigation keys \uparrow , \downarrow to select the desired menu block (such as system settings).



Confirm selection by pressing the **OK**-key.

The list of available settings will be displayed.



Use the navigation keys **↑**, **↓** to select the desired setting (such as brightness).



To change your selection, press the **OK**-key.

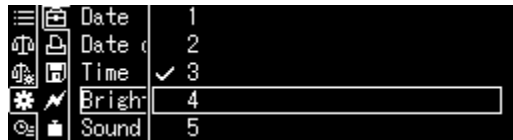

Use the navigation keys **↑**, **↓** to select the desired setting and confirm using the **OK**-key.



Press the **F**-key to select additional settings and make changes as described above.

11.1.4 Application settings

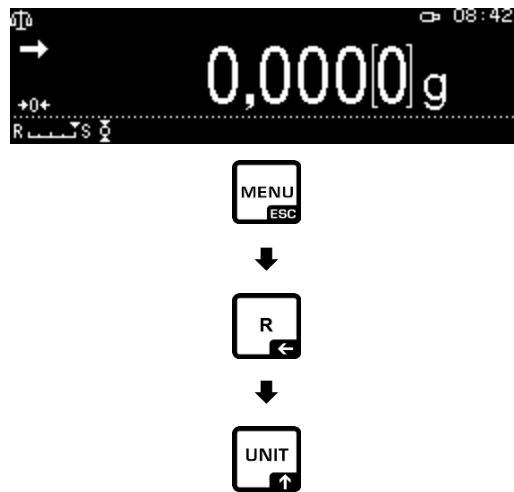

The available applications will be displayed.

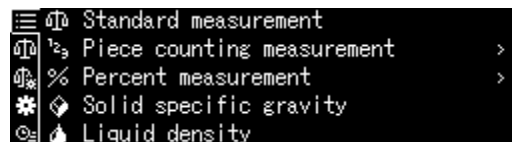

Press the **S**-key and use the navigation keys **↑**, **↓** to select the desired application, such as part counting. The framing will indicate the current selection.

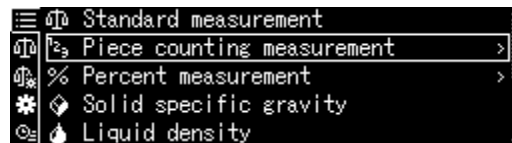

Confirm using the **OK**-key and the application specific settings will be displayed.



The application specific settings are described in the respective chapters, see chap. 14

11.2 Menu overview

i The menu overview is part of the scale's scope of delivery and supplied in the form of a separate document.

11.3 Resetting the menu

The <Menu reset> menu may be used to reset all scale settings to default settings.

- i** • Factory settings are marked by a “*” in the menu oversight.
- If user management is enabled, menu resetting may only be made by an authorised user.

1. Call System Settings

⇒ see chap. 11.1.3.



2. Enable/disable function

Confirm using the OK-key.

Use the navigation keys **↑**, **↓** to select <Menu reset> and confirm using the **OK**-key. Password prompt will be displayed. For how to enter a password, see chap. 3.2.1 "Numeric input" and confirm using the **OK**-key.



Either

Enter user-defined password

or

Enter standard password [9999] (default setting)

Confirm query by pressing the **OK**-key

The balance returns automatically into weighing mode. All user and application specific settings will be reset to default setting.

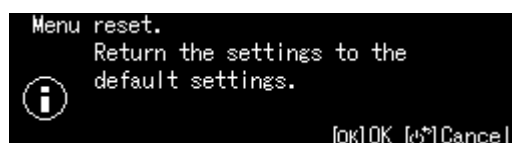

11.4 Menu Lock

The menu setting operations can be locked so that the settings cannot be inadvertently changed. This menu lock is set with the following procedure.

1. Call System Settings

⇒ see chap. 11.1.3.

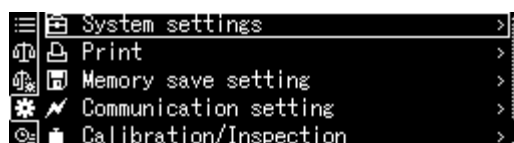

2. Enable/disable function

Confirm using the OK-key.

Use the navigation keys **↑**, **↓**, select <Menu lock> and confirm using the **OK**-key.

Password prompt will be displayed. For how to enter a password, see chap. 3.2.1 "Numeric input" and confirm using the **OK**-key.

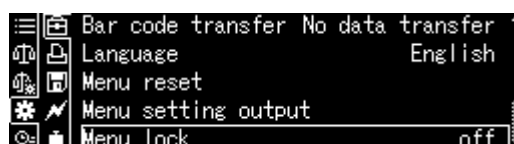

Either

Enter user-defined password

or

Enter standard password [9999] (default setting)

Confirm query by pressing the **OK**-key

Use the navigation keys **↑**, **↓** to enable (on) / disable (off) the function and confirm using the **OK**-key.

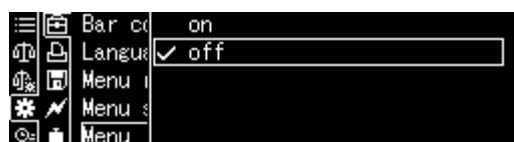

3. Return to weighing mode

Press the **ON/OFF** key

i



- The icon  will be displayed while the function is enabled.
- Weighing and adjustment can take place despite menu lock.
- Authorisation for performing this function may be allocated to any user.
- If a menu item selection is attempted in locked status, the message “**LOCKED**” appears and the menu selection is not allowed. To disable the menu block, select Settings [off].

11.5 Log menu settings

When an optional printer is connected, a list of the current menu settings can be printed out.

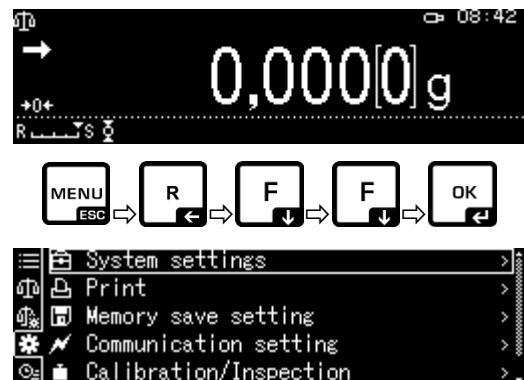

1. Call System Settings

⇒ see chap. 11.1.3.



2. Activate function

Confirm using the OK-key.

Use the navigation keys ,  to select <Menu setting output> and confirm using the **OK**-key.

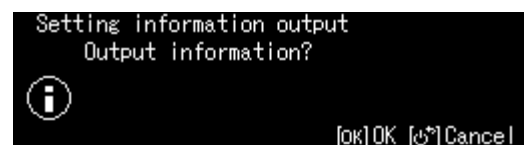
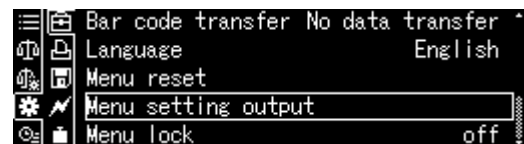

Confirm request by pressing the **OK**-key and printing will start.

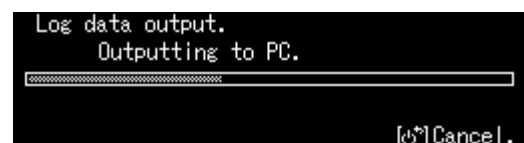

The balance returns automatically into weighing mode.

11.6 Menu history

This function is applied to display the last 10 menu steps.

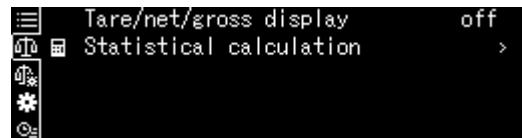

Use the navigation keys \uparrow , \downarrow to select
<  > and the last 10 menu steps will be displayed.

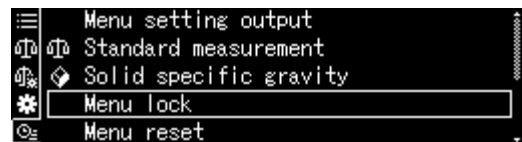

12 Description of individual functions

12.1 Zero setting and tare function

Selectable functions: Description

1. Zero tracking function

+ see chap. 12.2.

This function is used to correct automatically small weight variations which appear directly after switching-on.



In the event that small quantities are removed or added to the material to be weighed, incorrect weighing results can be displayed due to the “stability compensation”. (e.g. slow flow of liquids from a container placed on the balance, evaporating processes). When apportioning involves small variations of weight, it is advisable to switch off this function.

2. Auto tare function

+ see chap. 12.3.

After data output an automatic taring is carried out

12.2 Zero tracking function



The icon  will be displayed while the zero tracking function is enabled.

1. Call function

⇒ see chap. 11.1.2.

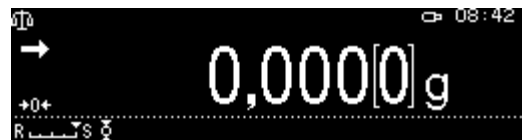

or



Press and hold the **TARE**-key for a long time

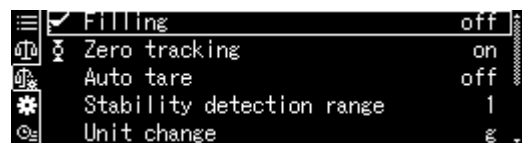

Use the navigation keys **↑**, **↓** to select <Zero tracking> and confirm using the **OK**-key.



2. Enable/disable function

Use the navigation keys **↑**, **↓** to enable (on) / disable (off) the function and confirm using the **OK**-key.

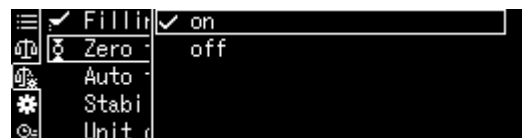

3. Return to weighing mode

Press the **ON/OFF** key

12.3 Auto Tare function

1. Call function

⇒ see chap. 11.1.2.

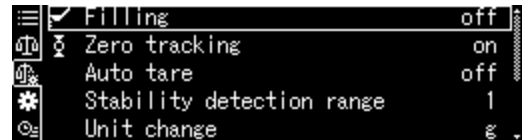

Use the navigation keys **↑**, **↓** to select <Auto tare> and confirm using the **OK**-key.

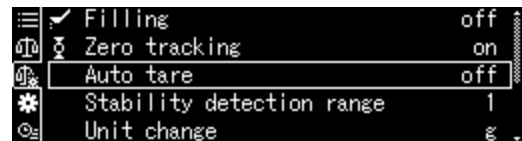

2. Enable/disable function

Use the navigation keys **↑**, **↓** to enable (on) / disable (off) the function and confirm using the **OK**-key.

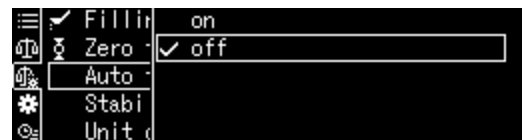

3. Return to weighing mode

Press the **ON/OFF** key

12.4 Settings for Stability and Response

Exists the possibility to tune the stability of the display and the degree of reaction of the balance to the requirements of certain applications or the environmental conditions.

Most measurements may be carried out by using default settings. In standard weighing mode, stability and reaction have the same priority. For certain applications such as e.g. dosage do use the dosing mode. In dosing mode the reaction degree has the higher priority.



Beside the selection standard / dosing mode the stability of the display and the reaction degree of the balance can additionally adapted in the menu.

Please note that in general slowing down reaction times result in higher stability of the set data handling, while speeding up reaction times have an influence on the stability deterioration.

12.4.1 Stability and reaction settings via „Smart Setting display“ (without invoking menu)

If there is a change in ambient conditions the responding qualities or the stability of the scale may be optimised – even during weighing – by simply pressing the key.



⇒ In weighing mode press  for Reaction Settings or  for Stability Settings.

Priority on reaction

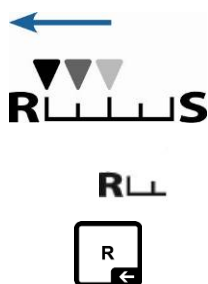

Every time the key is pressed, the priority for the reaction will be increased. The icon ▼ will be moving in the direction of <R>.

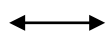

Smart setting display

Priority on stability

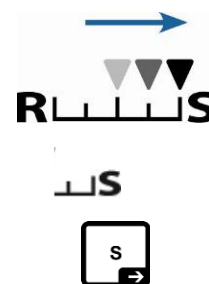

Every time the key is pressed the priority for the stability will be increased. The icon ▼ will be moving in the direction of <S>.

Operation

12.5 Dosing

Use this function if you wish to increase display speed, e.g. during apportioning. However, please note that the balance is very susceptible to ambience conditions.



The icon  will be displayed while the function is enabled.

1. Call function

⇒ see chap. 11.1.2.



Select <Filling> and confirm using the OK-key.

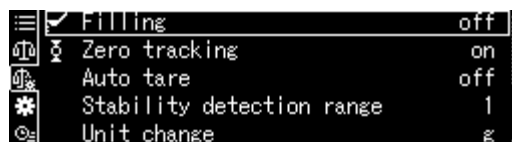

2. Enable/disable function

Use the navigation keys \uparrow , \downarrow to enable (on) / disable (off) the function and confirm using the **OK**-key.

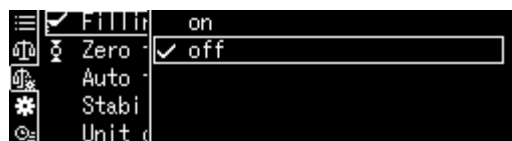

3. Return to weighing mode

Press the **ON/OFF** key

12.5.1 Standstill width

If the stability display lights up (→), the weighing result will be stable within the range indicated by the standstill width.

Set range for stability determination:

1. Call function

⇒ see chap. 11.1.2.

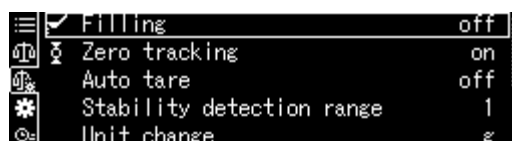

Use the navigation keys ↑, ↓ to select <Stability detection range> and confirm using the OK-key.

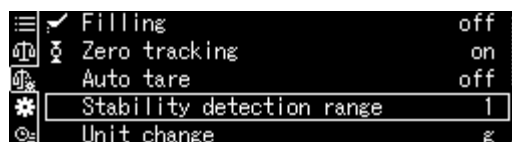

2. Set range for stability determination

Use the navigation keys ↑, ↓ to select Setting and confirm using the OK-key.

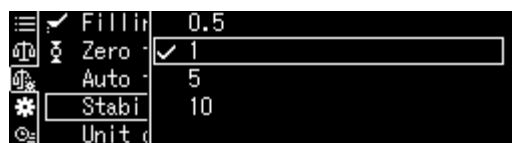

0.5d Stability display (→) very quiet environment



1000d Stability display (→) busy environment

3. Return to weighing mode

Press the ON/OFF key

12.6 Weighing Units

The **<Unit setting>** menu is used to define which weighing units you wish to apply. By pressing the **UNIT** key, the display can be switched over to the units enabled before in the menu.

Scales with type approval allow you to change to the following units:

[g] → [mg] → [ct]

1. Call function

Go to weighing mode and press and hold the **UNIT**-key for approx. 3 sec until the **<Unit setting >** menu is displayed.

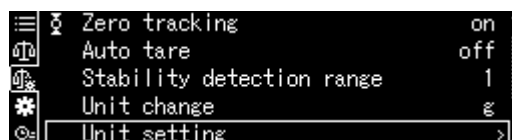

Confirm using the **OK**-key and the available units will be displayed.



Use the navigation keys to **↑**, **↓** select the unit and confirm using the **OK**-key.



2. Enable/disable units

Use the navigation keys **↑**, **↓** to enable (on) / disable (off) the function and confirm using the **OK**-key.

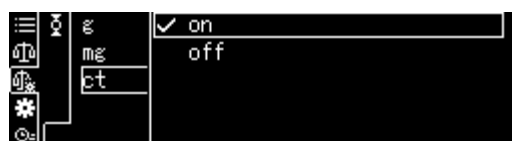

3. Return to weighing mode

Press the **ON/OFF** key

12.7 User administration log-in function

The scale has a user administration where individual access rights for administrator and user levels may be defined. The input of a user name and password is required for access.

The administrator can use all the functions and has all rights. Only the administrator is authorised to create new user profiles and to grant access rights.

A user on the other hand may not have access to all functions. He/she has limited rights that are defined in the user profile. The maximum of users is limited to 10.

a) Enable/disable function

Login function [off]	Login function [on]
All users have administrator rights and full access (default setting).	There is only one administrator and maximal 10 users.

1. Call System Settings

⇒ see chap. 11.1.3.

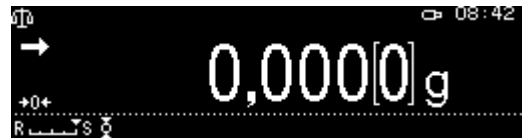

Use the navigation keys **↑**, **↓** to select <User settings> and confirm using the **OK**-key.

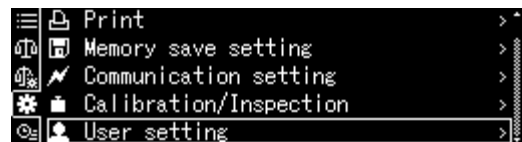

2. Enable/disable function

Use the navigation keys **↑**, **↓** to enable (on) / disable (off) the function and confirm using the **OK**-key.

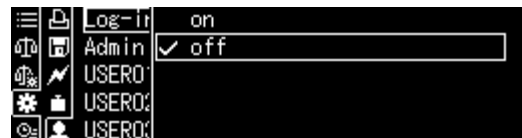
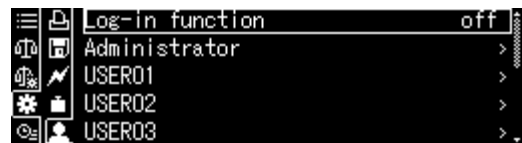

Weighing balance returns to menu.

From this point onwards you will be logged-in as administrator and authorised to change settings.

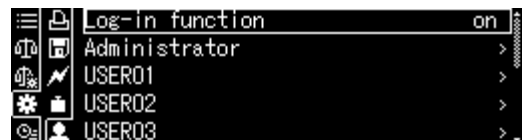

b) Creating a user profile

- i** Only the administrator may create new user profiles and grant access rights. Changes to a user profile, too, may only be made by the administrator.

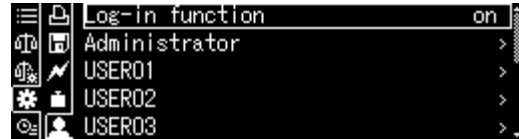

1. Select administrator or user

Use the navigation keys to **↑**, **↓** select Administrator or User <Administrator or User 01 - 10> and confirm using the **OK**-key.

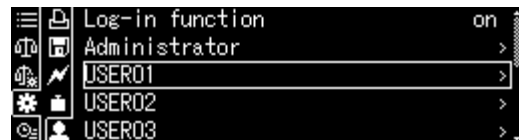

2. Define user selection to be displayed on log-in

Use the navigation keys **↑**, **↓** to select <User ID> and confirm using the **OK**-key.



Use the navigation keys **↑**, **↓** to select <valid> or <invalid> and confirm using the **OK**-key.

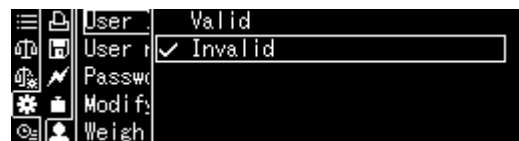

When selecting <valid> continue with input as described in the next step.

When selecting <invalid> use the **ON/OFF**-key to return to weighing mode.



3. Changing user name (ID)

Use the navigation keys to **↑**, **↓** select <User name> and confirm using the **OK**-key.



Enter desired user name (For numeric input see chap.3.2.1)

Confirm selection by pressing the **OK**-key.

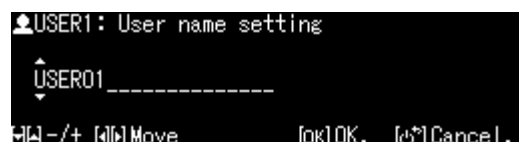

Weighing balance returns to menu.

Here you may change settings as described below.



c) Define password

Different passwords are required according to user or administrator.

Type	Administrator password	User Password
Default setting for password	9999	0000
Log-in	Administrator ID	User ID
Access rights	All functions and rights	Limited rights defined in user profile. No password will be required if default setting [0000] is used.

Use the navigation keys **↑**, **↓** to select <Password > and confirm using the **OK**-key.



Enter password

(For numeric input see chap. 3.2.1

Confirm selection by pressing the **OK**-key.

Weighing balance returns to menu.

Here you may change settings as described below.



d) Granting user rights

The administrator defines which of the following activities may be performed by the user.

Modify settings	Make settings in menu
Weighing value External output	Data output to external devices
Using USB flash drive	Access to USB storage space
Adjustment	Change adjustment settings
Test	For performing regular inspections see chap. 8.2

Use the navigation keys **↑**, **↓** to select activity such as <Modify setting>, to which access rights are to be granted or refused. Confirm selection by pressing the **OK**-key.



Use the navigation keys **↑**, **↓** to select the desired setting and confirm using the **OK**-key.

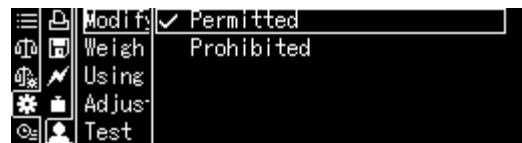

Weighing balance returns to menu.



Use the navigation keys **↑**, **↓** to select the next menu item such as <Weighing value EXToutp.> and change settings as described above.



Repeat this sequence of operations for all five menu items.

Return to weighing mode:

Press the **ON/OFF** key

e) Change user name

Use the navigation keys to **↑**, **↓** select <User name> and confirm using the **OK**-key.



Enter desired user name (For numeric entry see chap. 3.2.1)



Confirm selection by pressing the **OK**-key.

Weighing balance returns to menu.

Here you may change settings as described below.

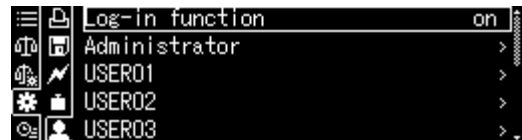

i The user name will be displayed on the top right of the display during operation and as long as the respective user profile is enabled.

f) Login

When the log-in function is enabled, the list of users will be displayed on log-in.



Use the navigation keys \uparrow , \downarrow to select User and confirm using the **OK**-key.

Password prompt will be displayed.

Enter password and confirm using the **OK**-key (For numeric entry see chap. 3.2.1).



i When a user logs in using the standard password [0000] no password query will be made.

The display will change into operating mode, the selected user will be enabled and will be shown at the top of the display.

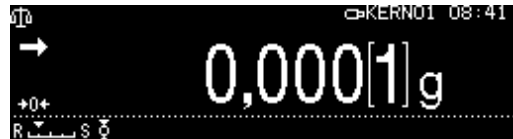

i

- Apart from administrator or user it is also possible to log-in as "Guest".
- A logged-in guest may merely perform weighing.

Sequence of operations:

Press the **ON/OFF**-key when list of users is displayed



The display will then change to operating mode, the selected user <GUEST> will be enabled and shown on the top of the display.



13 Balance settings

13.1 Screen saver

While this function is enabled the scale will automatically change to standby mode after a defined time without a change in load or conditions. You can turn off the function [off] or define a time after which the scale is to change into standby mode. To restart press the **ON/OFF**-key.

Call System settings (see chap. 11.1.3).

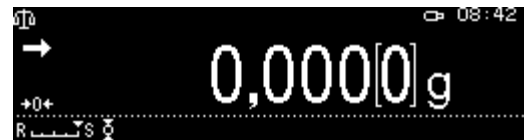

Use the navigation keys **↑**, **↓** to select <Screen saver> and confirm using the **OK**-key.

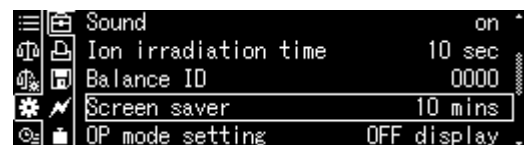

Use the navigation keys **↑**, **↓** to select switch off time and confirm using the **OK**-key.

Options: off, 5, 10, 15, 20, 30 min.

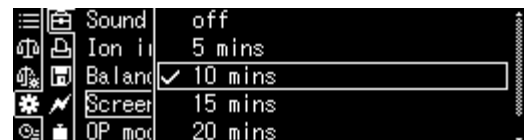

Use the **ON/OFF** button to return into weighing mode

13.2 Display settings in operating mode

For calling system settings see chap. 11.1.3.

Use the navigation keys **↑**, **↓** to select <OP mode setting> and confirm using the **OK**-key.

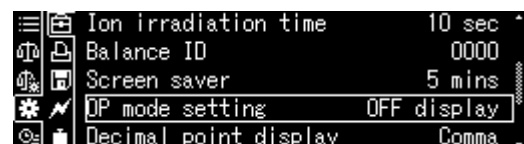

Use the navigation keys **↑**, **↓** to select the desired setting and confirm using the **OK**-key.

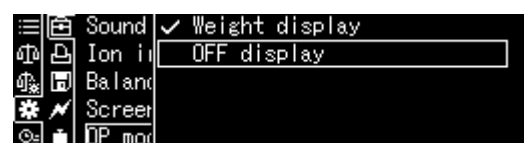

Use the **ON/OFF** button to return into weighing mode

13.3 Balance identification no.

This setting is for the balance ID number that is output along with the adjustment report.

For calling system settings see chap. 11.1.3.

Use the navigation keys **↑**, **↓** to select <Balance ID> and confirm using the **OK**-key.

Use the navigation keys **↑**, **↓** to enter name (max. 16 characters) and confirm using the **OK**-key.

Numerical input, see chap. 3.2.1.

Use the **ON/OFF** button to return into weighing mode

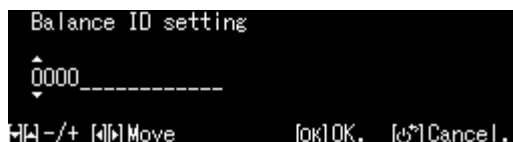
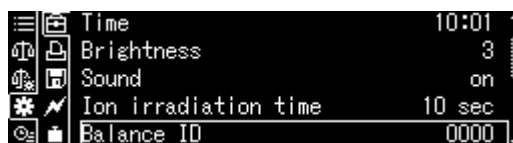

13.4 Entering date and time

For calling system settings see chap. 11.1.3.

Use the navigation keys **↑**, **↓** to select <Date> or <Time> and confirm using the **OK**-key.

Use the navigation keys **↑**, **↓** to enter date or time and confirm using the **OK**-key.

Numerical input, see chap. 3.2.1.

Use the **ON/OFF** button to return into weighing mode



13.5 Date format

For calling system settings see chap. 11.1.3.

Use the navigation keys **↑**, **↓** to select <Date output style> and confirm using the **OK**-key.

Use the navigation keys **↑**, **↓** to set the display format and confirm using the **OK**-key.

Use the **ON/OFF** button to return into weighing mode

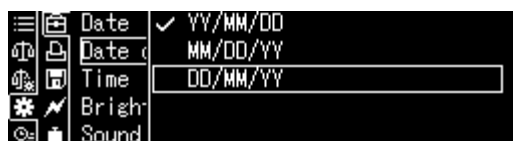

13.6 Brightness of display

For calling system settings see chap. 11.1.3.

Use the navigation keys **↑**, **↓** to select <Brightness> and confirm using the **OK**-key.

Use the navigation keys **↑**, **↓** to set brightness and confirm using the **OK**-key

Use the **ON/OFF** button to return into weighing mode

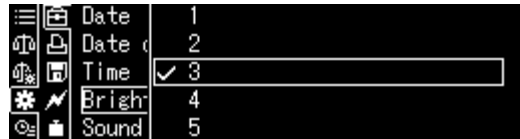

13.7 Audio signal on pressing key or display of stability

For calling system settings see chap. 11.1.3.

Use the navigation keys **↑**, **↓** to select <Sound> and confirm using the **OK**-key.

Use the navigation keys **↑**, **↓** to select setting [on] or [off] and confirm using the **OK**-key

Use the **ON/OFF** button to return into weighing mode

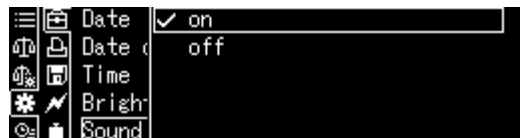

13.8 User language

For calling system settings see chap. 11.1.3.

Use the navigation keys **↑**, **↓** to select <Language> and confirm using the **OK**-key.





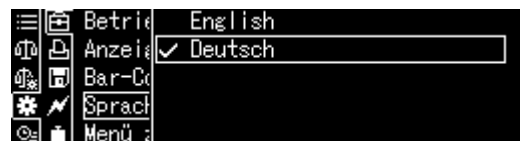



Use the navigation keys **↑**, **↓** to select language and confirm using the **OK**-key

Use the **ON/OFF** button to return into weighing mode



14 Application Functions

Overview of available applications:

Symbol	Function	Combinable functions		
		Statistics	Check weighing	Minimum initial weight
	Parts counting	✓	✓	✓
	Percent determination	✓	✓	✓
	Density determination <Solid matter>	✓	✓	✓
	Density determination <Fluids>	✓	✓	✓
	Totalization	-	-	✓
	Free formulating	-	-	✓
	Autom. processing a recipe	-	-	✓
	Produce a buffer solution	-	-	✓
	Produce an analysis sample	-	-	✓



- The balance starts in the mode, in which it has been switched off.
- To switch between application and weighing mode press the **F**-key (not available for statistics, check weighing, minimal weight)

14.1 Parts counting

With parts counting you can either count parts into a container or remove parts from a container. To count a greater number of parts the average weight per part has to be determined with a small quantity (reference quantity). The larger the reference quantity, the higher the counting exactness. High reference must be selected for small parts or parts with considerably different sizes.

14.1.1 Settings

- + **Enable function and calculate single weight by weighing a known reference quantity**

Selecting an application (see chap. 11.1.4)

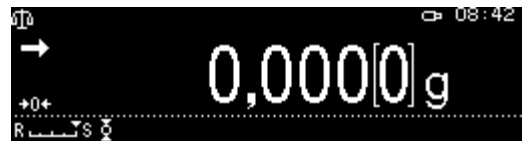

The available applications will be displayed.

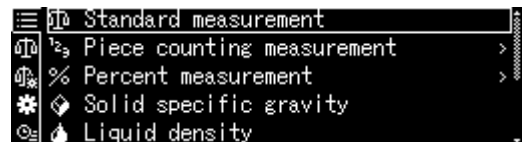

Use the navigation keys **↑**, **↓** to select <Piece counting measurement>. The framing will indicate the current selection. Confirm using the **OK**-key and the application specific settings will be displayed.

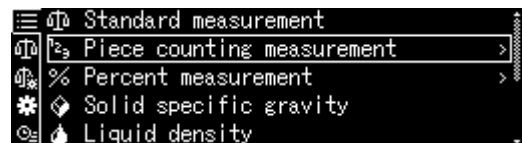

1. Storage location no. / name for initial input

Use the navigation keys **↑**, **↓** to select storage location and confirm using the **OK**-key.



During the **initial entry** there will be a display where you can enter a storage name. Use the navigation keys **↑**, **↓** to select storage location and confirm using the **OK**-key.

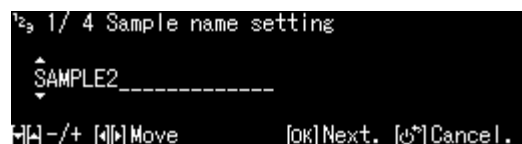

If required, change name and confirm using the **OK**-key.

i To **overwrite** a stored single weight continue by referring to chap. 14.1.4

2. Set reference

Enter reference quantity and confirm using the **OK**-key.

```
2/ 4 Setting reference PCS
005 PCS
1 - 100 PCS
[-]/+ [M] Move [OK] Next. [*] Cancel.
```

Load the number of parts corresponding to the selected reference quantity. Wait until stability display has settled, then confirm using the **OK**-key.

```
3/ 4 Unit weight measurement
→ 20,000[1]g
R S g [OK] Meas. [*] Cancel.
```

The scale will calculate the average single weight and display the result. Confirm using the **OK**-key

```
4/ 4 Unit weight registered
Name TEST
Unit Weight. 4,0000200 g
Reference PCS 5 PCS
[OK] Close.
```

+ Enter single weight as numeric value

- ⇒ In counting mode, press **MENU**-key.
- ⇒ Use the navigation keys **↑**, **↓** to select <Unit weight> and confirm using the **OK**-key.
- ⇒ Enter known single weight and confirm using the **OK**-key.

```
Sample name TEST
Reference PCS 25
Reference weight 99,9968 g
Unit weight 3,9998720 g
Display with load weight off
```

```
Unit weight setting
003,9998720 g
0,0001000 - 320 g
[-]/+ [M] Move [OK] OK. [*] Cancel.
```

14.1.2 Setting the display

- ⇒ In counting mode, press **MENU**-key.
- ⇒ Use the navigation keys **↑**, **↓** to select <Display with load weight> and confirm using the **OK**-key.
- ⇒ Select <on> or <off> and confirm using the **OK**-key.

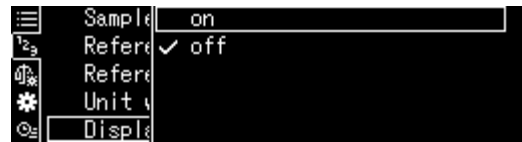
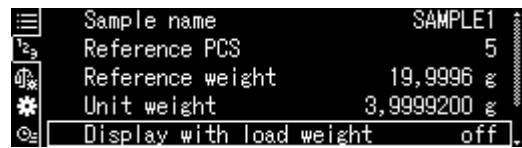

Setting <off>



Setting <on>

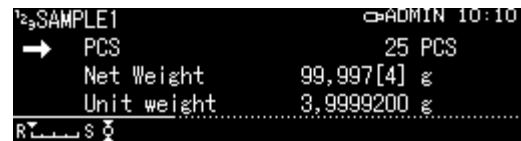

14.1.3 Part counting

- ⇒ In counting mode, select stored single weight and confirm using the **OK**-key (chap. 14.1.1).
- ⇒ Put empty container on the scale and tare.
- ⇒ Fill weighing goods into the container and read the piece quantity.



14.1.4 Change settings

- ⇒ In counting mode, press **Menu**-key.
- ⇒ Select <Changing registration> and confirm using the **OK**-key.
The following changes may be made:

Product name:

Change name and confirm using the **OK**-key.

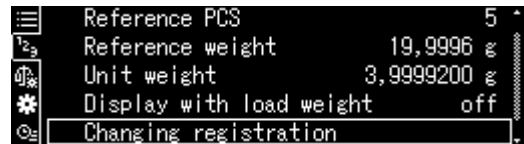

Reference quantity:

Change reference single weight and confirm using the **OK**-key.



Weight according to selected reference quantity:

Load weight and confirm using the **OK**-key.

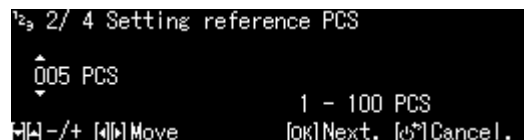

- ⇒ The changes made will be displayed.

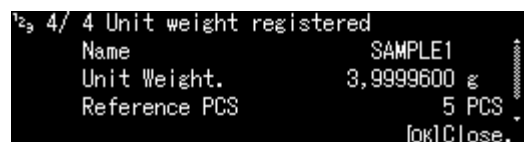

- ⇒ To return to counting mode, press the **ON/OFF**-key

14.1.5 Switching between counting and weighing mode



14.2 Percent determination

Percent weighing allows to display weight in percent, in relation to a reference weight.

The balance offers two possibilities:

1. Loaded reference weight = 100 %
2. Loaded reference weight = user defined

14.2.1 Settings

+ Activate function

Selecting an application (see chap. 11.1.4)



The available applications will be displayed.

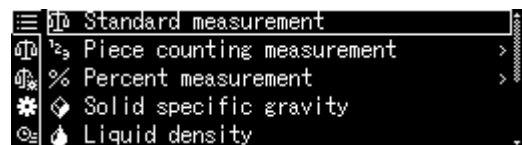

Use the navigation keys \uparrow , \downarrow to select calculation of percentage. The framing will indicate the current selection.

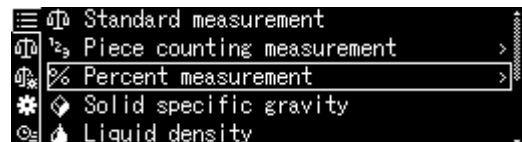

Confirm using the **OK**-key and the application specific settings will be displayed.

100PER1 -3:

Loaded reference weight = 100 %

ANYPER1, 2:

Loaded reference weight = user defined [%]



During the **initial entry** there will be a display where you can enter a storage name. Use the navigation keys **↑**, **↓** to select storage location and confirm using the **OK**-key.

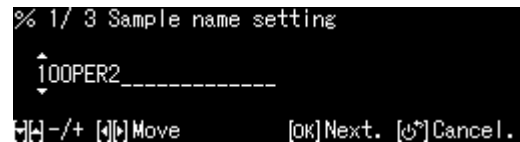

If required, change name and confirm using the **OK**-key.

To **overwrite** a stored reference continue by referring to chap. 14.2.4

Further steps:

- ⇒ **Loaded reference weight = 100 %**
- or**
- ⇒ **Loaded reference weight = user defined [%]**

+ Loaded reference weight = 100 %

⇒ Select 100PER1, 2 or 3 (or own description) and confirm using the **OK**-key



⇒ If required, place empty container on scale and tare.



⇒ Load reference weight corresponding to 100 %
(Minimum weight: Readability d x 100).
Wait until stability display (→) has settled, then confirm using the **OK**-key.

⇒ The reference will be imported and displayed.

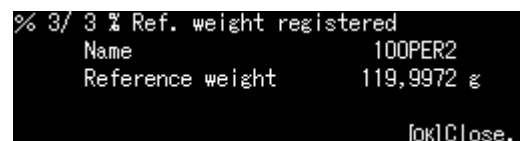

⇒ Confirm using the **OK**-key

⇒ From now on the weight of the sample will be shown in percent based on the reference weight



+ Loaded reference weight = user defined [%]

- ⇒ Select ANYPER1 or 2 (or own description) and confirm using the **OK**-key
- ⇒ Use the navigation keys to enter a percentage value of your choice and confirm using the **OK**-key.
- ⇒ If required, place empty container on scale and tare.
- ⇒ Load reference weight corresponding to the entered percentage value and confirm using the **OK**-key.
- ⇒ The reference will be imported and displayed.
- ⇒ Confirm using the **OK**-key
- ⇒ From now on the weight of the sample will be shown in percent based on the reference weight

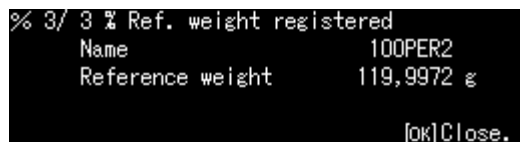
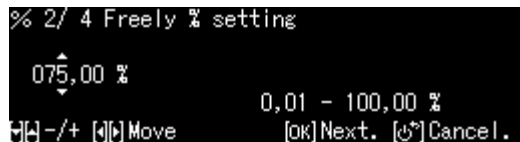

14.2.2 Setting the display

- ⇒ In percentage mode, press the **MENU**-key.
- ⇒ Use the navigation keys **↑**, **↓** to select <Display with load weight> and confirm using the **OK**-key.
- ⇒ Select <on> or <off> and confirm using the **OK**-key.

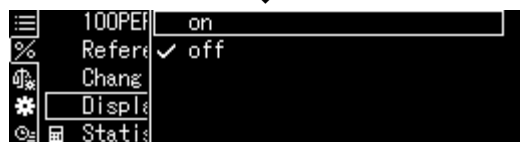
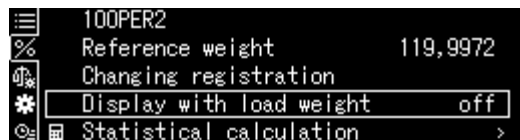

Setting <off>



Setting <on>

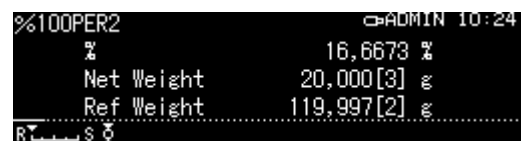

14.2.3 Performing calculation of percentage

⇒ In percentage mode, select stored reference and confirm using the **OK**-key (chap. 14.2.1).



⇒ Put empty container on the scale and tare.

⇒ Fill weighed good into container. The weight of the weighed good will be displayed in percent.

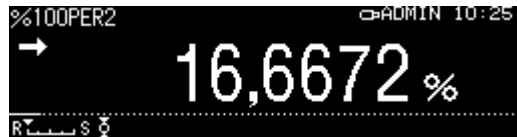

14.2.4 Change settings

⇒ In percentage mode, press the **Menu**-key.

⇒ Select <Changing registration> and confirm using the **OK**-key.

The following changes may be made:

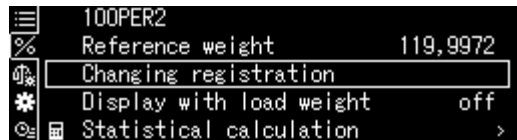

Product name:

Change name and confirm using the **OK**-key.

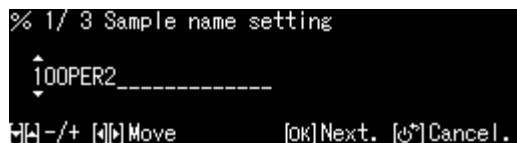

Reference weight:

Load weight and confirm using the **OK**-key.



⇒ The changes made will be displayed.

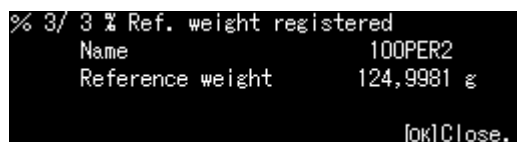

⇒ To return to percentage mode, press the **ON/OFF**-key.



14.2.5 Switching between percentage and weighing mode



14.3 Determining the density of solid matter and fluids

For density determination we recommend working with the optionally available density determination set.

The set contains all the accessories and aids required for easy and precise density determination.

For instructions please see the operating instructions enclosed with the density determination set.

14.4 Totalization

This function is used to automatically add any number of single weighings to a total sum.

When the standstill control (→) is complete the weighing value is automatically issued to an optional printer or a PC. The displayed value is added into the total adding memory. Afterwards automatic taring will take place. This is repeated newly every subsequent time a new sample is placed on the balance. When the last single weighing process is finished, press the PRINT key to receive the total sum ("TOTAL=").

- ⇒ For selecting an application see chap. 11.1.4



The available application will be displayed.

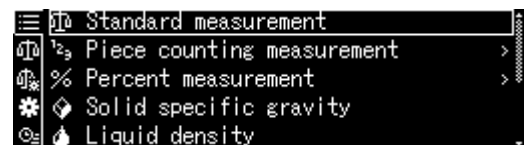

- ⇒ Use the navigation keys ↑, ↓ to select <Add-on>. The framing will indicate the current selection.

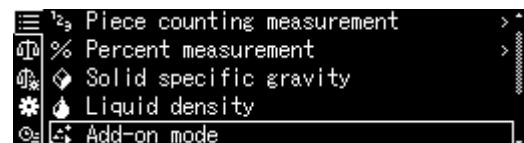

- ⇒ If required, place the empty container on the scale and tare.

- ⇒ To start the add-up sequence, press the **OK**-key.

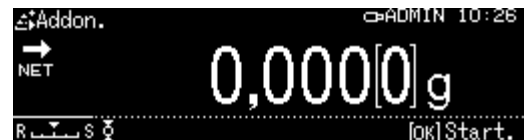

If connected to an optional printer, a header will be issued.

- ⇒ Place first good to be weighed on balance. When the standstill control (→) is complete the weighing value is automatically issued to the optional printer. The displayed value is added into the total adding memory. Afterwards automatic taring will take place.

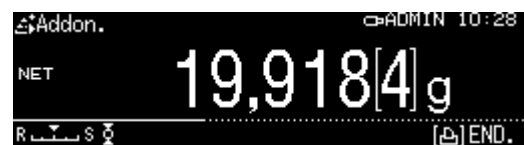

- ⇒ Repeat this sequence for each additional component.
- ⇒ To complete the sequence and to display the total, press the **PRINT**-key.

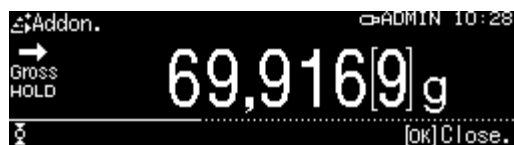

- ⇒ To start another add-up sequence, press the **OK**-key.



Data output:

- ⇒ In totalizing mode press **MENU** button.
- ⇒ Use the navigation keys **↑**, **↓** to select <Print> and confirm using the **OK**-key.



1. Output item number

- ⇒ Use the navigation keys **↑**, **↓** to select <Element No. output> and confirm using the **OK**-key.
- ⇒ Select <on> or <off> and confirm using the **OK**-key.

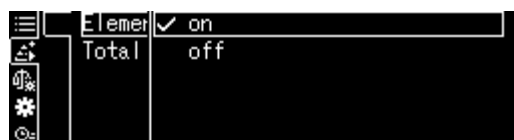
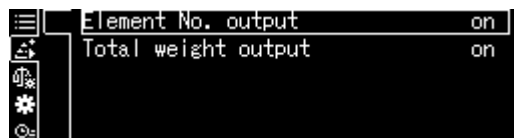

**Sample log
Element No. output <on>**

**Sample log
Element No. output <off>**

ADDON MODE		ADDON MODE	
N001 =	1.004[1] g	1.004[1] g	
N002 =	0.999[2] g	0.999[2] g	
N003 =	0.999[0] g	0.999[0] g	
N004 =	0.999[1] g	0.999[1] g	
N005 =	0.994[8] g	0.994[8] g	
TOTAL	4.996[2] g	TOTAL =	4.996[2]g

2. Output total <TOTAL>

⇒ Use the navigation keys **↑**, **↓** to select <Total weight output> and confirm using the **OK**-key.

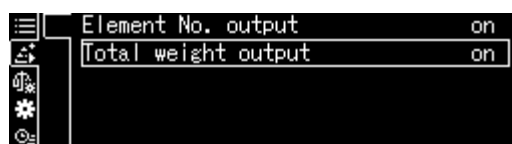

⇒ Select <on> or <off> and confirm using the **OK**-key.

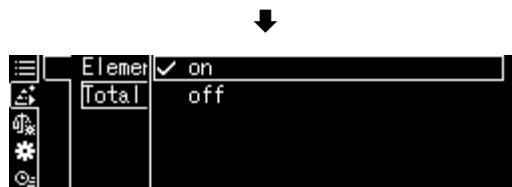

**Sample log
Total weight output <on>**

ADDON MODE	
N001 =	1.004[1] g
N002 =	0.999[2] g
N003 =	0.999[0] g
N004 =	0.999[1] g
N005 =	0.994[8] g
TOTAL	4.996[2] g

**Sample log
Total weight output <off>**

ADDON MODE	
N001 =	1.004[1] g
N002 =	0.999[2] g
N003 =	0.999[0] g
N004 =	0.999[1] g
N005 =	0.994[8] g

⇒ Return to add-on mode by pressing the **ON/OFF**-key.



14.5 Formulation

14.5.1 Free formulating

This function can be applied to add weighing different components of a compound. For monitoring purposes the weight of all components (N001, N002 etc.) as well as the total weight may be issued to an optional printer or PC.

The balance works with a separated memory for the weight of the weighing container and of the recipe components.

1. Selecting an application

⇒ see chap. 11.1.4.



The available applications will be displayed.

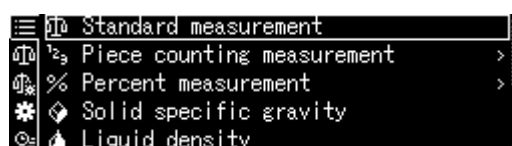

⇒ Use the navigation keys **↑**, **↓** to select <Formulation mode>. The framing will indicate the current selection. Confirm using the **OK**-key.

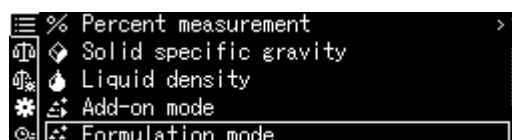

2. Weighing components

⇒ If required, place the empty container on the scale and tare.

⇒ To start the recipe sequence, press the **OK**-key.

If connected to an optional printer, a header will be issued.



⇒ Determine initial weight of first component. Wait until stability display (**→**) has settled down, then press the **OK**-key. The weighing result will be issued automatically and added to the add-on memory. Afterwards automatic taring will take place. The balance is ready to weigh-in the second component.



- ⇒ Weigh additional components as described above.
- ⇒ To complete the recipe, press the **PRINT**-key. The total will be displayed and issued.
- ⇒ To start a new recipe, press the **OK**-key.



Data output:

- ⇒ In recipe mode, press the **MENU**-key.
- ⇒ Use the navigation keys **↑**, **↓** to select <Print setting> and confirm using the **OK**-key.



1. Output item number

- ⇒ Use the navigation keys **↑**, **↓** to select <Element No. output> and confirm using the **OK**-key.
- ⇒ Select <on> or <off> and confirm using the **OK**-key.

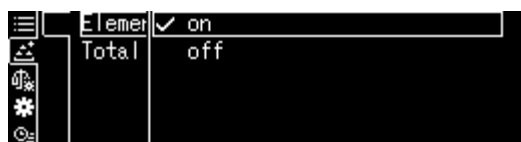
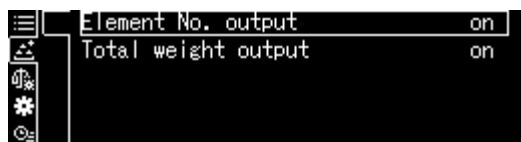

**Sample log
Element No. output <on>**

**Sample log
Element No. output <off>**

FORMULATION MODE			FORMULATION MODE		
N001	=	49.998[2]g			49,998[2]g
N002	=	19.919[1]g			19,919[1]g
N003	=	4.999[9]g			4,999[9]g
TOTAL	=	74.917[2]g	TOTAL =		74,917[2]g

2. Output total <TOTAL>

⇒ Use the navigation keys **↑**, **↓** to select <Total weight output> and confirm using the **OK**-key.

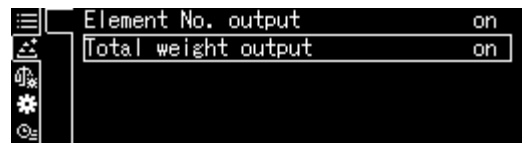

⇒ Select <on> or <off> and confirm using the **OK**-key.

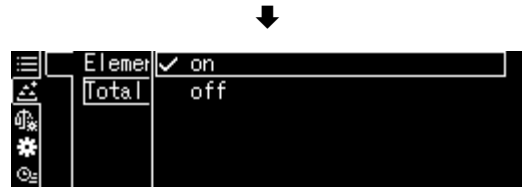

Sample log
Total weight output <on>

FORMULATION MODE	
N001 =	49.998[2]g
N002 =	19.919[1]g
N003 =	4.999[9]g
TOTAL =	74.917[2]g

Sample log
Total weight output <off>

FORMULATION MODE	
	49,998[2]g
	19,919[1]g
	4,999[9]g

⇒ To return to recipe mode, press the **ON/OFF**-key.

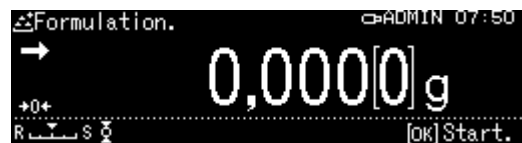

14.5.2 Define and process formulations

The scale has an internal memory for complete recipes and their components as well as the corresponding parameters (such as recipe name, tolerances, automatic taring etc.). During the processing of these recipes the scale will guide you step-by-step through the initial weighing process of components.

+ Defining recipes

1. Selecting an application

⇒ see chap. 11.1.4.



The available applications will be displayed.

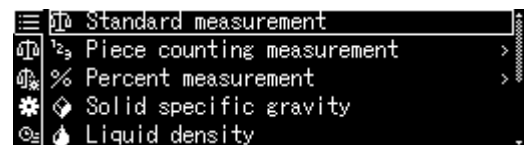

⇒ Use the navigation keys **↑**, **↓** to select <Recipe preparation> .
The framing will indicate the current selection. Confirm using the OK-key.

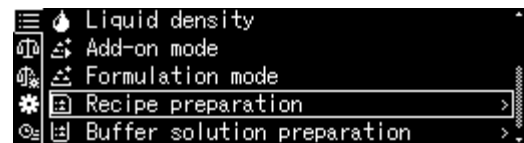

2. Select recipe

⇒ Use the navigation keys **↑**, **↓** select the desired recipe <RECIPE 1 - 5> and confirm using the OK-key.



3. Recipe name (at initial input)

i To **overwrite** a saved recipe please refer to chap. 14.1.4

The display used to enter a recipe name will appear during an **initial input**.
Confirm <Recipe name> by pressing the **OK**-key.

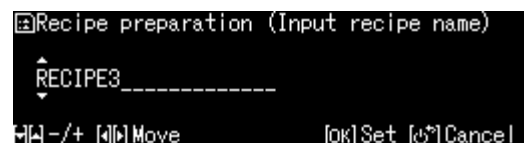
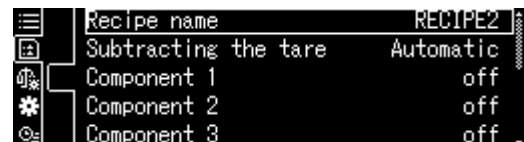

Enter the recipe name such as MiHo-Creme and confirm using the **OK**-key.

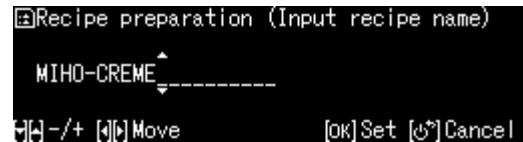

4. Manual and automatic taring after importing individual components.

⇒ Use the navigation keys **↑**, **↓** to select <Subtracting the tare> and confirm using the **OK**-key.

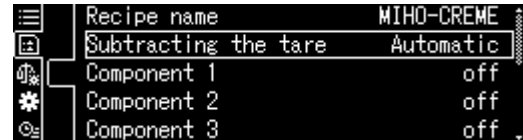

⇒ Select desired setting

Manual:

After saving the weighing value of a component by pressing the **OK**-key taring will take place after pressing the **TARE**-key.

Automatic:

After saving the weighing value of a component by pressing the **OK**-key automatic taring will take place.

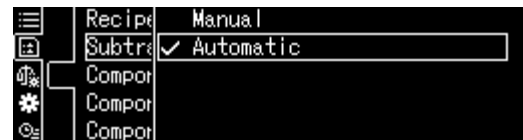

5. Define components

⇒ Use the navigation keys **↑**, **↓** to select a component <Component 1 - 10> and confirm using the **OK**-key.

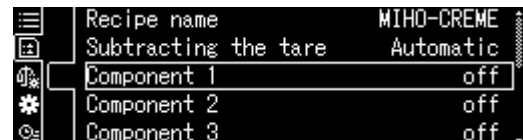

⇒ Use the navigation keys **↑**, **↓** to select <Setting> and confirm using the **OK**-key. Set parameters for component one by one.

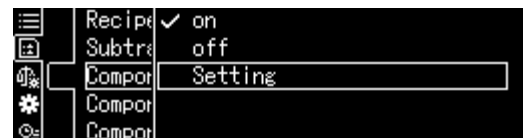

Component name

⇒ Enter component name such as milk (max. 20 characters) and confirm using the **OK**-key

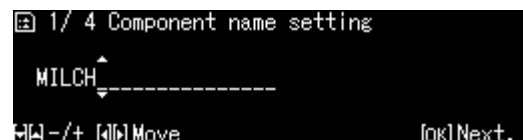
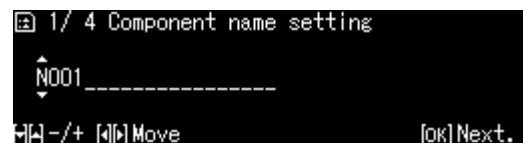

Weighing unit

- ⇒ Select weighing unit and confirm using the **OK**-key

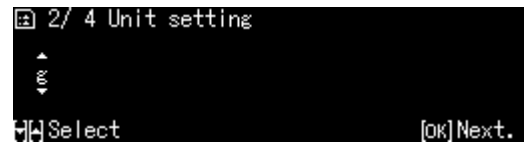

Component weight

- ⇒ Enter weight and confirm using the **OK**-key

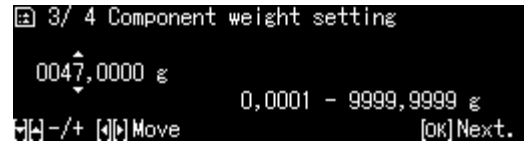

Tolerance of components

- ⇒ Enter tolerance and confirm using the **OK**-key

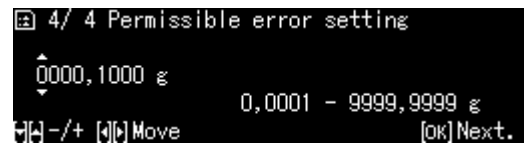

- ⇒ **Repeat step 5 for all components of the recipe**

- ⇒ To return to recipe mode, press the **ON/OFF**-key

+ Process recipe

1. Selecting an application

⇒ see chap. 11.1.4.

The available applications will be displayed.

⇒ Use the navigation keys **↑**, **↓** to select **<Recipe preparation>**. The framing will indicate the current selection. Confirm using the **OK**-key.

2. Select recipe

⇒ Use the navigation keys **↑**, **↓** to select desired recipe such as **MiHo-Creme** and confirm using the **OK**-key.

⇒ The balance is ready for weighing the first component. The number for the component (such as 1 of 6), component name and the target weight will be displayed.

⇒ Load weighing container and tare.

3. Determine initial weight of component

⇒ Determine initial weight of first component. The weighing aid diagram with its tolerance markers facilitates the determination of the initial weight as a target value.

⇒ Wait for stability sign (→) Apply the achieved target value by pressing the **OK**-key.

Depending on the setting, the display will be reset to zero either automatically, or by pressing the **TARE**-key.

The balance is ready to weigh the second component.

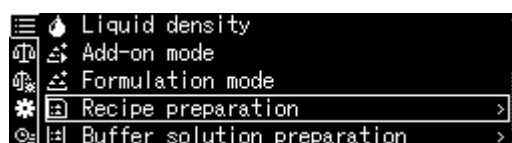
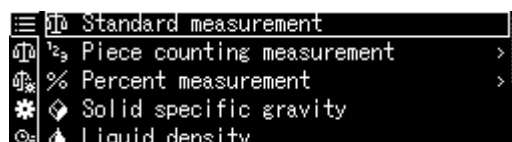

- ⇒ Further components can be weighed as described for the first component. All determined single values applied by **OK**-key will be saved.



4. Completing a formulation

- ⇒ Once the last component has been applied, the result of the recipe will be displayed and issued automatically.
- ⇒ Finish recipe by pressing the **OK**-key. The memory will be deleted. A new formulation may be started.



14.5.3 Change recipe

- ⇒ In recipe mode press **MENU** button.
- ⇒ Select <Changing registration> and confirm using the **OK**-key.
- ⇒ Make changes as described in section "Define recipe".

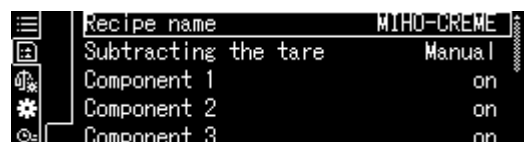

14.5.4 Sample log (KERN YKB-01N):

RECIPE FUNCTION		
NAME		<i>Recipe name</i>
MIHO-CREME		
N001		<i>1. Component</i>
MILK		
TGT=	47.000[0] g	<i>Setpoint</i>
RNG=	0.100[0] g	<i>Tolerance</i>
WEI=	47.014[1] g	<i>Weighed-in quantity</i>
DIF=	0.014[1] g	<i>Deviation from target value</i>
N002		<i>2. Component</i>
ALMOND OIL		
TGT=	95.000[0] g	<i>Setpoint</i>
RNG=	0.100[0] g	<i>Tolerance</i>
WEI=	95.005[7] g	<i>Weighed-in quantity</i>
DIF=	0.005[7] g	<i>Deviation from target value</i>
N003		<i>3. Component</i>
HONEY		
TGT=	8.000[0] g	<i>Setpoint</i>
RNG=	0.100[0] g	<i>Tolerance</i>
WEI=	7.990[6] g	<i>Weighed-in quantity</i>
DIF=	0.009[4] g	<i>Deviation from target value</i>
N004		<i>4. Component</i>
BEZOE-OIL		
TGT=	0.600[0] g	<i>Setpoint</i>
RNG=	0.100[0] g	<i>Tolerance</i>
WEI=	0.600[6] g	<i>Weighed-in quantity</i>
DIF=	0.000[6] g	<i>Deviation from target value</i>
N005		<i>5. Component</i>
OLIBANUM OIL		
TGT=	0.600[0] g	<i>Setpoint</i>
RNG=	0.100[0] g	<i>Tolerance</i>
WEI=	0.611[8] g	<i>Weighed-in quantity</i>
DIF=	0.011[8] g	<i>Deviation from target value</i>
TOTAL =	151,222[8]g	<i>Total</i>



For settings for data output, see chap. 14.5.1 "Data output".

14.6 Preparing buffer solutions

The factory setting provides the scale with the following 13 recipes for preparing buffer solutions

No.	Substance amount concentration	Buffer system	pH value
1	100mM	Phosphoric acid (sodium)	pH = 2.1
2	10 mM	Phosphoric acid (sodium)	pH = 2.6
3	50mM	Phosphoric acid (sodium)	pH = 2.8
4	100mM	Phosphoric acid (sodium)	pH = 6.8
5	10mM	Phosphoric acid (sodium)	pH = 6.9
6	20mM	Citric acid (sodium)	pH = 3.1
7	20mM	Citric acid / caustic soda	pH = 4.6
8	10mM	Tartaric acid (sodium)	pH = 2.9
9	10mM	Tartaric acid (sodium)	pH = 4.2
10	20mM	Acetic acid (ethanolamine)	pH = 9.6
11	100mM	Acetic acid (sodium)	pH = 4.7
12	100mM	Boracic acid (potassium)	pH = 9.1
13	100mM	Boracic acid (sodium)	pH = 9.1

1. Selecting an application

⇒ see chap. 11.1.4.



The available applications will be displayed.

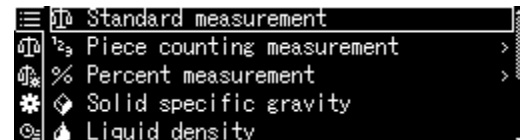

⇒ Use the navigation keys \uparrow , \downarrow to select <Buffer solution preparation>. The framing will indicate the current selection. Confirm using the OK-key.

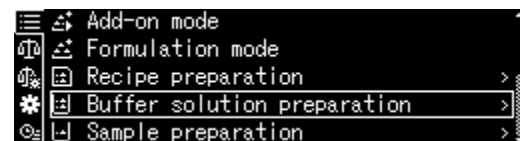

2. Selecting a buffer system

- ⇒ Use the navigation keys \uparrow , \downarrow to select the desired buffer solution from the list and confirm using the **OK**-key.

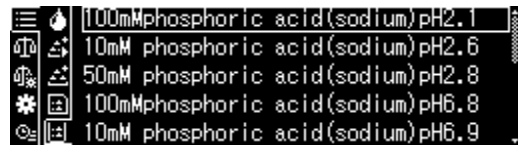

3. Tolerance of components

- ⇒ Press **MENU** button
- ⇒ Select <Permissible error> and confirm using the **OK**-key.
- ⇒ Enter tolerance and confirm using the **OK**-key, selectable 0.0001g – 9.9999g.
- ⇒ To return to the previous menu, press the **MENU**-key.

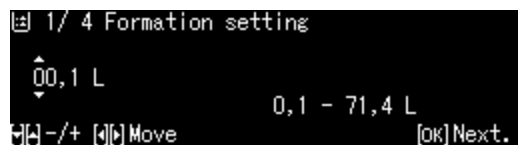
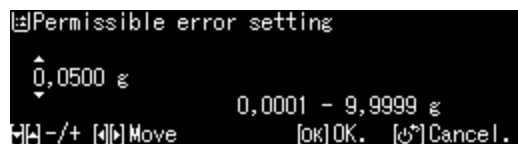
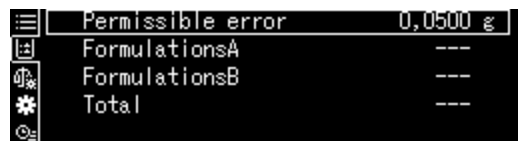
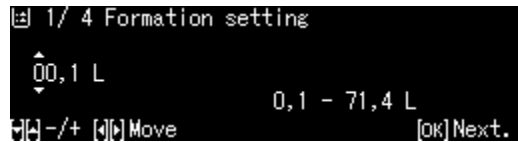

4. Enter volume

- ⇒ Enter volume and confirm using the **OK**-key.
- ⇒ The balance is ready for weighing the first component. Displays the component name and the nominal weight.
- ⇒ Load weighing container and tare.

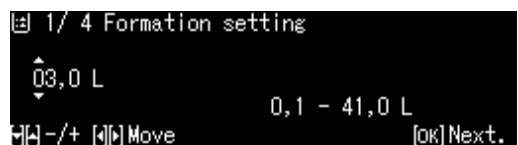

5. Add components

- ⇒ Weigh displayed component.
The weighing aid diagram with its tolerance markers facilitates the determination of the initial weight as a target value.
- ⇒ Wait for stability sign (→). Apply the achieved target value by pressing the **OK**-key.
- ⇒ Add the displayed volume of the second component using a chemical dropper.
- ⇒ Confirm using the **OK**-key

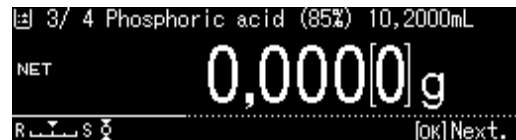

6. Completing a formulation

- ⇒ Once the last component has been applied, the result will be displayed and issued automatically.
- ⇒ Finish by pressing the **OK**-key.
The memory will be deleted. A new formulation may be started.

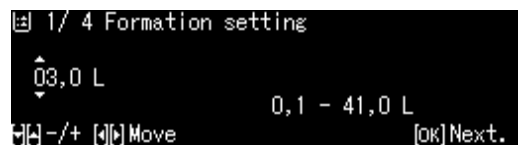

14.7 Sample preparation

This function is used to calculate and prepare standard solutions with a special component based on hydrochloride or hydrate.

The following sample types are available.

Salts (Hydrochloride)	Target weight (g) = $\frac{\text{Molecular weight}}{\text{Molecular weight} - \text{weight of salt} \times 36.45} \times \text{active substance (g)}$
Molecular weight	Target weight (g) = $\frac{\text{Molecular weight}}{\text{Molecular weight of active substance}} \times \text{active substance (g)}$
Hydrate	Target weight (g) = $\frac{\text{Molecular weight}}{\text{Molecular weight} - \text{weight of hydrate} \times 18.02} \times \text{active substance (g)}$
Purity	Target weight (g) = $\frac{100\%}{\text{Purity (\%)}} \times \text{active substance (g)}$

+ Define sample preparation

For selecting application, see chap. 11.1.4



The available applications will be displayed.

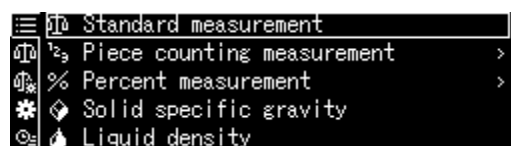

⇒ Use the navigation keys \uparrow , \downarrow to select <Sample preparation>. The framing will indicate the current selection. Confirm using the OK-key.

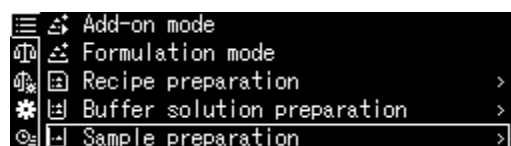

For a first entry the display for entering a memory name will appear.
 Use the navigation keys \uparrow , \downarrow to select a memory space and confirm using the **OK**-key.
 If required, change name and confirm using the **OK**-key.

```

  [Menu] [Back] [F1] SAMPLE01
  [F2] [F3] SAMPLE02
  [F4] [F5] SAMPLE03
  [F6] [F7] SAMPLE04
  [F8] [F9] SAMPLE05
  
```



```

  1/ 4 Sample name setting
  SAMPLE2-----
  [F1] -/+ [F2] Move [OK] Next. [F3] Cancel.
  
```



```

  1/ 6 Sample name setting
  FURSULTIAMIN-----
  [F1] -/+ [F2] Move [OK] Next.
  
```



To overwrite a saved sample please continue by referring to chap. 0

- ⇒ Use the navigation keys \uparrow , \downarrow to select sample type and confirm using the **OK**-key.
 Options:
 <Hydrate>
 <Purity>
 <Molecular weight>
 <Hydrochloride>
- ⇒ Enter the weight for the required active substance and confirm using the **OK**-key.
- ⇒ Enter tolerance and confirm using the **OK**-key.
- ⇒ Enter molecular weight of component and confirm using the **OK**-key.
- ⇒ Enter quantity of chloride groups and confirm using the **OK**-key.
- ⇒ Save by pressing the **OK**-key. The values for the samples will be displayed.

```

  2/ 6 Sample type setting
  Hydrochloride
  [F1] -/+ [OK] Next.
  
```

```

  3/ 6 Collection weight setting
  000,0100 g
  0,0001 - 320,0000 g
  [F1] -/+ [F2] Move [OK] Next.
  
```

```

  4/ 6 Tolerance range setting
  000,0010 g
  0,0001 - 0,0100 g
  [F1] -/+ [F2] Move [OK] END.
  
```

```

  5/ 6 Molecular weight setting
  0398,5400
  36,5000 - 9999,9999
  [F1] -/+ [F2] Move [OK] Next.
  
```

```

  6/ 6 Number of hydrochloride setting
  0001
  1 - 10
  [F1] -/+ [F2] Move [OK] END.
  
```

```

  Sample preparation FURSULTIAMIN
  Target      0,0110 g
  Gross       0,000[1] g
  Picking     0,000[1] g
  +0+
  R-----S
  
```

+ Preparing a sample

1. Select <Sample preparation> application

⇒ See previous paragraph "Define sample preparation"

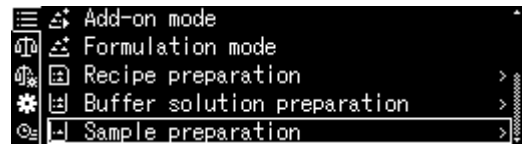

2. Select sample

⇒ Use the navigation keys **↑**, **↓** to select the desired sample and confirm using the **OK**-key.



⇒ The balance is ready for weighing the first component. The number for the component (such as 1 of 6), component name and the target weight will be displayed.



⇒ Load weighing container and tare.

3. Determine initial weight for component

⇒ Weigh the component until the target weight is identical to the gross weight. The weighing aid graph with its markers facilitates matching the initial weight to the target weight.

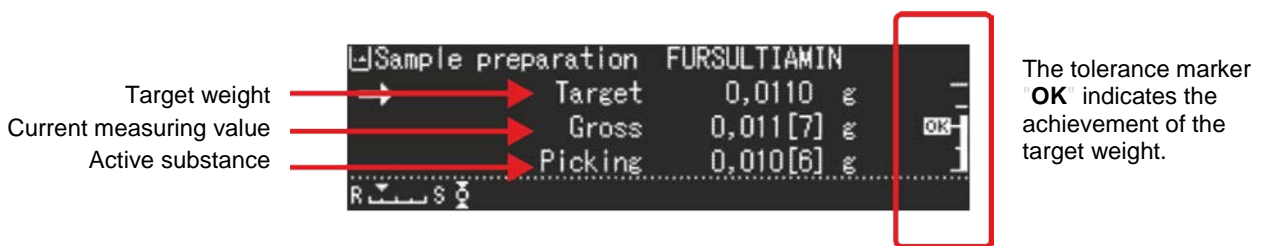
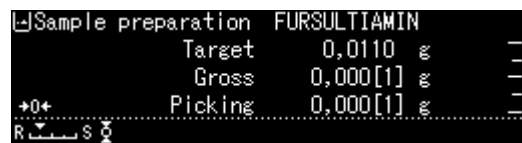

14.7.1 Changing saved samples

⇒ In sample mode press **MENU** button.

⇒ Select <Register active sample> and confirm using the **OK**-key.

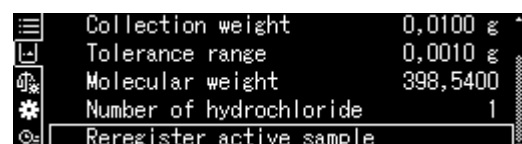

⇒ Make changes as described in the previous paragraph.



14.8 Statistics

The Statistics function facilitates the statistical evaluation of weighing values.

Combinable functions:

Standard weighing mode, parts counting, percentage determination, animal weighing, density determination <Solids>, density determination <Liquids>

1. Select application to be applied to statistics

⇒ see chap. 11.1.4.

The available applications will be displayed.

Use the navigation keys **↑**, **↓** to select the desired application.

The framing will indicate the current selection. Confirm using the **OK**-key.

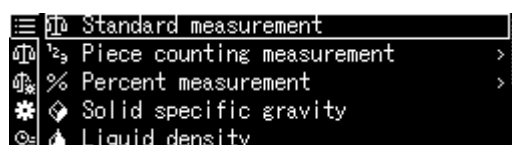

2. Start statistics

⇒ Press **MENU** button.

⇒ Select <Statistical calculation> and confirm using the **OK**-key.

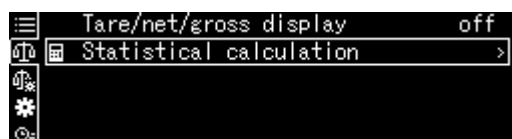

⇒ Start <Start Statistical calculation> and confirm using the **OK**-key. The header will be issued to an optional printer.

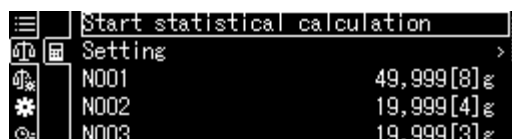

- ⇒ Put first weighed good on weighing platform and wait for stability sign (→).
- ⇒ Save weighing value to statistics by pressing the **PRINT**-key.
- ⇒ Put additional weighed good on platform and save each weighing value to statistics by pressing the **PRINT**-key. Each time you save a value it will be logged automatically.

3. Finish statistics

⇒ Press **MENU** button.

⇒ <End Statistical calculation>
The result will be issued automatically.

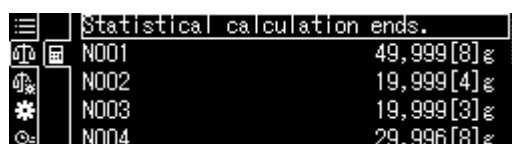

Sample log
Printing element No. <on>

STATISTICS

N001 = 1.0047g
 N002 = 0.9990g
 N003 = 0.9984g
 N004 = 0.9983g
 N005 = 0.9989g

1. Weighing Value
2. Weighing Value
3. Weighing Value
4. Weighing Value
5. Weighing Value

. <RESULT>

N = 5
 T = 4.9993 g
 MAX = 1.0047 g
 MIN = 0.9983 g
 RNG = 0.0064
 MEAN = 0.99986 g
 SD = 0.00272 g
 CV% = 0,00 %
 V = 0,00001

- Number of samples*
- Sum*
- Biggest weight value*
- Smallest weight value*
- Difference smallest / greatest weighing value*
- Mean Value*
- Standard Deviation*
- Relative standard deviation*
- Fraction*
Calculation:

$$s = \sqrt{\frac{1}{n-1} \left\{ \sum (x_i - \bar{x})^2 \right\}}$$

s: Standard Deviation
n Number
x_i: Weighing Value

14.9 Control weighing and target weighing

This function is used to determine the matching of a weighing value to the specified control values.

Control values can be exact target values (target weighing) or the limits set for the tolerance range (control weighing) within which the weighing value is to be kept.

14.9.1 Target weighing

This mode e.g. is used for weighing constant liquid quantities or for assessment of missing quantities or excess quantities.

The target value is the numeric value which corresponds to the nominal quantity of the used unit. Beside the target value a tolerance value is entered. This is a numerical value which is plus/minus over or under the acceptable target value.

Reaching of target value is shown on the diagram. The tolerance marks

HI, **OK** or **LO** indicate whether the weighed good is below, within or above the specified tolerances.

+ Settings

1. Calling Weigh Settings

In weighing mode press **MENU** button.

Press the **R-Taste** key and use the navigation keys **↑**, **↓** to select **<Weighing Settings>** and confirm using the **OK**-key.

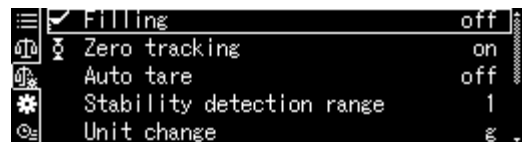

2. Activate function

Use the navigation keys **↑**, **↓** to select **<Target measurement>** and confirm using the **OK**-key.

Select **Settings <on>** and confirm using the **OK**-key.

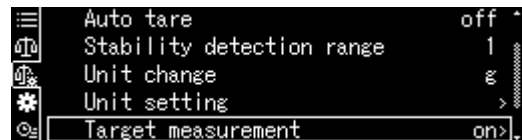

3. Setting target value

⇒ Select **<Setting >** and confirm using the **OK**-key.

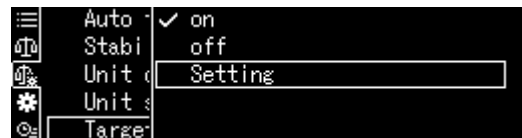

- ⇒ Select <Target value> and confirm using the **OK**-key.

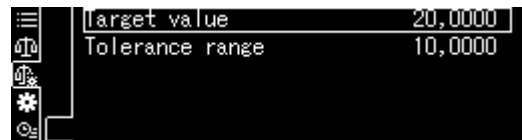

- ⇒ Enter target value and confirm using the **OK**-key.

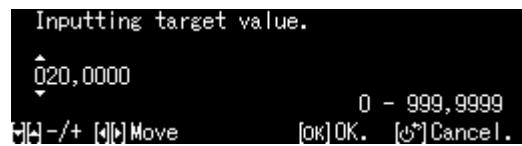

4. Setting tolerance

- ⇒ Select <Tolerance range> and confirm using the **OK**-key.

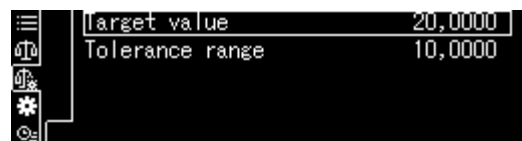

- ⇒ Enter tolerance and confirm using the **OK**-key.

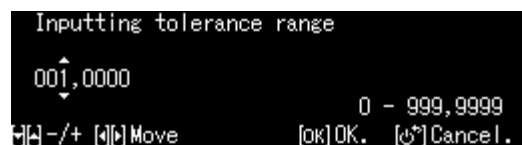

- ⇒ To return to target weighing mode, press the **ON/OFF**-key.



+ Perform target weighing





- ⇒ If required, place empty container on scale and tare.



- ⇒ Place weighed goods and wait until the tolerance mark **HI**, **OK** or **LO** appears. With the help of the tolerance mark check if the weighed goods are under, inside or over the default tolerance.



The tolerance marks provide the following information:

Condition	Grading	Status Tolerance mark	Optical signal	Example: Target value 100g Tolerance 0.0010g
Weight more than the nominal weight and above the upper tolerance	Great difference to target value		flashes slowly (Cycle: 1,5 - 2 s)	< 150 g
	Small difference to target value (<25 %)		flashes fast (Cycle: 0.5 - 1 s)	< 125 g
Weight within tolerance (target value ± tolerance)	Target value accepted		Not flashing	99.9990 – 100.0010 g
Weight less than nominal weight and below the lower tolerance	Great difference to target value (> 25 %)		flashes fast (Cycle: 0.5 - 1 s)	> 75 g
	Small difference to target value		flashes slowly (Cycle: 1,5 - 2 s)	> 50g

14.10 Control weighing (Pass / Fail evaluation)

In many cases not the nominal value of the weighed goods is the decisive parameter, but the deviation from this nominal value. Such applications are for example the weight check of equivalent packages or the process check of parts in a fabrication process.

By entering the upper and lower limit you can ensure that the weighed weighed good remains exactly within the set tolerance range at all time.

If the values of limits are exceeded or not reached this will be indicated by the displayed indicators **HI**, **OK** or **LO**.

+ Settings

1. Calling Weighing Settings

In weighing mode press **MENU** button.

Press the **R-Taste** key and use the navigation keys **↑**, **↓** to select **<Weighing Settings>** and confirm using the **OK**-key.

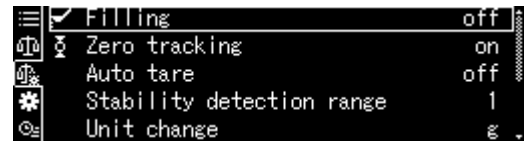

2. Activate function

Use the navigation keys **↑**, **↓** to select **<Pass/fail evaluation>** and confirm using the **OK**-key.

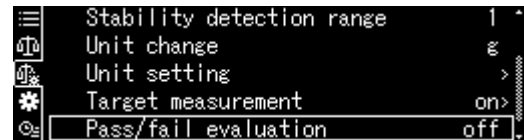

Select **Settings <on>** and confirm using the **OK**-key.



3. Setting limits

⇒ Select **<Setting >** and confirm using the **OK**-key.

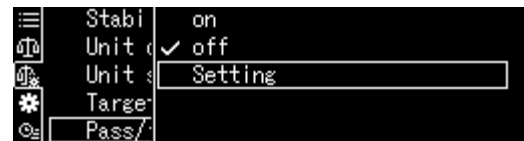

⇒ Define the limits one by one and confirm using the **OK**-key.
When entering the limit values ensure that the values match logically one with another, i.e. the lower limit value must not be greater than the upper one.

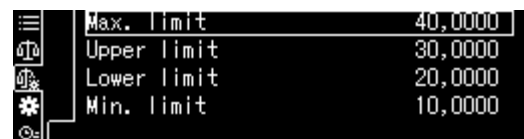

⇒ To return to control mode, press the **ON/OFF**-key

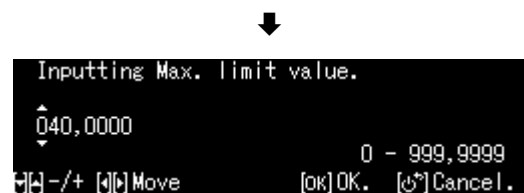

+ Perform control weighing

⇒ If required, place empty container on scale and tare.



⇒ Place weighed goods and wait until the tolerance mark **HI**, **OK** or **LO** appears. Apply the tolerance markers to check whether the weighed good is within the set tolerance range.

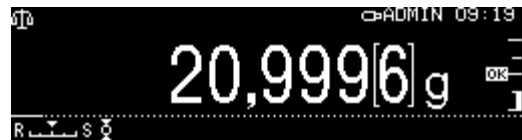

Input example:	Max. limit	40.0000 g
	Upper limit	30.0000 g
	Lower limit	10.0000 g
	Min. limit	20.0000 g

	Weighing Value > Max. limit	> 40.0000g	Beyond tolerance limit. No tolerance mark shown.
Upper limit <	Weighing Value ≤ Max. limit	>30.0000g – 40.0000g	
Lower limit ≤	Weighing Value ≤ Upper limit	≥20.0000g – 30.0000g	
Min. limit ≤	Weighing Value < Lower < limit	10.0000 g – 19.9999 g	
	Weighing Value < Min. limit	< 10.0000 g	Beyond tolerance limit. No tolerance mark shown.

14.11 Minimum sample weight

The default setting for the function "Minimum initial weight" is "locked".

Settings can only be defined locally in connection with a DakkS calibration. For further information please go to KERN-Homepage (www.kern-sohn.com).

15 Interfaces

Via the interfaces weighing data may be exchanged with connected peripheral devices.

Issue may be made to a printer, PC or control displays. In the same way, control commands and data inputs may be made via the connected devices (such as keyboard, barcode reader).

15.1 Connect printer

Turn off scale and printer.

Use a suitable cable to connect the weighing balance to the interface of the printer.

Faultless operation requires an adequate KERN interface cable (optional).

Turn on scale and printer.

Communication parameters (Baud rate, bits and parity) of scale and printer must match, see chap. 15.7

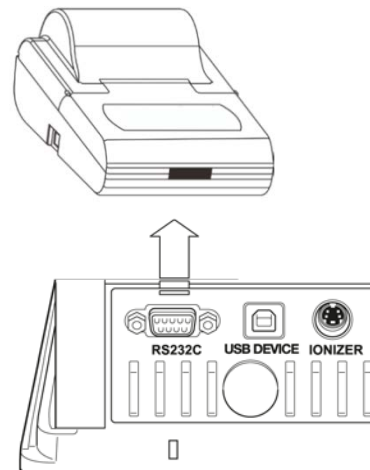

15.2 Connect PC

Turn off scale and connect it to a PC as shown on the diagram.

Switch on balance

The USB driver will be installed automatically.

If required, a suitable driver is available for downloading from our KERN- Homepage www.kern-sohn.com, / Downloads. Select the driver version compatible with your system and execute the exe file.

We recommend our transfer software 'Balance Connection KERN SCD 4.0' for the import of data to a PC program.

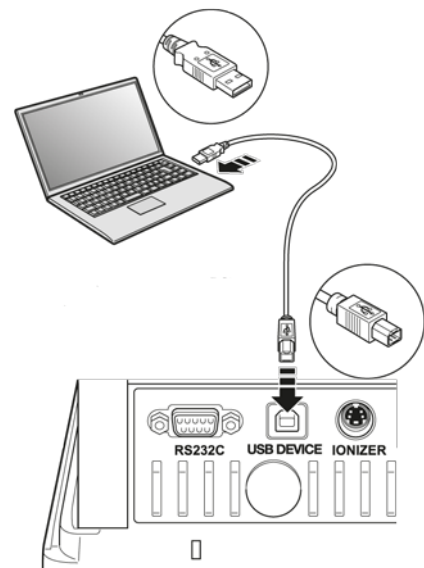

15.3 Connect serial devices / connect programmable controller (SPS / PLC)

Turn off scale and device.

Connect scale to interface of device, using a suitable RS232C cable.

Faultless operation requires an adequate KERN interface cable (optional).

Turn on scale and device.

Adapt communication parameter of scale and device, see chap.

Data is issued or received via the **PRINT**-key or control commands.

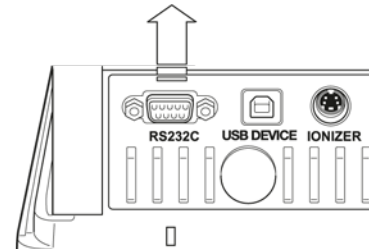
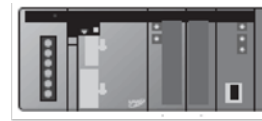

15.4 Interface cable (RS232)

Serial device			Scale 9-pole	
RXD	2	—————	3	TXD
TXD	3	—————	2	RXD
DTR	4	—————	6	DSR
SG	5	—————	5	SG
DSR	6	—————	4	DTR
RTS	7	⌋	7	RTS
CTS	8	⌋	8	CTS

15.5 Data transmission format

1. Standard format example [-123.4567]

	①	②								③		④	
Positon	1	2	3	4	5	6	7	8	9	10	11	12	13
ASCII	2DH	31H	32H	33H	2EH	34H	35H	36H	37H	20H	67H	20H	0DH
Data	-	1	2	3	.	4	5	6	7		g		C/R

No.	Description	
①	Signs	[_] positive values (blanks)
		[-] negative values
②	Weighing Value	Numeric weighing value is displayed in eight positions. Not required positions = space character 20H Possible overload, presented in 2 positions with O L. For scales with type approval the verified value is presented in brackets "[]". This way the data length is increased by two positions.
③	Unit	1 character: Position 12
		3 character: Position 11-13
		4 character: Position 11-14
④	Final character	Separator C/R = 0DH, L/F = 0AH At CR+LF data length will be increased by one position.

2. Stable / unstable weighing value:

Positon	1	2	3	4
ASCII	53H	2D H	31H	32H
Data	S	-	1	2

stable S (53H)
unstabl U (55H)
e













15.6 Interface commands

The weighing balance recognises the commands listed below.

1. Data output

Command	Function
D02	Continuous data output of stable weighing values
D03	Status of stability display is attached to the data in the continuous output (U: unstable; S: stable).
D05	Single output
D06	Automatic output
D07	Single output. Status of stability display is attached to the data in the output (U: unstable; S: stable).
D08	Single output with stable weighing value
D09	Cancel output

2. Key operations

Command	Function
POWER	Press simulation 
DIGIT	Press simulation 
PRINT	Press simulation 
TARE	Press simulation 
CAL	Press simulation 
MENU	Press simulation 
ION	Press simulation 
ENTER	Press simulation 
UP	Press simulation 
DOWN	Press simulation 
LEFT	Press simulation 
RIGHT	Press simulation 

3. Application settings

Command	Function
Standard weighing mode	
R	Quit standard weighing mode
Parts counting	
PCS?	Call function (?: no. 1- 5)
UW?=XX.XXXX	Determine single weight by weighing ?: Nr. 1- 5 XX.XXXX: Weighing Value
UW?	Count parts (?: no. 1- 5)
UB?=XXXXX	Enter single weight as numeric value [XXXXX] (?: no. 1- 5)
UW?	Count parts (?: no. 1- 5)
RECALC	Recalculate single weight
Percentage calculation	
G	% ⇄ g
%?	Select reference ?: No. 1- 3. If no reference is set, the currently loaded weight will be saved as reference (=100%).
% W ? = XX.XXXX	Determine reference ?: Nr. 1 - 3 XX.XXXX: Loaded reference weight = 100 %
% W ?	Percentage calculation (?: No. 1- 3.)
Formulation	
M	Call function
Totalization	
+	Call function
Density determination of solids	
SD	Call function
Determining density of liquids	
LD	Call function

4. Control weighing and target weighing

Command	Function
Target weighing	
TRGT	Call function
TARGET=XX.XXXX	Select target weight
LIMIT=XX.XXXX	Select tolerance
Checkweighing	
CHKW	Call function
OVR.RNG=XX.XXXX	Select max target weight
HI.LIM=XX.XXXX	Select upper tolerance
LOLIM =XX.XXXX	Select lower tolerance
UND.RNG=XX.XXXX	Select min target weight
Start tolerance check	
G	HL: Outside upper tolerance range
	HI: Weight greater than target weight
	OK Weight within tolerance
	LO: Weight lower than target weight

5. Adjustment and weighing units

Command	Function
Adjustment	
ICAL	Internal adjustment
ECAL	External adjustment
ECAL.W=XXX.XXXX	Enter weight value for external adjustment weight (XXX.XXXX) [g].
Weighing Units	
g	Activate the weighing unit, in which can be toggled with the UNIT key.
mg	
ct	

6. System Settings

Command	Function
Software scale	
ID=XXXX	Select scale ID no. default setting [0 0 0 0]
ID	Display scale ID no.
STATE	List of current menu settings printed
TIME	Display date / time
User administration	
LOGIN=XXXX: YYYY	Login XXXX: User name (max 20 characters) YYYY: Password (4 characters)
LOGOUT	Logout
UID	Display currently logged-in user

7. Miscellaneous

Command	Function
TYPE	Model
VER	Software version
SN	Serial number
MAX	Weighing range (max)
MIN	Minimum load (Min)

15.7 Communication parameters

All communication parameters will be set (See chap. 15.7.1) by calling a standard setting.

The subsequent standard setting must be selected according to the printer (details see the following table).

All parameters may be of course also set in a user specific way (See chap. 15.7.2).

Menu selection	Standard	Extended	Type M	Type S	Type A	User setting	
Manufacturer	Shimadzu (Standard)	Shimadzu *	Mettler	Sartorius	A-D	-	- Setting for KERN YKB-01N
Baud Rate	1200	1200	2400	1200	2400	user-defined	9600
Parity	None (8)	None (8)	Even (7)	Odd (7)	Even (7)	user-defined	None (8)
Stop bit	1	1	2	2	2	user-defined	1
Handshake	Hardware	Hardware	off	Hardware	off	user-defined	off
Data format	Shimadzu Standard	Shimadzu Standard	Mettler Standard	Sartorius Standard	A-D Standard	user-defined	FREE
Separator	C/R	C/R	C/R + L/F	C/R + L/F	C/R + L/F	user-defined	C/R

*only if the balance can send a feedback to the PC (without error: OK [C/R], at error NG [C/R]).

15.7.1 Select standard setting

1. Call function

Press and hold **PRINT**-key for approx. 3 sec.

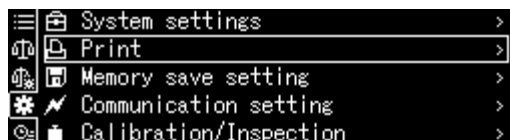

Use the navigation keys to select <Communication setting> and confirm using the **OK**-key.

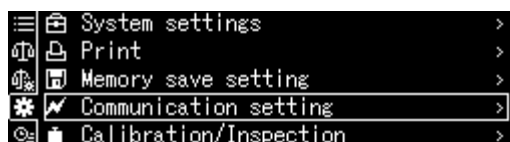

Use the navigation keys to select interface and confirm using the **OK**-key.



2. Select setting

The available settings will be displayed, see chap. 15.7

- Standard
- Extended
- Type M
- Type S
- Type A
- User setting

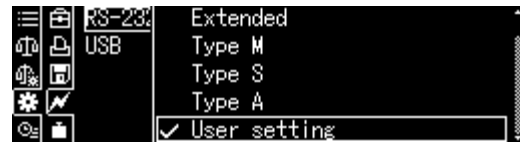

Select Settings with the help of the navigation keys and confirm using the **OK**-key.

Use the **ON/OFF** button to return into weighing mode



15.7.2 User defined settings (display example for KERN YKB-01N)

Every communication parameter can be set individually in the menu item "User setting".

Call function:

Press and hold **PRINT**-key for approx. 3 sec.



Use the navigation keys to select <Communication setting> and confirm using the **OK**-key.

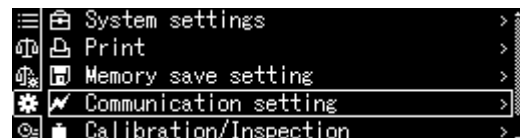

Use the navigation keys to select interface and confirm using the **OK**-key.



Use the navigation keys to select <User setting> and confirm using the **OK**-key.

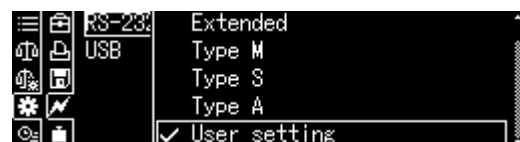

Setting communication parameters:

Use the navigation keys to select the available settings one by one and confirm using the **OK**-key.

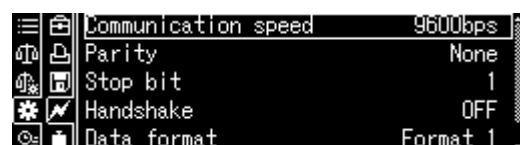

1. Communication speed (Baudrate)

Use the navigation keys to select <Communication speed> and confirm using the **OK**-key.

Select setting and confirm using the **OK**-key.



2. Parity

Use the navigation keys to select <Parity> and confirm using the **OK**-key.

Select setting and confirm using the **OK**-key.

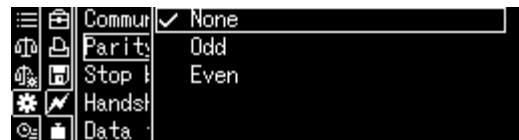

None	Small parity, 8 bit
Odd	Odd parity, 7 bit
Even	Straight parity, 7 bit

3. Stop bit

Use the navigation keys to select <Stop bit> and confirm using the **OK**-key.

Select setting and confirm using the **OK**-key.

1	1 bit
2	2 bit

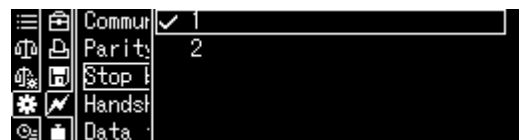

4. Handshake

Use the navigation keys to select <Handshake> and confirm using the **OK**-key.

Select setting and confirm using the **OK**-key.

OFF	No handshake
HARD	Hardware Handshake
SOFT	Software Handshake
TIMER	Timer Handshake



5. Data format

Use the navigation keys to select <Data format> and confirm using the **OK**-key.

Select setting and confirm using the **OK**-key.

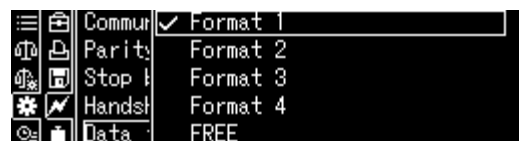

- Format 1** Shimadzu Standard
- Format 2** Shimadzu Extended
- Format 3** Mettler Standard
- Format 4** Sartorius Standard
- FREE** Options:
byte 1 -99, Data length 1 -99

6. Final character

Use the navigation keys to select <Delimiter> and confirm using the **OK**-key. Select setting and confirm using the **OK**-key.



Return to weighing mode

Press **ON/OFF** repeatedly or for 3 s.

15.8 Issue functions

15.8.1 Automatic data output / Auto Print function

Data output happens automatically without having to press the **PRINT**-key as soon as the corresponding output condition has been met, dependent on the setting in the menu.



The  icon will be displayed while the function is enabled.

Not combinable with the continuous data output.

Call function:

Press and hold **PRINT**-key for approx. 3 sec. <Print> Confirm using the **OK**-key.

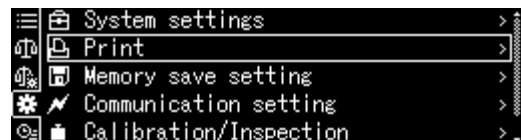

Select Settings <Auto print> and confirm using the **OK**-key.

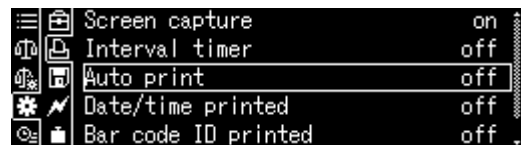

Select Settings <on> and confirm using the **OK**-key.

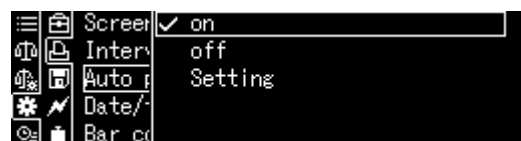

Set output condition:

Use the navigation keys to select <Setting> and confirm using the **OK**-key.

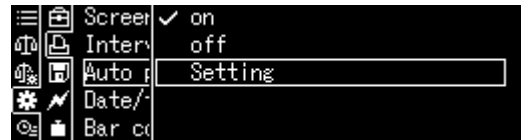

Use the navigation keys to select the desired setting and confirm using the **OK**-key.

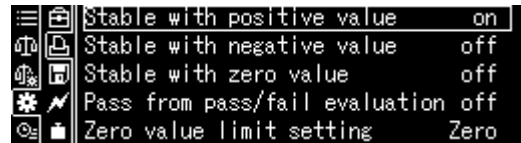

Stable/positive value	Single output for stable and positive weighing value.	
Stable/negative value	Single output for stable and positive or negative weighing value.	
Stable at zero	Single output for stable and positive weighing value. New output only after zero display and stabilisation	
Pass/ Fail	If the Auto Print function is connected to the check weighing function, data of stable weighing values are output with indicator display OK ..	
Set zero value limit	[Zero]	Another output when the display goes back to zero. Setting for priority of accuracy
	[50 % of previous output]	Another output when the display goes back to 50% of the previous weighing value. Setting for priority of accuracy

Return to weighing mode

Press the **ON/OFF** button.
From here on the Auto Print function is active, the indicator  is displayed.

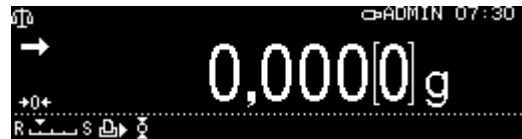

Place goods to be weighed on balance.

- ⇒ If required, place empty container on scale and tare.
- ⇒ Place weighed goods and wait until the stability display (➔) appears. The weighing value is issued automatically.
- ⇒ Remove the weighed good.

15.8.2 Continuous data output



The  icon will be displayed while the function is enabled.
Not combinable with automatic data output.

Call function:

Press and hold **PRINT**-key for approx. 3 sec.
<Print> Confirm using the **OK**-key.

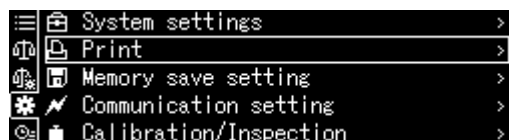

Select Settings <Interval timer> and confirm using the **OK**-key.

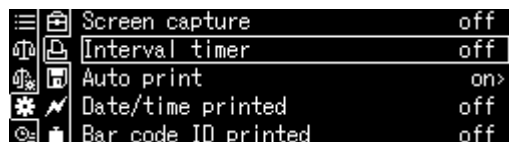

Select Settings <on> and confirm using the **OK**-key.



Setting output interval:

Use the navigation keys to select <Setting> and confirm using the **OK**-key.

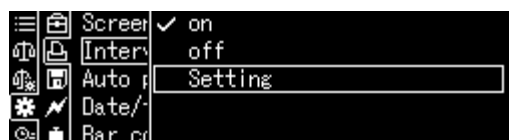

Use the navigation keys to select Interval and confirm using the **OK**-key, selectable 00:00 – 99:59 min.

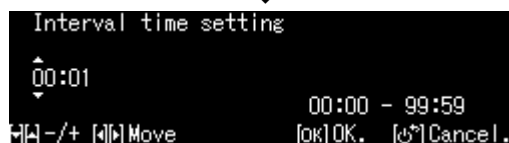

Return to weighing mode

Press the **ON/OFF** button.
From that point onwards continuous data output will be enabled and the indicator  will be displayed.



Place goods to be weighed on balance.

- ⇒ If required, place empty container on scale and tare.
- ⇒ Place goods to be weighed,
- ⇒ The weighing values are issued according to the defined interval.



Continuous data output may be cancelled and restarted with the help of the **PRINT**-key.

15.8.3 GLP Output Function

With the GLP Output function the printouts of weighing results are completed with a bottom row and a head line. The content of the header and footer are selectable.

Call function:

Press and hold the **CAL**-key for approx. 3 sec.

Confirm <GLP output> by pressing the **OK**-key.

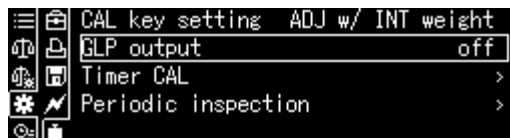

Select Settings <on> and confirm using the **OK**-key.

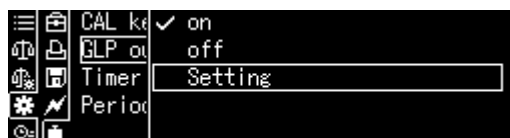

Set output condition:

Use the navigation keys to select <Setting> and confirm using the **OK**-key.

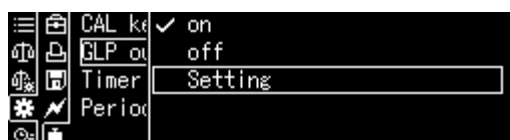

Use the navigation keys to define the contents for the header and footer one by one, each time confirming by pressing the **OK**-key.

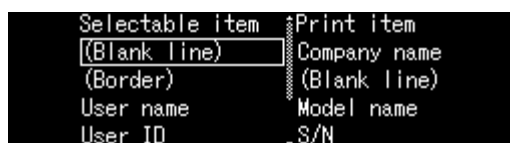

Return to weighing mode

Press the **ON/OFF** button.

- + Enter scale identification number, see chap. 13.3

15.8.4 Defining output details

When the function is enabled you can in addition to weighing value issue the date, time, barcode ID and sample name.

Call function:

Press and hold **PRINT**-key for approx. 3 sec.

Confirm <Print> using the **OK**-key.

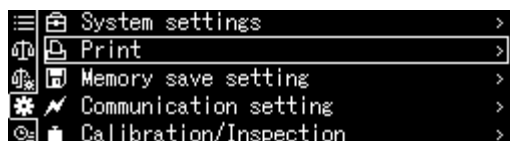

Setting output details:

Use the navigation keys to enable [on] the desired details one by one [on], confirming each time by pressing the OK-key.

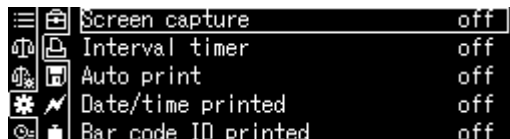

- Date/time printed
- Barcode ID printed
- Sample ID printed

Return to weighing mode: Press the **ON/OFF** button.

Sample log:

----- DATE 2018 Oct. 07 TIME 18:31:34 23456780123456789012 AAAAA0008 175.9320 g -----	<i>Date</i> <i>Time</i> <i>Barcode ID (max. 22 characters)</i> <i>Sample description</i> <i>Measuring Value</i>
---	---



You may also define the output details via System Settings (See chap. 11.1.3).

The barcode ID may also take place with the help of a barcode reader or a PC keyboard.

15.10 USB connection





The USB interfaces are used to issue adjustment and weighing data. In the same way control commands and data entries may be entered via the connected devices (PC keyboard, barcode reader).

Connecting devices:

- Switch off the balance
- Connect USB equipment as shown on the diagram
- Switch on balance.



USB equipment and application.

			
<p>Save weighing data and adjustment logs</p>	<p>Data input</p>	<p>Data transmission</p>	<p>USB Hub</p>

15.10.1 Edit weighing data, adjustment logs and screenshots to USB medium

□ Preparation

Call function

Call System Settings

Use the navigation keys **↑**, **↓** to select <Memory save setting> and confirm using the **OK**-key.

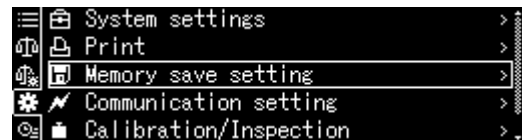

The available menu items will be displayed.

- Save measured values to USB
- Save adjustment data to USB
- Issue internal memory
- File format USB (txt or CSV)

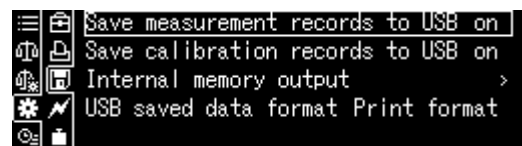

Select file format:

Use the navigation keys to select <USB saved data format> and confirm using the **OK**-key.

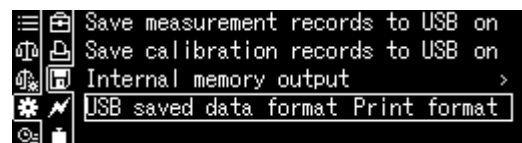

Confirm desired setting by pressing the **OK**-key.

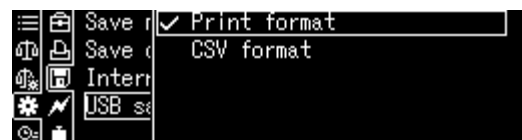

Return to weighing mode: Press the **ON/OFF** button.

⇒ **Save displayed value as screenshot**

Call System Settings



Use the navigation keys to select **↑**, **↓** <Print> and confirm using the **OK**-key.



To enable <Screen capture> select Setting <on> and confirm using the **OK**-key

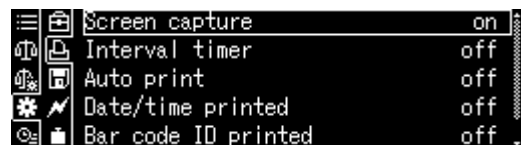

Connect the scale to a PC keyboard by means of a USB hub, as shown on the diagram.

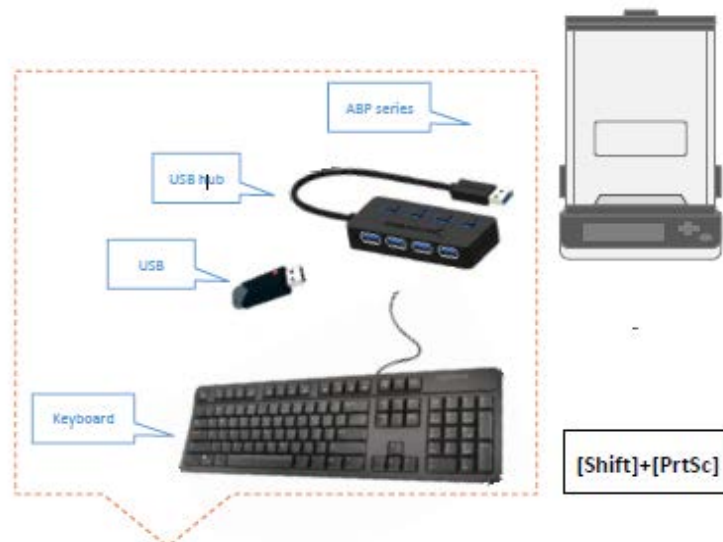

Save screenshot by pressing **[Shift] + [Print]** to USB stick.

⇒ **Issue internal memory**

Call Menu Item <Issue Internal Memory> as described above under "Preparation".

Confirm using the **OK**-key

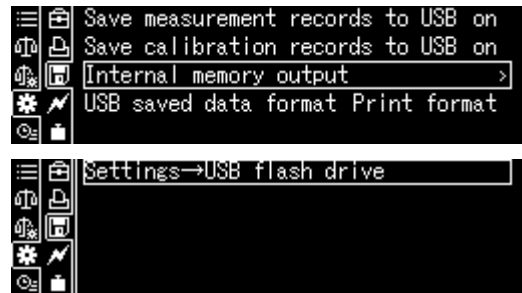

Confirm using the **OK**-key, data will be issued.



Return to weighing mode: Press the **ON/OFF** button.

15.10.2 Data transfer by means of barcode reader

Call System Settings and confirm using the **OK**-key.

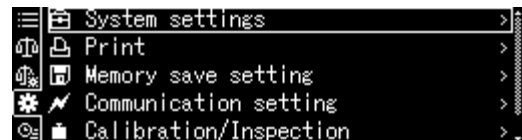

Use the navigation keys to **↑**, **↓** to select <Barcode transfer> and confirm using the **OK**-key.



The available menu items will be displayed.

- Transfer: All data
- Without commands
- No transmission

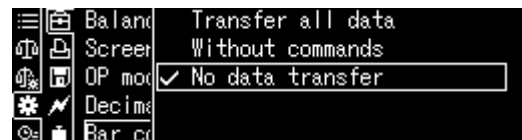

Confirm desired setting by pressing the **OK**-key.

Return to weighing mode: Press the **ON/OFF** button.

Application example for easy log-on (without password entry):

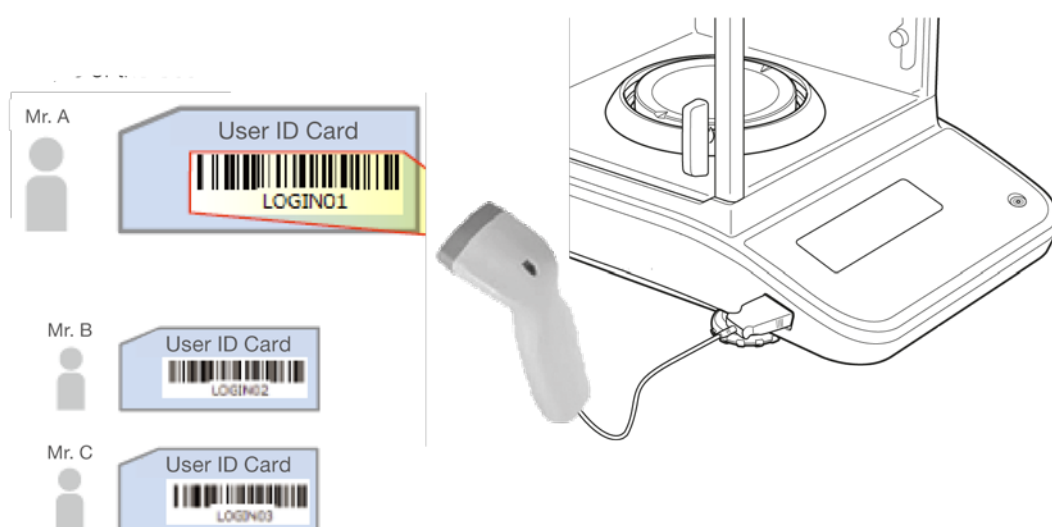

16 Servicing, maintenance, disposal

16.1 Cleaning



Before any maintenance, cleaning and repair work disconnect the appliance from the operating voltage.

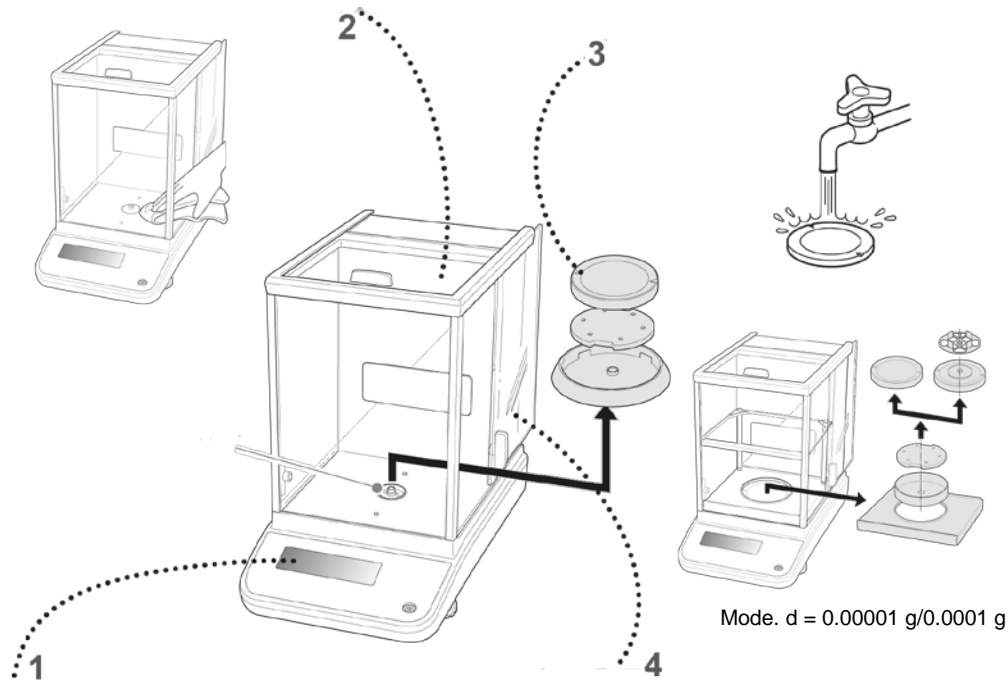

Fig.1: Clean the balance

1. Display

Please do not use aggressive cleaning agents (solvents or similar agents), but a cloth dampened with mild soap suds.

2. Housing

Please do not use aggressive cleaning agents (solvents or similar agents), but a cloth dampened with mild soap suds. Take care that the device is not penetrated by fluids and polish it with a dry soft cloth.

Loose residue sample/powder can be removed carefully with a brush or manual vacuum cleaner.

Spilled weighing goods must be removed immediately.

3. Weighing pan

Remove weighing plate, clean it wet and dry it before installation

4. Glass doors

These may be removed as described below and cleaned with a commercial glass cleaner.

Handle glass doors with care.

Attention: Risk of breakage

Risk of cuts.

Keep away your hands/fingers from the running rail.



1. Remove, screening ring, weighing plate and carrier of weighing plate

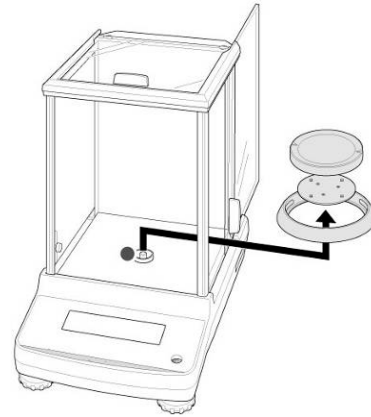

2. Remove the plastic handle by turning.



Do not touch the support of the weighing plate. This could cause damage to the balance.

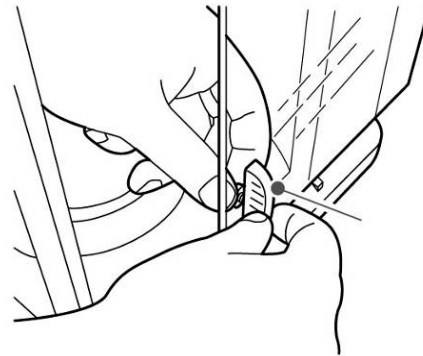

3. Remove glass door carefully acc. to fig.

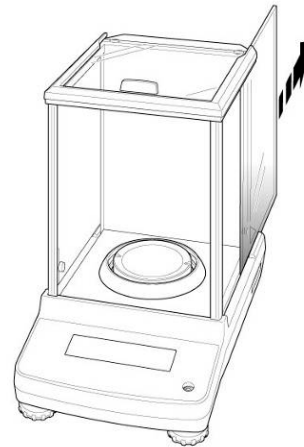

Fig.2: Remove the glass doors

4. Re-install the glass door in reverse order.



To secure the glass door always reattach the plastic handle.

16.2 Servicing, maintenance

- ⇒ The appliance may only be opened by trained service technicians who are authorized by KERN.
- ⇒ Before opening, disconnect from power supply.

16.3 Disposal

Disposal of packaging and appliance must be carried out by operator according to valid national or regional law of the location where the appliance is used.

17 Instant help

Possible causes of errors:

In case of an error in the program process, briefly turn off the balance and disconnect from power supply. The weighing process must then be restarted from the beginning.

Fault	Possible cause
The displayed weight does not glow.	<ul style="list-style-type: none">• The balance is not switched on.• The mains supply connection has been interrupted (mains cable not plugged in/faulty).• Power supply interrupted.
The displayed weight is permanently changing	<ul style="list-style-type: none">• Draught/air movement• Glass doors not closed• Table/floor vibrations• Weighing pan has contact with other objects.• Electromagnetic fields / static charging (choose different location/switch off interfering device if possible)
The weighing result is obviously incorrect	<ul style="list-style-type: none">• The display of the balance is not at zero• Adjustment is no longer correct.• The balance is on an uneven surface.• Great fluctuations in temperature.• Electromagnetic fields / static charging (choose different location/switch off interfering device if possible)
The desired weighing unit cannot be called by UNIT key.	<ul style="list-style-type: none">• Unit was not activated beforehand.
Automatic adjustment carried out frequently.	<ul style="list-style-type: none">• Severe temperature variations in the room or the instrument
No data transfer between printer and balance.	<ul style="list-style-type: none">• Communication settings are wrong.
The menu settings cannot be changed.	<ul style="list-style-type: none">• The menu is locked Remove the menu lock.









18 Ionizer (factory option)

18.1 General

The ionizer has conductive peaks supplied by high voltage which, based on corona discharge, generate positively and negatively charged ions in the immediate vicinity. These are attracted by the electrostatic charge of goods to be weighed and, thus, neutralise the interfering electrostatic charge. This also does away with the forces falsifying the weighing (such as falsified weighing result, weighing value drifted).

18.2 Basic Safety Precautions

WARNING

-  The use of ionizer is only intended in combination with electronic weighing balances. Do not use for any other purposes.
-  Never operate the ionizer in explosive environment. The serial version is not explosion protected.
-  Protect the ionizer against high air humidity / temperature, steams and dust;
Take care to select a location free of water and oil
Do not expose the ionizer to strong humidity for extended periods. Non-permitted condensation (condensation of air humidity on the appliance) may occur if a cold appliance is taken to a considerably warmer environment. In this case, acclimatize the disconnected ionizer for ca. 2 hours at room temperature.
-  Whilst the ionizer is switched on, do not touch the ion source; see sticker on the left side.
-  In case of smoke development, smell of fire, strong heating-up of the ionizer or when the red LED starts glowing, turn off the ionizer immediately and disconnect it from the mains.
-  If water or other foreign matter enters the ionizer, turn off the master switch immediately and disconnect it from the mains.
-  On account of the high voltage technology, handle the ion source and exits with care.
-  Do not take apart or modify the ionizer.



Prevent damage caused by dropping, vibration or shock; see sticker on the left side.



Always use the genuine power pack. The stated voltage value must be the same as the local voltage.



Risk of injury! The peaks of the ion source are sharp and cutting.



The ionizer generates poisonous ozone; ensure sufficient ventilation.



For maintenance and repair work disconnect the ionizer from the mains.



Disconnect the ionizer from the mains during periods of idleness.



CAUTION



Maintain and clean the ionizer at regular intervals.

Cleaning of electrode probes: Every 1 000 hours

Replacement of electrode probes: Every 30 000 hours



Starting up a damaged ionizer may result in a short circuit, fire or electric shock.



Starting up out of doors and inside vehicles is prohibited and will result in total loss of warranty.



The occurrence of electromagnetic fields may result in major display deviations (incorrect weighing results). Discharge sample at a sufficient distance from the weighing balance.



During normal operation the green LED [POWER] will be glowing, in case of a breakdown the red LED [ALARM].

If the red LED is glowing, turn off the ionizer at the master switch and turn it on again. If the red LED continues to glow, inform the manufacturer.

The Blue LED [RUN] on the front of the ionizer illuminates to indicate that the instrument is now generating ion for static removal operation.



There is sound of operation during an ion generation, it is not failure.

18.3 Technical Data

Ion Generation Method	AC corona discharge method
Discharge time ($\pm 1000V \rightarrow \pm 100V$)	1 secpnd
Ozone concentration	0.06ppm (150 mm from the outlet)
Ambient conditions	0- 40 °C, 25 – 80 % air humidity (non-condensing)
Electric Supply	Mains adapter: Input AC 100V - 240V, 0.58 A, 50 - 60 Hz Output DC 24V, 1 A Ionizer: 200 mA
Pollution Degree	2
Overtoltage category	Category II
Installation Site	Device may only be used indoors

18.4 Commissioning

Switch on balance

Connect network adapter of ionizer to scale, as shown on diagram.

Connect network adapter of ionizer to power supply.

Turn on ionizer as shown on diagram [on].

The display   lights up.

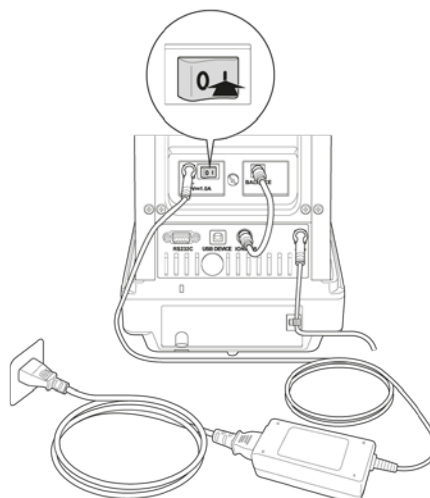

Ionization

Check to make sure that the green LED [Power] indicator light for the ionizer is illuminated.

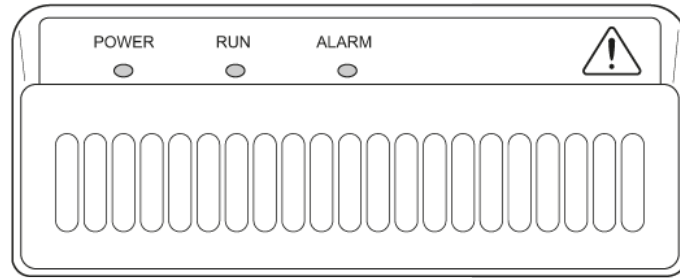

Close wind protection doors.

Press key \oplus \ominus to start ionization. The blue LED [RUN] on the front of the ionizer illuminates to indicate that the instrument is now generating ion for static removal operation. The length of time depends on the menu setting <System Settings \rightarrow Ion irradiation time>.

Set irradiation time for ions

Call System Settings and confirm using the OK-key.

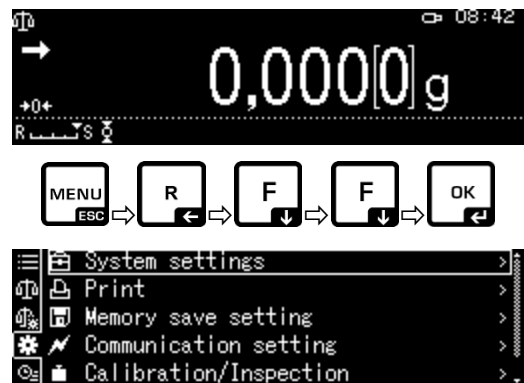

Use the navigation keys to \uparrow , \downarrow to select <Ion irradiation time> and confirm using the OK-key.



Confirm desired setting by pressing the OK-key.

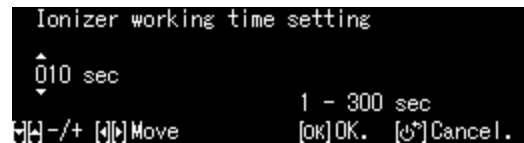





Return to weighing mode:

Press the ON/OFF button.

18.5 Maintenance and cleaning

- i** Be sure to carry out maintenance and cleaning work on a regular basis.
- Cleaning of electrode probes: Every 1 000 hours
Replacement of electrode probes: Every 30 000 hours

 WARNING	
	Disconnect the device from the mains before cleaning.
	Do not disassemble
	Gently wipe the electrode probes without bending them.

Cleaning

Do not use aggressive cleaning agents (solvents etc.) instead clean with a soft cloth soaked in mild soap suds. Take care that the device is not penetrated by fluids and polish it with a dry soft cloth.

Remove loose sample residues / powder carefully with the help of a brush or hand-held vacuum cleaner.

For cleaning the ion source use the supplied cleaning brush or a cotton stick moistened with alcohol. Take care that the peaks are not bent.

When the internal part of the electric discharge section is dirty, please blow off the dirt inside with an air compressor gun / air duster (dry type, which do not spray cleaning solution while blowing), etc.