

EKH 30-G

Order symbol: EKH 30-G

Product nbr: 3730147

Description: Cover

Remarks: Opaque. PC

Including:

EAN: 64 18074000200

EI. number:

- Finland: 3420151
- Denmark: 8212007026
- Sweden: 2537852

Sample image

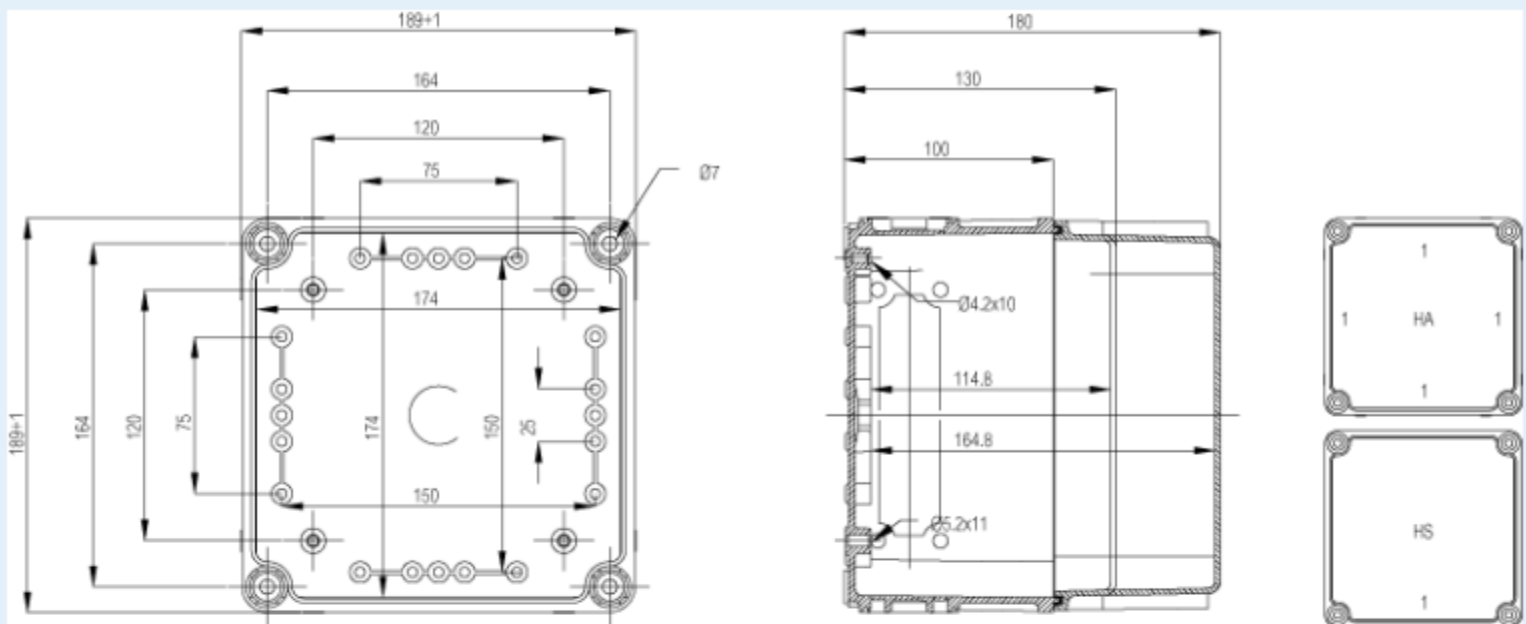

Dimensions:	Height	Width	Depth
mm:	190	190	30
inch:	7.48	7.48	1.18

Materials:

Material:

Base colour:

Cover colour:

Gasket material:

Temperatures:

Temperature °C (short term): -40 ... 120

Temperature °C (continuous):

Temperature °F (short term): -40 ... 250

Temperature °F (continuous): -40 ... 175

Accessories:

EKHVT Back Panel. for enclosures:
(148 x 148 x 1)

EKV 12 DIN-35 Mounting rail. for enclosures:
(160 x 35 x 1)

Rating:

Ingress protection (EN 60529):

Impact Resistance (EN 62262):

Electrical insulation: Not insulated

Halogen free (DIN/VDE 0472, Part 815): 0

UV resistance: -

Flammability Rating:

Glow Wire Test (IEC 695-2-1) °C: C

NEMA Class

Certificates:

SGSFIMKO_EK