

QU-CM-5510/-2



MOTORIZED CARD READER MODULE

USER MANUAL

I . BRIEF INTRODUCTION

It is the first dual shutter protection card reader in the world. The first shutter is mechanical with dust and foreign things prevention function, and the other one is for motor protection. The main body is composite plastic with high temperature, abrasion and aging resistance, and two sides of card movement channel are embedded with stainless steel metal. It makes product with advancement in strength and precision. Module installation structure is convenient for customers to maintain product. Elaborate design and part combination makes product with fresh appearance and its precision meets or overpass the same product all over the world. Excellent circuit design takes multiple protection functions into consideration. It is a card reading equipment that can read or write many types of cards, supporting 8 pieces SIM card operation.

※ Model Name Rules

R

Card Type	IC Card	Mag-Card	RFID Card	SIM Card
Model Name	(R&W)	(R)	(R&W)	(Encryption)
QU-CM-5510/-2-A	Support any one of the three types card			N.A
	Support any two of the three types			Or any one with SIM card encryption
QU-CM-5510/-2-C	Support all the three types			Or any two with SIM card encryption
QU-CM-5510/-2-D	Support all the three types with SIM card encryption			

※ R&W: Read & Write



Picture without SIM card slot



Picture with SIM card slot

II. FEATURES & SPECIFICATIONS

Subject	Specification
Magnetic card Reading	Accordance with ISO7810 7811 standard card
IC card Reading & Writing	EMV、7816 PBOC 3.0
RF card Reading & Writing	S50、S70、ID card
SIM card operation	8 SIM card ports
Card entry method	Magnetic signal, Optoelectronic signal and rear card insert
Motor shutter	Allow or enabled card to insert
Mechanical shutter	Prevent dust and foreign things
Alert Lamp	Card entry alert, power on alert, IC card power on alert
Card stop position	Multiple card stop position
Input voltage detection	have protection alert when voltage is above 13v or below 11V
Input voltage protection in negative direction	Not above 40V

III. PARAMETERS

Operation Power	DC 12 V (MAX CURRENT 3A, Static current 100mA), Recommend : 12V/3A
Operation Te-mp.&Humi.	0 °C ~ 50 °C , 30~90% (Relative Humidity)
Interface	RS232 serial port , Support 2400~ 38400BPScommunication rate
Card size :	Card width : 54±0.5mm Card length : 85±0.5mm Card thickness : 0.2-2.0mm
Card material :	Paper card or polyester card
Weight :	about 1.3kg
Magnetic card type	ISO7810 , ISO7811 (1-6—) , ISO7812 , ISO7813 And ISO15457
contact IC card type	ISO7816 normal storage card,logic encryption card, and smart card(CPU card), reading and writing support
contactless IC card type	ISO14443 TYPEA TYPEB 1、5693 contactless card reading and writing
Dimensions	145.5(L) x 84.1(W) x 47.4 (H) mm
Net weight	1.5KG
Lifespan	Magnetic head:800, 000 times IC card contact point:500, 000 times Trans. Equipment:500, 000 times

IV. INTERFACE EXPLANATION AND CONNECTION

NOTE: TO AVOID sudden high power damage, please do connect the communication wire before connect the Power cable.

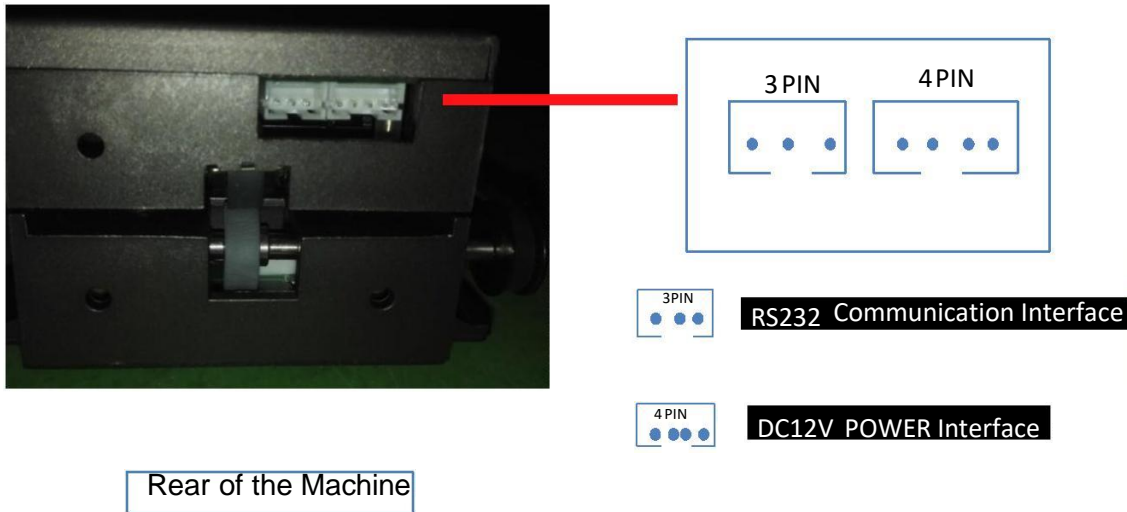

RS232 Interface

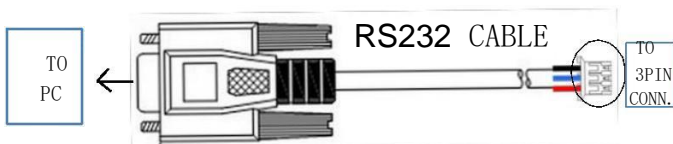
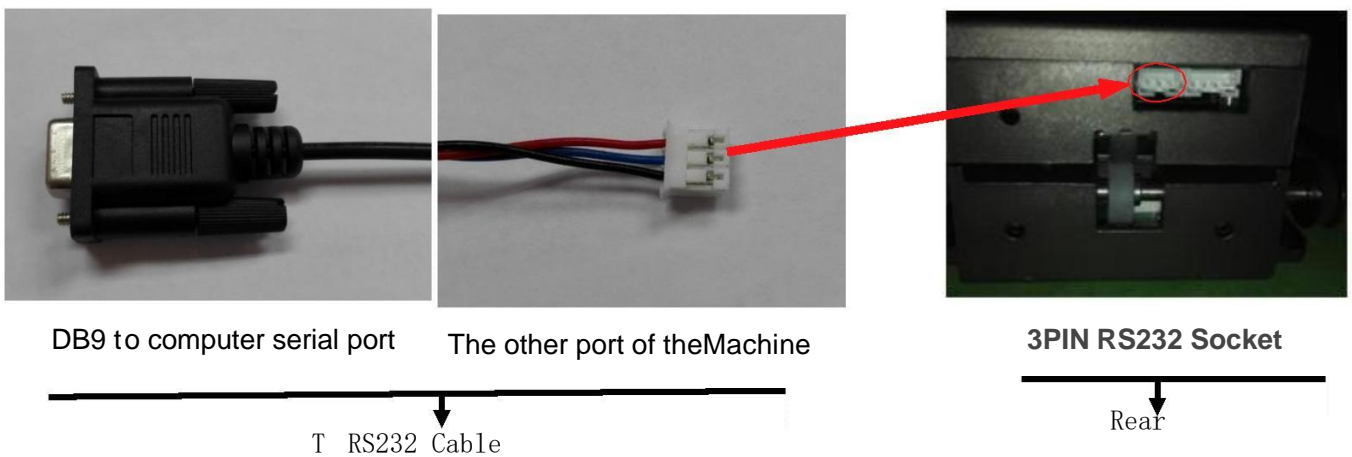

RS232-ZIP		
PIN-NO.	Input	Requirement
1Pin(Right)	TXD	RS232 level
2Pin(Middle)	RXD	RS232 level
3Pin(Left)	GND	Connect with Ground

Power supply interface

POWER CABEL



PIN-NO.	INPUT	REQUIREMENT
PIN 2&3 Black Wire	GND	Connect with Ground
PIN 1&4 Red Wire	VCC	DC12V Current over 1.5A



Power cable connector

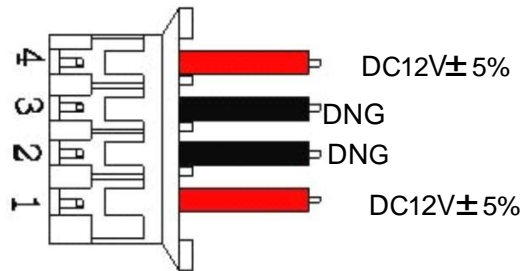

DC Power supply type

Adjustable DC Power supply



(FOR TESTING)

Constant Voltage DC Power supply



(FOR INTEGRATING AND TESTING)

Desktop AC/DC Power adaptor



(FOR TESTING)

Note: The DC Power supply is not included in the accessory list,
Before testing and integrating please prepare the power supply .

V. COMPONENTS AND PARTS INTRODUCTION

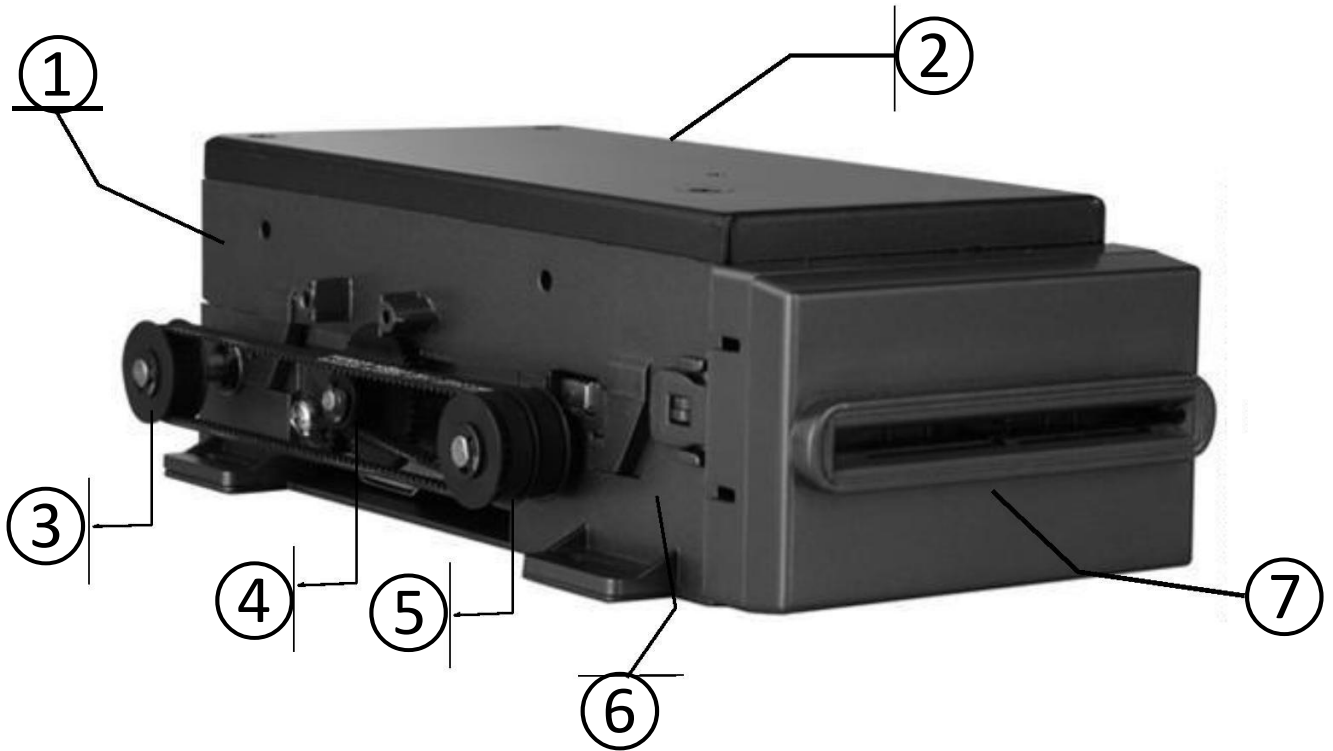

① Top Part of the Main Body

② Top Cover

③ Back transmitting wheel

④ Transmitting belt

⑤ Front transmitting wheel

⑥ Another Part of the Main Body

⑦ Card Bezel series

VI. OPERATION GUIDE

CARD INSERTION NOTE:

Magnetic card: The magnetic area under the right side of the card, as picture indicated

Contact IC card: Hold the card, the chip IC at the front of the card to insert, as picture indicated.

Non-contact IC card: Both side and direction is available for reading and writing.

※CARD INSERT DIRECTION AS BELOW

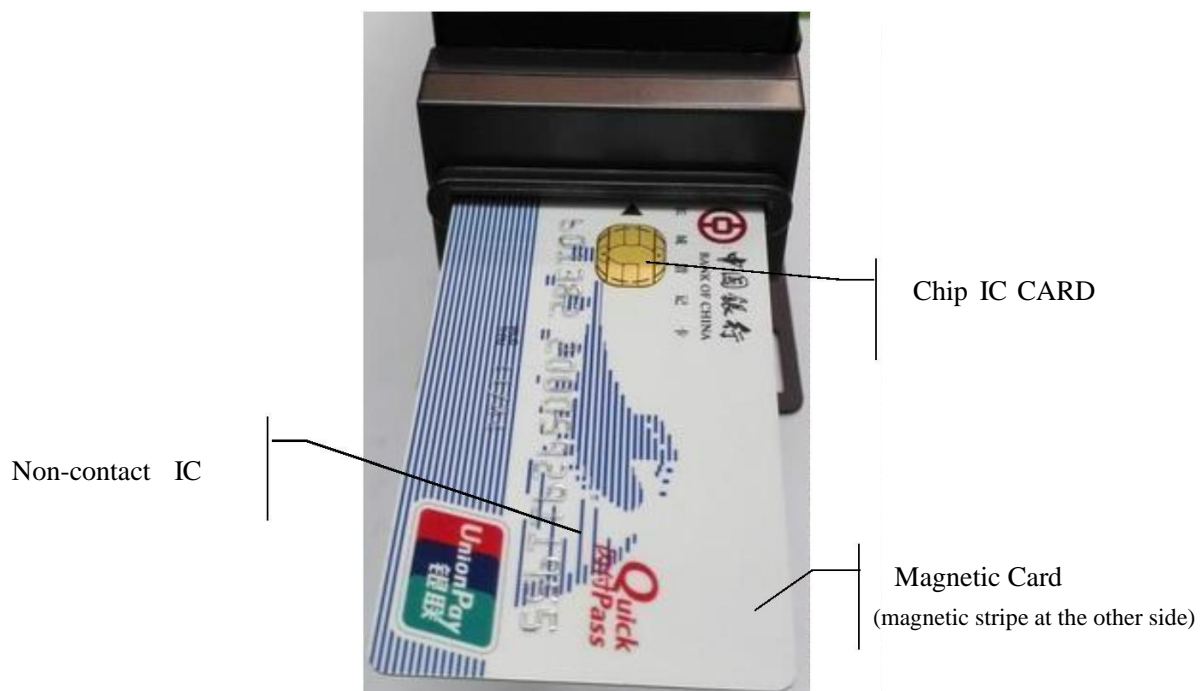

VII. INSTALLATION AND STRUCTURE DRAWING

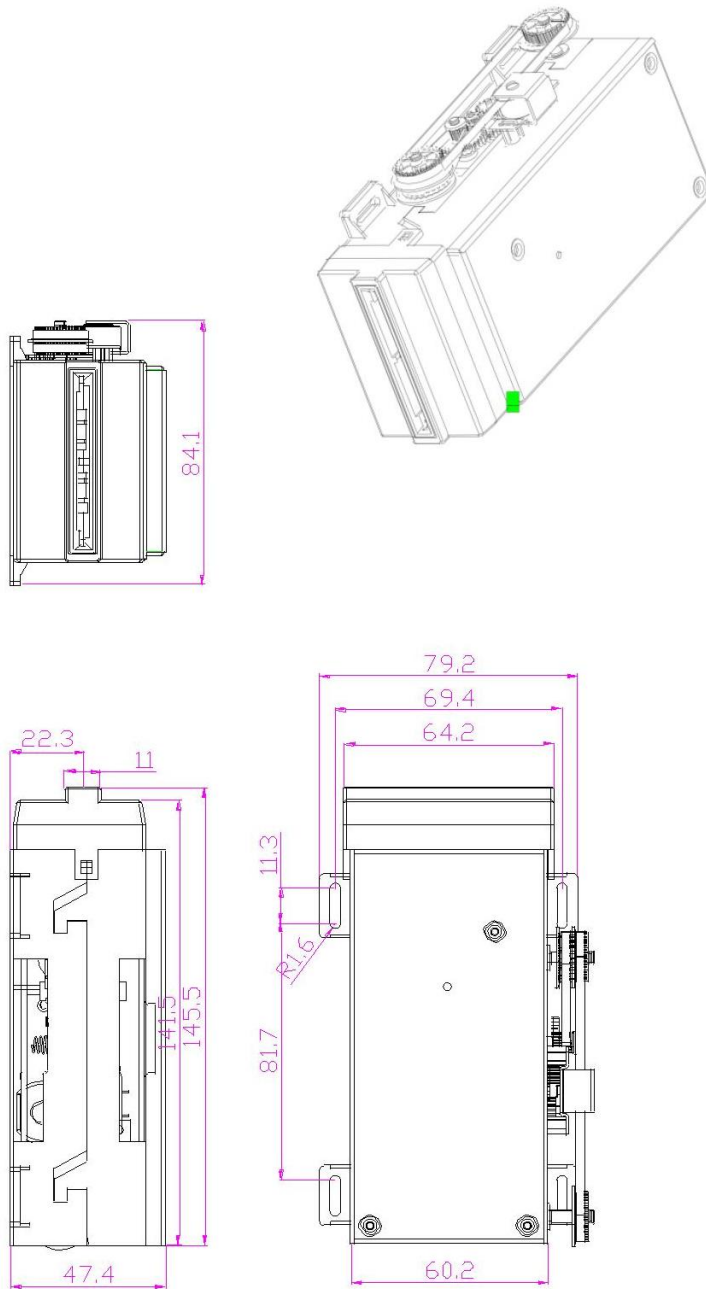

VIII. CAUTION DURING OPERATION

- 1) When connecting interface, please connect with communication interface first, then power interface. And then power on.
- 2) To make your product safe, the input voltage please not above 40V.
- 3) Please set BPS rate correct. EX-work set is 9600bps.
- 4) During operation, card insert direction should be correct
 - a) When inserting magnetic card, magnetic stripe should face down and insert on the right side.
 - b) When inserting IC card, chip should face up. If insert from the front, the end close to chip should be inserted into card reader first. If insert from the rear, the end away from chip should be inserted into card reader first.
 - c) When inserting RF card, directions are not considered. But it can only be operated at RF position.
- 5) When there is card in the machine, error message will be given if inserting card again. And motor door will not open.
- 6) When shutting off power, power interface should be shut off first, then communication interface.
- 7) Power off during operation or other abnormal reason lead to card staying in the machine and cannot be taken out, please take out card by pulling belts manually.
- 8) Disassembly method Drawing

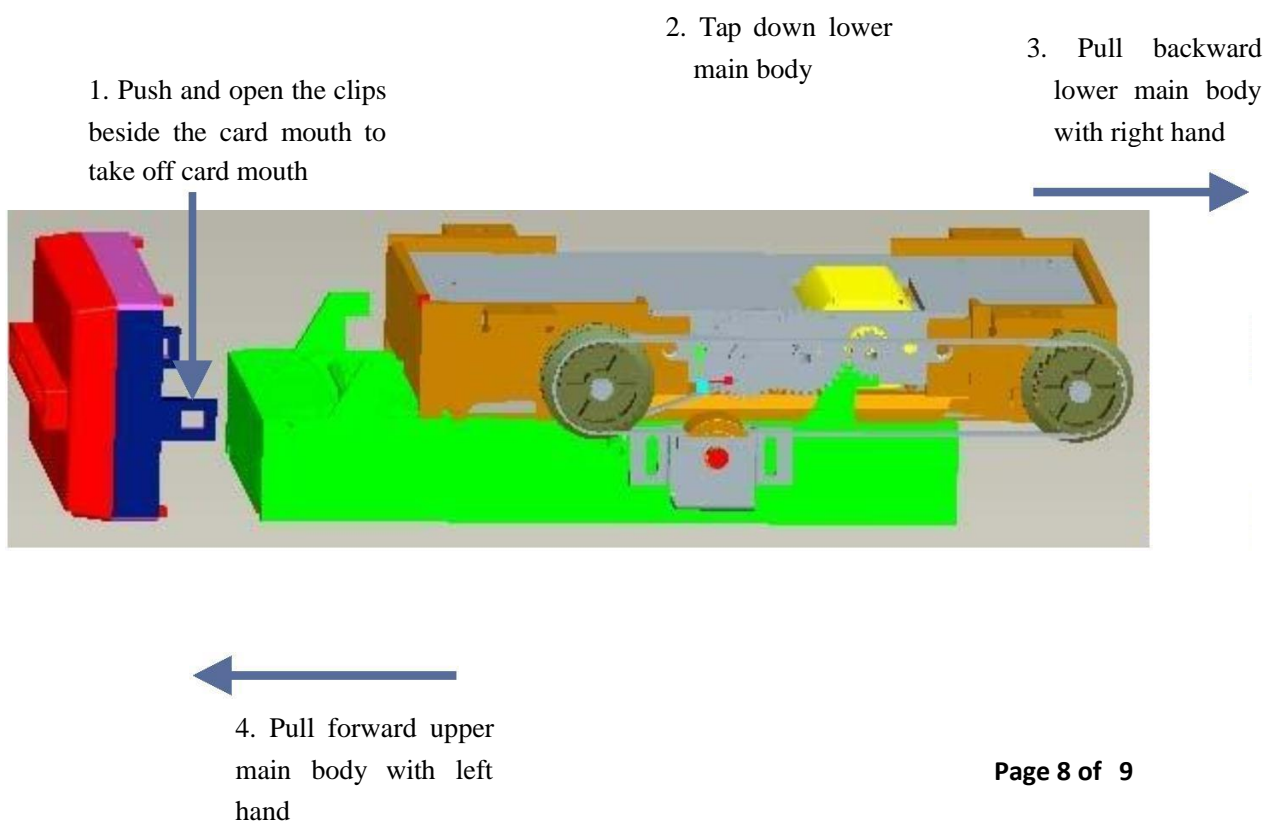

IX. Mantainace

1. Transmitter maintenance

- a) Select “Check transmitter status” in “card reader control command screen”.
- b) In normal condition, information of 5 transmitters in text box will all show “No card”.
- c) If one or several transmitters show “Have card”, maybe they are covered with dirt.
- d) Should disassembly card reader and clean it.

drawing”.

2. Magnetic head maintenance

Use cleaning card to clean magnetic head in card reader.

3. Detecting pin contact maintenance

Dirt on the detecting pin of IC card makes machine not connect well with IC card chip. You should disassembly machine to clean it. Please refer to “disassembly method drawing”.

4. Gear maintenance

Check gear periodically and clean dirt with alcohol.