

Operating Instruction for 384 x 288 Pixels Outdoor Thermal Vision Monocular



Please read this manual before switching the unit on.
Important safety information inside.

Content	Page
1.Safety Information.....	4
2.Packing lists.....	5
3.Specifications.....	6
4.Structure Description.....	7
5.Before You Start.....	8
5-1.How to Charge the Battery.....	8
5-2.Power On.....	8
5-3.Power Off.....	8
5-4.Desktop.....	9
5-5.Lens.....	9
5-6.EVF Focus.....	10
5-7.Shutter.....	10
5-8.Thermal Imager Reporter Software.....	10
6.Menus.....	11
6-1.Settings Menu.....	11
6-1-1.Device Setting.....	11
6-1-2.Camera Setting.....	14
6-1-3.Reset.....	15
6-2.Camera Menu.....	16
6-3.Video Menu.....	16
6-4.Gallery Menu.....	17
7.Fault Diagnosis and Exclusion.....	17
8.Android/iOS APP Thermview.....	17
8-1.Software install and uninstall.....	17
8-1-1.System Required.....	17
8-1-2.Thermoview App Install.....	17
8-2.Thermview Function.....	18
8-2-1.Import Pictures Through WIFI.....	18
8-2-2.Realtime IR Video Stream Through WIFI.....	18

1. Safety Information

- To prevent eye damage and personal injury, do not look into the laser, do not point laser directly at persons or animals or indirectly off reflective surfaces.
- Do not disassemble or do a modification to the Thermal Imager.
- Do not point the Thermal Imager (with or without the lens cover) at intensive energy sources, for example devices that emit laser radiation or the sun, this can have an unwanted effect on the accuracy of the camera, it can also cause damage to the detector in the Thermal Imager.
- Do not use the Thermal Imager in a temperature higher than 50°C (122°F), lower than -20°C (-4°F), High temperature or low temperature can cause damage to the Thermal Imager.
- Only use the correct equipment to discharge the battery.
- If you do not use the correct equipment, you can decrease the performance or the life cycle of the battery, If you do not use the correct equipment, an incorrect flow of current to the battery can occur, This can cause the battery to become hot, or cause an explosion and injury to persons.
- Do not pull out the battery when the thermal imager is working.
- If you pull out the battery when the thermal imager is working, it may cause the thermal imager work unnormal.
- Do not disassemble or do a modification to the battery.
- The battery contains safety and protection devices which, if they become damaged, can cause the battery to become hot, or cause an explosion or an ignition.
- If there is a leak from the battery and the fluid gets into your eyes, do not rub your eyes, Flush well with water and immediately get medical care.
- Do not make holes in the battery with objects, do not hit the battery with a hammer, do not step on the battery or apply strong impacts or shocks to it.
- Do not put the battery in or near a fire, or in direct sunlight or other high-temperature locations, do not solder directly onto the battery.
- Always charge the battery in the special temperature rang.
- The temperature range through which you can charge the battery is 0 to 50°C (32 to 122°F), If you charge the battery at temperatures out of this range, it can cause the battery to become hot or to break, It can also decrease the performance or the life cycle of the battery.
- Do not get water or salt water on the battery, or permit the battery to get wet.
- Clean the case with a damp cloth and a weak soap solution. Do not use abrasives, isopropyl alcohol or solvents to clean the case or lens/screen.
- Be careful when you clean the infrared lens, Do not clean the infrared lens too vigorously, this can damage the anti-reflective coating.

- Take the Thermal Imager from cold to hot, it will appear condensation in thermal Imager, to protect the Thermal Imager, you should power of the Thermal Imager, wait until the Thermal Imager has become warm enough for the condensation to evaporate.
- If you do not use the Thermal Imager, put the Thermal Imager in cool and dry environment, if you store Thermal Imager equipped with the battery, the power of the battery will be exhausted.

2.Packing lists

Standard Accessories

Item	Quantity	Description
Thermal Imager	1	
Lens	1	Field of View = 19.6x14.7°, f=19mm
Li-ion Battery	1	3.7V, 2800mAh
AC Adaptor	1	Input AC Volts: 100V~240V 50/60Hz MAX 0.6 A Output DC Volts: 5V MAX 3.0A
USB Cable	1	
Non-Slip Strap	1	
User Manual	1	
Warranty Card	1	
Protective Bag	1	

Optional Accessories

Item	Quantity	Description
Multiplying Len	1	Field of View=10.6x8°, f=35mm

3. Specifications

Imaging and Optical Data

Field of View (FOV)	19.6 x 14.7°
Minimum Focus Distance	2m
IR Resolution	384 x 288 Pixels
Image Frequency	50Hz
Focal Length	19mm
Spatial Resolution (IFOV)	0.89mrad
Focus Mode	Focus Free
Zoom	1-32x continuous, digital zoom
Focal Plane Array (FPA)	Uncooled microbolometer
Spectral Range	8-14 μ m

Image Presentation

Display	1.44 in, EVF, 640x480 Pixels
Color Palettes	Iron/Grey/Grey Invert/Red Hot/Blue Cold

Storage of Videos

Storage Media	3.4GB internal EMMC
Video Storage Format	Standard MPEG-4 encode, 640x480 at 30fps

Storage of Images

Image Storage Format	Standard JPEG
----------------------	---------------

Data Communication Interfaces

Interfaces	USB-mini
USB	Data transform between camera and PC
WiFi	802.11, transfer images and realtime video stream

Power System

Battery	Li-ion battery, 4 hours operating time
Input Voltage	DC 5V
Charging System	In camera (AC adapter)
Power Management	Automatic shutdown

Environmental Data

Operating Temperature Range	-20 to 50°C (-4 to 122°F)
Storage Temperature Range	-40 to 70°C (-40 to 158°F)
Humidity (Operating and Storage)	10%~90% Humidity

Drop Test	2m
Bump	25g(IEC60068-2-29)
Vibration	2g(IEC60068-2-6)

Physical Data

Camera Weight, Incl. Battery	<500g
Camera Size (LxWxH)	171 x 47 x 57mm

4. Structure Description

- | | |
|-----------------------|------------------------------|
| 1-Infrared Len | 7-Down/Zoom Out Button |
| 2-EVF LCD Display | 8-EVF Lcd Len Forcus Ring |
| 3-Micro USB/Charge | 9-Power/Charge Indicator |
| 4-Power/Return Button | 10-Infrared Len Cover |
| 5-Up/Zoom in Button | 11-Hole for Tripod Insertion |
| 6-Menu/Capture Button | 12-Non-slip Strap |

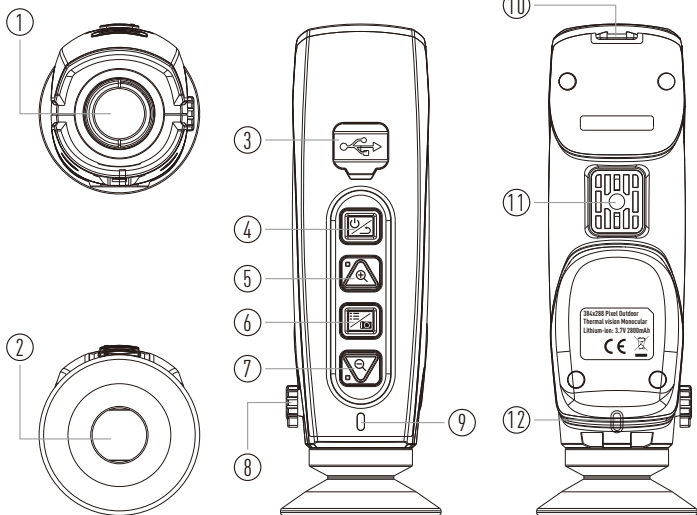

5. Before You Start

5-1. How to Charge the Battery

- Before you use the Thermal Imager for the first time, charge the battery for three and three-half hours.
- The battery status shows on the six-segment charge indicator.
- To charge the battery, use follow before:
 1. Connect the ac power adapter into an ac wall outlet and connect the dc output to the Thermal Imager's ac power socket, the charge light is on, The battery indicator becomes "🔋 → 🔋 → 🔋 → 🔋 → 🔋 → 🔋" while the battery charges with the ac power adapter.
 2. Charge until the charge indicator becomes "🔋", the charge icon not changed.
 3. Disconnect ac power adapter when the battery is full charged.

Note: Make sure that the Thermal Imager is near room temperature before you connect it to the charger. Do not charge in hot or cold areas. When you charge in extreme temperature, battery capacity may be decreased.

5-2. Power On

To turn the Thermal Imager on, push the **Power/Return** Button.

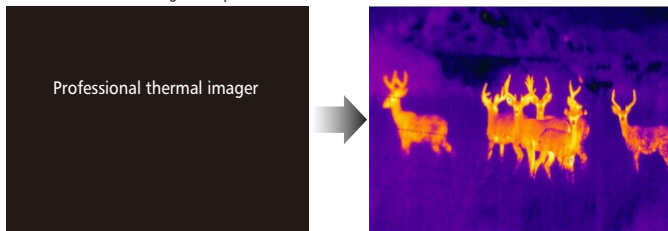

5-3. Power Off

When Thermal Imagers power on, Push and hold the **Power/Return** Button for two seconds, then the device will be forced power off directly.

5-4.Desktop

The Desktop is as follow:

- 1-Time
- 2-Zoom
- 3-Setting Menu
- 4-Centre Point Cross
- 5-Wifi on Status
- 6-Battery Capacity Status

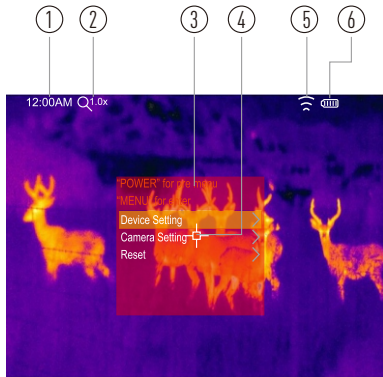

5-5.Lens

- The Thermal Imager has a Lens.
- **FOV** is the largest area that your imager can see at a set distance.
- This table lists the horizontal FOV, vertical FOV and IFOV for lens.

Focal Length	Horizontal FOV	Vertical FOV	IFOV
19mm	19.6°	14.7°	0.89mrad

- **IFOV** (Instantaneous Field of View) is the smallest detail within the FOV that can be detected or seen at a set distance, the unit is rad, The formula is this: **IFOV=(Pixel Size)/(Lens focal length)**.
- D:S theoretical (=1/IFOV theoretical) is the calculated spot size based on the pixel size of the Thermal Imager detector array and lens focal length.

Example: If Thermal Imager uses 19mm lens, because the Pixel Size of detector is 17 μ m, Horizontal FOV is 19.6°, Vertical FOV is 14.7°, the IFOV is 17 μ m/19mm=0.89mrad; D:S theoretical (=1/ IFOV theoretical)=1123:1.

- D:Smeasure (=1/IFOV measure) is the spot size needed to provide an accurate temperature measure.
- Typically D:S measure is 2 to 3 times smaller than D:S theoretical, which means the temperature measurement area of the target need to be 2 to 3 times larger than that determined by the calculated theoretical D:S.

Note: IFOV theoretical represents the smallest objects that the thermal imager can detect or see. IFOV measure represents the smallest object form which an accurate temperature can be measured by the thermal imager.

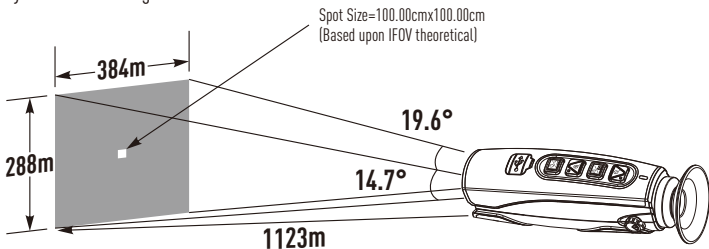

5-6.EVF Focus

- To adjust focus, clockwise or Anti-clockwise rotates the EVF display button.
- When target comes into focus, it shows a sharper image.
- When the target moves out of focus, the thermal image becomes blurry.



Focus to get
clear image



5-7.Shutter

- The thermal image of the thermal imager becomes blurry, when the thermal imager no correcting after some minutes or the thermal imager changes target.
- To get fine thermal image, the thermal imager need to correct.

5-8.Thermal Imager Reporter Software

- Thermal imager reporter software is supplied with the thermal imager.
- This software is intended for thermal imager and contains feature to analyze images, organize data and information, and make professional reports.

6. Menus

The menus, together with buttons, are access for image, measurement, Emiss, Palette, temperature measurement range, take photo and video, review, and settings.

6-1. Settings Menu

Long press the **Menu/Capture** Button, the Settings menu will display.

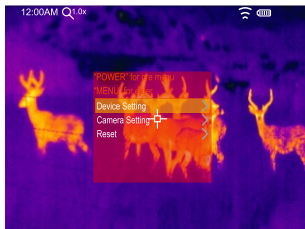

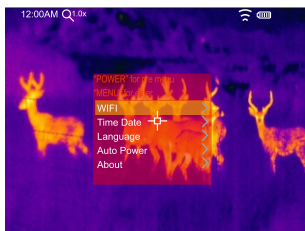

6-1-1. Device Setting

There are multipages in Device setting, use “∨” icon to go to next page or use “∧” to go to previous page.



WIFI

- Press “ → ” to turn on the wifi, the wifi model worked on Access Mode, so it is need to set the SSID and Password to allow other device connect to it.
- The default SSID is “xxxx”, the default password is “12345678”.

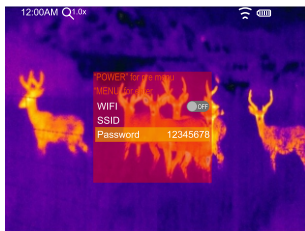

- You can modify the default wifi ssid and password.

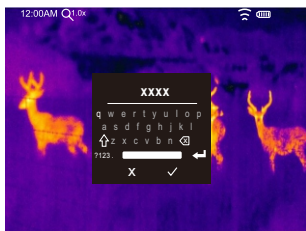

Set WIFI SSID

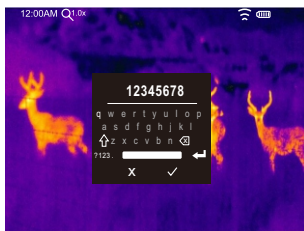

Set WIFI Password

Time Date

- Press “” or “” to select Time/Date item.

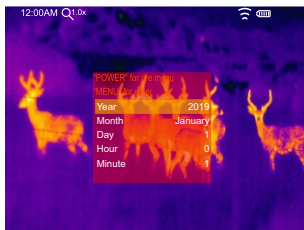

- Press “ \wedge ” or “ \vee ” to change the value, press **Menu/Capture** Button to save the change, press **Power/Return** Button to quit.

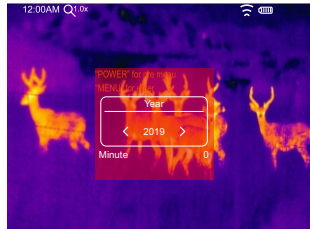

Language

Press **UP/DOWN** Button to to select language and use **Menu/Capture** Button to set selected language to be valid.

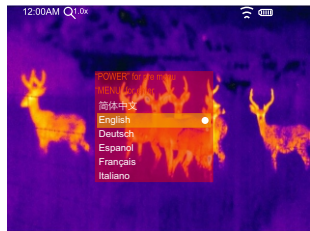

Auto Power Off

- There are four options in auto power off menu, as follows: “OFF”, “5Min”, “10Min”, “15Min”, “30Min”.
- When press the keyboard, the timer of Auto Power Off will be cleared and re-timed.

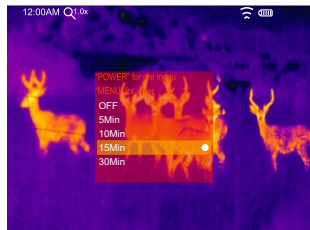

Info

The info menu contains all of the product information, such as: software version, serial number and so on.

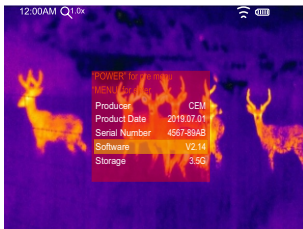

6-1-2.Camera Setting

There are three options in Camera setting menu, as follow picture.

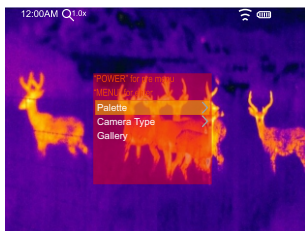

Palette

- The Image Palette lets you change the false-color presentation of the infrared images on display or captured.
- A variety of palettes are available for specific applications.
- The standard palettes offer an equal, linear presentation of colors that allow for best presentation of detail.

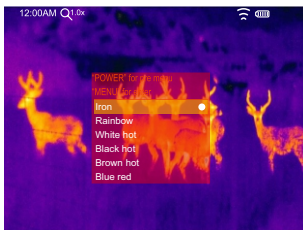

Camera Type

There are two options in camera type menu, "Photo" for taking photo, "Video" for taking video.

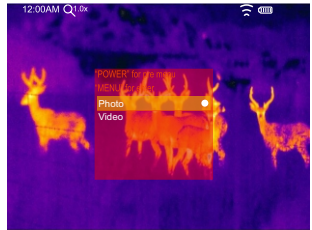

Gallery

Press "MENU" button, will goto gallery.

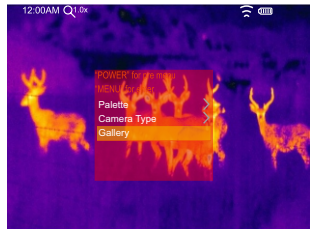

6-1-3.Reset

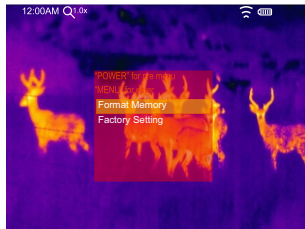

Format Memory

Format Memory operation will format all the Picture Gallery, the device setting is not affected.

Factory Settings

Factory Settings of the Thermal Imager is as follow:

Item	Parameter	Value
Image	Palette	Iron
System Setting	Language	English

6-2.Camera Menu

- Thermal Imager has photo and video functions.
- In photo function, the Imager can save thousands of images.
- Every image resolution is 1280x960, format is .jpg, and stores infrared data and visible data in an image.
- In video function, the Imager has .mp4 video capture for hours, and save infrared data in .mp4 format.

Note: Images and video files are stored in SD Memory Card. Images can easily be read and second analyzed within Thermal Imager PC software.

Save Image

- 1.Camera type must be "PHOTO".
- 2.In desktop, press **MENU** Button, then will take a photo immediately.

6-3.Video Menu

The Thermal Imager has .mp4 video capture.

- 1.Camera type must be "VIDEO".
- 2.In desktop, press **MENU** Button, start video capture with voice.
- 3.To stop video capture, press **MENU** Button again.
- 4.The video saved in the video file.

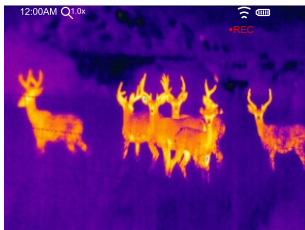

6-4. Gallery Menu

1. Pres **"UP"/"DOWN"** Button to select prev/next photo or video.
2. When current file type is video, press **MENU** Button, will start or stop the video play.

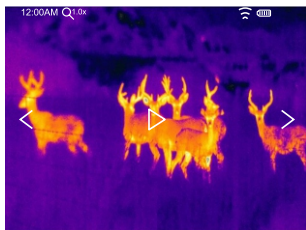

7. Fault Diagnosis and Exclusion

- If you encounter any problems while using the thermal imager, overhaul according to the following table.
- If the problem persists, disconnect the power and contact with the company's technical support department.

Phenomenon of the Fault	Cause of the Fault	Solution
Thermal Imager Cannot Start	No Battery	Inserting the battery
	No Power	Replace the battery or charge it
Thermal Imager Shut Down	No Power	Replace the battery or charge it
No Thermal Image	The Lens Cap Cover	Opened the lens cap

8. Android/iOS APP Thermview

8-1. Software install and uninstall

8-1-1. System Required

Android mobile phone: Android 4.0 above, with USB OTG Support

iOS: iPhone4 above

8-1-2. Thermview App Install

Android: Search "Thermview" on Google Play and install it.

iOS: Search "Thermview" on Apple Store and install it.

8-2. Thermview Function

8-2-1.Import Pictures Through WIFI

- 1.Open the wifi function on the thermal imager.
- 2.Connect the smart device to the thermal imager
- 3.Downlaod the image from the thermal imager.

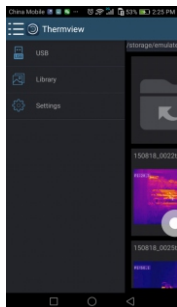

8-2-2.Realtime IR Video Stream Through WIFI

- 1.Open the wifi function on the thermal imager.
- 2.Connect the smart device to the thermal imager
- 3.Get the Realtime video stream from the thermal imager



