

Reflective/Terminal Type with Visible Light Cut Filter (Standard Sensing Distance = 5 mm)

- Dust resistant structure
- Type with screw mounted tab (M3)

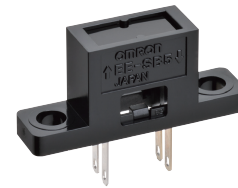

⚠ Be sure to read *Safety Precautions* on Page 3.

RoHS Compliant

Ordering Information

Photomicrosensor

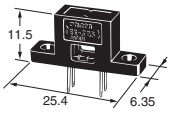
Appearance	Sensing method	Connecting method	Standard sensing distance	Output type	Model	Minimum packing unit (Unit: pcs)
	Reflective	Terminal for cord soldering	5 mm	Phototransistor	EE-SB5	1

Note: Order in multiples of minimum packing unit.

Ratings, Characteristics and Exterior Specifications

Absolute Maximum Ratings (Ta = 25°C)

Item	Symbol	Rated value	Unit
Emitter			
Forward current	I_F	50*1	mA
Pulse forward current	I_{FP}	1*2	A
Reverse voltage	V_R	4	V
Detector			
Collector-Emitter voltage	V_{CEO}	30	V
Emitter-Collector voltage	V_{ECO}	—	V
Collector current	I_C	20	mA
Collector dissipation	P_C	100*1	mW
Operating temperature	T_{opr}	-25 to 80	°C
Storage temperature	T_{stg}	-30 to 80	°C
Soldering temperature	T_{sol}	260*3	°C

*1. Refer to the temperature rating chart if the ambient temperature exceeds 25°C.

*2. Pulse width $\leq 10 \mu s$, Repeated 100 Hz

*3. Complete soldering within 10 seconds.

Exterior Specifications

Connecting method	Weight (g)	Material
		Case
Terminal for cord soldering	1	Polycarbonate

Electrical and Optical Characteristics (Ta = 25°C)

Item	Symbol	Value			Unit	Condition
		MIN.	TYP.	MAX.		
Emitter						
Forward voltage	V_F	—	1.2	1.5	V	$I_F = 30 \text{ mA}$
Reverse current	I_R	—	0.01	10	μA	$V_R = 4 \text{ V}$
Peak emission wavelength	λ_P	—	940	—	nm	$I_F = 20 \text{ mA}$
Detector						
Light current	I_L	200	—	2000	μA	$I_F = 20 \text{ mA}$, $V_{CE} = 10 \text{ V}$ Reflectance 90% White paper $d = 5 \text{ mm}^*$
Dark current	I_D	—	2	200	nA	$V_{CE} = 10 \text{ V}$, 0 lx
Leakage current	I_{LEAK}	—	—	2	μA	$I_F = 20 \text{ mA}$, $V_{CE} = 10 \text{ V}$ Non-reflective state
Collector-Emitter saturated voltage	$V_{CE(sat)}$	—	—	—	V	—
Peak spectral sensitivity wavelength	λ_P	—	850	—	nm	$V_{CE} = 10 \text{ V}$
Rising time	t_r	—	30	—	μs	$V_{CC} = 5 \text{ V}$, $R_L = 1 \text{ k}\Omega$ $I_L = 1 \text{ mA}$
Falling time	t_f	—	30	—	μs	$V_{CC} = 5 \text{ V}$, $R_L = 1 \text{ k}\Omega$ $I_L = 1 \text{ mA}$

* "d" is the distance from the top of the sensor to the reflective surface

Engineering Data (Reference Value)

Fig 1. Forward Current vs. Collector Dissipation Temperature Rating

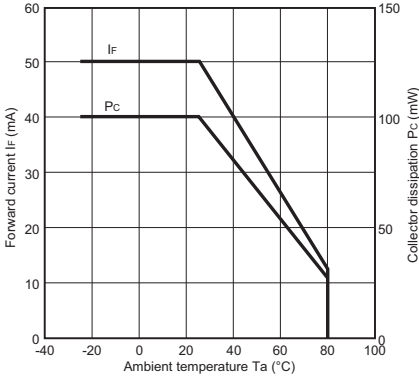

Fig 2. Light Current vs. Forward Current Characteristics (Typical)

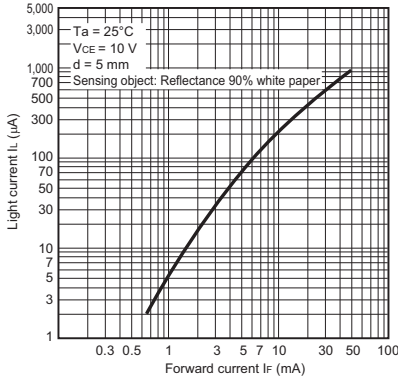

Fig 3. Light Current vs. Collector-Emitter Voltage Characteristics (Typical)

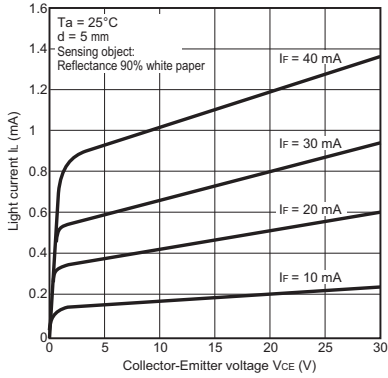

Fig 4. Relative Light Current vs. Ambient Temperature Characteristics (Typical)

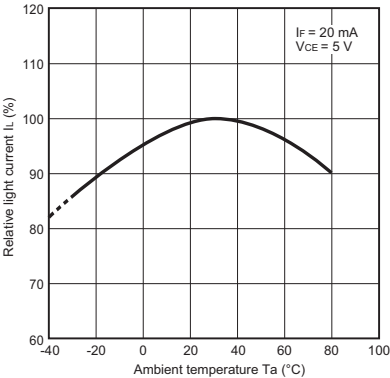

Fig 5. Dark Current vs. Ambient Temperature Characteristics (Typical)

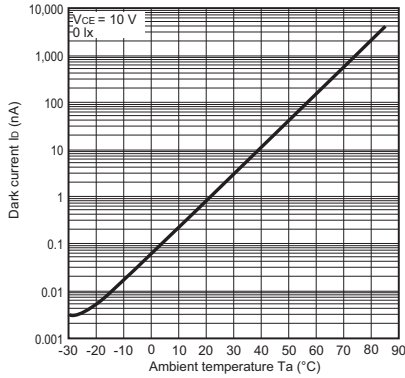

Fig 6. Response Time vs. Load Resistance Characteristics (Typical)

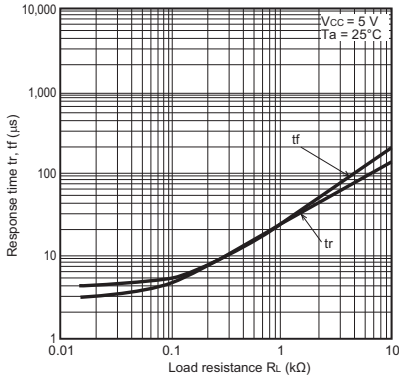

Fig 7. Sensing Distance Characteristics (Typical)

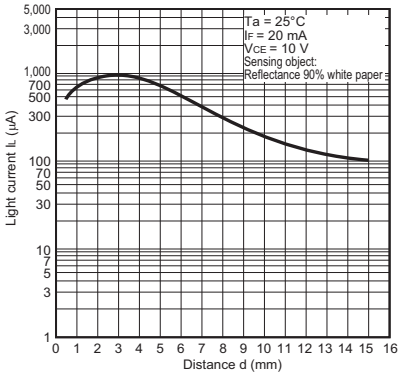

Fig 8. Sensing Position Characteristics (Typical)

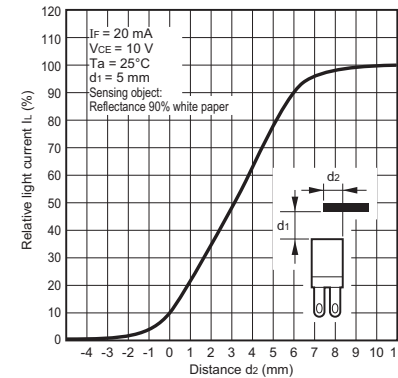

Fig 9. Sensing Position Characteristics (Typical)

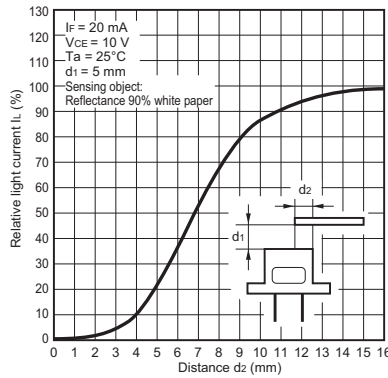

Fig 10. Sensing Angle Characteristics (Typical)

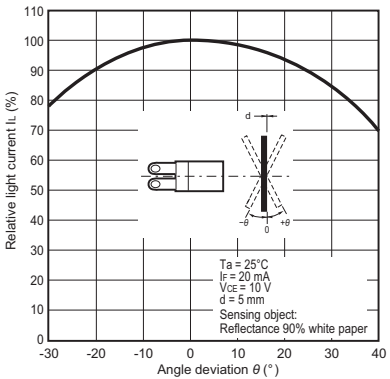
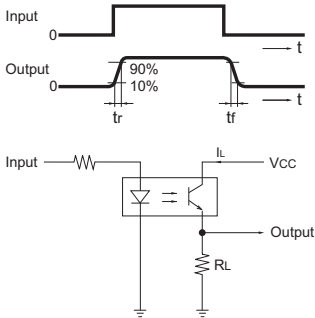

Fig 11. Response Time Measurement Circuit



Safety Precautions

To ensure safe operation, be sure to read and follow the Instruction Manual provided with the Sensor.

CAUTION

This product is not designed or rated for ensuring safety of persons either directly or indirectly. Do not use it for such purposes.



Precautions for Correct Use

Do not use the product in atmospheres or environments that exceed product ratings.

Precautions for Safe Use

Do not use the product with a voltage or current that exceeds the rated range.

Applying a voltage or current that is higher than the rated range may result in explosion or fire.

Do not miswire such as the polarity of the power supply voltage.

Otherwise the product may be damaged or it may burn.

This product does not resist water. Do not use the product in places where water or oil may be sprayed onto the product.

Dimensions and Internal Circuit

(Unit: mm)

Photomicrosensor

EE-SB5

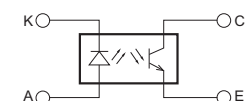
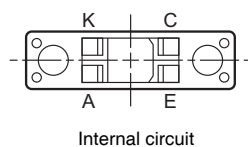
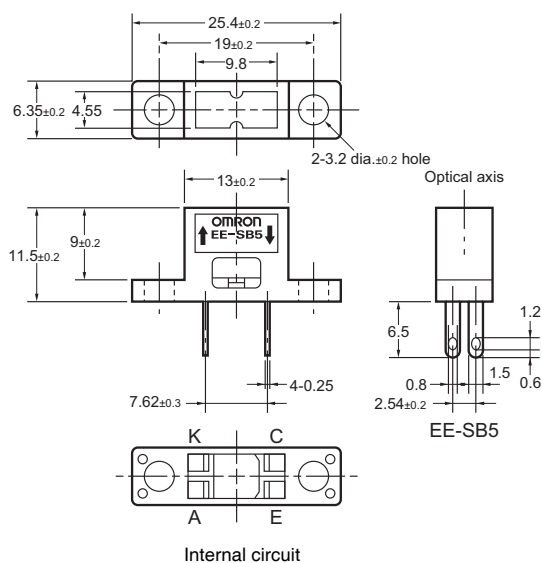

Terminal No.	Name
A	Anode
K	Cathode
C	Collector
E	Emitter

Unless otherwise specified, the tolerances are as shown below.

Dimensions	Tolerance
3 mm max.	±0.3
3 < mm ≤ 6	±0.375
6 < mm ≤ 10	±0.45
10 < mm ≤ 18	±0.55
18 < mm ≤ 30	±0.65

Please check each region's Terms & Conditions by region website.

OMRON Corporation

Electronic and Mechanical Components Company

Regional Contact

Americas

<https://www.components.omron.com/>

Asia-Pacific

<https://ecb.omron.com.sg/>

Korea

<https://www.omron-ecb.co.kr/>

Europe

<http://components.omron.eu/>

China

<https://www.ecb.omron.com.cn/>

Japan

<https://www.omron.co.jp/ecb/>