

A thick black line starts from the left edge, goes down vertically, then diagonally up and to the right, and then continues horizontally to the right edge.

***VOLTcraft***

Ⓒ Operating Instructions

## **WS-PS2001 Portable Power Station 2000 W**

Item no: 2619335

**CE**

# Table of Contents

1	Introduction .....	4
2	Intended use .....	4
3	Delivery contents .....	4
4	Latest product information .....	4
5	Description of symbols .....	5
6	Safety instructions .....	5
6.1	General .....	5
6.2	Handling .....	5
6.3	Operating environment .....	5
6.4	Charging .....	6
6.5	Operation .....	6
6.6	Mains cable .....	6
6.7	LED light .....	7
6.8	Connected devices .....	7
7	Product overview .....	8
7.1	Front view .....	8
7.2	Side views .....	9
7.3	Display .....	10
8	Getting started .....	11
8.1	Switching on/off .....	11
8.2	Using the light .....	11
9	Charging product battery (Input) .....	12
9.1	Charging via mains supply (230 V/AC) .....	12
9.2	Charging via solar panel .....	12
9.3	Charging via road vehicle (12/24 V/DC) .....	13
10	Powering devices (Output) .....	14
10.1	Connecting devices .....	14
10.2	Powering devices .....	14
11	Using as UPS (uninterruptible power supply) .....	15
12	Configuring parameters .....	16
12.1	Configuring AC output voltage (220/230 V/AC) .....	16
12.2	Configuring AC output voltage frequency (50/60 Hz) .....	16
13	Troubleshooting .....	17
14	Cleaning .....	18
15	Storage .....	18
16	Disposal .....	18

17 Technical data ..... 19

17.1 Rechargeable battery ..... 19

17.2 Output power ..... 19

17.3 Protection ..... 19

17.4 UPS (Uninterruptable power supply) ..... 19

17.5 Input ..... 20

17.6 DC Output ..... 20

17.7 AC output ..... 21

17.8 Light ..... 21

17.9 Operating and storage environment ..... 22

17.10 Others ..... 22

# 1 Introduction

Dear customer,

Thank you for purchasing this product.

If there are any technical questions, please contact:

[www.conrad.com/contact](http://www.conrad.com/contact)

## 2 Intended use

The product is a portable rechargeable power station. Use the product:

- to power mains-powered appliances (230 V/AC)
- to power DC-powered devices
- as an uninterruptible power supply (UPS)

The product is equipped with the following protection mechanism:

- Input protection to protect against overvoltage
- Output protection to protect against port overloading
- High/low temperature protection
- Protection against short circuiting

The product is intended for indoor use only. Do not use it outdoors.

Contact with moisture must be avoided under all circumstances.

If you use the product for purposes other than those described, the product may be damaged.

Improper use can result in short circuits, fires, electric shocks or other hazards.

The product complies with the statutory national and European requirements.

For safety and approval purposes, you must not rebuild and/or modify the product.

Read the operating instructions carefully and store them in a safe place. Make this product available to third parties only together with the operating instructions.

All company names and product names are trademarks of their respective owners. All rights reserved.

USB4®, USB Type-C® and USB-C® are registered trademarks of USB Implementers Forum.

## 3 Delivery contents

- Power station
- Mains cable
- Operating instructions

## 4 Latest product information

Download the latest product information at [www.conrad.com/downloads](http://www.conrad.com/downloads) or scan the QR code shown. Follow the instructions on the website.

## 5 Description of symbols

The following symbols are on the product/appliance or are used in the text:



The symbol warns of hazards that can lead to personal injury.



The symbol warns of dangerous voltage that can lead to personal injury by electric shock.



This product must only be used in dry, enclosed indoor areas. It must not become damp or wet.



Read the operating instructions carefully.

## 6 Safety instructions



**Read the operating instructions carefully and especially observe the safety information. If you do not follow the safety instructions and information on proper handling, we assume no liability for any resulting personal injury or damage to property. Such cases will invalidate the warranty/guarantee.**

### 6.1 General

- The product is not a toy. Keep it out of the reach of children and pets.
- Do not leave packaging material lying around carelessly. This may become dangerous playing material for children.
- If you have questions which remain unanswered by this information product, contact our technical support service or other technical personnel.
- Maintenance, modifications and repairs must only be completed by a technician or an authorised repair centre.

### 6.2 Handling

- Handle the product carefully. Jolts, impacts or a fall even from a low height can damage the product.

### 6.3 Operating environment

- The product can only operate in limited temperature and humidity ranges. Always observe the temperature and humidity ranges in the technical data to prevent fire or explosion.
- Radio frequencies can make the product malfunction and cause fire, explosion, or accidents. Operate the product away from strong radio frequencies.
- The product can catch fire or explode if exposed to high temperatures. Keep the product away from heat sources such as open fires and stoves. Do not place inside a vehicle or other closed object that is exposed to the sun.
- Do not switch the product on after it has been taken from a cold to a warm environment. The condensation that forms might destroy the product. Allow the product to reach room temperature before you use it.
- Do not place the product under any mechanical stress.
- Protect the appliance from extreme temperatures, strong jolts, flammable gases, steam and solvents.

- Protect the product from high humidity and moisture.
- Protect the product from direct sunlight.

## 6.4 Charging

- You are strongly advised to attend the product while it is being charged. In case of malfunction, immediately disconnect the power supply to the product.
- The product battery heats up during product use and can explode or catch fire if charged immediately after use. Let the product cool down to room temperature before you charge it.

## 6.5 Operation

- Do not sit or stand on the product.
- Do not place objects onto the product.
- Do not connect defective cables.
- The product generates heat during use that is dissipated through the cooling system. If heat cannot be dissipated, the product could catch fire or the battery explode. NEVER cover the product or obstruct the components of the cooling system (example: fans, cooling fins, ventilation slots).
- Excessive heat (example: open fire, direct sunlight) can cause the product to catch fire. In case of fire, use a suitable fire extinguisher to extinguish the fire. Do not use the product again.
- Water can lead to electric shock. Keep the product away from water and liquids. Dry plugs before connecting. If the product falls into water, (1) disconnect the power supply cable at the power source (not at the product), (2) lift the product out of the water, and (3) let it completely dry. Do not use the product again.
- Dirt can lead to short circuiting. Keep plugs and sockets clean. Clean plugs before connecting.
- Consult an expert when in doubt about the operation, safety or connection of the product.
- If it is no longer possible to operate the product safely, take it out of operation and protect it from any accidental use. DO NOT attempt to repair the product yourself. Safe operation can no longer be guaranteed if the product:
  - is visibly damaged,
  - is no longer working properly,
  - has been stored for extended periods in poor ambient conditions or
  - has been subjected to any serious transport-related stresses.

## 6.6 Mains cable



Do not modify or repair mains supply components including mains plugs, mains cables, and power supplies. Do not use damaged components. Risk of death by electric shock!

- The mains outlet must be located near to the device and be easily accessible.
- Never plug in or unplug the mains plug when your hands are wet.
- Never pull the mains plug from the socket by pulling at the cable. Always pull it from the mains socket using the intended grips.
- Unplug the mains plug from the mains socket if you do not use the device for an extended period of time.
- Disconnect the mains plug from the mains socket in thunderstorms for reasons of safety.
- Make sure that the mains cable is not squeezed, bent, damaged by sharp edges or put under mechanical stress.
- Avoid excessive thermal stress on the mains cable from extreme heat or cold.
- Do not modify the mains cable. Otherwise the mains cable may be damaged. A damaged mains cable can cause a deadly electric shock.

- Do not touch the mains cable if it is damaged.
  - First, power down the respective mains socket (e.g. via the respective circuit breaker) and then carefully pull the mains plug from the mains socket.
  - Never use the product if the mains cable is damaged.
- A damaged mains cable may only be replaced by the manufacturer, a workshop commissioned by the manufacturer or a similarly qualified person, so as to prevent any danger.
- Ensure that cables are not pinched, kinked or damaged by sharp edges.
- Always lay cables so that nobody can trip over or become entangled in them. This poses a risk of injury.

## **6.7 LED light**

- Do not look directly into the LED light!
- Do not look into the beam directly or with optical instruments!

## **6.8 Connected devices**

- Also observe the safety and operating instructions of any other devices which are connected to the product.

# 7 Product overview

## 7.1 Front view

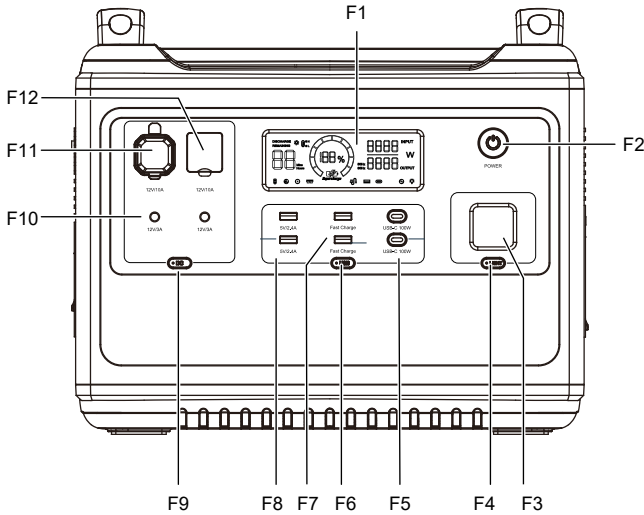

	Component	Function/Description
F1	Display	
F2	Power button <b>POWER</b>	Press and hold for 3s to switch on. Press and hold for 3s to switch off.
F3	Light	Light with light modes: solid, SOS, flashing, off
F4	Light button <b>LIGHT</b>	Press to switch light on. Press to change light modes.
F5	USB-C® output port <b>USB-C 100W</b>	Connect and power USB devices that support Power Delivery (PD)
F6	USB output activation button <b>USB</b>	Press to activate USB output ports. Press to deactivate USB output ports.
F7	USB-A output port <b>Fast Charge</b>	Connect and power USB devices that support Fast Charging.
F8	USB-A output port <b>5V/2.4A</b>	Connect and power USB devices.
F9	DC output activation button <b>DC</b>	Press to activate DC output ports. Press to deactivate DC output ports.
F10	Barrel DC output port <b>12V/3A</b>	Connect and power DC devices via barrel jack.



	Component	Function/Description
F11	Cigarette lighter output port <b>12V/10A</b>	Connect and power devices via cigarette lighter cable.
F12	XT60 output port <b>12V/10A</b>	Connect and power DC devices via XT60 connector. <b>WARNING! No built-in balancer. Risk of explosion! Do not connect rechargeable batteries.</b>

## 7.2 Side views

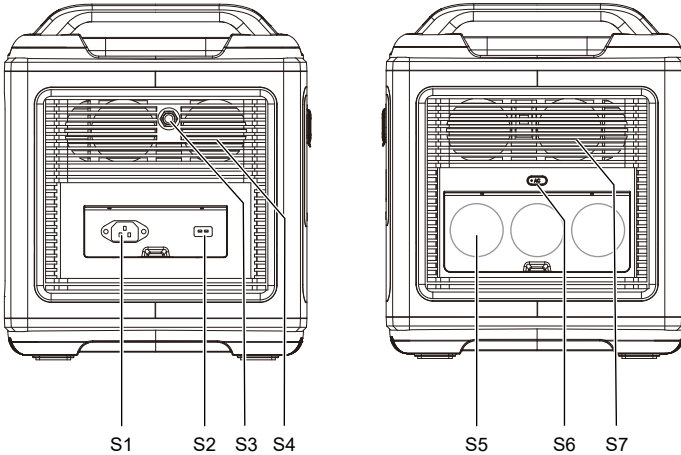

	Component	Function/Description
S1	Mains input socket	Connect mains cable to charge product battery.
S2	Anderson input port	Connect to solar panel to charge product battery. Connect to road vehicle to charge product battery (example: car).
S3	Input overload protection reset button	Press to reset after input overload protection has been triggered.
S4	Cooling fans	
S5	AC output socket	Connect and power mains appliances.
S6	AC output activation button <b>AC</b>	Press to activate mains output ports. Press to deactivate mains output ports.
S7	Cooling fans	

## 7.3 Display

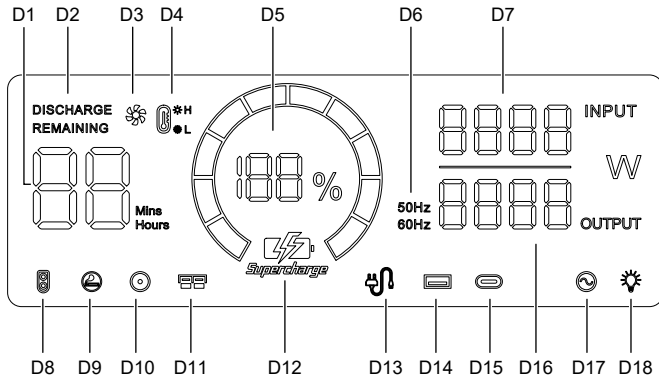

	Component	Description
D1	Remaining time indicator	Remaining charging time or remaining discharging time.
D2	Charging indicator Discharging indicator	Indicates if the product battery is being charged or discharged.
D3	Fan status indicator	Lights up if cooling fans run.
D4	High/low temperature indicator	Lights up if the temperature is too low or too high. Product will stop operating.
D5	Remaining battery charge indicator	
D6	AC output voltage frequency	
D7	Input power	
D8	XT60 output port indicator	Lights up if DC output is activated.
D9	Cigarette lighter output port indicator	Lights up if DC output is activated.
D10	Barrel DC output port indicator	Lights up if DC output is activated.
D11	Anderson input port indicator	Lights up while the product battery is being charged via Anderson input port.
D12	Supercharge indicator	Lights up while the product battery is being charged via mains supply.
D13	Mains supply charging indicator	Lights up while the product battery is being charged via mains supply.
D14	USB output indicator	Lights up if USB output is activated.
D15	USB-C® output indicator	Lights up if a device is connected to a USB-C® output port.
D16	Output power consumption	Indicates the total power consumption of all connected devices
D17	AC output indicator	Lights up if AC output is activated.

	Component	Description
D18	Light indicator	Lights up if the light is activated.

## 8 Getting started

### 8.1 Switching on/off

You can switch the product on and off manually via the power button.

**Notes:**

- You cannot switch the product off while the product battery is being charged.
- If the product is on stand-by, it will switch off automatically after a short period of time.

1. Press and hold the power button for 3 seconds to switch the product on.  
→ The display will light up.
2. Press and hold the power button for 3 seconds to switch the product off.

### 8.2 Using the light

1. Press and hold the power button for 3 seconds to switch the product on.
2. Repeatedly press the light button to switch through different light modes: SOS → flashing → off.

## 9 Charging product battery (Input)

### 9.1 Charging via mains supply (230 V/AC)

The most efficient way to charge the product battery is via mains supply (230 V/AC).

#### Note:

You can charge the product battery and power connected AC appliances at the same time but the total available output power is reduced.

1. Connect the included mains cable to the mains input socket.
2. Connect the mains plug to a suitable mains socket.
  - The product will switch on and start the charging process.
  - The display will indicate the charging status.
3. Disconnect the mains cable from the mains input socket as soon as the product battery is fully charged.

### 9.2 Charging via solar panel

You can charge the product battery with solar power by connecting a set of solar panels to the Anderson port.

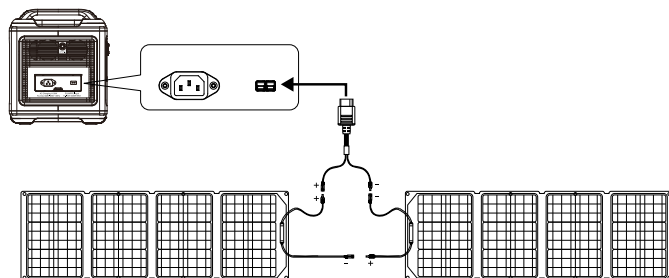

Figure 1: Solar charging setup

#### Preconditions:

Make sure your solar panel setup meets the product input specifications:

	Unit	Value
Input voltage	V/DC	11.5 - 50
PV input voltage	V/DC	11.5 - 50
Max. input current	A	20
Max. input power	W	500

#### Procedure:

1. Set up your solar panels. See [Figure 1: Solar charging setup](#) [▶ 12].
2. Connect a suitable Anderson cable to the solar panel setup.
3. Connect the Anderson cable to the Anderson input port on the product.
  - The product will switch on and start the charging process.
  - The display will indicate the charging status.

### 9.3 Charging via road vehicle (12/24 V/DC)

You can charge the product battery with your vehicle (12 or 24 V/DC) by connecting a suitable cable to the Anderson port.

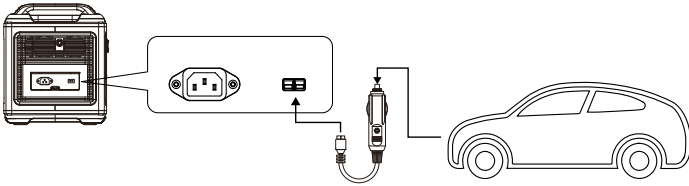

Figure 2: Car charging setup

1. Read the instructions on supplying power to external devices in the vehicle's user manual. Make sure to observe restrictions to prevent damage or hazards.
2. Use a suitable cable with Anderson/cigarette lighter plug ends and connect the vehicle to the Anderson port. See [Figure 2: Car charging setup \[▶ 13\]](#).
  - The product will switch on and start the charging process.
  - The display will indicate the charging status.

# 10 Powering devices (Output)

## 10.1 Connecting devices

The product can power AC and DC powered devices. Connect your device to a port that meets the voltage and power requirements of the device.

1. Switch off the device.
2. Select a port on the product that meets the requirements of your device you want to power. Refer to the "Technical data" of the product for details.
3. Connect the device to the port on the product that you selected. Use a suitable cable. Keep plugs clean.

## 10.2 Powering devices

After you have connected your device to the product, you can power it. The product is divided into output units that allow you to switch on and off connected devices without having to disconnect and re-connect them.

If the product is overloaded, the overload protection will shut the power supply off and you will have to reset the overload protection before you can continue powering devices.

Preconditions:

✓ You have connected devices.

1. Press and hold the power button for 3 seconds to switch the product on.
2. Press the output activation button that controls the output port to which your device is connected. For example, if your mobile phone is connected to a USB-C® output port, press the USB output activation button **USB**.
  - The connected device is supplied with power.
  - The display indicates the output power.
3. After use, press the output activation button to deactivate the output ports.

# 11 Using as UPS (uninterruptible power supply)

You can set the product up as an uninterruptible power supply (UPS) that allows you to power mains-powered devices during power outages. If a power outage occurs, the product will switch to UPS mode and temporarily take over the power supply.

**Important:**

This product is not a substitute for an industrial-grade UPS system that ensures power supply to system-critical or life-critical systems.

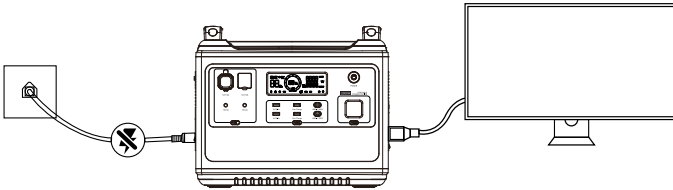

Figure 3: UPS Setup

**Preconditions:**

Make sure the below specifications satisfy your requirements:

	Unit	Value
UPS peak power (total)	W	4000
UPS rated power (total)	W	2000
Activation delay	ms	10

**Procedure:**

1. Connect the included mains cable to the mains input socket.
2. Connect the mains plug to a suitable mains socket.
3. Connect an appliance to a mains output socket. See [Figure 3: UPS Setup \[▶ 15\]](#).
4. Press and hold the power button for 3 seconds to switch the product on.
5. Press the mains output activation button **AC** to activate the mains output.
  - The connected mains appliance is powered directly from the mains supply.
  - You have set up the uninterruptible power supply (UPS). If the power grid supply interrupts, the product will power the connected AC appliance.

## 12 Configuring parameters

### 12.1 Configuring AC output voltage (220/230 V/AC)

Depending on the requirements of your appliance, you can set the AC output voltage to either 220 V/AC or 230 V/AC.

1. Quickly press the AC output activation button 10 times to change voltages.
  - The display will indicate the new voltage as "100 220" or "100 230" respectively.
  - You have changed the AC output voltage.



### 12.2 Configuring AC output voltage frequency (50/60 Hz)

Depending on the requirements of your appliance, you can set the frequency of the AC output voltage to 50 Hz or 60 Hz.

1. Press and hold the AC output activation button until "50Hz 60Hz" flashes on the display.
2. Repeatedly press the AC output activation button **AC** to select a frequency.
3. Wait until you hear a beep sound.
  - You have changed the AC output voltage frequency.



# 13 Troubleshooting

Problem	Possible cause	Suggested solution
AC input symbol  is flashing.  	Input overload protection was triggered.	<ol style="list-style-type: none"> <li>1. Press and hold the power button for 3 seconds to switch the product off.</li> <li>2. Disconnect all consumers that are connected to the product.</li> <li>3. Press and hold the power button for 3 seconds to switch the product on.</li> <li>4. Press the input overload reset button to reset the overload protection.</li> </ol> <p>→ The overload protection is reset and the product battery can be charged again.</p>
Temperature symbol  is flashing.  Alarm is sounding.	Overtemperature protection was triggered.	<ol style="list-style-type: none"> <li>1. Disable all output ports by pressing the output activation buttons.</li> <li>2. Let the product cool down.</li> </ol> <p>→ The overtemperature protection is reset and the product ready to power devices.</p>
Output port indicator symbol (example:  ) is flashing.  Alarm is sounding.	Output overload protection was triggered.	<ol style="list-style-type: none"> <li>1. Disconnect the device that triggered the overload protection.</li> <li>2. Press the output activation button that controls the output port to which your device was connected to switch the port(s) off. For example, if a heater was connected to an AC output port, press the AC output activation button <b>AC</b>.</li> </ol> <p>→ The output overload protection is reset and the product ready to power devices.</p>

## 14 Cleaning

### Important:

- Do not use aggressive cleaning agents, rubbing alcohol or other chemical solutions. They damage the housing and can cause the product to malfunction.
- Do not immerse the product in water.

1. Switch the product off.
2. Disconnect the product from the power supply.
3. Disconnect all connected cables.
4. Let the product cool down to ambient temperature.
5. Clean the product with a dry, fibre-free cloth.

## 15 Storage

1. Switch the product off.
2. Disconnect the product from the power supply.
3. Disconnect all connected cables.
4. Let the product cool down to ambient temperature.
5. Full charge the product battery.
6. Store the product in a place that satisfies the storage conditions provided in the “Technical data” and that is away from direct sunlight. Make sure children cannot access the place so that they do not play with the product.

## 16 Disposal



This symbol must appear on any electrical and electronic equipment placed on the EU market. This symbol indicates that this device should not be disposed of as unsorted municipal waste at the end of its service life.

Owners of WEEE (Waste from Electrical and Electronic Equipment) shall dispose of it separately from unsorted municipal waste. Spent batteries and accumulators, which are not enclosed by the WEEE, as well as lamps that can be removed from the WEEE in a non-destructive manner, must be removed by end users from the WEEE in a non-destructive manner before it is handed over to a collection point.

Distributors of electrical and electronic equipment are legally obliged to provide free take-back of waste. Conrad provides the following return options **free of charge** (more details on our website):

- in our Conrad offices
- at the Conrad collection points
- at the collection points of public waste management authorities or the collection points set up by manufacturers or distributors within the meaning of the ElektroG

End users are responsible for deleting personal data from the WEEE to be disposed of.

It should be noted that different obligations about the return or recycling of WEEE may apply in countries outside of Germany.

# 17 Technical data

## 17.1 Rechargeable battery

	Unit	Value
Battery type		LiFePO4
Rated battery voltage	V	51.2
Battery capacity	Ah	39
Charging methods		Mains supply, solar, road vehicle
Approx. charging duration - mains supply	h	2

## 17.2 Output power

	Unit	Value
Off-grid rated power (total)	W	2000
Off-grid peak power (total)	W	4000

## 17.3 Protection

	Unit	Value
Overheating protection		Yes
Overcharge protection		Yes
Short-circuit protection		Yes
Over-voltage protection		Yes

## 17.4 UPS (Uninterruptable power supply)

	Unit	Value
UPS peak power (total)	W	4000
UPS rated power (total)	W	2000
Activation delay	ms	10

## 17.5 Input

### AC input port

	Unit	Value
Number of ports		1
Input voltage	V/AC	220 - 240
Input voltage frequency	Hz	50
Rated power	W	1100

### Anderson input port

	Unit	Value
Number of ports		1
Input voltage	V/DC	11.5 - 50
PV input voltage	V/DC	11.5 - 50
Max. input current	A	20
Max. input power	W	500

## 17.6 DC Output

### Barrell DC output port

	Unit	Value
Number of ports		2
Output voltage	V/DC	13 - 14
Output current	A	3

### Cigarette lighter output port

	Unit	Value
Number of ports		1
Output voltage	V/DC	12.7 - 14
Output current	A	10

### XT60 output port

	Unit	Value
Number of ports		1
Output voltage	V/DC	12.7 - 14
Output current	A	10

### USB-A output port (5 V / 2.4 A)

	Unit	Value
Number of ports		2
Output voltage	V/DC	5
Output current	A	2.4
Max. output power	W	12

### USB-A output port (Fast Charge)

	Unit	Value
Number of ports		2
Output voltage/current	V/DC, A	5 V/DC, 3 A; 9 V/DC, 2A; 12 V/DC, 1.5 A
Max. output power	W	18

### USB-C® output port (100 W)

	Unit	Value
Number of ports		2
Output voltage/current	V/DC, A	5/9/12/15 V/DC, 3 A; 20 V/DC, 5 A
Max. output power	W	100

## 17.7 AC output

	Unit	Value
Number of ports		3
Output voltage	V/AC	220/230
Output voltage frequency	Hz	50
Rated power (all sockets)	W	2000
Peak power (all sockets)	W	4000
Output wave form		Pure sine wave
Efficiency	%	90

## 17.8 Light

	Unit	Value
Power consumption	W	0.8
Colour temperature	K	4000

## 17.9 Operating and storage environment

	Unit	Value
Operating temperature - Charging	°C	0 to +45
Operating temperature - Discharging	°C	-18 to +45
Operating humidity (non-condensing)	% RH	10 - 90
Storage temperature	°C	0 to +25
Storage humidity (non-condensing)	% RH	10 - 90

## 17.10 Others

	Unit	Value
Dimensions (L x W x H)	mm	392 x 279 x 323
Weight	kg	22





This is a publication by Conrad Electronic SE, Klaus-Conrad-Str. 1, D-92240 Hirschau ([www.conrad.com](http://www.conrad.com)).

All rights including translation reserved. Reproduction by any method (e.g. photocopying, microfilming or the capture in electronic data processing systems) requires prior written approval from the editor. Reprinting, also in part, is prohibited. This publication reflects the technical status at the time of printing.

Copyright by Conrad Electronic SE \*2619335\_V3\_1122\_jh\_mh\_en 36028797669008907 I5/O3 en

---