



secu **ENTRY**

en

# Master Operating Instructions

## secuENTRY Set

### ENTRY Home 5001 PIN



**BURG-WÄCHTER KG**  
Altenhofer Weg 15  
58300 Wetter  
Germany

[www.burg.biz](http://www.burg.biz)

## Contents index

en English ..... 2

Further languages at:

[www.burg.biz](http://www.burg.biz)

## Foreword

Dear Customer,

Thank you very much for deciding on the secuENTRY Set ENTRY Home 5001 PIN, consisting of the *ENTRY 5000 CYL* cylinder and the *ENTRY 7711 Keypad PIN*.

The system was developed in Germany according to the most modern technical capabilities and fulfils the latest high safety requirements.

The ENTRY 5000 CYL electronic cylinder can be easily installed in any door with a profile cylinder lock, up to a door thickness of 118 mm (59/59 mm, measured in the centre of the forend screw). No drilling or laying of cables is required and it is ideally suited for both new installations and retrofitting. The ENTRY 5000 CYL can be fitted to house and interior doors.

Using the *ENTRY 7711 Keypad PIN*, you can unlock and lock the door with a 6-digit user code. The *ENTRY 7711 Keypad PIN* can be installed up to approx. four metres from the locking unit, depending on preference and conditions.

The ENTRY Home 5001 PIN is setup and operated using the free smartphone app *secuENTRY KeyApp*\*. The transmission is wireless, the cylinder and keypad both use the modern Bluetooth 5.2 standard.

\* Alternatively, the cylinder can also be operated via the radio key *ENTRY sE-Key 7713* (available separately). The *secuENTRY KeyApp*, however, is always required for the setup.

### ! Important:

- Please read the entire operating instructions before you start the installation.

We hope you enjoy your new locking system!

## Set contents

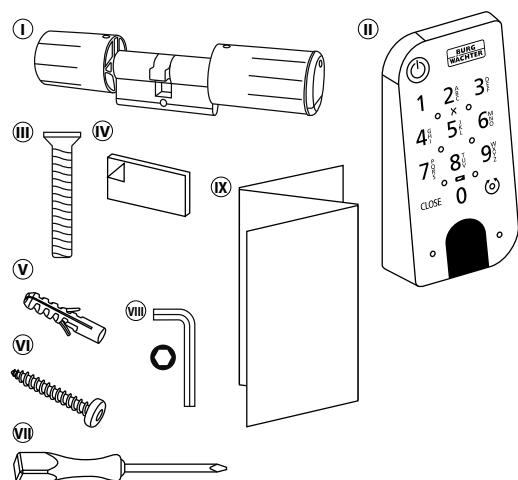

Fig. 1

①	ENTRY Home 5000 CYL Cylinder
②	ENTRY 7711 Keypad PIN
③	Forend screw
④	Adhesive pads (4x)
⑤	Dowels (3x)
⑥	Screws (3x)
⑦	Screwdriver Tx8
⑧	Hexagon spanner SW2
⑨	Quick Start Guide plus warranty and disposal instructions

## Technical data - ENTRY Home 5000 CYL Cylinder

Cylinder unit power supply	2x Mignon LR6 AA Alkaline
Permitted ambient conditions	-15 °C/+50 °C / up to 95 % relative humidity (non-condensing)
Radio standard	Bluetooth 5.2
Transmission power	≤ 10 dBm
Frequency range	2,4 - 2,483 GHz
Range	Approx. 4 m
Number of access media	1 user code + 5 sE-Keys* or 5 KeyApp connections

## Technical data - ENTRY 7711 Keypad PIN

Keypad power supply	2x Mignon LR6 AA Alkaline
Permitted ambient conditions	-15 °C/+50 °C / up to 95 % relative humidity (non-condensing)
Radio standard	Bluetooth 5.2
Transmission power	≤ 10 dBm
Frequency range	2,4 - 2,483 GHz
Range	Approx. 4 m
Weather protection class (IP class)	IP53
Blocking times	After an incorrect code is entered 3x, 1 minute, thereafter always 3 minutes

\* Radio key ENTRY sE-Key 7713 available as an option.

## ENTRY 7711 Keypad PIN

The *ENTRY 7711 Keypad PIN* can be used to operate electronic secuENTRY cylinders from BURG-WÄCHTER. Communication between the keypad and the profile cylinder is 128-bit AES encrypted.

Operation on the illuminated keypad is carried out via push-buttons. Consequently, the keypad can be easily operated even in poor lighting conditions.

The *ENTRY 7711 Keypad PIN* enables the door to be opened and closed with the aid of a 6-digit PIN code. There are one million possible number combinations for generating the code.

The integrated tamper protection locks the entry for one minute after three incorrect entry attempts. From the fourth incorrect entry, the keypad is locked for three minutes each time.

The keypad is splash-proof on all sides according to IP53 certification.

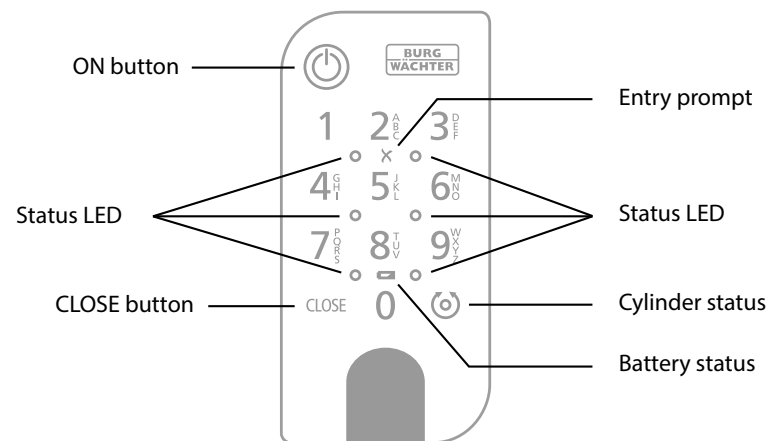

Fig. 2

	ON button	Activates the keypad. An entry "Opened" (ON button) or "Closed" (CLOSE button) is generated in the secuENTRY cylinder history. This allows for the "Open" and "Close" operations to be differentiated in the history.
CLOSE	CLOSE button	
	Error message	The two LEDs next to the X symbol will illuminate if an invalid number combination is entered or if general errors occur.
	Battery status	The system monitors the keypad and cylinder battery voltage. The user is alerted as soon as the battery voltage reaches a critical range. Batteries must be changed as soon as possible after the battery status symbol illuminates.
	Cylinder status	When the number combination entered is correct, the cylinder status symbol will illuminate and the door can be unlocked or locked.
	Status LED	The LEDs illuminate one after the other in a clockwise direction when the keypad is in programming mode (see chapter below).

## QR code/Administrator code

The QR code (I) is required later when setting up the set using the BURG-WÄCHTER KeyApp (Fig. 3).

The sets are delivered with a factory-assigned random administrator code (II), therefore a code change is not mandatory (Fig. 3).

### Attention:

The QR code and the factory-assigned administrator code are not stored by BURG-WÄCHTER. Recovery is not possible if the codes are lost. Please store the sticker shown above in a safe place. In addition, it is recommended that you take a photo of the sticker and archive it digitally.

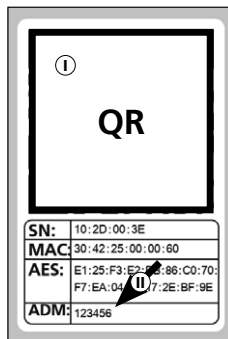

Fig. 3

## ENTRY Home 5001 PIN commissioning

- To setup your new locking system, you must first download the secuENTRY KeyApp. This can be found in the App Store and Google Play Store (Fig. 4).



Fig. 4

Once you have successfully registered, you can start setting up the secuENTRY 5000 CYL.

- Note:** The keypad is supplied from the factory with the cylinder already connected, therefore there is no need for a separate setup.

- Open the main menu (Fig. 5).
- Tap on the menu item "secuENTRY setup" (Fig. 6).

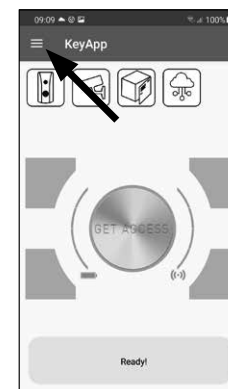

Fig. 5

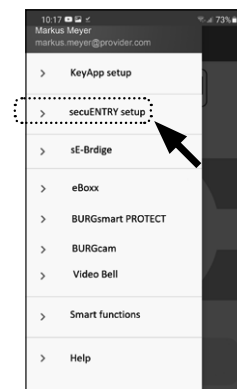

Fig. 6

- In the following menu, tap on "Device Setup" (Fig. 7). From here you can add and setup secuENTRY units to the app.
- Use the selection menu displayed and tap on "secuENTRY Profily Cylinder" to setup your secuENTRY cylinder (Fig. 8).

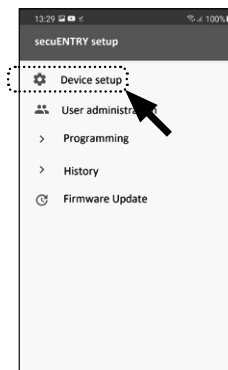

Fig. 7

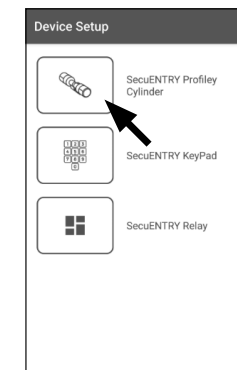

Fig. 8

- A list is displayed in which cylinders that have already been registered can be found at a later date. This list is, of course, empty when installing the secuENTRY KeyApp and setting up a cylinder for the first time.
- Add a new cylinder by tapping on the "+" in the top right-hand corner (Fig. 9).

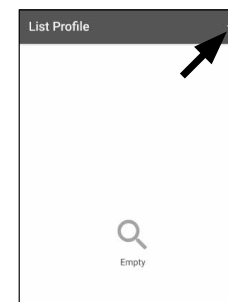

Fig. 9

8 A prompt will appear asking you to scan the QR code provided using your smartphone camera. The QR code is on the sticker enclosed in the packaging (see small fig.).

9 Tap on "Continue" (Fig. 10). You may be asked to confirm the app's access to the camera. The camera's picture window will then open (Fig. 11). Scan the QR code.

10 A message appears containing data about your cylinder, confirm this with "OK" at the bottom right (Fig. 12).

11 The following window gives you the option of assigning a name to the cylinder. If several cylinders are used, it is recommended to name the cylinder in a way that you can directly recognise where the cylinder is located or attached. Confirm the name with "OK" (Fig. 13).

12 A message appears informing you that you can change your administrator code. As you received a randomly generated administrator code at the time of delivery, this step is optional. Use "SKIP" to bypass it (I), (Fig. 14).

**Note:** The administrator code can be changed at any time at a later date. Instructions on how to do this can be found in the chapter "Change administrator code" on page 4.

13 Should you wish to change the administrator code immediately during setup, tap on "CONTINUE" (II) (Fig. 14) for the corresponding request. This then leads directly to the "Change administrator code" function, which is also described in the following chapter on page 4, at point 5.

14 Your secuENTRY cylinder is now fully setup. It will now appear in the list of setup cylinders (Fig. 15).

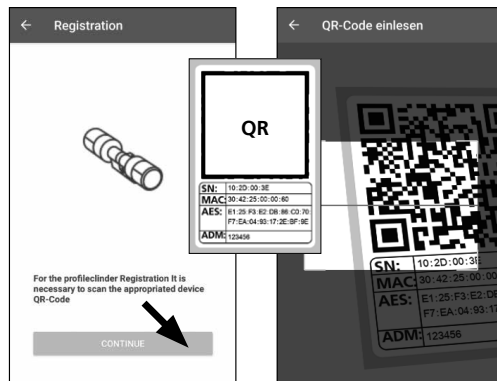

Fig. 10

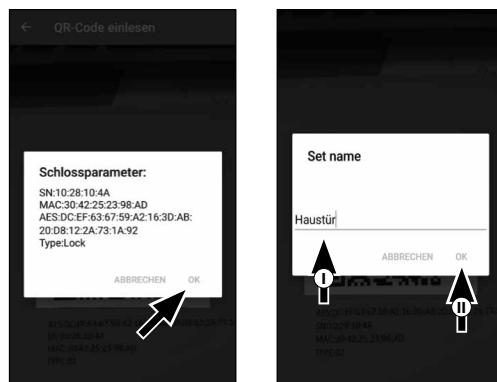

Fig. 11

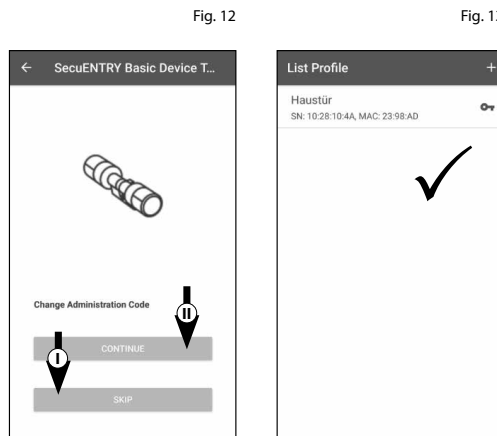

Fig. 12

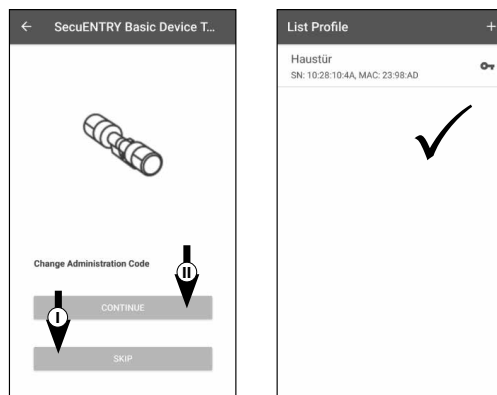

Fig. 13



Fig. 14

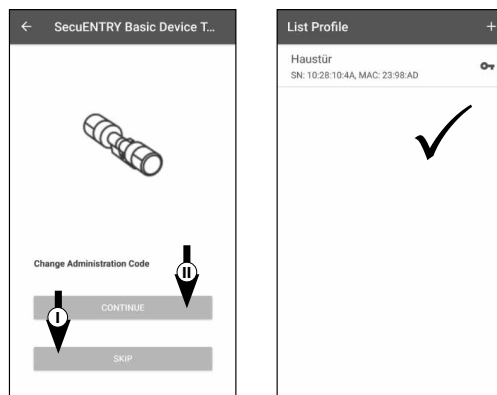

Fig. 15

## Change administrator code

To change the administrator code, please proceed as follows:

- 1 Open the main menu (Fig. 16).
- 2 Tap on the menu item "secuENTRY setup" (Fig. 17).
- 3 In the following menu, tap on "Device Setup" (Fig. 18).
- 4 Use the selection menu displayed and tap on "secuENTRY Profily Cylinder" (Fig. 19).
- 5 A list with setup cylinders is displayed. Select the required cylinder (I) and tap on "Set Admin Code" (II) (Fig. 20).
- 6 Enter the pre-existing administrator code, followed by entering your desired administrator code twice (I). Confirm the entries with "CHANGE CODE" (II) (Fig. 21).

**Tip:** The entry is concealed. Tap the eye symbol on the right side to visualise and check the entry.

**Attention:** Do not select simple codes that are easy to guess (e.g. 1-2-3-4-5-6). Also, do not select any personal information (e.g. birthdays) or other information that can be easily deduced by persons who know the user.

Press the "SKIP" button to cancel the process, the administrator code will not be changed (III) (Fig. 21).

- 7 A message is displayed if the change has been made successfully.

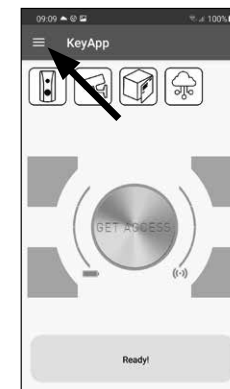

Fig. 16

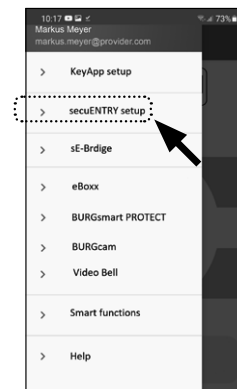

Fig. 17



Fig. 18

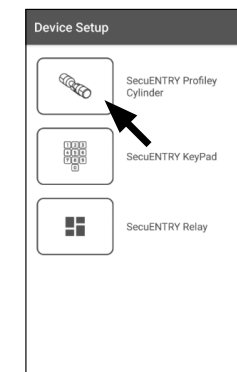

Fig. 19

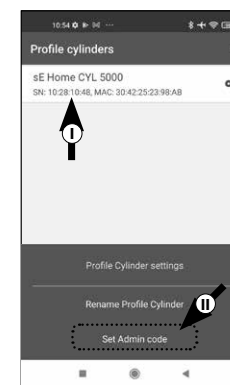

Fig. 20

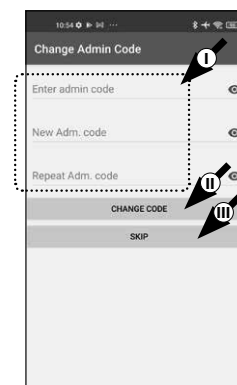

Fig. 21

## Delete cylinder

Proceed as follows to delete a cylinder:

- ① Open the main menu (Fig. 22).
- ② Tap on the menu item "secuENTRY setup" (Fig. 23).
- ③ In the following menu, tap on "Device Setup" (Fig. 24).
- ④ Use the selection menu displayed and tap on "secuENTRY Profily Cylinder" (Fig. 25).
- ⑤ A list with setup cylinders is displayed. Swipe the entry of the cylinder you wish to delete to the left (I) and tap on the "DELETE" field (II) that appears on the right (Fig. 26).

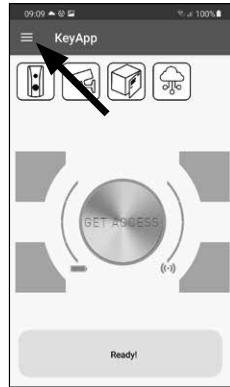

Fig. 22



Fig. 23

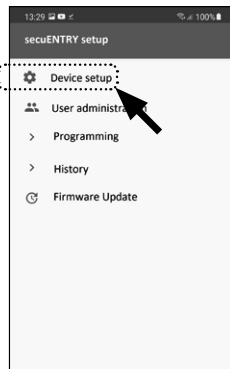

Fig. 24

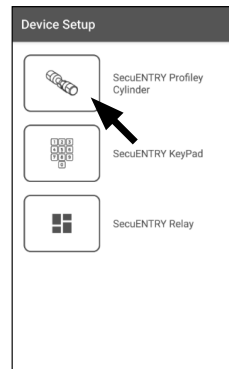

Fig. 25

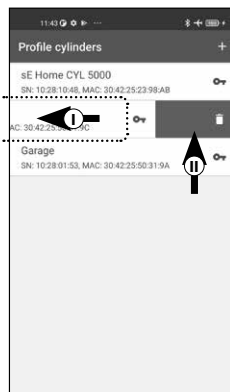

Fig. 26

## Create user and assign access medium

There are various access media available to open your door. Including opening with a user-defined code\*, the sE-Key™ radio key and the KeyApp itself.

Once you have created a secuENTRY cylinder in the KeyApp, you are the administrator of this cylinder. This function allows you to create users for yourself and others and to assign one access medium per user.

**! Attention:** For the ENTRY Home 5000 CYL cylinder, a maximum of six users can be created, each with one access medium. One user code and five sE-Keys\* or five KeyApps as electronic keys.

\* Radio key ENTRY sE-Key 7713 available as an option.

## Create user

- ① Open the main menu (Fig. 27).
- ② Tap on the menu item "secuENTRY setup" (Fig. 28).
- ③ Tap on "User administration" in the submenu (Fig. 29).
- ④ A list of users that have already been created is displayed. Create a new user by tapping on the "+" in the top right-hand corner (Fig. 30).

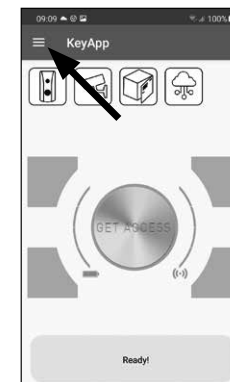

Fig. 27

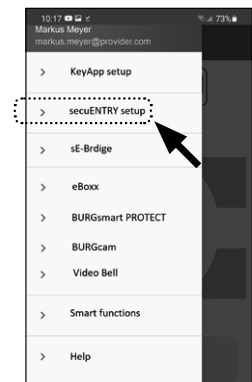

Fig. 28

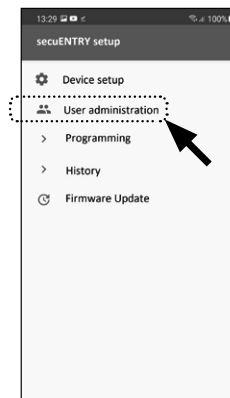

Fig. 29

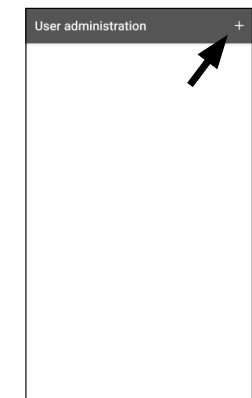

Fig. 30

- Enter the first name and surname of the user you wish to register (I) (Fig. 30).

This section allows you to set up a user code, a radio key sE-Key or another smartphone as an electronic key (II) (Fig. 31).

Proceeding from this menu view, look at the following chapters and continue with the desired access medium.

- Note:** Only one access medium is possible per user.

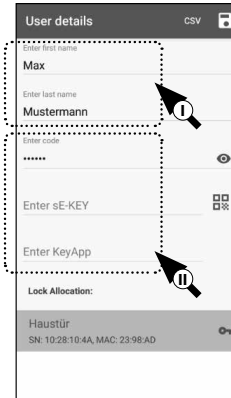

Fig. 31

### Create user – User code

- Note:** A user code can be used as an opening medium in conjunction with the keypad included in the set. The keypad is supplied from the factory with the cylinder already connected, therefore there is no need for a separate setup.

- Enter a user-defined code (I) (Fig. 32).

- Tip:** The entry is concealed. Tap the eye symbol on the right side to visualise and check the entry.

- Attention:** Do not select simple codes that are easy to guess (e.g. 1-2-3-4-5-6). Also, do not select any personal information (e.g. birthdays) or other information that can be easily be deduced by persons who know the user.

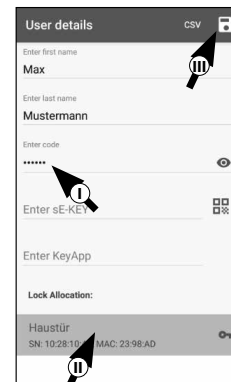

Fig. 32

- Next, assign a cylinder by tapping it in the list of cylinders already registered (II) (Fig. 32).
- Save your settings by tapping the disk symbol in the top right-hand corner (III).
- The user has now been assigned the user code and the selected lock within the KeyApp (Fig. 32). The programming process must be started so that the cylinder also receives this information. The corresponding description can be found in the chapter "Programming/ Updating the cylinder" on page 11.

### Create user – Radio key sE-Key

- Note:** The radio key "ENTRY sE-Key 7713" is available separately from specialist retailers. You can connect a maximum of five radio keys.

A radio key is connected by scanning the QR code enclosed with the sE-Key.

- Tap the QR code symbol in the "Enter sE-KEY" line in the user menu (Fig. 33).

You may be asked to confirm the app's access to the camera. The camera's picture window will then open (Fig. 34). Scan the QR code.

- A message appears containing data about your radio key, confirm this with "OK" at the bottom right (Fig. 35).

- Next, assign a cylinder by tapping it in the list of cylinders already registered (I) and save your settings by tapping on the disk symbol at the top right (II) (Fig. 36).

- The user has now been assigned the radio key and the selected lock within the KeyApp. The programming process must be started so that the cylinder also receives this information. The corresponding description can be found in the chapter "Programming/ Updating the cylinder" on page 11.

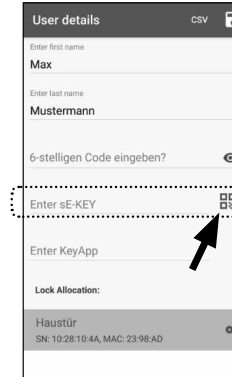

Fig. 33



Fig. 34

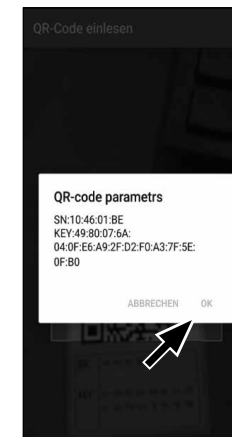

Fig. 35

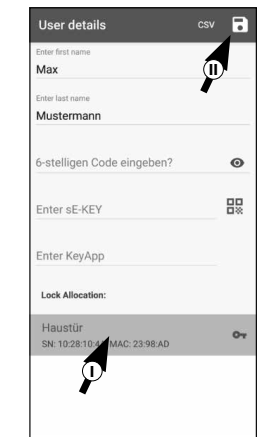

Fig. 36

## Create user – KeyApp as an electronic key

The KeyApp allows you to open the lock with the help of another smartphone. The installation has two different options for this method of opening:

**Option 1:** via a QR code

**Option 2:** via a CSV file

Instructions for each option are given below. It doesn't matter which of the two procedures you choose, they both lead to the same result.

! **Note:** You can connect a maximum of five smartphones as electronic keys.

! **Note:** To simplify the explanation, the administrator or their smartphone is referred to below as 'smartphone A' and the smartphone of the user who is to receive opening authorisation is referred to as 'smartphone B'.

### Option 1: QR code

#### Smartphone B:

- 1 First, download the secuENTRY KeyApp and register.
- 2 Open the main menu (Fig. 37).
- 3 Tap on the menu item "KeyApp setup" (Fig. 38).
- 4 Tap on "Key functions" (Fig. 39).
- 5 In the next menu, tap on "QR code" (Fig. 40), after which a QR code is displayed on the entire screen.
- 6 Leave the QR code displayed on the screen and put the smartphone B aside for a moment. The next steps are performed on smartphone A.

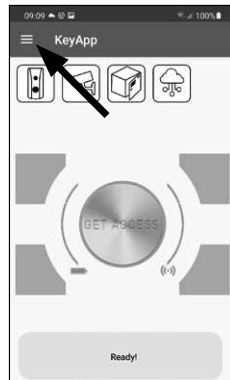

Fig. 37

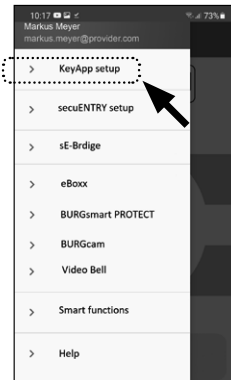

Fig. 38

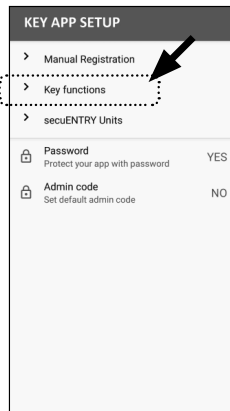

Fig. 39

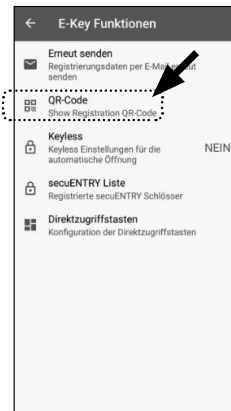

Fig. 40

#### Smartphone A:

The QR code displayed on smartphone B can now be scanned via the app on smartphone A.

- 1 Tap the QR code symbol in the "Enter KeyApp" line in the user menu (Fig. 41).
- 2 You may be asked to confirm the app's access to the camera. The camera's picture window will then open (Fig. 42). Scan the QR code on the smartphone B screen.
- 3 A message appears containing data about the KeyApp on smartphone B, confirm this with "OK" at the bottom right (Fig. 43).
- 4 Next, assign a cylinder by tapping it in the list of cylinders already registered (I) and save your settings by tapping on the disk symbol at the top right (II) (Fig. 44).
- 5 The user has now been assigned another KeyApp as an electronic key and the selected lock within the KeyApp. The programming process must be started so that the cylinder also receives this information. The corresponding description can be found in the chapter "Programming/ Updating the cylinder" on page 11.



Fig. 41

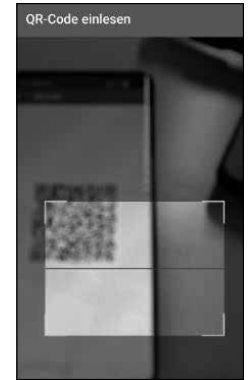

Fig. 42

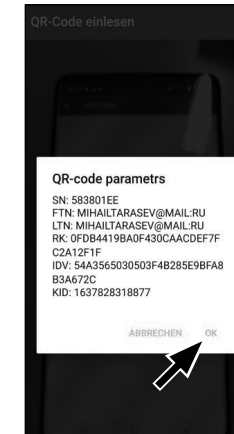

Fig. 43

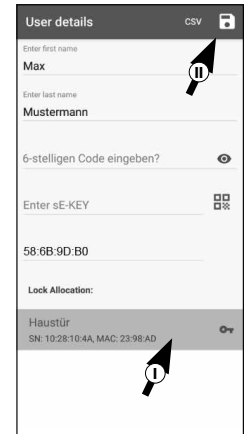

Fig. 44

## Option 2: CSV file

### Smartphone B:

- 1 First, download the secuENTRY KeyApp and register.
- 2 Open the main menu (Fig. 45).
- 3 Tap on the menu item "KeyApp setup" (Fig. 46).

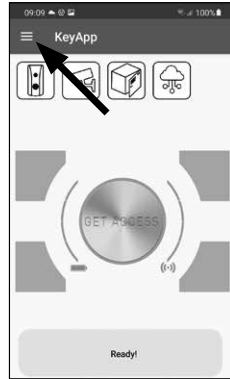

Fig. 45

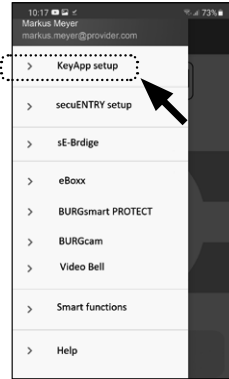

Fig. 46

- 4 Tap on "Key functions" (Fig. 47).
- 5 Tap on "Send again" in the next menu (Fig. 48).

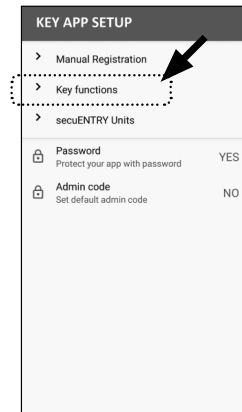

Fig. 47

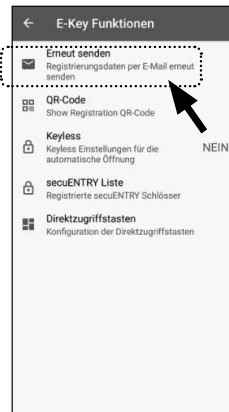

Fig. 48

- 6 An email is then automatically created and opened in your email program. The attachment contains a registration file with the extension ".csv" (Fig. 49).
- 7 Send the email to an email address that can be retrieved by smartphone A.

Put smartphone B aside, and the rest of the procedure will be performed on smartphone A.

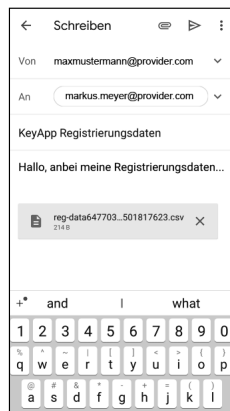

Fig. 49

### Smartphone A:

- 1 Temporarily store the file received from smartphone B on smartphone A. The file can be deleted again after programming.
- 2 Tap on "CSV" in the user menu at the top right (Fig. 50).
- 3 Select the CSV file that you received by email from smartphone B (I). Confirm the selection at the top right with the tick (Fig. 51).
- 4 The data is now recorded in the KeyApp.
- 5 Next, assign a cylinder by tapping it in the list of cylinders already registered and save your settings by tapping on the disk symbol at the top right (Fig. 52).
- 6 The user has now been assigned another KeyApp as an electronic key and the selected lock within the KeyApp. The programming process must be started so that the cylinder also receives this information. The corresponding description can be found in the chapter "Programming/ Updating the cylinder" on page 11.
- 7 The CSV file temporarily stored on smartphone A can now be deleted.

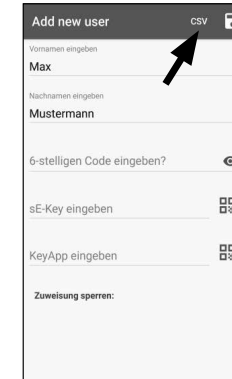

Fig. 50

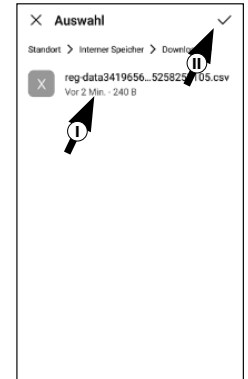

Fig. 51

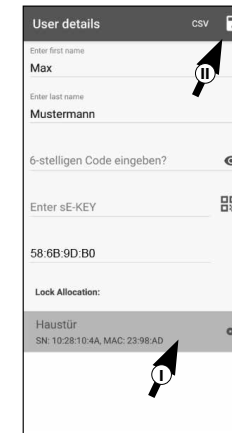

Fig. 52



## Changing the user access medium

Proceed as follows if you wish to change an opening medium assigned to a user:

- 1 Open the main menu (Fig. 53).
- 2 Tap on the menu item "secuENTRY setup" (Fig. 54).
- 3 Tap on "User administration" in the submenu (Fig. 55).
- 4 In the list of created users, tap the user for which you want to change the user code (Fig. 56).
- 5 The data view for the required user appears (Fig. 57). Proceeding from this menu view, look at the following chapters and continue with the desired access medium.

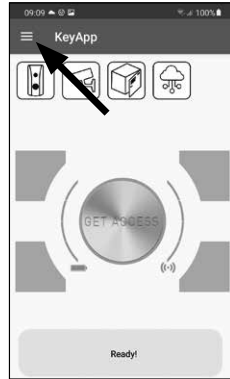

Fig. 53



Fig. 54

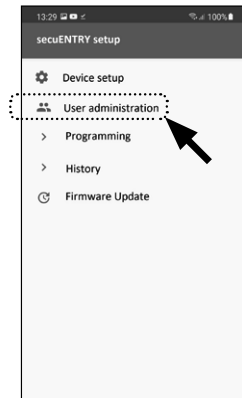

Fig. 55

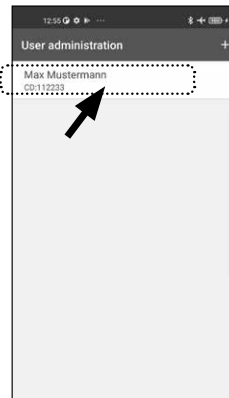

Fig. 56

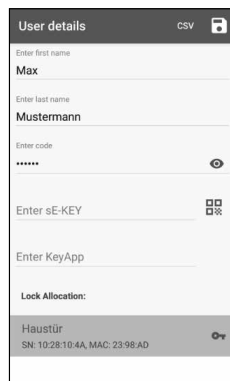

Fig. 57

## Changing the user access medium - User code

- 1 Delete the entry of the relevant line and, if required, enter a new user-defined code (I) (Fig. 58).
  - ! **Tip:** The entry is concealed. Tap the eye symbol on the right side to visualise and check the entry.
  - ! **Attention:** Do not select simple codes that are easy to guess (e.g. 1-2-3-4-5-6). Also, do not select any personal information (e.g. birthdays) or other information that can be easily be deduced by persons who know the user.
- 2 Save your settings by tapping the disk symbol in the top right-hand corner (II) (Fig. 58).
- ! **Note:** It is also possible to assign a different access medium instead of a new user code. To do this, follow the chapter "Create user and assign an access medium" on page 5.

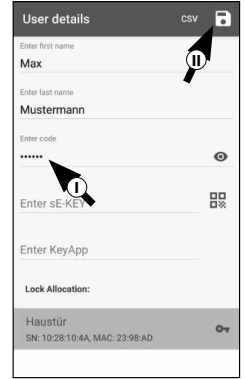

Fig. 58

## Changing the user access medium - Radio key sE-Key

- 1 Tap the relevant line (Fig. 59) to delete the entry.
- 2 A message will then appear prompting you to confirm (Fig. 60). Tap on "OK".
- 3 Now you can enter another sE key or another access medium. To do this, follow the chapter "Create user and assign an access medium" on page 5.

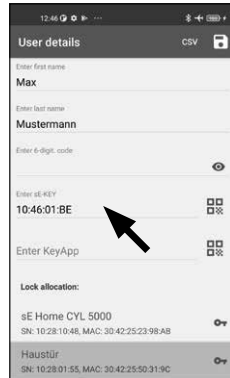

Fig. 59

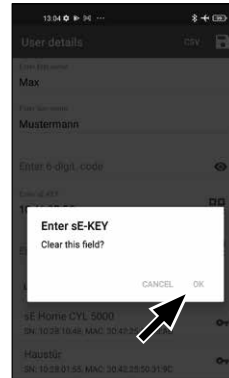

Fig. 60

## Changing the user access medium - KeyApp as electronic radio key

- 1 Tap the relevant line (Fig. 61) to delete the entry.
- 2 A message will then appear prompting you to confirm (Fig. 62). Tap on "OK".
- 3 Now you can enter another another KeyApp as an electronic key or another access medium. To do this, follow the chapter "Create user and assign an access medium" on page 5.

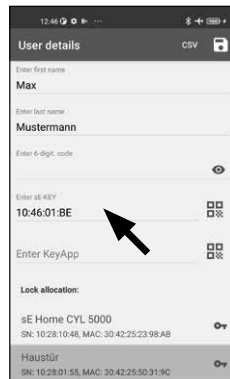

Fig. 61

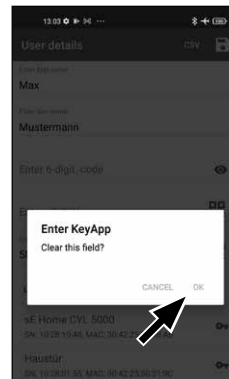

Fig. 62

## Delete user

Proceed as follows to delete a user:

- 1 Open the main menu (Fig. 63).
- 2 Tap on the menu item "secuENTRY setup" (Fig. 64).
- 3 Tap on "User administration" in the submenu (Fig. 65).
- 4 A list of users is displayed. Swipe the entry of the user you wish to delete to the left (I) and tap on the "DELETE" field (II) that appears on the right (Fig. 66).

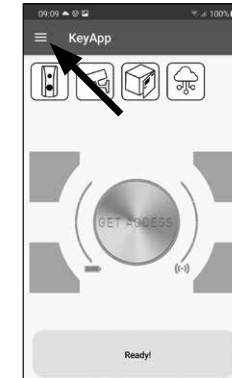

Fig. 63

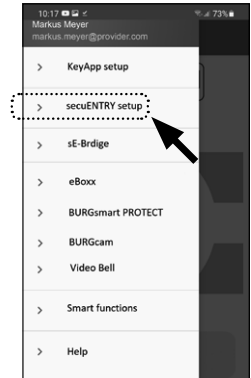

Fig. 64

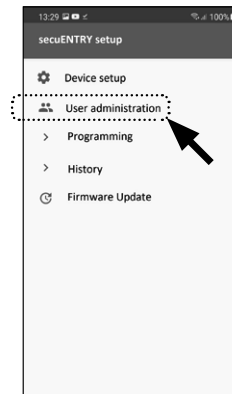

Fig. 65

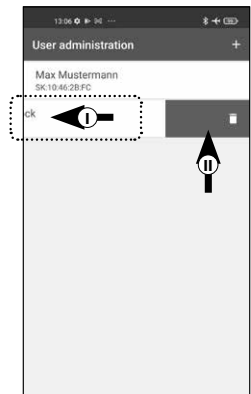

Fig. 66

## Programming/updating the cylinder

The cylinder must be programmed accordingly so that the registered users can now open the lock with the stored opening options. Program the cylinder as follows:

- ① Open the main menu (Fig. 67).
  - ② Tap on the menu item "secuENTRY setup" (Fig. 68).
  - ③ Tap on "Programming" in the submenu (Fig. 69).
  - ④ The list of programming files appears. This is where the required changes are generated in programming files and collected for sending to the cylinder. By default, the list is empty because there is no collection. If there are still earlier programming files in the list, delete them by sliding the respective entry from right to left (Fig. 70).
  - ⑤ Tap the "+" at the top right to add your required changes or the corresponding cylinder to the list (Fig. 71).
  - ⑥ Select the cylinder for which you have set up changes (I) (Fig. 72).
- !** **Note:** If you have several cylinders and have created changes for each, please only select the cylinder within the Bluetooth range of which you are located.
- ⑦ Then tap on "PROG.FILE" (II) at the top right (Fig. 72).

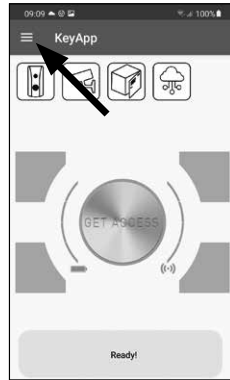

Fig. 67



Fig. 68



Fig. 69

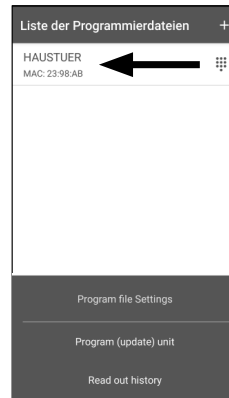

Fig. 70

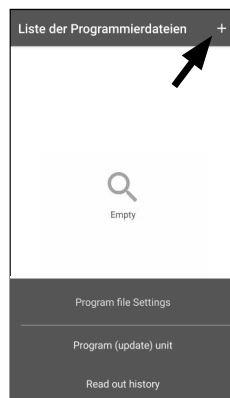

Fig. 71

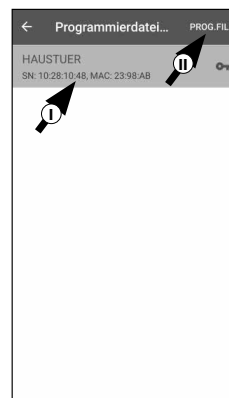

Fig. 72

- ⑧ You will then be prompted to enter your admin code (I) and confirm with "OK" (II) (Fig. 73).

- ⑨ A message appears stating that the programming file has been generated. Confirm the name with "OK" (Fig. 74).

- ⑩ Select the programming file that is now in the list (I) and tap on "Program (update) unit" (II) (Fig. 75).

**!** **Note:** If you have generated several programming files for several cylinders, please only select the cylinder within the Bluetooth range of which you are located.

- ⑪ Once again you will be prompted to enter your administrator code (Fig. 76).

- ⑫ After entering the code (I), keep your smartphone close to the cylinder (max. 2 m) and tap on "START" to start programming (II).

- ⑬ The loading window indicates that programming has started and the current status of the programming (Fig. 77).

- ⑭ As soon as the programming has been completed successfully, you will receive a corresponding feedback. Confirm the name with "OK" (Fig. 78).

- ⑮ If the process failed, repeat the steps starting from step 6.

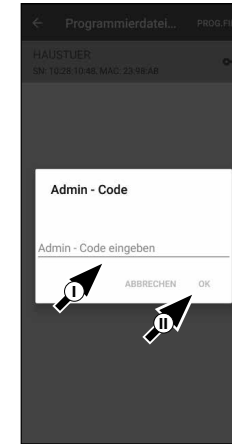

Fig. 73



Fig. 74

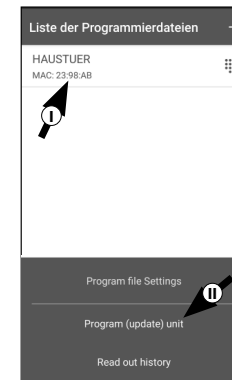

Fig. 75



Fig. 76

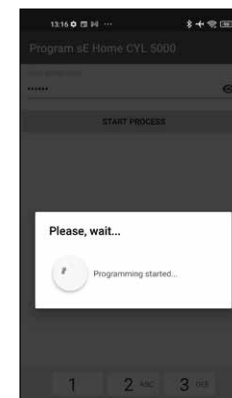

Fig. 77

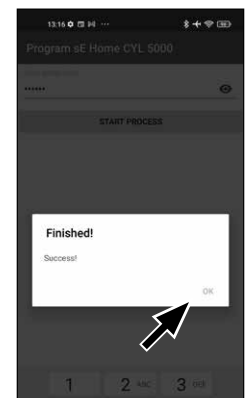

Fig. 78

## Using the cylinder and keypad

To use the cylinder (Fig. 79) and keypad (Fig. 80), remove the battery protection strips.

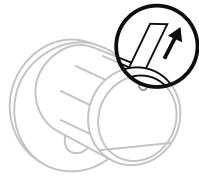

Fig. 79

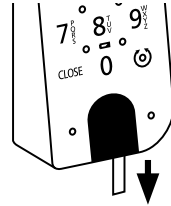

Fig. 80

## Opening the secuENTRY lock

The ENTRY Home 5001 PIN set allows you to open the lock via KeyApp or via keypad/user.

### Opening the secuENTRY lock with the secuENTRY KeyApp

Proceed as follows to open the ENTRY Home 5000 CYL cylinder and consequently also the door:

- 1 Open the secuENTRY KeyApp and press the "GET ACCESS" button in the middle (Fig. 81).

**! Note:** The secuENTRY KeyApp is programmed so that when more than one cylinder is used, it automatically adjusts to the cylinder that is within the shortest distance of the smartphone. Each cylinder can be opened by pressing the "Get Access" button.

- 2 The cylinder is now released and the lock can be opened (fig. 82) or locked (fig. 83).

**! Note:** Depending on the door stop, the direction of rotation may be reversed.

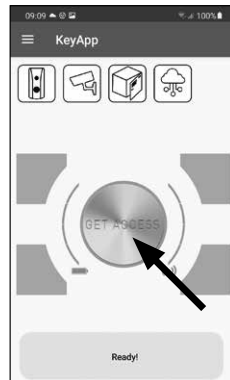

Fig. 81

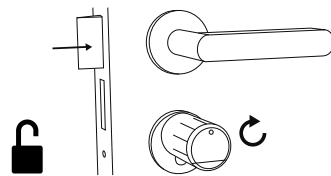

Fig. 82

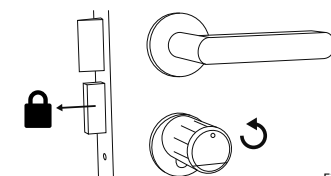

Fig. 83

## Opening the secuENTRY lock using the keypad

- 1 Activate the keypad by pressing either the ON key or the CLOSE key (I) (Fig. 84).

An entry "Opened" (ON button) or "Closed" (CLOSE button) is generated in the cylinder history. This allows for the "Open" and "Close" operations to be differentiated in the history.

**! Note:** For further details on the history function, please refer to the "Reading out the log file/history" chapter on page 13.

- 2 Type in your 6-digit administrator code or user code (II) (Fig. 84).

**! Note:** For further details on the subjects of administrator and user codes, please refer to the chapters "QR code/administrator code" on page 3 and "Create user and assign access medium" on page 5.

- 3 When the number combination entered is correct, the cylinder status symbol (⊙) will illuminate and the door can be unlocked (Fig. 85) or locked (Fig. 86).

**! Note:** Depending on the door stop, the direction of rotation may be reversed.

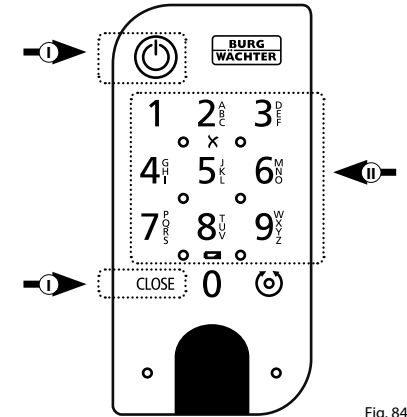

Fig. 84

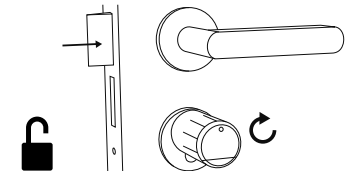

Fig. 85

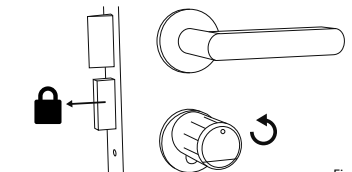

Fig. 86

## Reading out the log file/history

An entry is automatically created in a log file, the history, for every opening or closing process. Follow the steps below to read out the history.

- 1 Open the main menu (Fig. 87).
- 2 Tap on the menu item "secuENTRY setup" (Fig. 88).

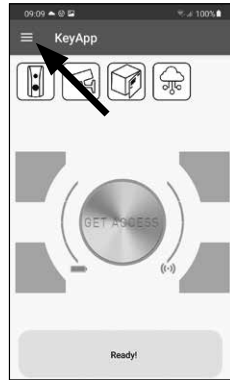

Fig. 87



Fig. 88

- 3 Tap on "History" in the submenu (Fig. 89).

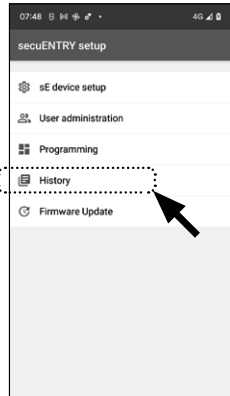

Fig. 89

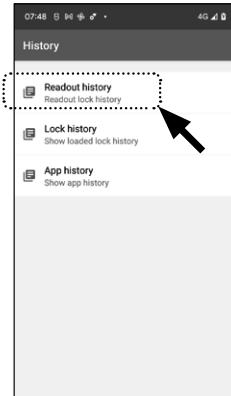

Fig. 90

**Note:** To perform the following step, you must be close to the cylinder for which you want to read out the history.

- 4 Now tap on "Readout history". This will retrieve the history data from the cylinder (Fig. 90).

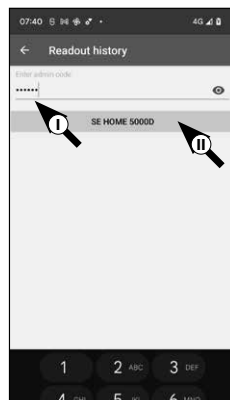

Fig. 91

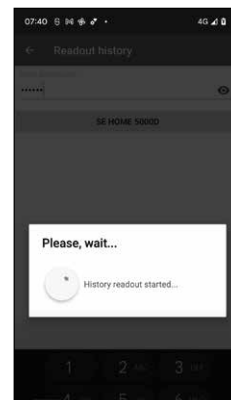

Fig. 92

- 5 Next, you will be prompted to type in your administrator code (I) (Fig. 91).

**Tip:** The entry is concealed. Tap the eye symbol on the right side to visualise and check the entry.

- 6 Below the entry field is a large button which is automatically titled with the name of the respective cylinder. Tap it to confirm (II) (Fig. 91).

- 7 The history data is now retrieved from the cylinder and stored in the app as a log file (Fig. 92).

- 8 After retrieval, a confirmation message appears, which you confirm with "OK" (Fig. 93).

- 9 Go back one step in the menu and tap on the item "Lock history" (Fig. 94).

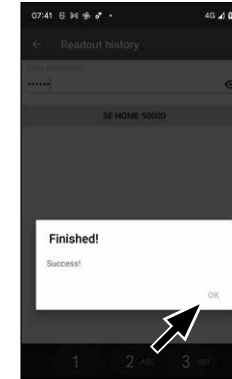

Fig. 93

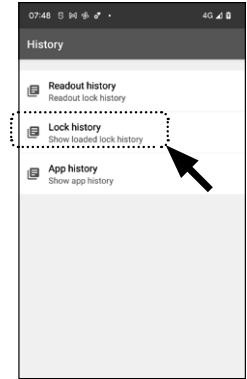

Fig. 94

- 10 A list of cylinders with retrieved log files appears. Select the required cylinder (Fig. 95).

- 11 The menu of the selected cylinder shows the retrieved log file(s), sorted by date and time. Tap the required file (Fig. 96).



Fig. 95

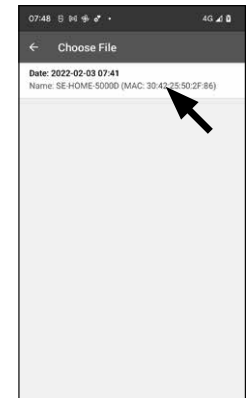

Fig. 96

**Note:** The log files only show the history up to the time of retrieval. Old cylinder entries and log files can be deleted by swiping the corresponding entry to the left. A "Delete" button then appears on the right-hand side.

- 12 The lock history is now displayed (Fig. 97).

The following data is logged for the ENTRY Home 5000 CYL:

Ⓛ Administrator 00.00.2000 00:00 Code entry  
 00.00.2000 00:00 Door opened Bat. 4/4 Full

- Ⓛ : User
- Ⓜ : Access medium
- ⓂⓂ : Opening/closing the cylinder
- ⓂⓂ : Battery status



Fig. 97

## secuENTRY 5000 CYL installation

The installation of the secuENTRY 5000 CYL is explained below. Prior to installation, please read the installation instructions carefully.

- 1 Remove the existing door lock cylinder by loosening the forend screw in the door and pulling out the cylinder with the key inserted (Fig. 98).

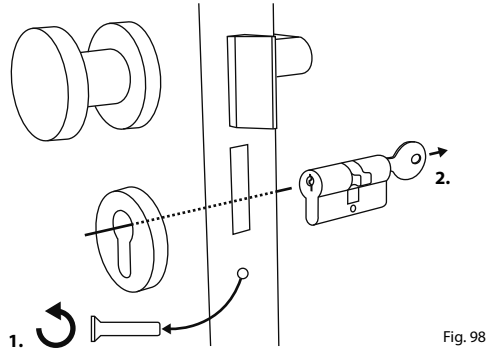

Fig. 98

- 2 Remove the two hexagonal screws in the two knobs with the enclosed hexagonal spanner (Fig. 99).

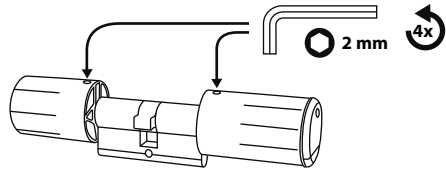

Fig. 99

- 3 Pull off the knob on the outside completely and pull the knob on the inside as far back as possible (Fig. 100).

**! Tip:** The knob on the inside is larger than the knob on the outside.

**! Attention:** The knob on the inside cannot be pulled off. Do not try to loosen it by force.

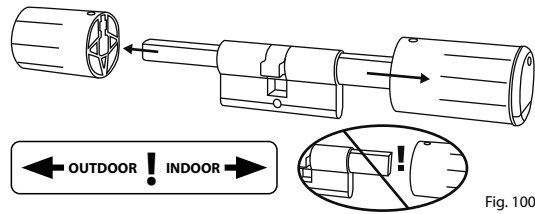

Fig. 100

- 4 From inside the door, push the cylinder into the mortise lock (Fig. 101).

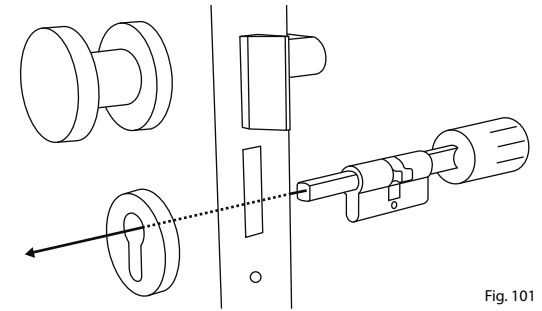

Fig. 101

- 5 Screw the cylinder into the door and push the inside and outside knobs up to the door (Fig. 102).



Abb. 102

- 6 Screw the hexagonal screws back into the two knobs (Fig. 103).

**! Attention:** Ensure that the knob is at least one millimetre away from the door.

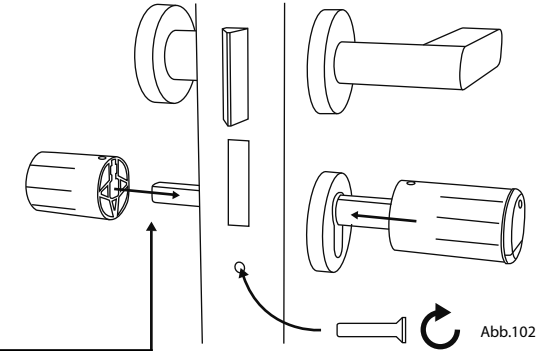
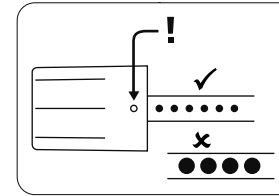

Abb. 103

- 7 If you have not already done so, remove the battery protection strip from the battery compartment on the inside knob (Fig. 104).

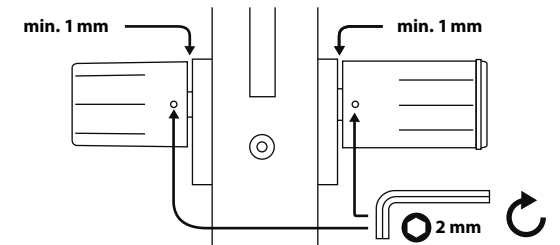

Abb. 104

## ENTRY 7711 Keypad PIN installation

The installation of the *ENTRY 7711 Keypad PIN* is explained below.

There are two options to choose from for installation. The *ENTRY 7711 Keypad PIN* wall bracket can either be **screwed** or **adhered** directly to the wall.

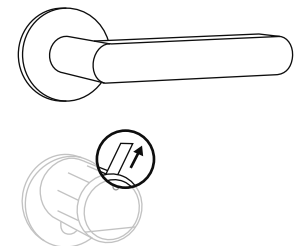
Prior to installation, please read the installation instructions carefully.

## ENTRY 7711 Keypad PIN installation - function test prior to installation

### ! ATTENTION:

The distance between the cylinder and the keypad can be up to a maximum of four metres. This distance may vary, however, depending on external conditions. In order to ensure that the keypad functions correctly in the desired position, we recommend testing it first **before installation**.

- 1 Place the keypad in the desired installation location (Fig. 105).
- 2 Enter your administrator or user code and check that the cylinder is activated (fig. 106).

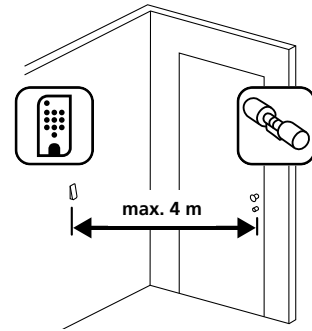

Fig. 105

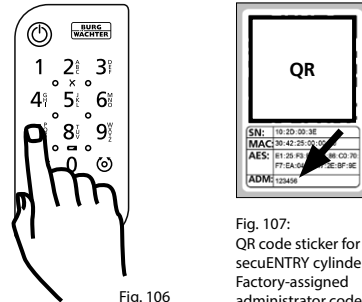

Fig. 106

Fig. 107:  
QR code sticker for  
secuENTRY cylinder  
Factory-assigned  
administrator code

**Note:** The administrator code, if you haven't already changed it, can be found on the sticker enclosed with the secuENTRY cylinder (Fig. 107). The master operating instructions for your secuENTRY cylinder describe how to create a user code.

If the cylinder activates, the signal strength is sufficient and the keypad can be installed in the desired location. If not, try again with a shorter distance between cylinder and keypad.

## ENTRY 7711 Keypad PIN installation - screw mounting

- 1 Drill three holes according to the dimensions shown in the illustration. Use a 6 mm diameter drill bit (Fig. 108).
- 2 Insert the dowels supplied into the holes and screw in the screws provided (Fig. 109).

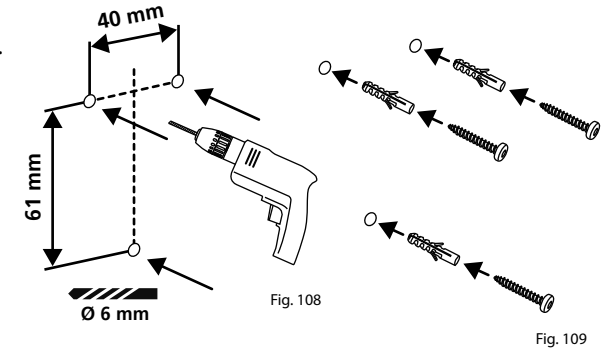

Fig. 108

Fig. 109

- 3 Remove the screw from the bottom of the keypad using the Tx8 screwdriver supplied with the keypad and pull the battery compartment downwards (Fig. 110).

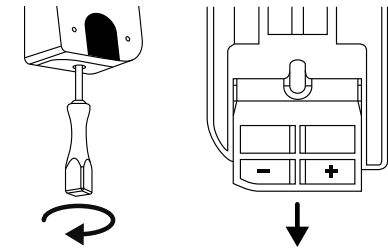

Fig. 110

- 4 Place the keypad on the screw heads as shown in the illustration (Fig. 111).

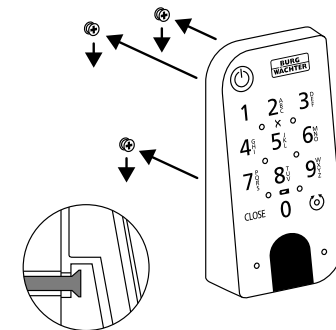

Fig. 111

- 5 Insert the battery compartment back into the housing and screw it tight (Fig. 112).

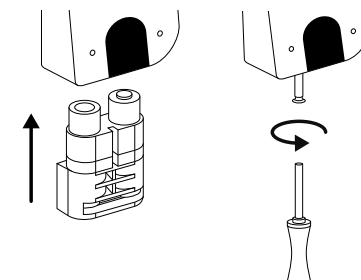

Fig. 112

## ENTRY 7711 Keypad PIN installation - adhesive mounting

- 1 Clean the surface to which the keypad is to be attached (Fig. 113).

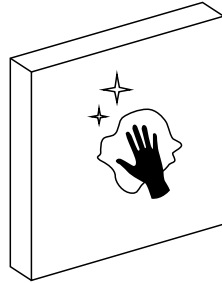

Fig. 113

- 2 Attach the enclosed adhesive pads to the positions shown in the illustration and peel off the backing strips (Fig. 114).

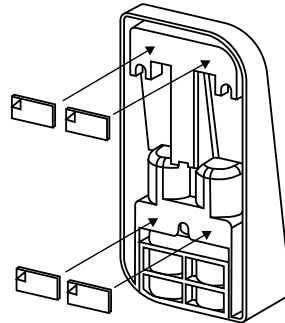

Fig. 114

- 3 Mount the keypad on the wall in the desired position (Fig. 115).

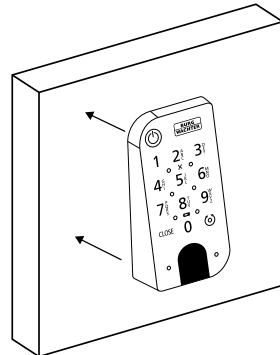

Fig. 115

- 4 Press the keypad against the wall for approx. one minute (Fig. 116).

- ! **Attention:** Only press the outer edges of the housing. To avoid damage to the electronics, do not press within the keypad area.

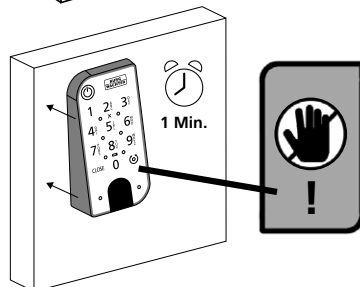

Fig. 116

## Battery status display and replacing the batteries

### ENTRY 5000 CYL cylinder

The battery status is shown on the display each time a secuENTRY cylinder is activated via the KeyApp (Fig. 117). When the batteries in the cylinder are running low, replace them as soon as possible.

- ! **Attention:** The batteries are located in the cylinder knob on the **inside** of the door. Please note that if you ignore the battery status and the battery is completely discharged, **you will no longer be able to open the lock from the outside.**

Instructions on replacing the batteries are given below:

- 1 On the inside of the door at the front end of the knob, remove the screw with the hexagonal spanner provided and remove the front cover (Fig. 118).
- 2 Remove the old batteries and dispose of them appropriately.
- ! **Tip:** Instructions for proper disposal can be found on page 17 of this manual.
- 3 Insert two new batteries. Make sure that the polarity is correct according to the drawing (Fig. 119).
- 4 Replace the front cover and screw it on tightly (Fig. 120).

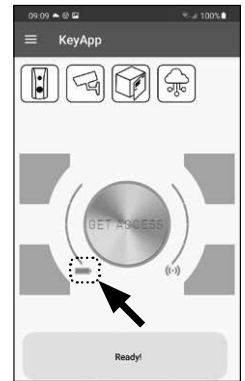

Fig. 117

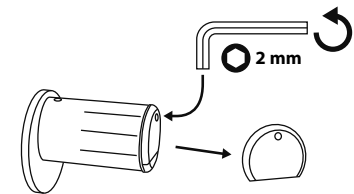

Fig. 118

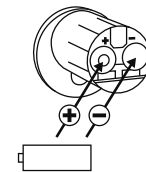

Fig. 119

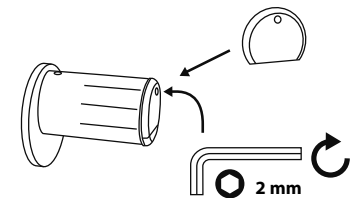

Fig. 120



## ENTRY 7711 Keypad PIN

The system monitors the keypad and cylinder battery voltage. The user is alerted as soon as the battery voltage reaches a critical range. Batteries must be changed as soon as possible after the battery status symbol illuminates on the keypad (Fig. 121).

**Tip:** It is recommended that the batteries in the cylinder and keypad are always replaced at the same time. Nonetheless, the battery status of the cylinder can be checked separately at any time. This can be found on the main screen of the secuENTRY KeyApp (Fig. 122).

Instructions on replacing the batteries are given below:

① Remove the screw from the bottom of the keypad using the Tx8 screwdriver supplied with the keypad and pull the battery compartment downwards (Fig. 123).

② Remove the old batteries and dispose of them appropriately.

**Tip:** Instructions for proper disposal can be found on page 17 of this manual.

③ Insert two new batteries. Make sure that the polarity is correct according to the drawing (Fig. 124).

Insert the battery compartment back into the housing and screw it tight (Fig. 124).

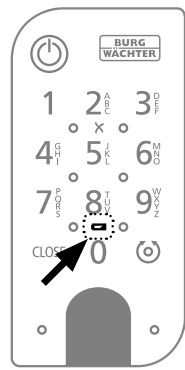

Fig. 121

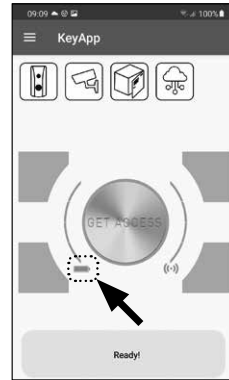

Fig. 122

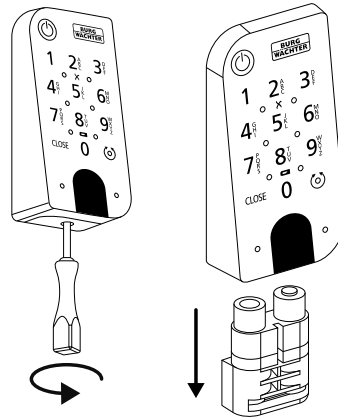

Fig. 123

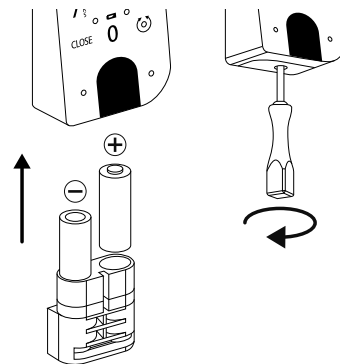

Fig. 124

## Compatibility with other secuENTRY products

Whether for one front door, several doors or a complete locking system: Simply configure your individual unit with the secuENTRY modular system .

Your ENTRY HOME 5001 PIN locking system can be extended with the following components:

### secuENTRY ENTRY sE-Key 7713



Fig. 125

The cylinder is opened simply by pressing a button using the ENTRY sE-Key 7713 radio key. The transmission is encrypted at a high security level (AES encryption).

**Article number:**  
4003482507131

**Further info available  
on our website:** [www.burg.biz](http://www.burg.biz)



## Warranty

In order to deliver a flawless and high quality product to you and to better assist you in case of service or repair, it is necessary that faulty or defective devices along with the valid administrator code and the QR code(s) be presented to your dealer together with the original documentation.

When returning goods due to your right of withdrawal, all parts of the appliance must also be in their factory settings. Failure to comply with this will invalidate the warranty.

## Disposal of the device

Dear customer,

Please help to reduce waste. Should you intend to dispose of this device at any time, please remember that many components of this device contain valuable materials that can be recycled.



Please note that electrical and electronic devices as well as batteries must not be disposed of with household waste but rather apart from it or separately. Please obtain information on the collecting points for electrical waste from the responsible authority of your city/municipality.



BURG-WÄCHTER KG hereby declares that this device complies with Directives 2014/53/EU, (RED) 2014/30/EU, (EMC) and 2011/65/EU (RoHS) .

The complete text of the EU Declaration of Conformity is available at the following Internet address: [www.burg.biz](http://www.burg.biz)

Printing and typesetting errors as well as technical changes reserved.



secuENTRY Set  
ENTRY Home 5001 PIN

**BURG-WÄCHTER KG**  
Altenhofer Weg 15  
58300 Wetter  
Germany  
[www.burg.biz](http://www.burg.biz)

BD Main Instruction Manual secuENTRY Set ENTRY 5001 PIN EN-HBG/SWI 150822

[www.burg.biz](http://www.burg.biz)