



Security Tech Germany

PPIC42520/ PPIC44520 PPIC42520B/ PPIC44520B



Instruction manual

Important information and FAQs about this product and other products can be found on the website

<http://www.abus.com/>

Version 1.1



*Original operating instructions in English language.
Keep for future use!*

Introduction

Dear customer,

Thank you for purchasing this product.

ABUS Security Center hereby declares that the PPIC42520, PPIC42520B, PPIC44520, PPIC44520B camera complies with the RED Directive 2014/53/EU. The devices also meet the requirements of the following EU directives: EMC Directive 2014/30/EU and RoHS Directive 2011/65/EU. The full text of the EU Declaration of Conformity is available at the following internet addresses:

<http://www.abus.com/product/PPIC42520>
<http://www.abus.com/product/PPIC42520B>
<http://www.abus.com/product/PPIC44520>
<http://www.abus.com/product/PPIC44520B>

In order to maintain this condition and to ensure safe operation, you as the user must observe these operating instructions!

Read through the complete operating instructions before using the product, observe all operating and safety instructions!

All company names and product designations contained herein are trademarks of their respective owners. All rights reserved.

If you have any questions, please contact your specialist dealer or visit us on the Internet at <https://www.abus.com/>.



Data storage is subject to country-specific data protection guidelines .

The commissioning of monitoring systems may be prohibited or regulated by law in certain countries. Before commissioning the system, the operator must ensure that the monitoring is within the legal framework.

Note on data protection

The operator is responsible for the legally compliant use of the product in accordance with the GDPR.



Warning:

Anyone who unauthorizedly records the non-publicly spoken word of another person on a sound carrier and uses such a recording or makes it available to a third party can be punished with imprisonment or a fine!

Similarly, an unauthorized person may be punished if he or she intercepts with a tapping device the non-publicly spoken word of another person which is not intended for his or her knowledge or if he or she communicates publicly, in full or in part, the recorded or intercepted non-publicly spoken word of another person.



Disclaimer

These operating instructions have been prepared with the utmost care. Should you nevertheless notice any omissions or inaccuracies, please let us know in writing at the above address.

ABUS Security Center GmbH accepts no liability whatsoever for technical and typographical errors and reserves the right to make changes to the product and operating instructions at any time without prior notice.

ABUS Security Center shall not be liable or responsible for any direct or indirect consequential damages in connection with the equipment, performance and use of this product. No guarantee is given for the content of this document.

The Purchaser acknowledges that, according to current technological standards, it is not possible to create a software program that is completely error-free. ABUS Security Center therefore does not guarantee uninterrupted or error-free operation of the products or the correction of all errors. ABUS Security Center expressly does not warrant that all ABUS Security Center products will function properly on all customer systems or in conjunction with integrations, solutions, applications and (or) programs, or that integrations, solutions, applications and (or) programs will function properly with later versions of ABUS Security Center products and systems.



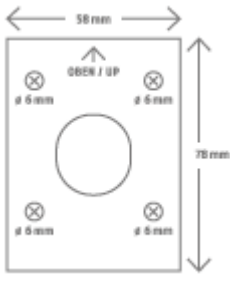



Table of contents

1. Scope of delivery	6
1.1. PPIC42520 / PPIC42520B	6
1.2. PPIC44520 / PPIC44520B	7
2. Hardware description	8
2.1. Wi-Fi Pan Tilt Outdoor Camera	8
2.2. Wi-Fi Outdoor Camera	10
3. Assembly / Installation	12
3.1. Camera mounting	12
3.1.1. Wi-Fi Pan Tilt Outdoor Camera (flush-mounted)	12
3.1.2. Wi-Fi Pan Tilt Outdoor Camera (Surface-Mounted)	13
3.1.3. WI-FI outdoor camera (flush-mounted)	14
3.1.4. Wi-Fi outdoor camera (surface-mounted)	15
3.2. Restore factory settings	17
3.2.1. PPIC42520 / PPIC42520B	17
3.2.2. PPIC44520 / PPIC44520B	17
3.3. Installation instructions Wi-Fi operation	18
3.4. Detection range of the camera	18
3.5. Installation site	18
4. Intelligent image analysis (object recognition)	19
4.1. Notes on object recognition	19
5. App2Cam Plus: First access	21
5.1. System requirements	21
5.2. Download app	21
5.3. Setup camera	22
5.3.1. Bluetooth setup	22
5.3.2. WI-FI setup	24
5.3.3. Setup via network cable	25
5.3.4. Add cameras that have already been set up	27
5.4. App2Cam Plus: Compatibility	28
5.5. App2Cam Plus: Overview	28
5.5.1. Menu bar	29
5.5.2. Camera bar	29
5.5.3. Info / App settings	29
5.6. App2Cam Plus: Live View	30
5.6.1. PPIC42520 / PPIC42520B Live View Functions	31
5.6.2. PPIC44520 / PPIC44520B Live View Functions	32
5.6.3. Camera indicators	32
5.6.4. Stream indicators	33
5.7. App2Cam Plus: Event list / playback	34
5.7.1. Event list	34
5.7.2. Event list functions	34
5.8. Playback	35

5.8.1. Playback functions	35
5.8.2. Download & Forwarding	36
5.9. Advanced settings	37
5.9.1. Open advanced settings	37
5.9.2. Login data.....	37
5.9.3. Automatic login	38
5.9.4. Advanced settings	38
5.9.5. Security settings	39
5.9.6. Video settings.....	40
5.9.7. Sound settings.....	43
5.9.8. WI-FI settings	44
5.9.9. Motion detection settings	45
5.9.10. Notification Settings	48
5.9.11. Memory settings	50
5.9.12. Schedule settings	52
5.9.13. Device settings	53
5.9.14. Device information.....	54
6. Update firmware	55
6.1. Updating via server	55
6.2. Current firmware version.....	56
7. Troubleshooting tips.....	57
8. Open Source License Notes.....	58

1. Scope of delivery



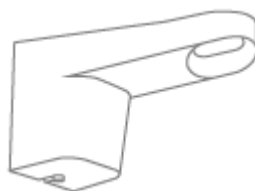



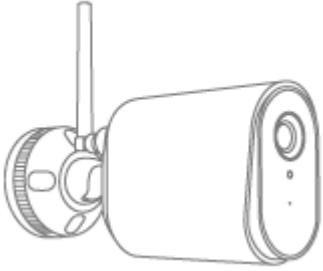

1.1. PPIC42520 / PPIC42520B

PPIC42520 / PPIC42520B			
1		2	
3		4	
5		6	
7		8	
9			

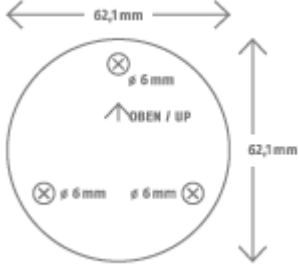
PPIC42520 / PPIC42520B

- Wi-Fi Pan Tilt Outdoor Camera (1)
- Power supply unit, 5V DC / 2A (2)
- Antenna (3)
- Drilling template (4)
- Mounting material (5)
- Reset tool (6)
- microSD card (pre-installed) (7)
- 2x Allen key (8)
- Wall bracket (pre-installed) (9)

1.2. PPIC44520 / PPIC44520B

PPIC44520 / PPIC44520B			
1		2	
3		4	
5		6	
7		8	
9			

PPIC44520 / PPIC44520B

- WI-FI Outdoor Camera (1)
- Power supply unit, 5V DV / 2A (2)
- Antenna (3)
- Drilling template (4)
- Mounting material (5)
- Reset tool (6)
- microSD card (pre-installed) (7)
- Allen key (8)
- Wall bracket (pre-installed) (9)

2. Hardware description

2.1. Wi-Fi Pan Tilt Outdoor Camera

Front

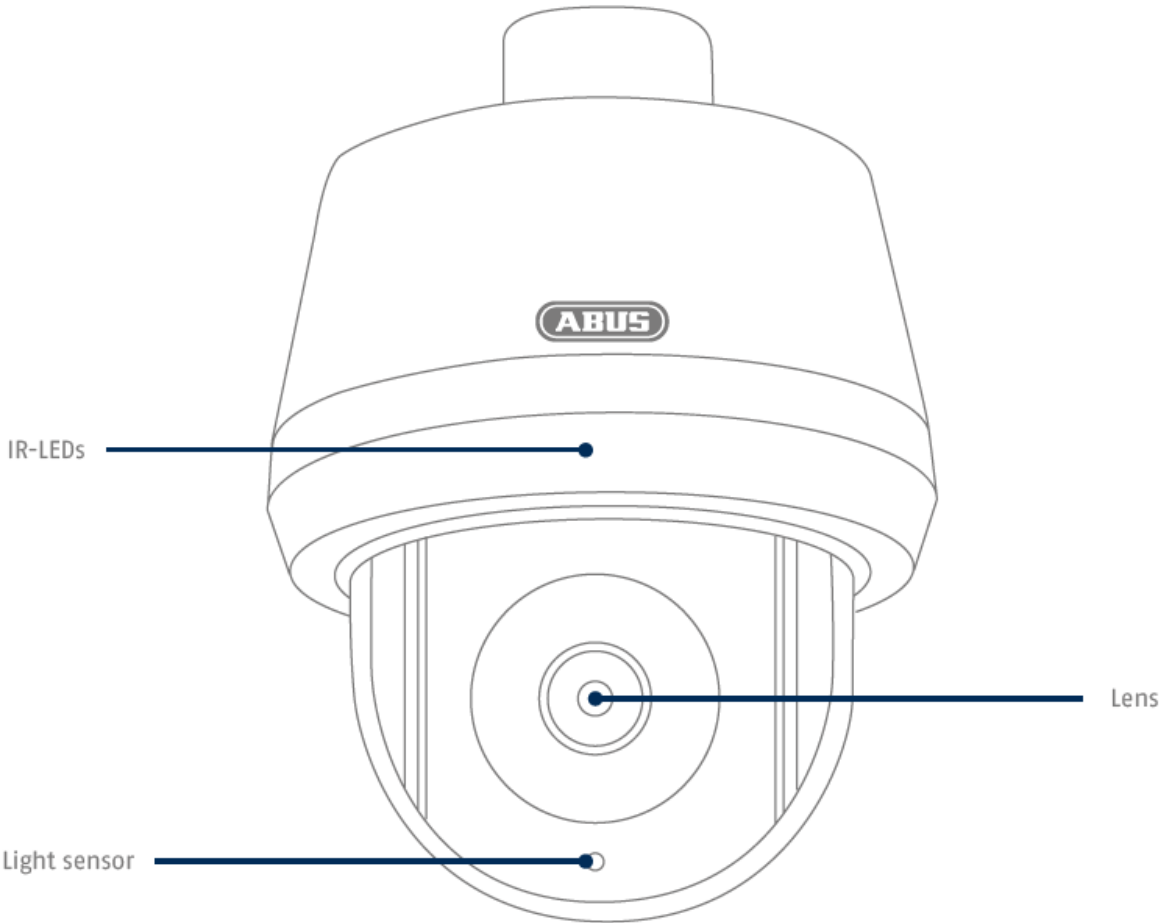

Rear

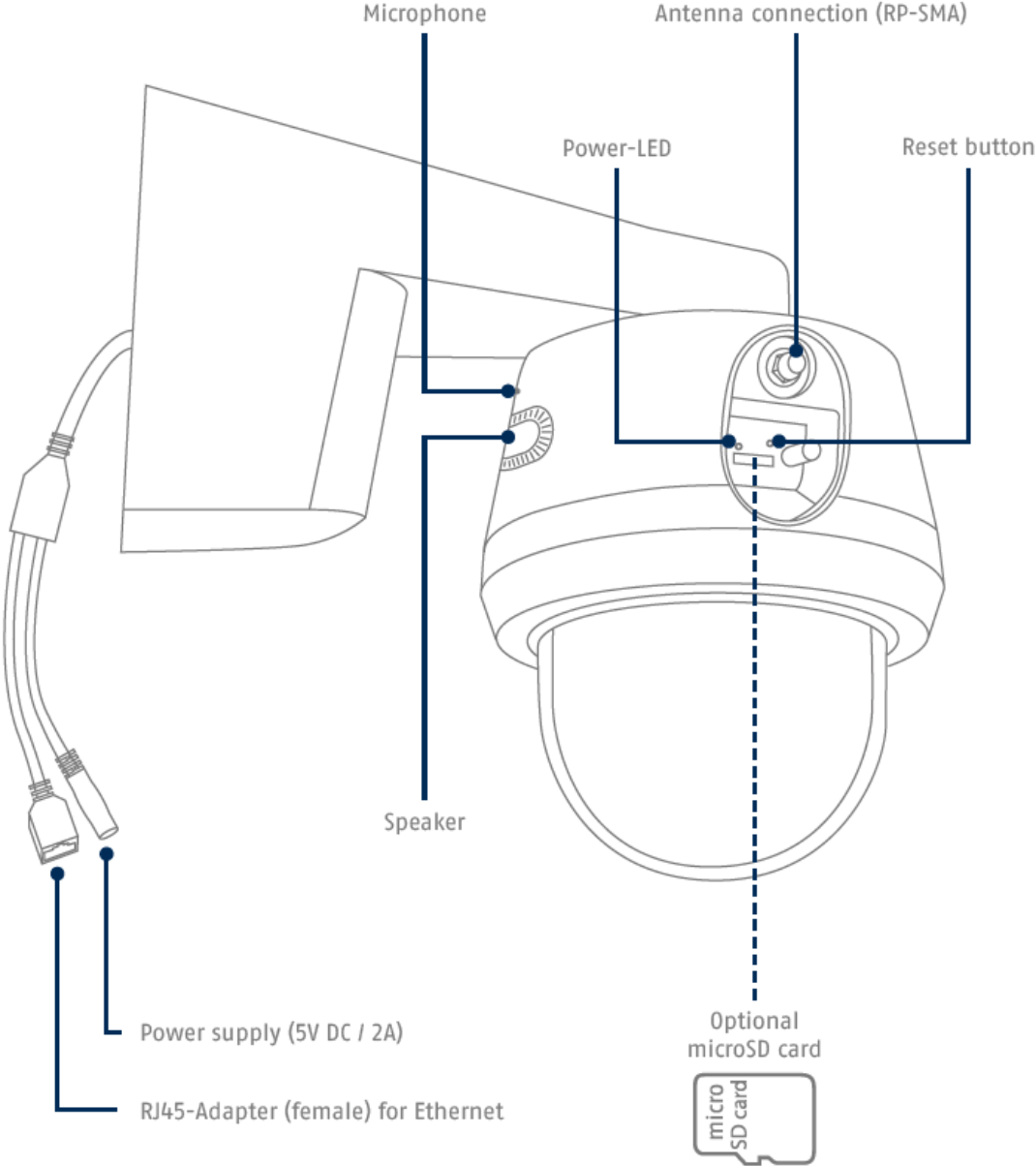

2.2. Wi-Fi Outdoor Camera

Front

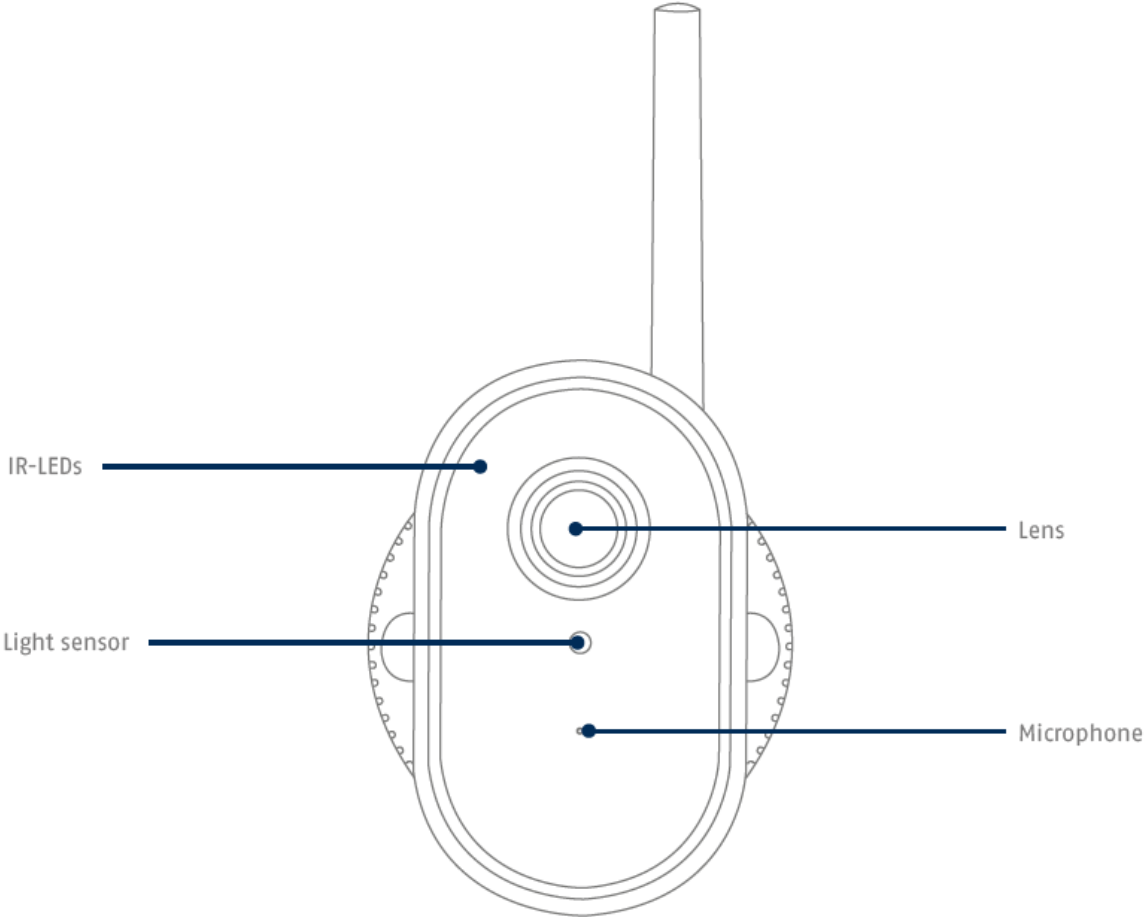

Rear

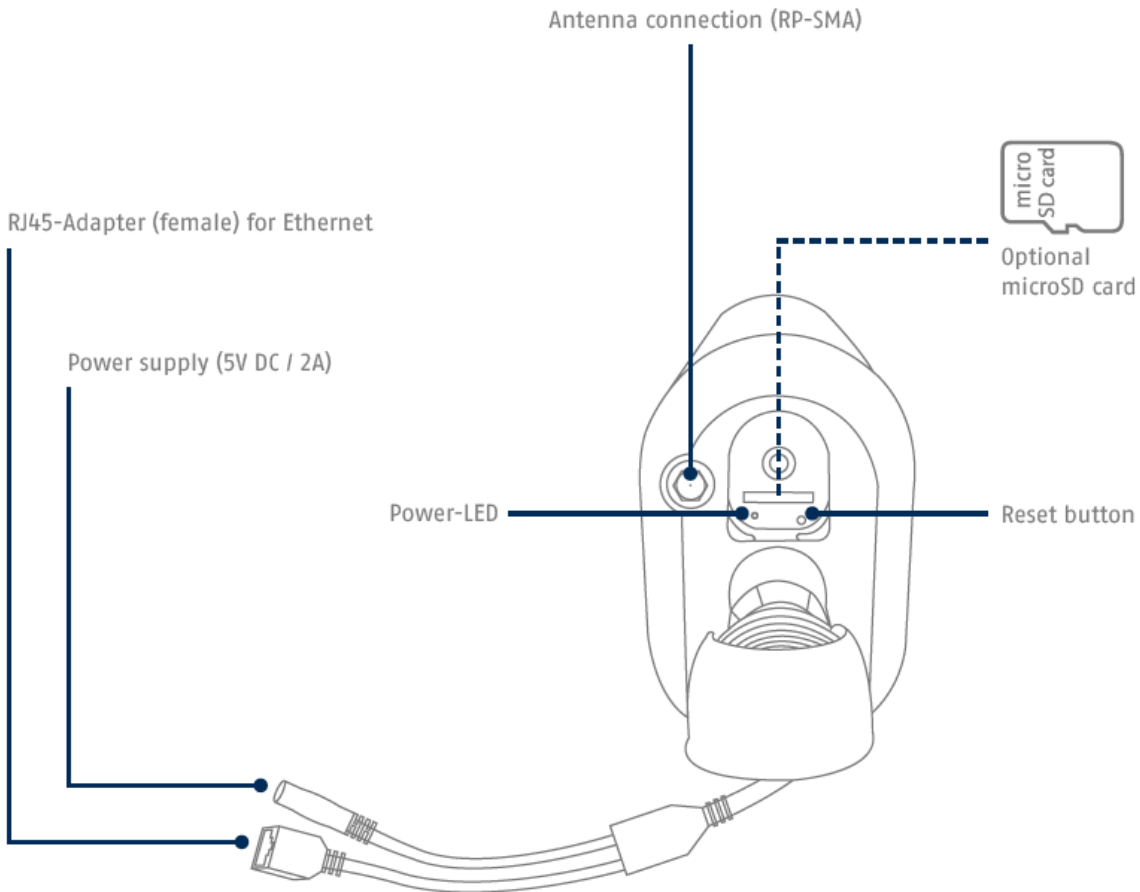

3. Assembly / Installation

	<p>ATTENTION! During installation, the camera must be disconnected from the mains voltage.</p>
--	---

	<p>Installation Site The camera is suitable for both outdoor and indoor use. Do not place the camera near heaters, stoves, other heat sources or in direct sunlight. Operate the device only in locations with temperatures within the permissible ambient temperature range of -20°~50°C.</p>
--	---

3.1.1. Wi-Fi Pan Tilt Outdoor Camera (flush-mounted)

During the installation of the camera, you have the option of accessing the following installation instructions via the help in the app.

	<p>Attention! Place the camera under a canopy or similar to avoid direct sunlight. The camera should not be pointed directly at a light source or at the sun.</p>
--	--

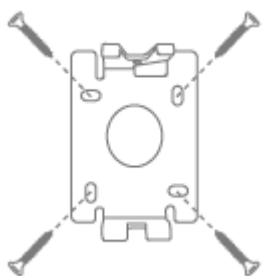

- Separate the wall plate of the bracket from the camera with the enclosed Allen key.
- Mark the position of the required 4 drill holes at the desired location using the drilling template or the wall plate and e.g. a pencil.
- Drill the holes and insert the enclosed dowels.
- Fasten the bracket with the enclosed screws.

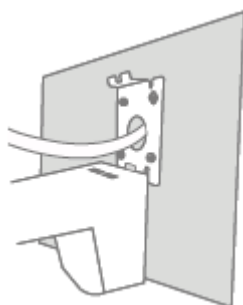

- The wall plate has a parking position at the bottom. Place the camera in the parking position so that you can do the wiring more easily.

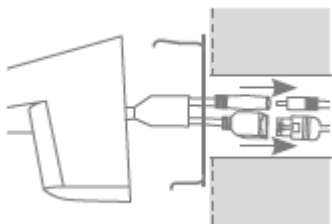

- Connect the power cable and LAN cable (optional for Wi-Fi use) to the connectors on the camera.
- Guide the cables into the wall. The connections can also be stowed in the bracket as an option.



- Place the camera and bracket completely on the wall plate and fix the elements to the underside of the bracket with the Allen key.
- With this installation, the cables run completely inside the bracket and are now no longer visible.

3.1.2. Wi-Fi Pan Tilt Outdoor Camera (Surface-Mounted)

During the installation of the camera, you have the option of accessing the following installation instructions via the help in the app.



Attention!

Place the camera under a canopy or similar to avoid direct sunlight. The camera should not be pointed directly at a light source or at the sun.

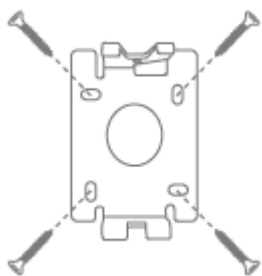

- Separate the wall plate of the bracket from the camera with the enclosed Allen key.
- Mark the position of the required 4 drill holes at the desired location using the drilling template or the wall plate and e.g. a pencil.
- Drill the holes and insert the enclosed dowels.
- Fasten the bracket with the enclosed screws.

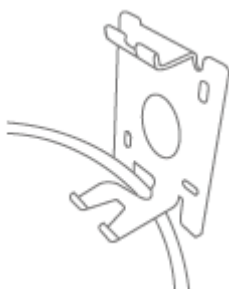

- Feed the camera's power cable through the bracket and down as shown in the illustration.



- Place the camera and bracket completely on the wall plate and fix the elements to the underside of the bracket with the Allen key.

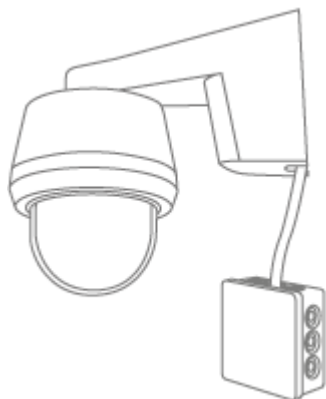

- Use a commercially available weather-protected installation box (width and height min. 105 mm, depth min. 35 mm) for a waterproof installation.
- Guide the cable of the camera into the installation box and carry out the wiring there. For further installation with an installation box, follow the installation instructions for this box.

3.1.3. WI-FI outdoor camera (flush-mounted)

During the installation of the camera, you have the option of accessing the following installation instructions via the help in the app.



Attention!

Place the camera under a canopy or similar to avoid direct sunlight. The camera should not be pointed directly at a light source or at the sun.



- Mark the position of the required 3 drill holes at the desired location using the drilling template or the wall plate of the bracket and, for example, a pencil. To do this, please unscrew the bracket.
- Drill the holes and insert the enclosed dowels.

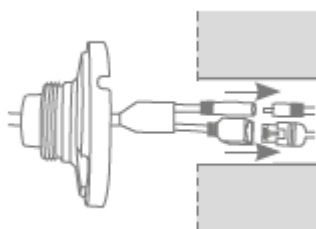

- Connect the power cable and LAN cable (optional for Wi-Fi use) to the 2 connectors on the camera.
- Guide the cables into the wall.



- Fix the wall plate of the bracket with the enclosed screws.

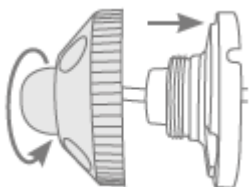

- Insert the ball joint and put on the cover.
- Afterwards, the fixing ring is slightly screwed on.

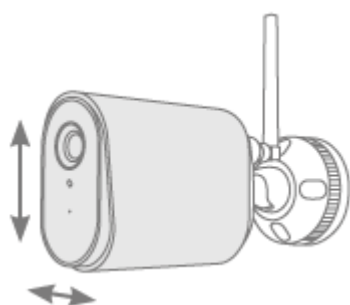

- Now align the camera to the roughly desired coverage area and tighten the fixing ring.
- Place the antenna on the connector and screw it tight.

3.1.4. Wi-Fi outdoor camera (surface-mounted)

During the installation of the camera, you have the option of accessing the following installation instructions via the help in the app.



Attention!

Place the camera under a canopy or similar to avoid direct sunlight. The camera should not be pointed directly at a light source or at the sun.

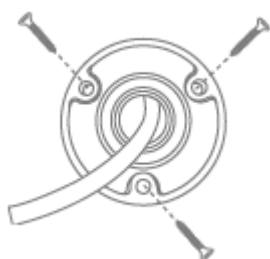

Mark the desired place of use using the drilling template or the wall plate of the bracket and use a pencil, for example, to determine the position of the 3 drill holes required. To do this, please unscrew the bracket.

- Drill the holes and insert the enclosed dowels.
- Guide the cable through one of the recesses in the wall plate
- Fix the wall plate of the bracket with the enclosed screws.

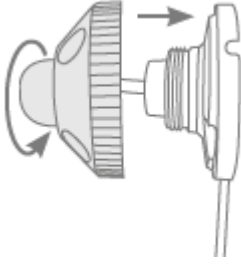

- Insert the ball joint and put on the cover.
- The fixing ring is then screwed on a little.

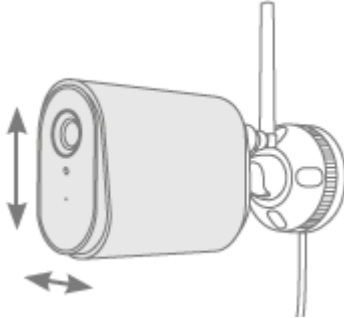

- Now align the camera to the roughly desired coverage area and tighten the fixing ring.
- Place the antenna on the connector and screw it tight.

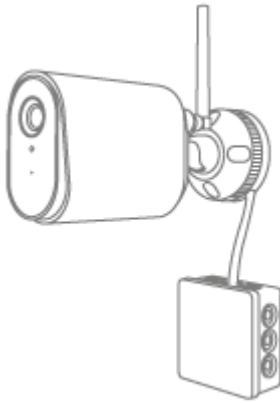

- Use a commercially available weather-protected installation box (width and height min. 105 mm, depth min. 35 mm) for a waterproof installation.
- Guide the cable of the camera into the installation box and carry out the wiring there. For further installation with an installation box, follow the installation instructions for this box.

3.2. Restore factory settings

3.2.1. PPIC42520 / PPIC42520B

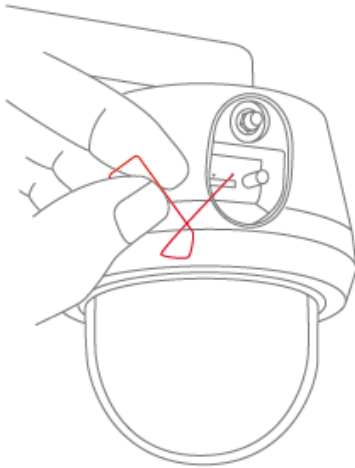

If there are difficulties during setup or you have forgotten the access data (security code or admin password), reset the camera to factory settings:

Open the cover on the back of the camera using an Allen key and press the reset button for at least 3 seconds using a thin object (e.g. the microSD card removal tool or a paper clip) until the power LED flashes.

3.2.2. PPIC44520 / PPIC44520B

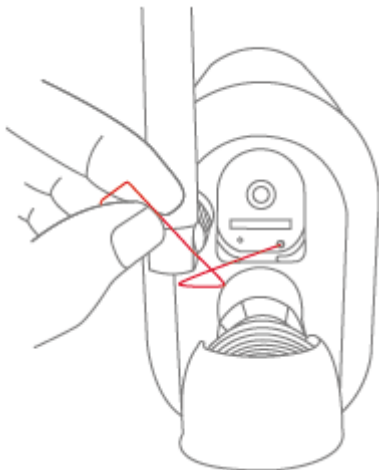

If there are difficulties during setup or you have forgotten the access data (security code or admin password), reset the camera to factory settings:

Open the cover on the back of the camera using an Allen key and press the reset button for at least 3 seconds using a thin object (e.g. the microSD card removal tool or a paper clip) until the power LED flashes.

3.3. Installation instructions Wi-Fi operation

When installing the camera, make sure that it is within optimal range of the router. The camera can only be accessed if there is a sufficient Wi-Fi signal to the router.

For installations in larger objects, a Wi-Fi repeater is recommended to optimize the range. Optionally, you can also operate the camera via LAN.

Please note that structural conditions can influence the transmission.

	<p>Note</p> <p>You can obtain information about compatible Wi-Fi repeaters from your network operator or the manufacturer of your router. ABUS Security Center GmbH & Co KG will not make any recommendations for Wi-Fi repeaters.</p> <p>Pay close attention to the installation recommendations of the Wi-Fi repeater. The positioning should ideally be between the router and the camera.</p>
---	--

3.4. Detection range of the camera

With intelligent object detection, the detection range of the camera is based on the selected object. If the object is outside this range, it can be "seen" by the camera and displayed on the live image, but it does not trigger a recording.

Intelligent Object Detection works reliably over the following range, outside these specified ranges motion detection may occur but is not guaranteed.

Object type	Max. Range
Person	8 - 10 metres*
Animal	3 - 4 metres
Vehicle	10 - 15 metres

Range is based on a person of approx. 1.80 m height.

	<p>Note</p> <p>The reliability of object detection depends on local factors. In some situations, false alarms may still occur. Environmental influences such as rain, snow, insects, or dirt can have a negative effect on the results.</p>
---	--

3.5. Installation site

The camera with protection class IP66 is suitable for outdoor use. The setup process for the app is described under 5. App2Cam Plus: First Access. For external access to the camera, you need a router with Internet access.

	<p>Note</p> <p>Place the camera so that it is not covered by objects. If possible, place the camera under a canopy or similar to avoid direct sunlight. The camera should not be pointed directly at a light source or at the sun.</p>
---	---

4. Intelligent image analysis (object recognition)

4.1. Notes on object recognition

Intelligent object detection allows you to differentiate between different types of objects (human, animal, car) during an object detection. This gives you the option, for example, of not triggering objects at all or triggering them with a lower priority.

Please note that object detection depends on distance, viewing angle and object size (seen from camera to object). Please read the section "4.2 Detection range of the camera".

	<p>Note</p> <p>Intelligent object detection is used to significantly reduce false alarms compared to traditional methods of motion detection. Traditional methods are, for example, motion detection via heat radiation by PIR sensors or classic software motion detection without object detection, which only takes into account the object size but not the object type.</p> <p>It always requires environment-dependent individual fine-tuning of sensitivity and the use of blanked areas to achieve maximum accuracy, but 100% accuracy and the complete exclusion of false alarms is not possible.</p>
---	--

Vehicles that are in the parking position do not trigger recordings until the vehicle is moving again or there is movement in the image.

In the case of animal and person detection, a recording is triggered even if they are not moving. If a mannequin or a picture with people is visible in the recording area, for example, please hide this area.

	<p>Note</p> <p>When recognizing animals, the algorithm checks for the presence of 4 legs. The main target group of animals to be recognized are dogs and cats.</p>
---	---

If several objects are detected in the image at the same time, the object detected first is always displayed in the event list.

For example, if a vehicle enters the driveway, the event list will show the vehicle as the trigger, even if a person leaves the car in the video sequence.

The person is nevertheless marked with a colored recognition frame in the video.

Please note that object recognition searches for specific characteristics of an object in the image, but these can be falsified by environmental influences such as wind, rain, snow, or insects. Therefore, there is always a residual risk that an object will be wrongly classified. For example, in a person recognition system, objects that look similar to the outline of a person can also be detected as a person. An example could be a flag that is moving in the wind and in this case could be recognized as a person in a mackintosh.



To exclude areas that are particularly susceptible to interference from detection, you can set a hidden area (RONI - Region Of No Interest) here. The area is still visible, but no object detection takes place here and therefore no push message and recording.

In case of frequent false triggers caused by objects, it is advisable to adjust the sensitivity of the objects. Often these are already avoided at a lower level.

You can fine-tune the sensitivity of the detectors using the sliders, with the value 1 representing the lowest sensitivity and the value 10 the highest sensitivity of detection.

So with a value of 1, a person is only reported if it is very likely really a person.

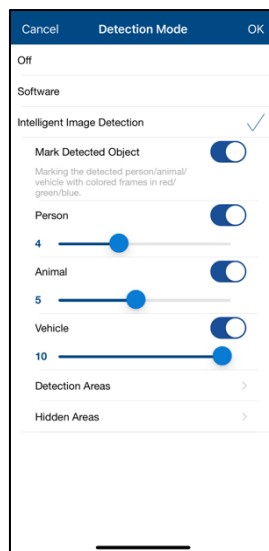

The following settings are recommended for the various objects:

Person: Level 2

Animal: Level 3

Vehicle: Level 10



Note

The reliability of object detection depends on local factors. In various situations, false alarms can occur. In particular, environmental influences such as rain, snow, insects, dirt and difficult lighting conditions can have a negative effect on the results.

5. App2Cam Plus: First access

5.1. System requirements

Please note the following points to ensure easy setup:

- 2.4 or 5GHz Wi-Fi network with password and encryption.
- The location service of the mobile device must be activated for network integration.
- Bluetooth of the mobile device must be activated.
- Network integration can only be carried out in conjunction with the App2Cam Plus.
- When entering the Wi-Fi password, the following special characters are not possible.

&	`
---	---

- When entering the Wi-Fi password, only the following special characters are possible.

“	*	\$:	<	>	^
,	;		()	{	}
!]	+	-	=	@	~
[?	/	%	_	#	.

5.2. Download app

Download the app "App2Cam Plus" from the Google Playstore or Apple Appstore for the first access.



During the installation, help pages are available for the various steps. Click on the  icon to access the help pages.

5.3. Setup camera

5.3.1. Bluetooth setup

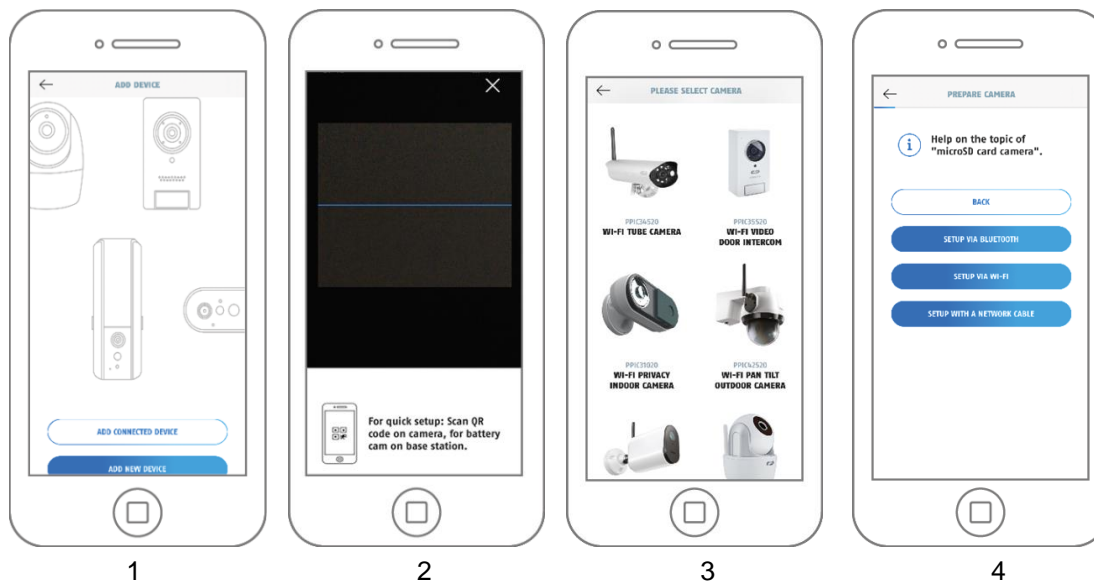

1. Start the App2Cam Plus and select "Add new device" to start the setup.
2. Option 1: Scan the QR code on the back of the camera.
3. Option 2: Select your camera model.
4. Select "Setup via Bluetooth".



Note

For optimal start-up, the camera and the smartphone/tablet must be as close to each other as possible, at a maximum distance of 3 metres.

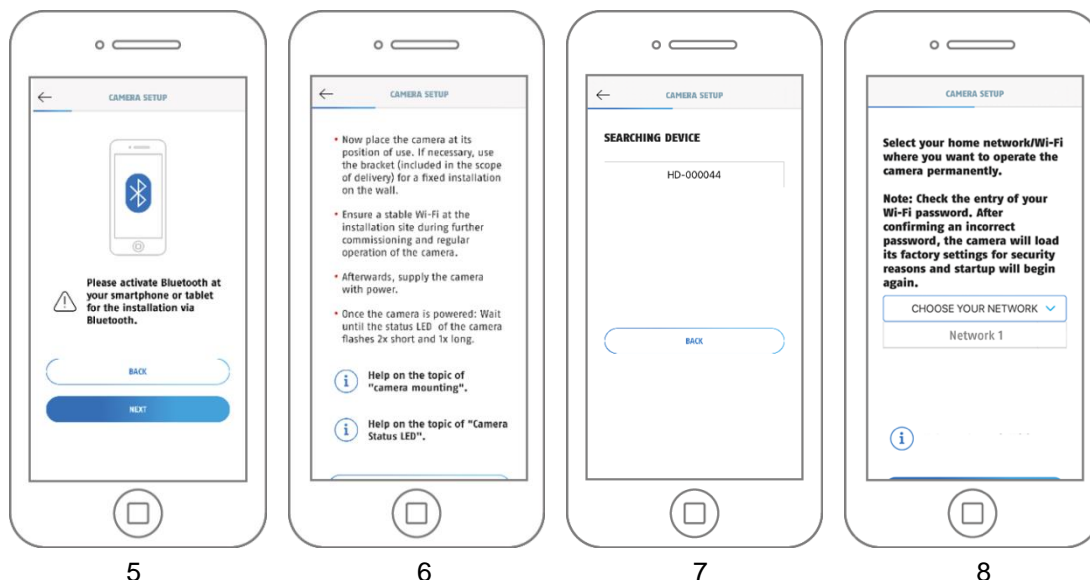

5. If you have not already done so: Activate Bluetooth in the settings of the mobile device. Then tap on "Next".
6. Now supply the camera with power and wait 2 minutes until the camera has started. Then tap on "Next".

7. Select your camera using the identification number. You will find the identification number (DID) of your camera under the QR code that is on your camera and also enclosed in the packaging. Then tap on "Next".
8. Select your home network/Wi-Fi in which you want to operate the camera permanently. Then tap on "Next".

**Note**

For optimal setup, the location services must be activated in the settings.

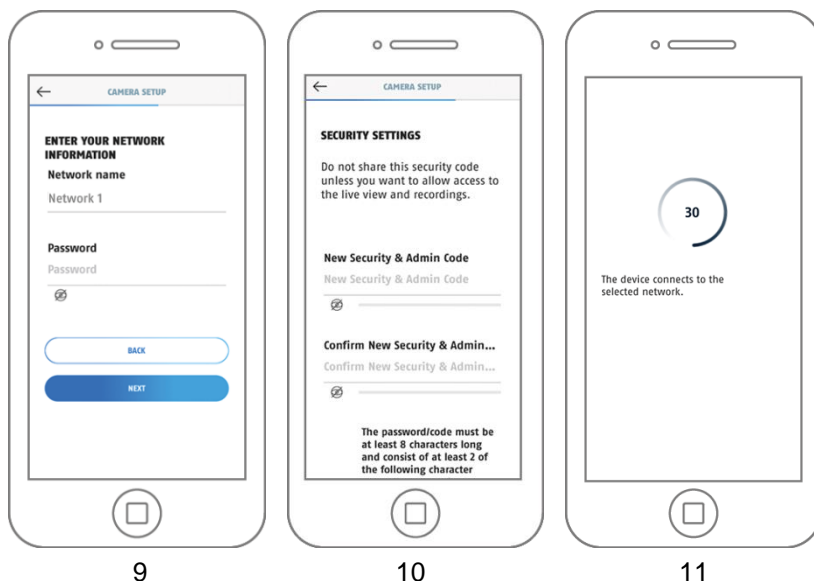

9

10

11

9. Enter the password of your network. Then tap on "Next".
10. Now assign a security code or admin password. These must be identical when setting up via Bluetooth. Then tap on "Next".
11. The camera will now restart. If the start-up was successful up to this point, the app displays the camera's item number in the "Overview" screen. This can take up to 120 seconds.
12. You have successfully completed the setup. All settings and functions can be accessed via the menu bar at the bottom of the screen.
13. If the Bluetooth setup was not successful, you can alternatively use the installation via WI-FI or network cable.

**Note**

For the best possible camera experience, we recommend that you always operate the camera with the latest firmware. You can find the current firmware version and available updates under "Advanced options" > "Device settings".

5.3.2. WI-FI setup

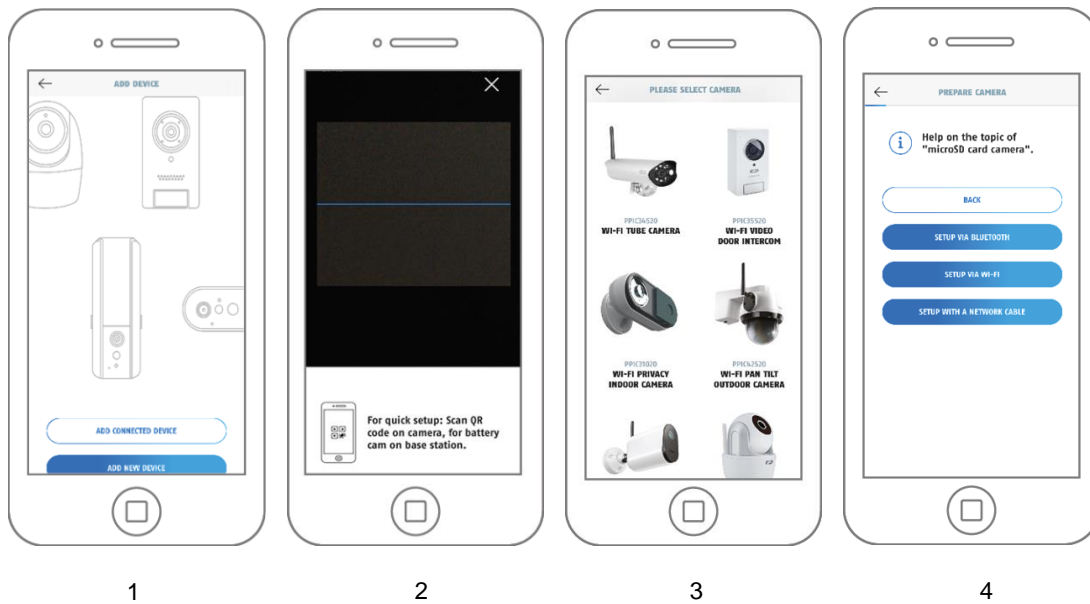

1. Start the App2Cam Plus and select "Add new device" to start the setup.
2. Option 1: Scan the QR code on the back of the camera.
3. Option 2: Select your camera model.
4. Select "Setup via WI-FI".

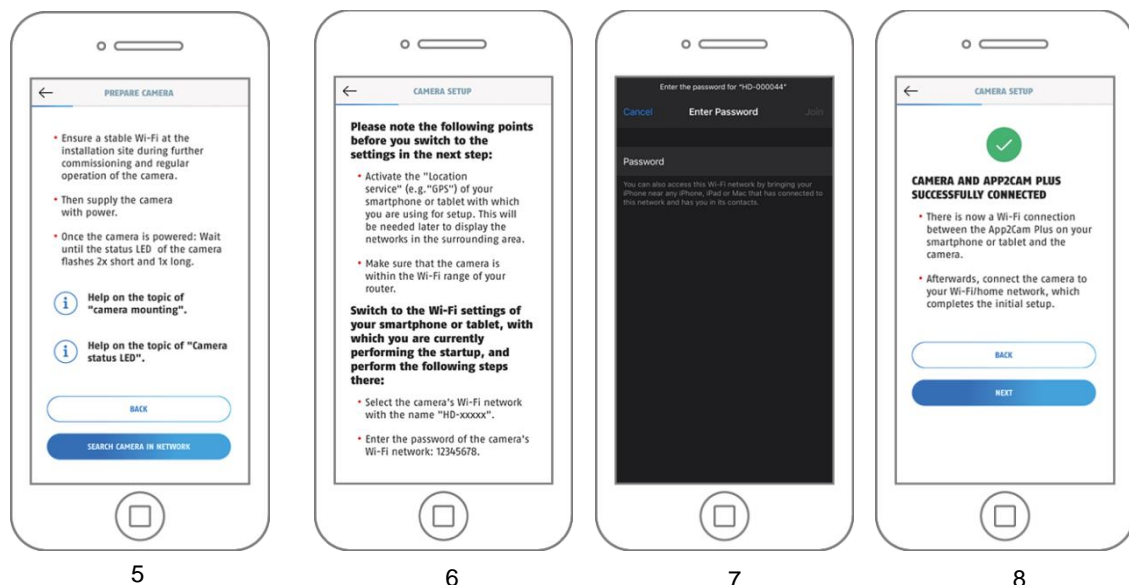

5. Supply the camera with power and then click on "Search camera in network".
6. Click on "Switch to WI-FI settings".
7. Connect to the WI-FI access point of the camera. You can recognize this by the name "HD-XXXXXX". The password for the camera's WI-FI access point is: "12345678".
8. Switch back to the App2Cam Plus app and click on "Next".

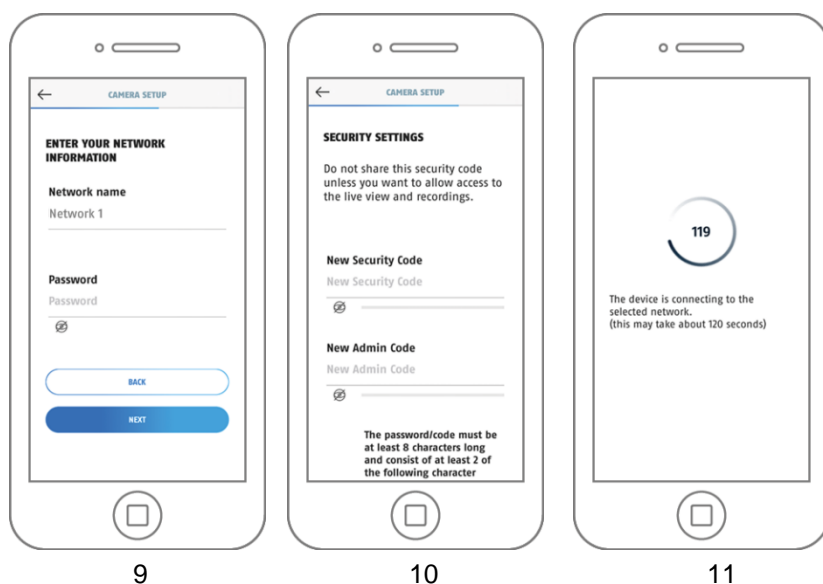

9. Enter the password of your network. Then tap on "Next".
10. Now assign a security code or admin password. These must not be identical when setting up via WI-FI. Then tap on "Next".
11. The camera will now restart. If the setup was successful up to this point, the app displays the camera's item number in the "Overview" screen. This can take up to 120 seconds.
12. You have successfully completed the setup. All settings and functions can be accessed via the menu bar at the bottom of the screen.

	<p>Note</p> <p>For the best possible camera experience, we recommend that you always operate the camera with the latest firmware. You can find the current firmware version and available updates under "Advanced options" > "Device settings".</p>
---	---

5.3.3. Setup via network cable

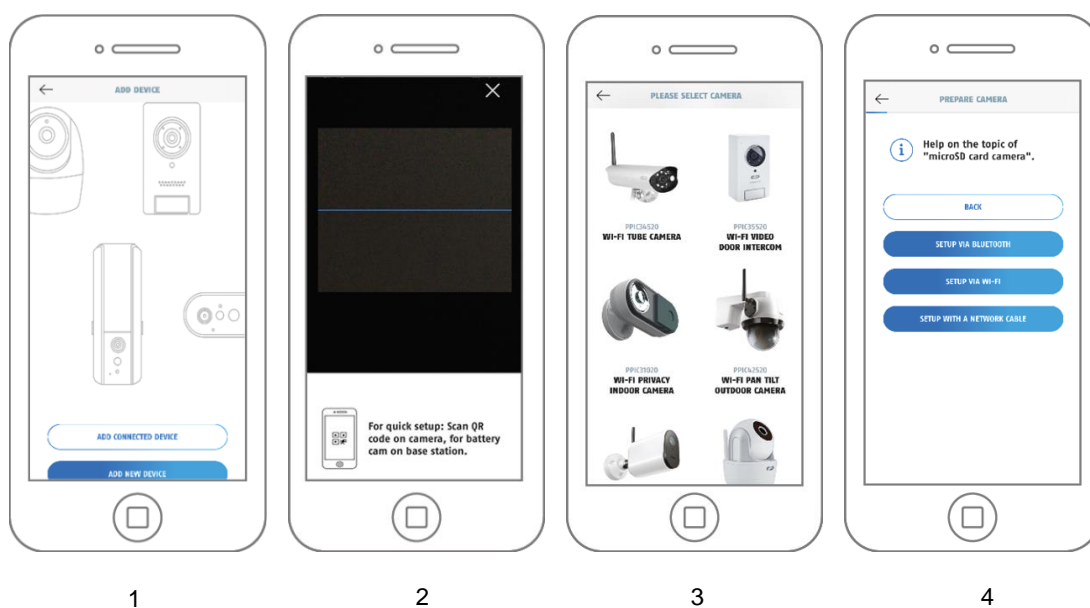

1. Start the App2Cam Plus and select "Add new device" to start the setup.
2. Option 1: Scan the QR code on the back of the camera.

3. Option 2: Select your camera model.
4. Select "Setup with a network cable".

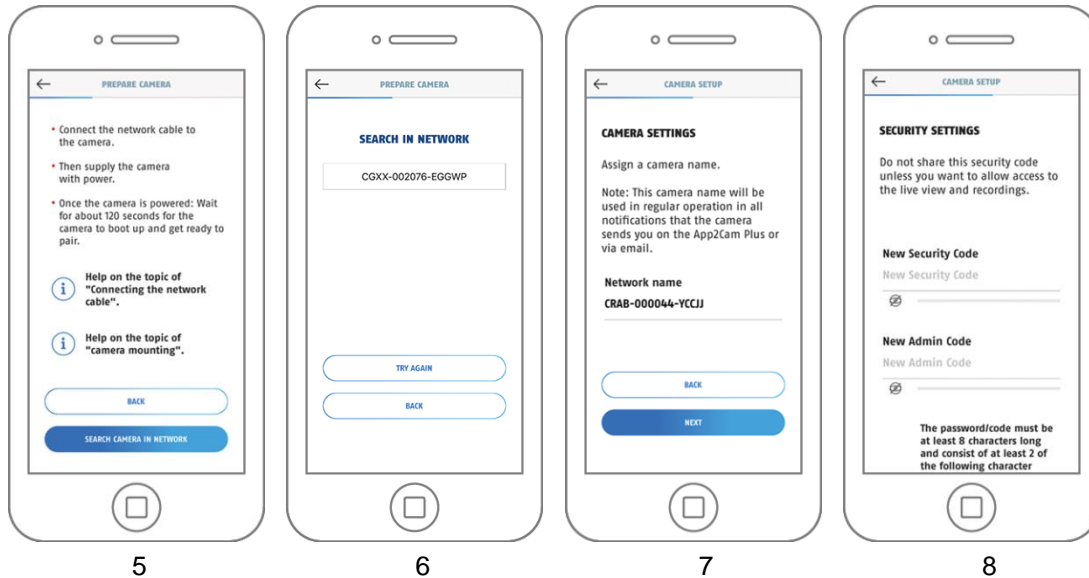

5. Now connect the network cable and supply the camera with power. Click on "Search camera in network".
6. Next, click on the camera identification number (DID) of your camera.
7. Assign a camera name.
8. Now assign a security code or admin password. These must not be identical. Then tap on "Next".
9. You have successfully completed the commissioning. All settings and functions can be accessed via the menu bar at the bottom of the screen.

5.3.4. Add cameras that have already been set up

To setup a camera that is already connected to the network, please proceed as follows.

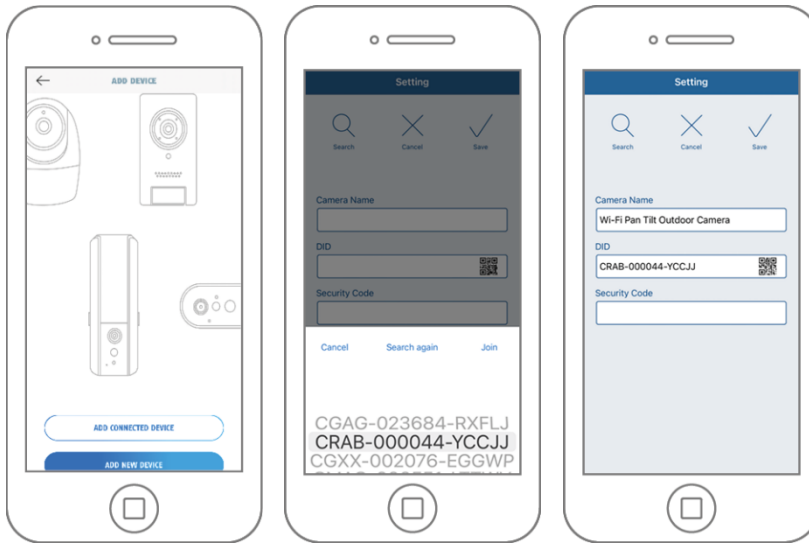

Open the app and click on the "+" to add a camera, click on "Add connected device".

Enter a name for your camera. To enter the DID you have the following options, scan the QR code on the back of the camera, search for the camera in the network with the "Search" button or enter the DID of the camera manually.

The default security code of the camera is "123456". If the camera has already been set up, enter the security code assigned to the camera.

Press the "Save" button to add the camera.

You have successfully completed the setup. All settings and functions can be accessed via the menu bar at the bottom of the screen.



Note

If a camera has already been set up via another smartphone or user, select this method to add cameras that have already been set up.

5.4. App2Cam Plus: Compatibility

The App2Cam Plus is compatible with the following devices:

- PPIC90000 / PPIC90010 / PPIC90200
- PPIC32020 / PPIC32520 / PPIC34520
- PPIC35520 / PPIC36520
- PPIC42520 / PPIC42520B / PPIC44520 / PPIC44520B
- TVAC19000A-B / TVAC19100A-B
- TVAC16000/TVAC16001



Note

Please note that some functions explained or shown in this manual may not be compatible with older generation cameras or the functionalities of the cameras may differ due to hardware differences.

5.5. App2Cam Plus: Overview



Note

The screenshots and icons shown were taken from the iOS app. There may be slight deviations from the Android app in the labelling, arrangement or functionality. This is described in the respective points or mentioned with an addition (iOS only) or (Android only).

In the overview, you can open the live view of the camera by clicking on one of the preview images. You can use further functions in the menu bar, camera bar and in the Info / App setting.

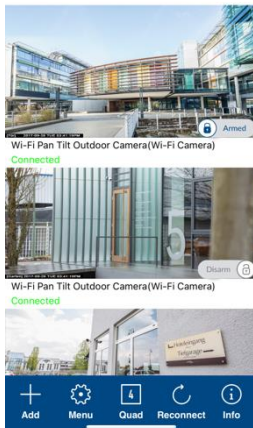

Menu bar

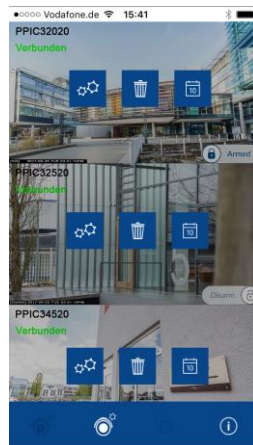



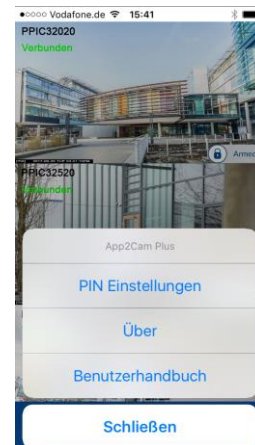



Camera bar







App Settings / Info

5.5.1. Menu bar

	
	Set up new camera / Add camera
	Activate / deactivate camera bar
	Activation of the quad view
	Connection update Updating the connections to the cameras
	Info / Open app settings

5.5.2. Camera bar

	
	Open the camera settings
	Delete device
	Open event list

5.5.3. Info / App settings

PIN settings	App pin Menu for assigning an app pin. If activated and assigned, this is requested each time the app is started.
About	About Find out about the current app version, privacy policy and API version here.
User manual / Instructions	Instructions Call up the product page of the selected camera here. Here you can download the instructions in the download sector.
Video acceleration (Android only)	Enable/disable hardware decoding For Android, the use of hardware decoding is available. Some Android devices have special hardware features that optimize the decoding of video streams. For older products or older Android devices, this can lead to a deterioration in performance.
Notify (Android only)	Activation / deactivation of push notifications
Rate Me!	App rating Rate our app and send us your suggestions for improvement.

5.6. App2Cam Plus: Live View

Various functions are available in the live view depending on the camera model. The functions are additionally available in landscape mode. Click on the preview image of the camera to access the live view.

During initial installation, the factory security code must be changed.

It is recommended to use a combination of numbers as well as lower- and upper-case letters and special characters.

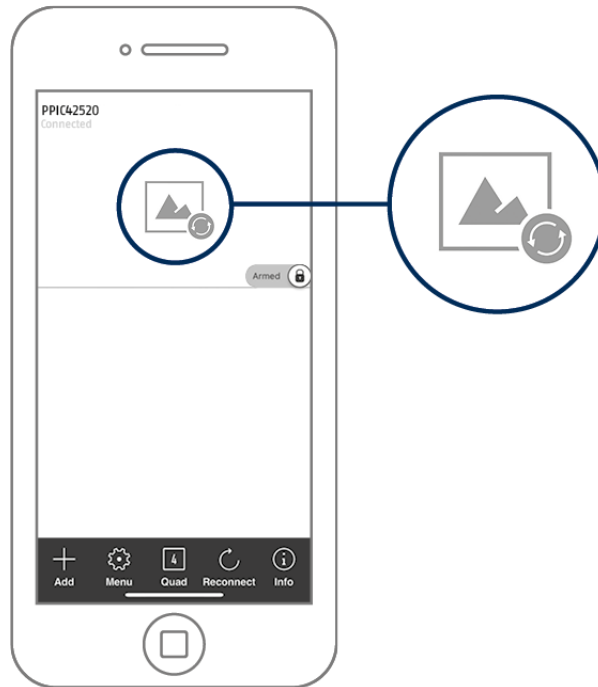

5.6.1. PPIC42520 / PPIC42520B Live View Functions



Intercom function
 You can use the microphone of the mobile end device to communicate through the camera intercom. Press and hold the symbol in order to activate the intercom function. The transmission is deactivated as soon as you release the symbol.

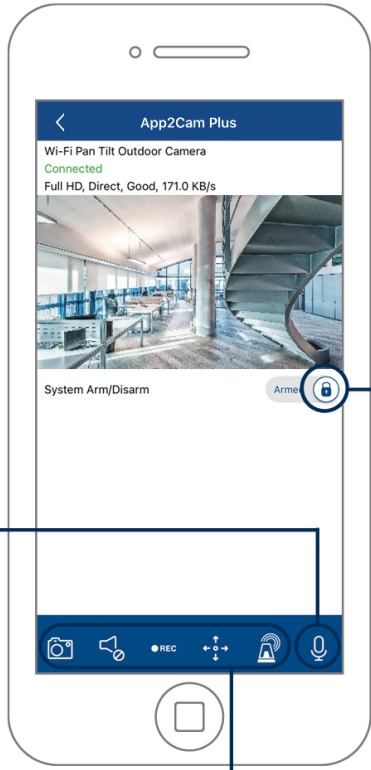

Alarm is active
 The camera records when motion is detected and sends notifications (push or e-mail).



Alarm is deactivated
 The camera displays a live view but does not carry out any other actions when motion is detected.



Create a screenshot



Enable/disable audio output



Start manual recording



Pan/tilt
 Open the menu



Activate/deactivate siren

Pan/Tilt function

For pan/tilt cameras, you can either use a "swipe" command to control the camera or press and release a point for a longer time to control the camera to the pressed point.

When entering the live image, the starting position is always displayed.

Pan/Tilt Menu

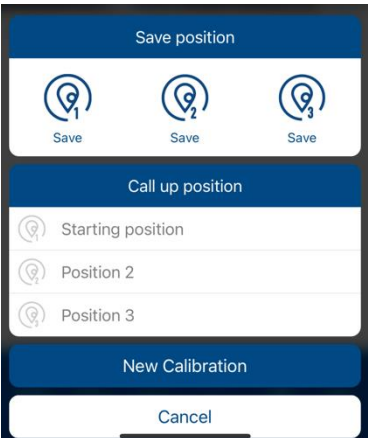

	Save or recall initial position
	Save or recall item 2
	Save or recall item 3
Calibration	Camera calibrates itself
Cancel	Cancel

5.6.2. PPIC44520 / PPIC44520B Live View Functions

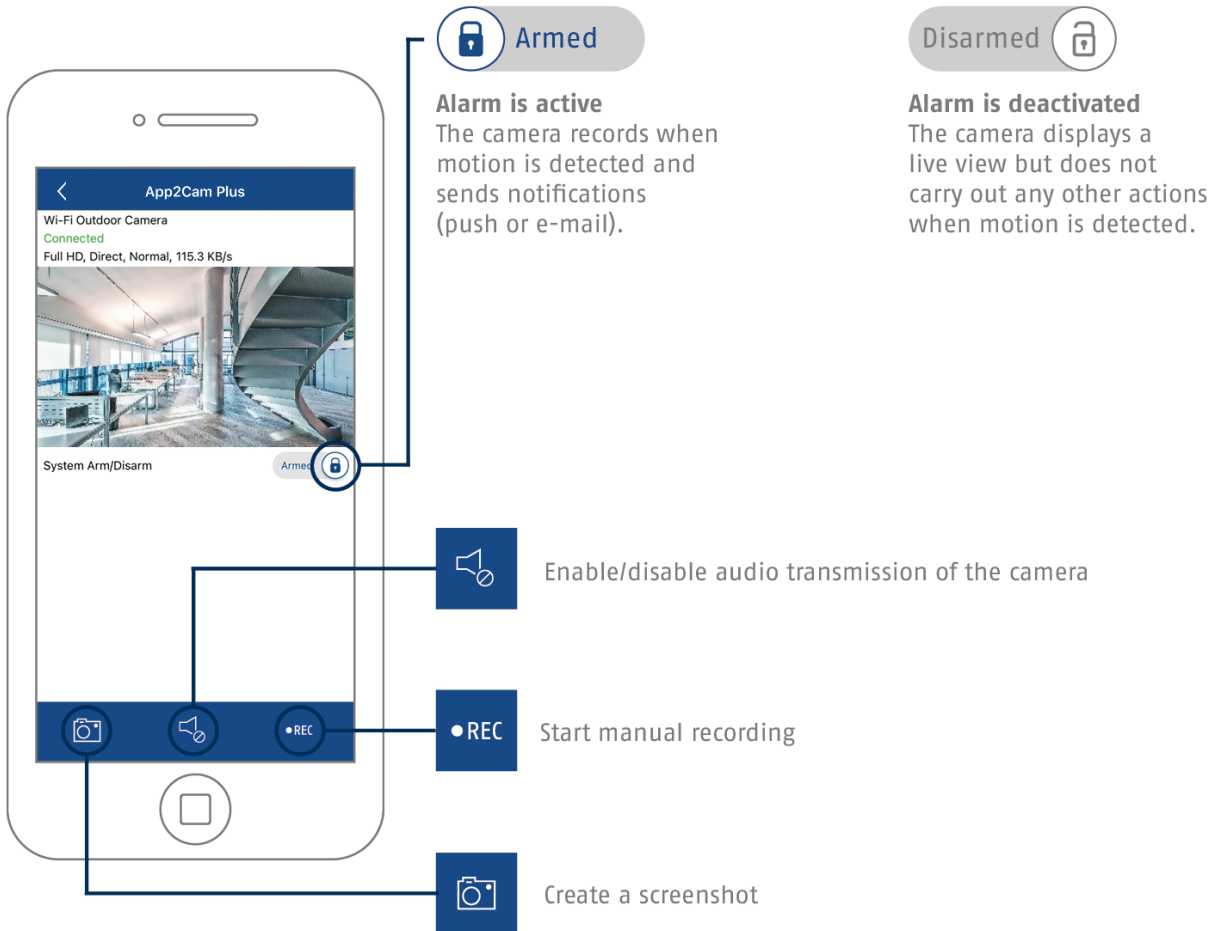

5.6.3. Camera indicators

Wi-Fi Pan Tilt Outdoor Camera Connected Full HD, Direct, Good, 171.0 KB/s	
Wi-Fi Outdoor Camera	Camera name You can change the name of the camera in the advanced settings.
Live	Display of the connection strength between camera and router

5.6.4. Stream indicators

Full HD, Direct, Good, 171.0 KB/s	
CIF VGA HD Full HD	Display the resolution of the current stream
Directly Relay server	Display of the current connection status Directly: The Peer2Peer server was able to establish a direct connection between your end device and the camera. Relay server*: The Peer2Peer server could not establish a direct connection. The video data is stored on the relay server for a short time so that your end device can obtain the data from the server. This causes a delay in the stream.
Low Normal Good	Display of the current assessment of the connection This represents the connection between the base station and the router.
xxx KB/s	Display of the currently consumed kilobits per second

	<p>*Note</p> <p>If the connection to your camera is always made via the relay server, please check the following settings:</p> <ul style="list-style-type: none"> • Check whether UPnP is activated in your router • Check whether a hardware firewall or a software firewall denies a direct connection • Check whether several "hops" (routers) are installed between the terminal and the Internet.
---	--

5.7. App2Cam Plus: Event list / playback

5.7.1. Event list

In the event list you can set a start and end time. For this filter, the app shows you all recorded events in this time.

The timeline above shows the frequency of triggers for different time periods.

Recordings with object recognition are displayed with icons for the recognition.

Click on the preview image to view it, here the triggering object is shown.

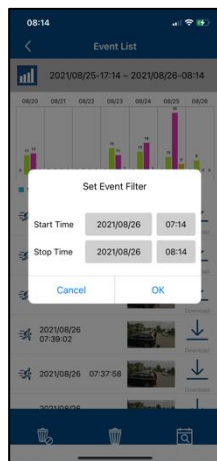

5.7.1

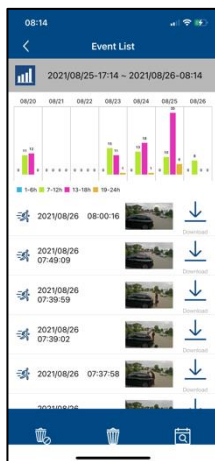

5.7.2

5.7.2. Event list functions

	<p>Delete all events This selection deletes all events in the list.</p>
	<p>Delete individual events Delete individual events from the list</p>
	<p>Set event filter again To filter events better, you can set the period again here.</p>
	<p>*Note Recordings cannot be accessed during a recording.</p>

5.8. Playback



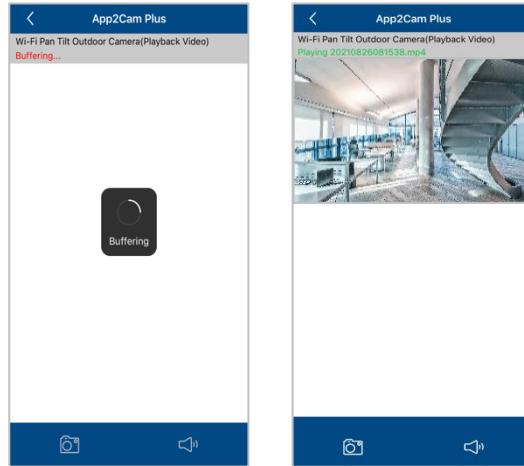

In the playback of the events, different functions are available depending on the camera model. In Landscape mode (= landscape format), a full view without functions is shown.

The events usually need a short buffer time until the event can be played.



	<p>Note When playing back events, the event is automatically downloaded to your mobile device. We therefore recommend that you mainly operate the playback via WI-FI in order to keep the consumption of the data volume low.</p>
--	--

5.8.1. Playback functions

 	
	<p>Create snapshot You have the option to take a screenshot of your playback. The picture is then saved in your photo gallery on your mobile device. The saved images are time-stamped and stored in the photo gallery.</p>
 	<p>Enable/disable audio Here you have the option to activate or deactivate audio for playback.</p>

5.8.2. Download & Forwarding

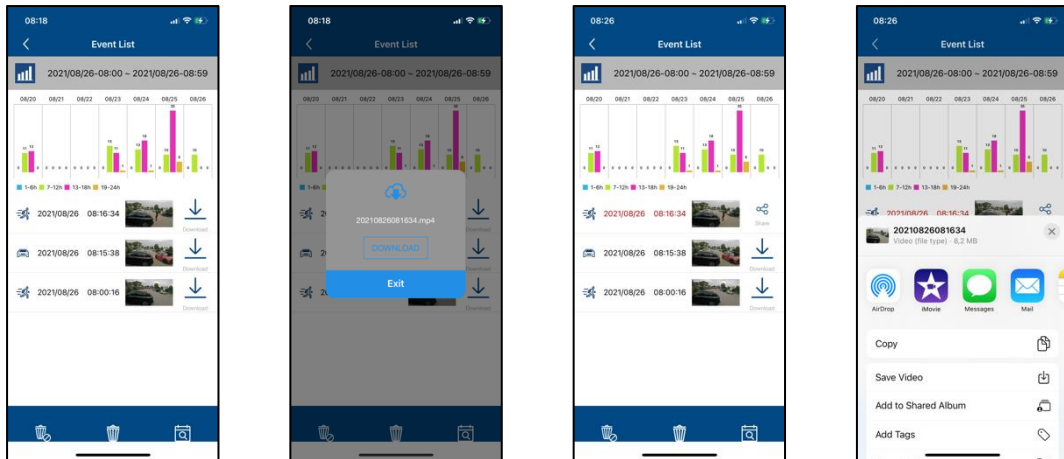

To download a file to your smartphone, click on the download icon to the right of the event. The file is now downloaded and is then displayed in red in the event list. Now you have the possibility to share the file by clicking on Share.



Note

The downloaded data is stored differently on the iOS and Android operating systems.

iOS: The events are stored on the device and can only be played back with iTunes.

Android: The saved data can be found in the device manager under "*internal memory/record/camera DID*".

5.9. Advanced settings

5.9.1. Open advanced settings

To open the advanced settings, click on the 1) settings icon at the bottom and then on the 2) settings icon in the camera image.

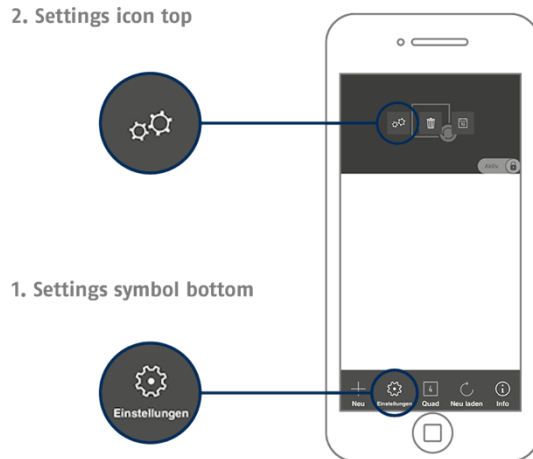

Use the admin password that you assigned during the initial installation.



Note

The admin password is a purpose password, not a security password, and is intended to help you allow others to view the live image and notifications, but to deny the advanced settings.

5.9.2. Login data

You can manually change the camera's login data in the settings:

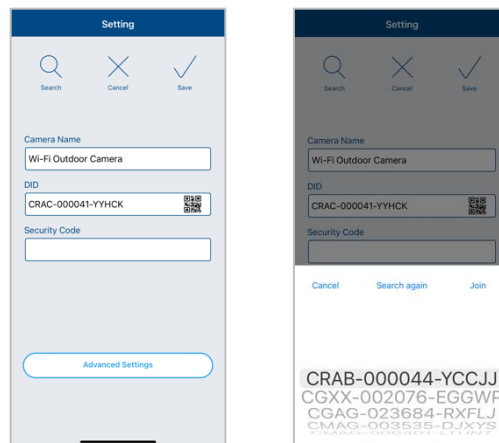

System Name:

Change the name of the camera.

DID:

Manually change the DID of the camera.

Security code:

Enter the security code of the camera.

By using the "Search" button, you can automatically replace the DID of the camera with another found camera.

Discard changes with the "Cancel" button or save them with the "Save" button.

5.9.3. Automatic login

When entering the admin password, you can use the "Auto login" button to save the admin password on your mobile device so that you do not have to enter it the next time you call up the advanced settings on your mobile device. This does not apply to access from other terminals.

5.9.4. Advanced settings

The individual menu items are grouped and can be opened and closed using the arrows.

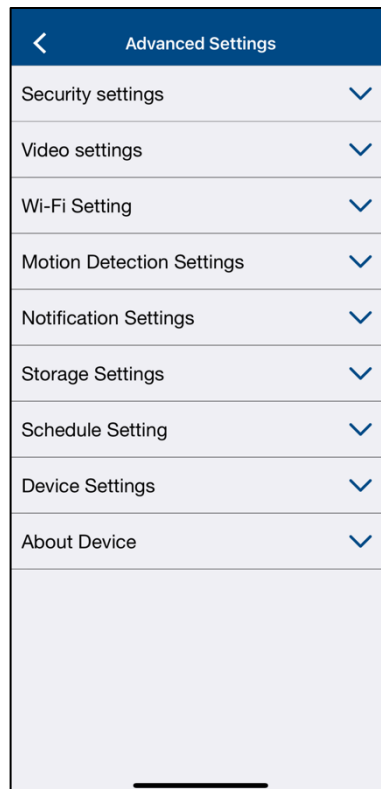

Note



The arrangement of the individual points differs from Android. Despite this, the functionalities are available and identical on both platforms.



Note

Please always make changes to the settings of the camera in the local network of the camera. We strongly advise you not to make changes to the settings in a public WI-FI, as it is always possible for other people to make recordings.

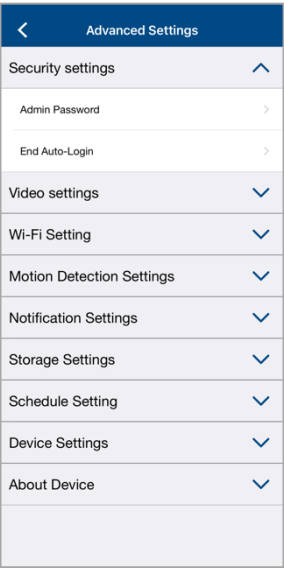

5.9.5. Security settings

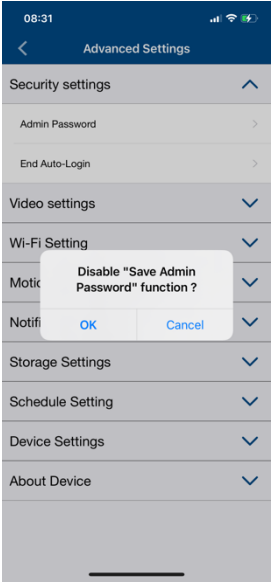
<p>Security settings</p>	 <p>The screenshot shows the 'Advanced Settings' menu. The 'Security settings' option is highlighted in blue and has an upward-pointing chevron. Other options include Admin Password, End Auto-Login, Video settings, Wi-Fi Setting, Motion Detection Settings, Notification Settings, Storage Settings, Schedule Setting, Device Settings, and About Device, each with a downward-pointing chevron.</p>	<p>Make the security settings for your camera here.</p> <p>The changes in the settings are only applied after exiting the menu.</p>
<p>Reset security code</p>		<p>The security code is used to set up the camera in the app.</p> <p>During installation, replace the default security code with one of your own choosing.</p> <p>If you have forgotten your security code, you can reset the camera by pressing the reset button for approx. 3 seconds and assign a new security code.</p> <p>After resetting, remove the camera from App2Cam Plus and start setting it up using the setup wizard.</p> <p>The default security code is "123456".</p> <p>Attention:</p> <p>All settings including the network connection are lost.</p>
<p>Change admin password</p>	 <p>The screenshot shows the 'Admin Password' dialog box. It has a title bar with 'Cancel', 'Admin Password', and 'OK' buttons. Below the title bar are three input fields: 'Old password:', 'New password:', and 'Confirm password:'.</p>	<p>The admin password grants access to the advanced settings and enables / disables the camera recordings.</p> <p>During installation, you assign your own admin password.</p> <p>If you have forgotten your admin password, you can reset the camera by pressing the reset button for approx. 3 seconds.</p> <p>The default admin password is "123456".</p> <p>Attention:</p> <p>All settings including the network connection are lost.</p>

<p>End auto login</p>		<p>If you have already activated Auto Login, you can deactivate the function here. This menu item is only displayed if the function has already been activated.</p>
------------------------------	---	---

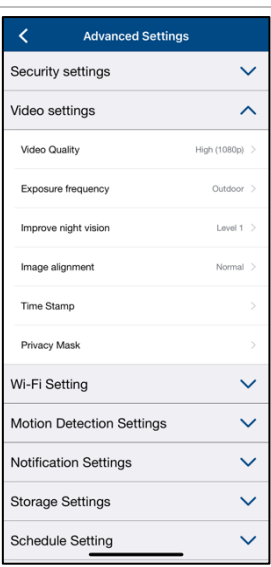
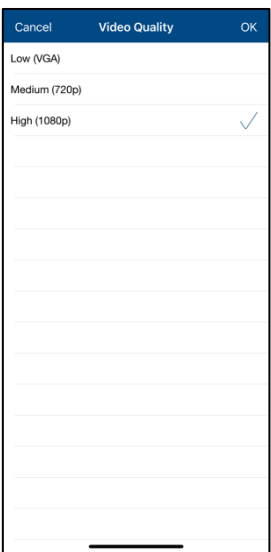
5.9.6. Video settings

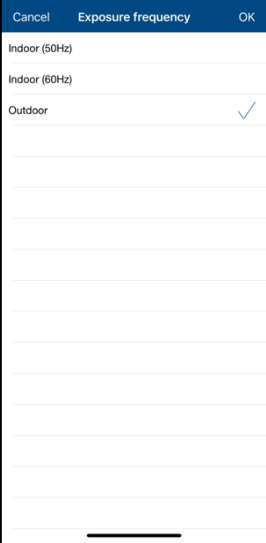
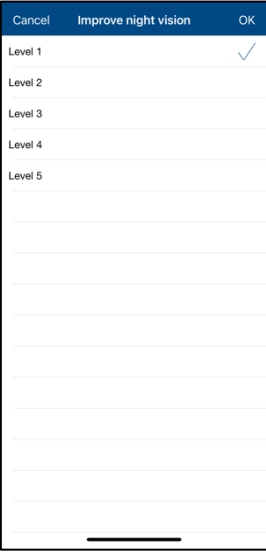
<p>Video settings</p>		<p>Make the video settings for your camera here. The changes in the settings are only applied after exiting the menu.</p>
<p>Video quality</p>		<p>Here you have the option to change the resolution for the live view. With a lower resolution, you can get a smoother picture when accessing externally, but less picture detail is available.</p> <p>The value set here has no effect on the recording, which is always saved in Full HD (1080p).</p>

<p>Exposure frequency</p>		<p>Here you have the option of selecting the mains frequency for your camera.</p> <p>The following selections are available: Indoor (50Hz), Indoor (60Hz) and Outdoor.</p> <p>Standard value Europe: 50 Hz</p>
<p>Improve night vision</p>		<p>Here you can adjust the brightness of the night image.</p> <p>A higher level brightens the picture more, a lower level less.</p> <p>As soon as there are objects in the near surrounding of the camera, it is advisable to set the intensity to low to avoid reflections in the image, but this will reduce the range of the LEDs.</p>
<p>Timestamp</p>		<p>Change the position of the timestamp by briefly holding and sliding the timestamp to the desired corner.</p> <p>Change the color of the timestamp by clicking on the desired color.</p> <p>Remove the time stamp by clicking once on the image.</p> <p>Changes are only adopted when saved. The "Reload" button refreshes the preview image.</p>

Privacy Zone Masking

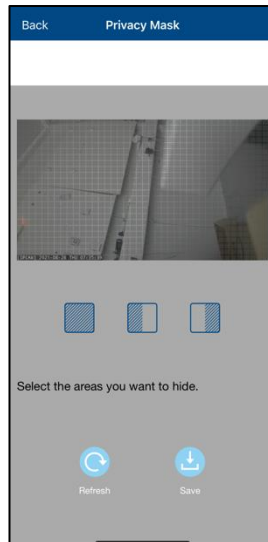

A preview of the live image and the privacy zone set up is displayed here. Drawing privacy zones is done directly in the preview area.

Select the desired privacy zone area by tapping the squares.

The drawn area is made unrecognizable in black and is therefore not visible in the live image or in the recording.

Click on Save to apply the selection.



Delete the selection



Preset selection ranges

5.9.7. Sound settings

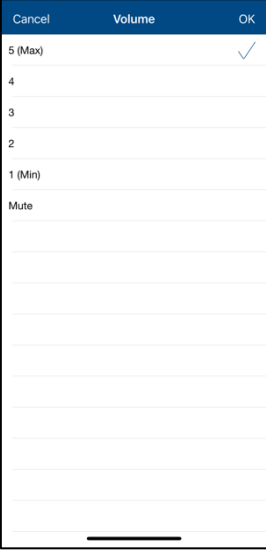
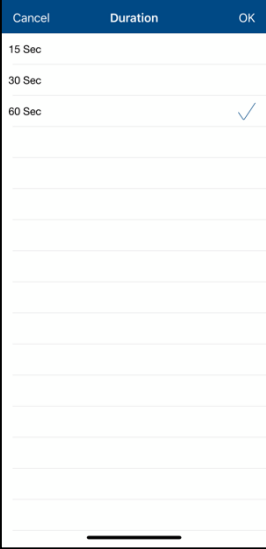
<p>Siren settings (PPIC42520 / PPIC42520B only)</p>	 <p>The screenshot shows the 'Advanced Settings' menu. The 'Sound Setting' option is highlighted with a blue bar and an upward-pointing arrow. Other options include Security settings, Video settings, Wi-Fi Setting, Motion Detection Settings, Notification Settings, Storage Settings, Schedule Setting, Device Settings, and About Device.</p>	<p>Make the siren settings here. The changes in the settings are only applied after exiting the menu.</p>
<p>Volume (PPIC42520 / PPIC42520B only)</p>	 <p>The screenshot shows a dialog box titled 'Volume' with 'Cancel' and 'OK' buttons. The list includes '5 (Max)' (checked), 4, 3, 2, 1 (Min), and Mute.</p>	<p>Change the volume of the integrated siren here.</p>
<p>Duration (PPIC42520 / PPIC42520B only)</p>	 <p>The screenshot shows a dialog box titled 'Duration' with 'Cancel' and 'OK' buttons. The list includes 15 Sec, 30 Sec, and 60 Sec (checked).</p>	<p>Change the duration of the integrated siren.</p>

5.9.8. WI-FI settings

WI-FI settings

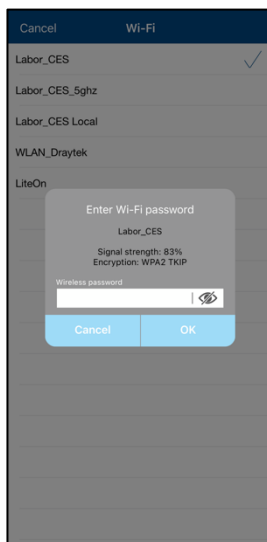
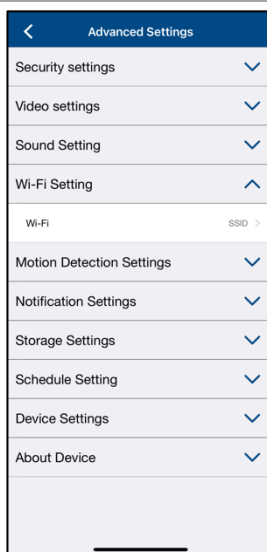

In WI-FI settings, you can select the desired network to which the camera is to be connected.

When you select the menu item, all networks in the surrounding are displayed. Select your network and enter your WI-FI password.

The window for entering the password also shows you the signal strength to the network; make sure that the signal strength is sufficient to avoid transmission problems.

Enter the password and confirm with OK.



To prevent access by strangers, protect your network by encrypting it with WPA/ WPA2/ WPA2-PSK.



The settings are only applied after leaving the menu.



If the connection was unsuccessful or the wrong Wi-Fi information was entered, press the reset button for 3 seconds to reset the camera to factory settings.

5.9.9. Motion detection settings

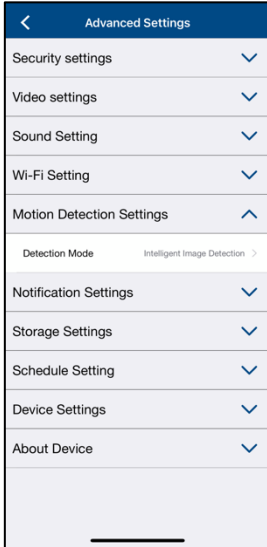
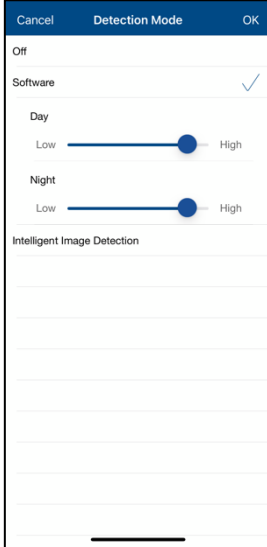
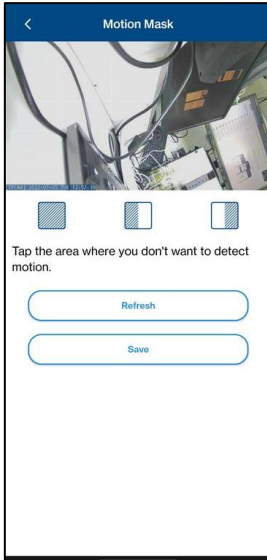
<p>Motion detection settings</p>		<p>Make settings for motion detection here. Click on Detection Mode for further settings. If "Off" is selected, there is no motion detection.</p> <p>The changes in the settings are only applied after exiting the menu.</p>
<p>Software</p>		<p>Make the settings for motion detection here.</p> <p>There is no differentiation between objects, every moving object triggers a recording.</p> <p>With the sliders you can change the sensitivity of the motion detection for day and night.</p> <p>Click OK to apply the settings.</p>
<p>Motion Mask</p>		<p>A preview of the live image and the motion mask set up is displayed here. The selection of hidden areas takes place directly in the preview area.</p> <p>If a field has been selected in the grid, motion detection no longer takes place in this area.</p> <div style="display: flex; align-items: center; margin-top: 10px;"> <div style="width: 20px; height: 20px; background-color: #ccc; border: 1px solid #000; margin-right: 5px;"></div> Delete selection </div> <div style="display: flex; align-items: center; margin-top: 10px;"> <div style="width: 20px; height: 20px; background-color: #ccc; border: 1px solid #000; margin-right: 5px;"></div> <div style="width: 20px; height: 20px; background-color: #ccc; border: 1px solid #000; margin-right: 5px;"></div> Default selected areas </div>

Motion tracking (PPIC42520/ PPIC42520B only)

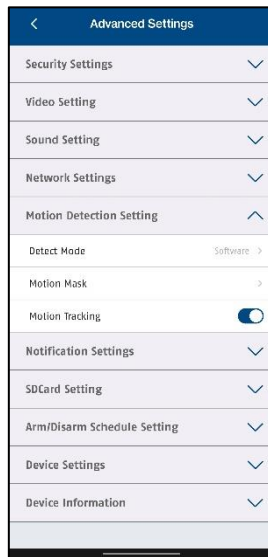

When motion tracking is activated, objects in the image are tracked as they move.
The tracked object is marked with a green frame.



The reliability of object tracking depends on local factors. In various situations, false alarms can still occur.

Environmental influences such as rain, snow, insects or dirt can have a negative effect on the results.

As soon as a second object is detected in the image section, this causes the new object to be tracked.

Intelligent image detection

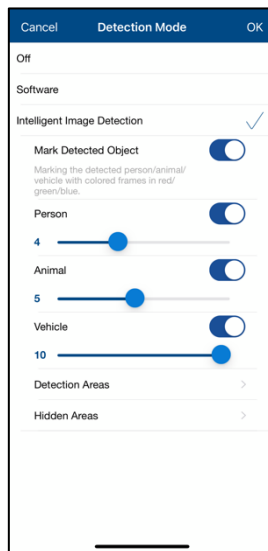

With the Intelligent Image Detection, you can access the Intelligent Detectors which analyses the current video image.

Multiple selection is possible.

Mark detected object

When activated, detected objects are marked with colored frames.

Intelligent object recognition

Thanks to a built-in AI chip, the camera can distinguish between individual objects to achieve a lower false alarm tolerance.

The camera distinguishes between the following objects:

- People
- Animals
- Vehicles

You can fine-tune the sensitivity of the detectors using the sliders, with the value 1 representing the lowest sensitivity and the value 10 the highest sensitivity of detection.

Please observe the notes under point "4. object recognition".

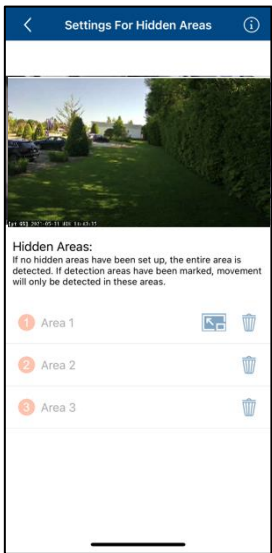

The reliability of object detection depends on local factors. Nevertheless, false alarms may occur in various situations. Environmental influences such as rain, snow, insects, or dirt can have a negative effect on the results.

<p>Detection areas (region of interest)</p>		<p>The detection areas, also called Region of Interest, describe the areas in which Intelligent Object Recognition searches for people, vehicles, or animals.</p> <p>You can activate up to 3 regions and place and adjust them individually by drag and drop.</p> <p>By default, the entire image area is marked.</p> <p>Please observe the notes under point "4. object recognition".</p>
<p>Hidden areas (Region of Non-Interest)</p>		<p>The hidden areas, also called region of non-interest, describe the areas that can be hidden for intelligent object recognition.</p> <p>No persons, vehicles or animals are detected within this area.</p> <p>You can activate up to 3 regions and place and adjust them individually by drag and drop.</p> <p>Please observe the notes under point "4. object recognition".</p>

5.9.10. Notification Settings

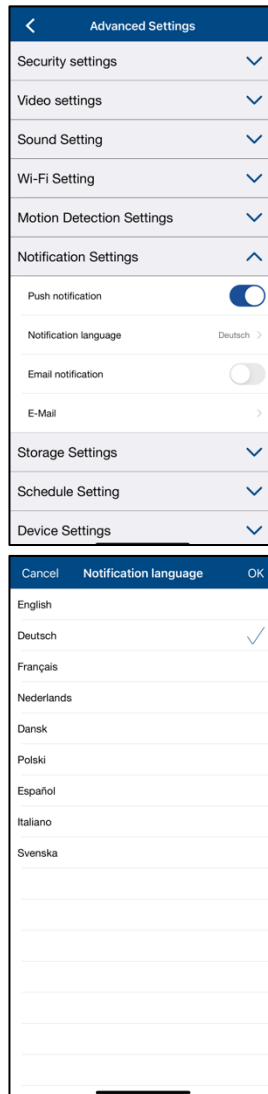
Activate PUSH notification / Notification language

Activate notifications to receive PUSH messages on your smartphone when motion is detected.

You have the option to change the language of the notification under Notification Language.

Please note that only the language of the PUSH notifications will be changed.

The language setting for the app remains and must be changed in the smartphone.

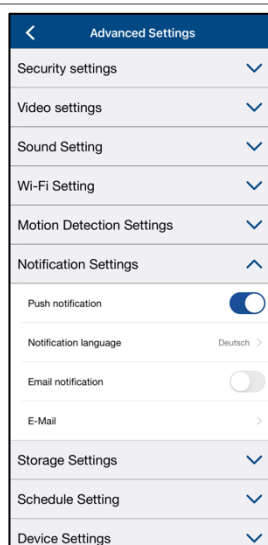
E-mail notification / e-mail**E-mail settings**

The e-mail settings are required for sending a notification.

Use SSL/TLS:

Activate the checkbox to transmit the e-mail in encrypted form. You can obtain the necessary settings from your e-mail provider.

SMTP Server:

Enter the SMTP server address here. e.g. smtp.test.com

SMTP Port:

Enter the SMTP port here. e.g. 465

Username:

Enter the sender's e-mail address here. e.g. xxx@test.com

Password:

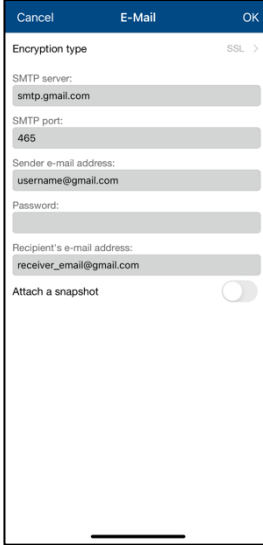

Enter the password of the sender e-mail here.

Recipient:

Enter the recipient's e-mail address here.
e.g. xxxx123@test.com

Save the settings with OK. When exiting the advanced settings, press "Confirm". Only then will the e-mail settings be applied.





We recommend using "googlemail" to send e-mails.

Activate the e-mail notification afterwards.

Please check with your email provider whether certain permissions may need to be activated.

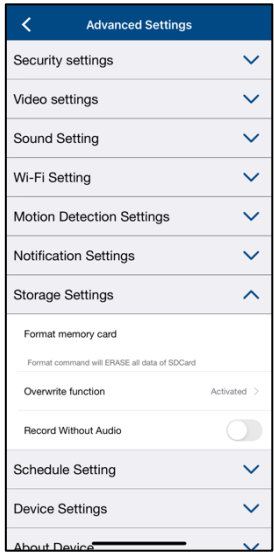
5.9.11. Memory settings

<p>Storage settings</p>		<p>Make settings for storage here.</p> <p>The changes in the settings are only applied after exiting the menu.</p>
<p>Format memory card</p>		<p>Format the SD card. For permanent use of an SD card, please use an SD card of class 10 or U1.</p> <p></p> <p>Formatting the SD card will delete all data. Please back up the data before formatting.</p>

Overwrite function



There are several ways to overwrite the events on the SD card.

OFF As soon as the SD card is full, no more recordings are saved.

Activates If this function is activated, the oldest recordings are overwritten with newer ones as soon as the SD card is full.

3 / 7 / 30 cycle The data on the SD card is deleted or overwritten after the selected number of days.

Recording without audio

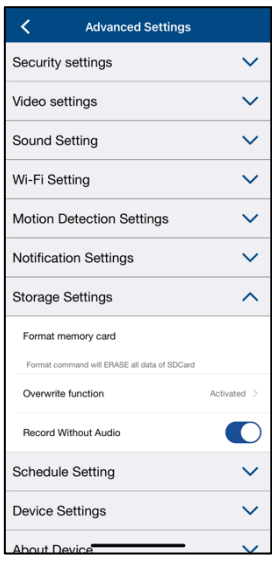

Activate the function to save the recordings without audio.

It is possible to activate audio during the live view.

5.9.12. Schedule settings

Activation / deactivation schedule

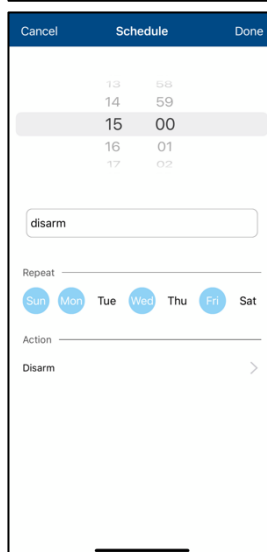
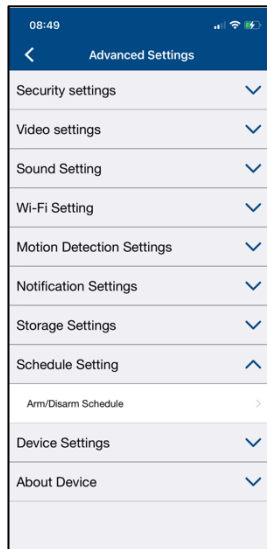

Schedule settings

Press the plus symbol **+** add a schedule. Separate activations are created for the start time and the end time.

Select the start time and assign a schedule name for it.

Select the days for the repeat and the action (enable / disable) for the start time.

Save by clicking on "Done".

For the end time, press the plus symbol **+** again.

Now enter the end time, the schedule name, and the repetition. Please select the contrast to the previous action and save it by clicking on "Done".

e.g.

Start time 21.00 hrs. from Mon-Fri, Action Activation

End time 06:00 from Mon-Fri, action deactivation

The camera only records during the period between 9pm - 6am when there is movement.

5.9.13. Device settings

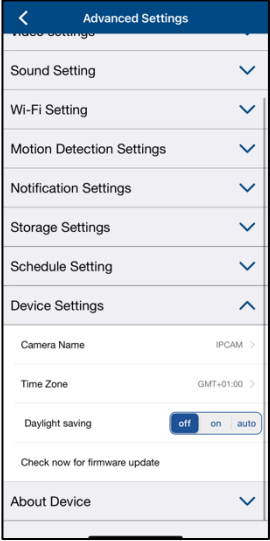
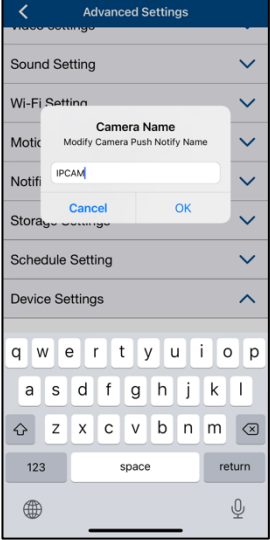
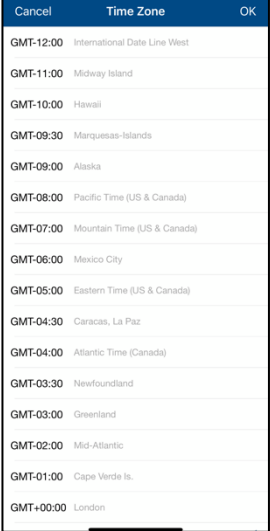
<p>Device settings</p>	 <p>The screenshot shows the 'Advanced Settings' menu with 'Device Settings' expanded. The expanded menu includes: Camera Name (IPCAM), Time Zone (GMT-01:00), Daylight saving (off), Check now for firmware update, and About Device.</p>	<p>Make the device settings for your camera here.</p> <p>The changes in the settings are only applied after exiting the menu.</p>
<p>Camera name</p>	 <p>The screenshot shows the 'Camera Name' dialog box with the text 'IPCAM' in the input field. A keyboard is visible below the dialog box.</p>	<p>Change the camera name here.</p> <p>The name is displayed in the live view as well as in the push notifications.</p>
<p>Time Zone / Daylight Saving Time</p>	 <p>The screenshot shows a list of world time zones from GMT-12:00 to GMT+00:00. The list includes: International Date Line West, Midway Island, Hawaii, Marquesas-Islands, Alaska, Pacific Time (US & Canada), Mountain Time (US & Canada), Mexico City, Eastern Time (US & Canada), Caracas, La Paz, Atlantic Time (Canada), Newfoundland, Greenland, Mid-Atlantic, Cape Verde Is., and London.</p>	<p>The world time zones are listed in the selection list. Select the time zone in which the camera will be installed.</p> <p>If the world time zone uses the changeover to daylight saving time, activate daylight saving time.</p>

Check for firmware update now

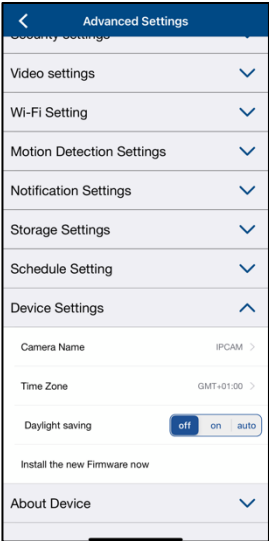

By selecting the menu item "Check for firmware updates now" you can search for current firmware updates.

Please note that an SD card is required for this!

The firmware update is downloaded in the background and saved on the microSD card. To do this, exit the settings of the camera.

After about 5 minutes, you will receive a PUSH notification or, after re-entering the Advanced Settings, a notice that a new update has been successfully downloaded.

Now click on "Install Firmware Update Now" to start the installation process. This may take a few minutes.

5.9.14. Device information

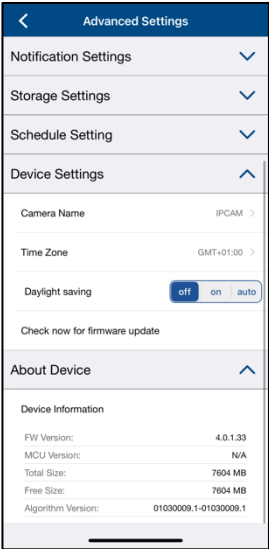

About Device



The device information gives you information about the current firmware version of the camera, the total available memory and the free memory on the SD card.

6. Update firmware

You can update the firmware of your camera in two different ways. Please note that with both methods, the camera's settings are still retained, so you do not need to set them again.

	<p>Please note that a microSD card is required for both variants.</p>
	<p>Updating the camera takes approx. 3-5 minutes. Do not disconnect the camera from the power supply during this time!</p>

6.1. Updating via server

Option 1:

The camera checks at 6-hour intervals whether new firmware is available on the firmware server for the camera. Insert a microSD card into your camera so that it can download the firmware automatically. After the camera has downloaded the firmware, the next time you enter the advanced settings, a notice will appear, or you will receive a PUSH message so that you can start the update. Click on the menu item "Check for firmware update now". A message appears that the camera is ready for the update.

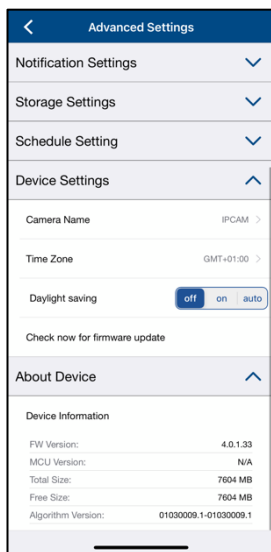

1

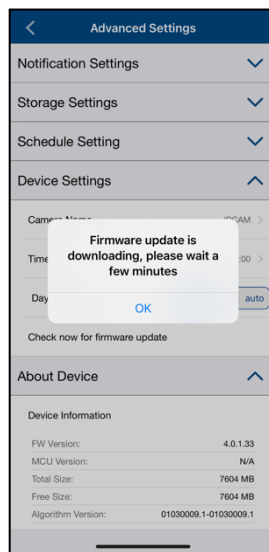

2

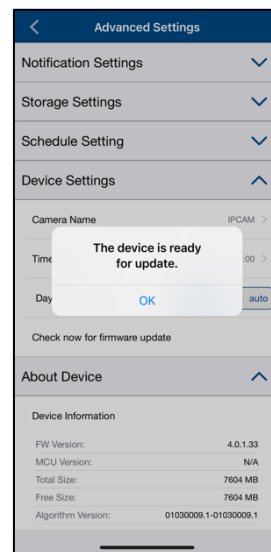

3

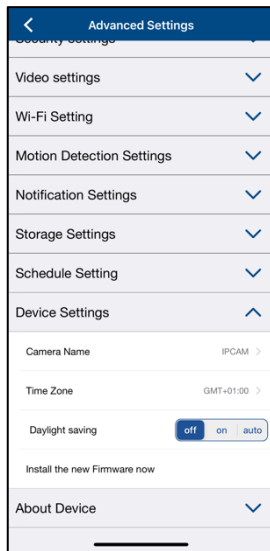

4

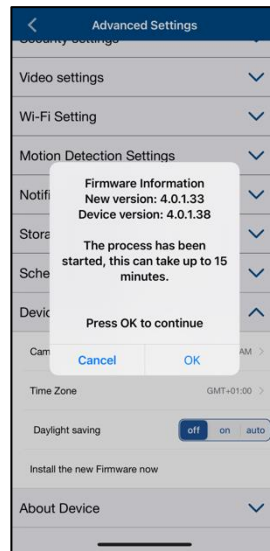

5

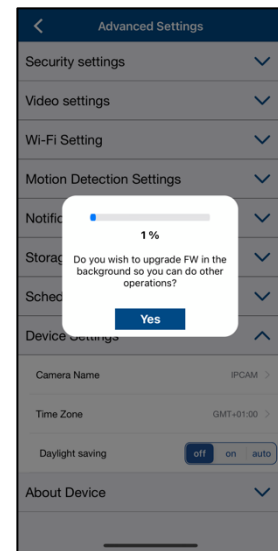

6

Option 2:

If you do not want to wait for the 6-hour interval, you can also have the camera actively search for a newer firmware. To do this, press the menu item "Check for firmware updates now" in the advanced settings, if a firmware has not already been downloaded, the camera will now actively search for a newer version and then save it to the SD card, this can take up to 5 minutes, to do this, exit the camera settings.

After the camera has downloaded the firmware, the next time you enter the advanced settings, a notice will appear, or you will receive a PUSH message so that you can confirm the installation of the firmware. To do this, click on the menu item "Install firmware update now",

6.2. Current firmware version

For the cameras, some functions are only available with the latest firmware version. Therefore, make sure that your devices are always up to date.

The current firmware versions can be found on the respective product page.

7. Troubleshooting tips

Camera image is not displayed

Check the signal strength in the live view

Is the camera connected?

Is there an internet connection?

Push messages are not received

Is the camera deactivated? Also check the schedules.

Are the push messages deactivated?

Is there an internet connection?

How can I set my camera to factory settings?

Unscrew the cover and press the reset button for at least 3 seconds with the enclosed reset tool or e.g. a paper clip. The LED starts to flash red. As soon as the factory settings are loaded, the LED flashes permanently.

Your Wi-Fi is not displayed in the selection list in the camera app.

If your personal Wi-Fi network does not appear in the selection list, please check the following:

1. Make sure that the SSID of your router is visible.
2. Change the encryption type of your router to WPA / WPA2 / WPA2-PSK.

Low network signal or poor picture quality

Possible causes could be:

1. Wi-Fi network devices can interfere with signal transmission, ensure sufficient distance between the camera and other Wi-Fi devices.
Possible interfering factors can be thick brick walls, exterior walls, glass, water pipes and metal.
2. Remove dirt from the camera. This can have a negative influence on the image quality.

What could be the causes for the unit not recording when there is movement?

Possible causes could be:

1. Is the SD card inserted correctly?
2. Is the camera activated?
3. Are the schedules set correctly?
4. Make sure you use a class 10 SD card.

The camera image is superimposed (white areas in the image).

The camera has IR LEDs for night operation. The light is reflected on reflective surfaces such as glass or white surfaces. Do not place the camera in front of glass surfaces and make sure to install it in protected outdoor areas.

What could be the causes of an SD card error?

Please check the following:

1. Make sure that the SD card has been inserted and formatted correctly. Please save important data before formatting, they will no longer be available afterwards.
2. Make sure to use only a class 10 or higher SD card.

The time and date display are not correct.

Possible causes could be:

1. Are the date and time settings of your mobile device set correctly? The system takes the time from your mobile device.
2. Is the correct time zone selected? Is the switch to daylight saving time deactivated?
3. Restart the camera by unplugging it and plugging it back in after about 5 seconds.

8. Open Source License Notes

The product contains software components that are licensed by the rights holders as free software or open source software (hereinafter referred to as "OSS"). The corresponding licenses are enclosed with the product in printed form and/or can be accessed via a graphical user interface. You can acquire rights of use to the extent regulated therein directly from the rights holders.

The Open Source Licenses take precedence over all other license terms and contractual agreements with ABUS in respect of the relevant OSS software components contained in the Product.

In general, license information for ABUS products can be found at www.abus.com in the download area of the product description.