



# PSW-Series

## Multi-Range D.C. Power Supply

### FEATURES

- Voltage Rating : 30V/40V/80V/160V/250V/800V,  
Output Power Rating : 360W~1080W
- Multi-range Voltage & Current Combinations in One Power Supply
- C.V/C.C Priority ; Particularly Suitable for the Battery and LED Industry
- Adjustable Slew Rate
- Series Operation (2 units in Series) for (30V/40V/80V/160V), Parallel  
Operation (3 units in Parallel) for (30V/40V/80V/160V/250V/800V)
- High Efficiency and High Power Density
- 1/2, 1/3, 1/6 Rack Mount Size Design (EIA/JIS Standard) for  
360W, 720W, 1080W
- Standard Interface : LAN, USB, Analog Control Interface
- Optional Interface : GPIB-USB Adaptor, RS232-USB Cable
- LabVIEW Driver

**GWINSTEK**  
Simply Reliable

# Powerful Stretch with Multi-range Technology

The PSW-Series is a single-output multi-range programmable switching DC Power Supply covering a power range up to 1080W. This series of products include fifteen models with the combination of 30V, 40V, 80V, 160V, 250V and 800V rated voltages and 360W, 720W and 1080W maximum output powers. The multi-range feature allows the flexible and efficient configuration of voltage and current within the rated power range. As the PSW-Series can be connected in series for maximum 2 units or in parallel for maximum 3 units, the capability of connecting multiple PSW-Series units for higher voltage or higher current output provides a broad coverage of applications. With the flexibility of multi-range power utilization and series/parallel connection, the PSW-Series significantly reduces the users' cost for various power supply products to accommodate the projects with different power requirements.

The C.V/C.C priority selection of the PSW-Series is a very useful feature for DUT protection. The conventional power supply normally operates under C.V mode when the power output is turned on. This could bring a high inrush current to the capacitive load or current-intensive load at the power output-on stage. Taking the I-V curve verification of LED as an example, it becomes a very challenging task to perform this measurement using a conventional power supply. With LED connected to a power supply under C.V mode as the initial setting, when the power output is turned on and the voltage rises to the LED forward voltage, the current will suddenly peak up and exceed the preset value of current limit. Upon detecting this high current, the power supply starts the transition from C.V mode to C.C mode. Though the current becomes stable after the C.C mode being activated, the current spike occurred at the C.V and C.C crossover point may possibly damage the DUT. At the power output-on stage, the PSW-Series is able to operate under C.C priority to limit the current spike occurred at the threshold voltage and therefore protects DUT from the inrush current damage.

The adjustable slew rate of the PSW-Series allows users to set for either output voltage or output current, a specific rise time from low to high level transition, and a specific fall time from high to low level transition. This facilitates the characteristic verification of a DUT during voltage or current level changes with controllable slew rates. Most manufacturing tests of lighting device or large capacitor during power output-on are associated with the occurrence of high surge current, which can greatly reduce the life time of the DUT. To prevent inrush current from damaging current-intensive devices, a smooth and slow voltage transition during power On-Off can significantly reduce the spike current and protect the device from high current damage.

The OVP and OCP are provided with the PSW-Series. Both OVP and OCP levels can be selected, with default level set at 110%, of the rated voltage/current of the power supply. When any of the protection levels is tripped, the power output will be switched off to protect the DUT. The PSW-Series provides USB Host/Device and LAN interfaces as standard, GPIB-USB adapter and RS232-USB cable as optional. The LabView driver and the Data Logging PC software are supported on all the available interfaces. An analog control/monitoring connector is also available on the rear panel for external control of power On/Off and external monitoring of power output Voltage and Current.

# PANEL INTRODUCTION



1. Voltage Knob
2. Current Knob
3. Output Key
4. Function Keys
5. USB A Port
6. Display
7. Cover Panel
8. Power Switch
9. Analog Control Connector
10. USB B Port
11. Output Terminal (+)
12. Sense Terminal(+/-)
13. Output Terminal (-)
14. Fan
15. AC Input
16. LAN Port

PSW-Series (HV) Rear Panel



PSW-Series (LV) Rear Panel



PSW 80-40.5 (0-80V, 0-40.5A, 1080W)

## PARALLEL OPERATION ( 3 UNITS )

MODEL	SINGLE UNIT	2 UNITS	3 UNITS
PSW 30-36	30V/36A	30V/72A	30V/108A
PSW 30-72	30V/72A	30V/144A	30V/216A
PSW 30-108	30V/108A	30V/216A	30V/324A
PSW 40-27	40V/27A	40V/54A	40V/81A
PSW 40-54	40V/54A	40V/108A	40V/162A
PSW 40-81	40V/81A	40V/162A	40V/243A
PSW 80-13.5	80V/13.5A	80V/27A	80V/40.5A
PSW 80-27	80V/27A	80V/54A	80V/81A
PSW 80-40.5	80V/40.5A	80V/81A	80V/121.5A
PSW 160-7.2	160V/7.2A	160V/14.4A	160V/21.6A
PSW 160-14.4	160V/14.4A	160V/28.8A	160V/43.2A
PSW 160-21.6	160V/21.6A	160V/43.2A	160V/64.8A
PSW 250-4.5	250V/4.5A	250V/9A	250V/13.5A
PSW 250-9	250V/9A	250V/18A	250V/27A
PSW 250-13.5	250V/13.5A	250V/27A	250V/40.5A
PSW 800-1.44	800V/1.44A	800V/2.88A	800V/4.32A
PSW 800-2.88	800V/2.88A	800V/5.76A	800V/8.64A
PSW 800-4.32	800V/4.32A	800V/8.64A	800V/12.96A

## SERIES OPERATION ( 2 UNITS )

MODEL	SINGLE UNIT	2 UNITS
PSW 30-36	30V/36A	60V/36A
PSW 30-72	30V/72A	60V/72A
PSW 30-108	30V/108A	60V/108A
PSW 40-27	40V/27A	80V/27A
PSW 40-54	40V/54A	80V/54A
PSW 40-81	40V/81A	80V/81A
PSW 80-13.5	80V/13.5A	160V/13.5A
PSW 80-27	80V/27A	160V/27A
PSW 80-40.5	80V/40.5A	160V/40.5A
PSW 160-7.2	160V/7.2A	320V/7.2A
PSW 160-14.4	160V/14.4A	320V/14.4A
PSW 160-21.6	160V/21.6A	320V/21.6A
PSW 250-4.5	N/A	N/A
PSW 250-9	N/A	N/A
PSW 250-13.5	N/A	N/A
PSW 800-1.44	N/A	N/A
PSW 800-2.88	N/A	N/A
PSW 800-4.32	N/A	N/A



PSW 80-27 (0-80V, 0-27A, 720W)



PSW 80-13.5 (0-80V, 0-13.5A, 360W)

## A. MULTI-RANGE OPERATION

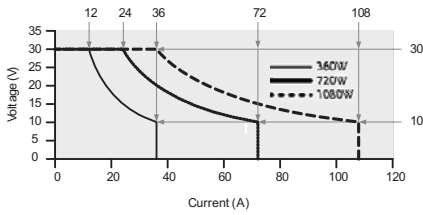

PSW 30V Series Operating Area

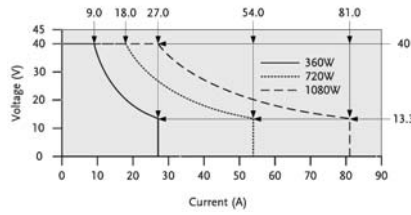

PSW 40V Series Operating Area

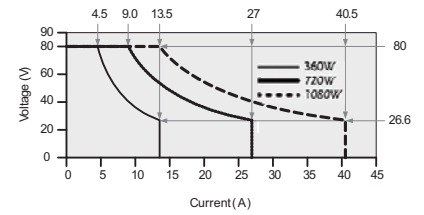

PSW 80V Series Operating Area

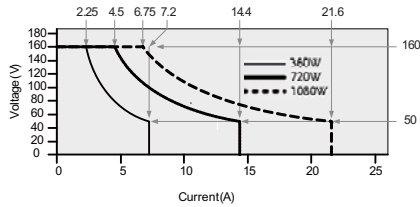

PSW 160V Series Operating Area

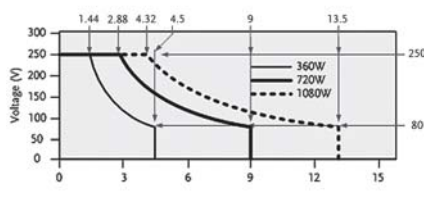

PSW 250V Series Operating Area

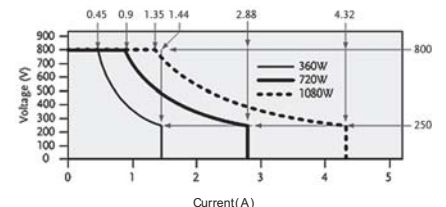

PSW 800V Series Operating Area

When the power supply is configured that the total output (Current x Voltage output) is less than the rated power output, it functions as a typical Constant Current (C.C) and Constant Voltage (C.V) power supply.

However, when the power supply is configured such that the total output power (Current x Voltage Output) exceeds the rated power output, the effective output is actually limited to the operation area of the unit.

## B. C.V / C.C PRIORITY SELECTION

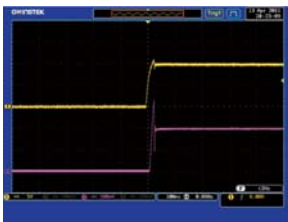

The Inrush Current and Surge Voltage occur at LED Forward Voltage ( $V_f$ ) Under C.V Priority



The CC Priority Feature Effectively Limits the Occurrence of Inrush Current and Surge Voltage when the Supplied Voltage Rises to the LED Forward Voltage

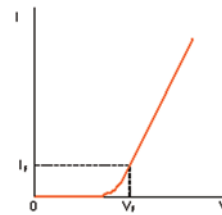

V-I Characteristic of Diode

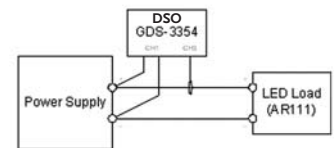

Operation Under C.V Priority and C.C Priority Respectively

The PSW-Series provides C.C Mode and C.V Mode to fit various applications in the general purpose market. To get into critical application niches, however, the power supply needs to provide

advanced features to meet the specific requirements. The C.C and C.V Priority Selection enable the power supply to run under C.C priority, rather than normal CV priority, at the output-on stage.

## C. ADJUSTABLE SLEW RATE

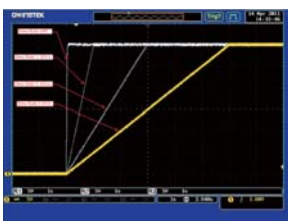

The Adjustable Rise Time of the PSW 30V



The Adjustable Rise Time of the PSW 800V

The PSW-Series has adjustable slew rates for the level transition of both Current and Voltage. This gives the PSW-Series power supply the ability to set specific rise time and fall time of the Voltage and Current drawn from the power supply to verify DUT performance during the Voltage / Current level transition. The feature also provides the benefit to slow down the voltage transition at the power output-on to protect DUT from inrush current damage. This is especially useful for the test of heavy-current-drawn devices like capacitors.

## D. BLEEDER CONTROL

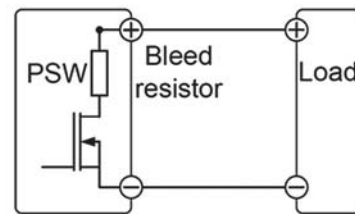

PSW-Series Built-in Bleed Resistor

The PSW-Series employs a bleed resistor in parallel with the output terminal. Bleed resistor is designed to dissipate the power from the power supply filter capacitors when power is turned off and the load is disconnected. Without a bleed resistor, power terminal may remain charged on the filter capacitors for some time and be potentially hazardous. In addition, bleed resistor also allows for smoother voltage regulation of the power supply as the bleed resistor acts as a minimum voltage load. The bleed resistance can be turned on or off using the configuration setting.

## E. SERIES AND PARALLEL CONNECTIONS

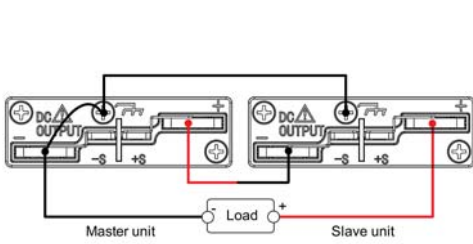

**Series Connection**

To increase power output capacity, the PSW-Series could be connected in Series mode to perform double voltage rating or in parallel mode to perform triple current rating for each model. With Multi-Range feature

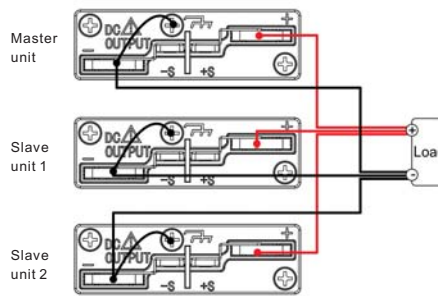

**Parallel Connection**

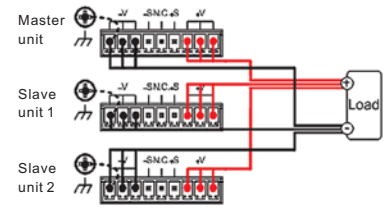

**Parallel Connection**

PSW 250V/800V only support parallel connections and maximum units in parallel is three.

and Series/Parallel connection capability, the PSW-Series is a high power density and cost-effective equipment for the tests of DC power modules, batteries and components in a broad power range.

## F. OUTPUT ON /OFF DELAY

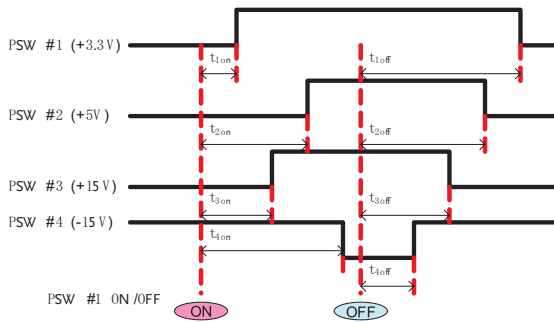

The Example of Output On/Off Delay Control Among Multiple Outputs of the PSW Units

The output On/Off delay feature enables the setting of a specific time delay for output on after the power supply output is turned on, and a specific time delay for output off after the power supply output is turned off. When multiple PSW units are used, the On/Off delay time of each unit can be set respectively referring to fix time points. This multiple-output control can be done through the Analog Control terminal at the rear panel or through the PC programming with standard commands.

## G. USING THE RACK MOUNT KIT



**Rack Mount Kit GRA-410-J (JIS)**



**Rack Mount Kit GRA-410-E (EIA)**

The Rack Mount Kit of the PSW-Series supports both EIA and JIS standards. A standard rack can accommodate 6 units of type I (360W Output Power) models, or 3 units of type II (720W Output Power) models, or 2 units of type III (1080W Output Power) models. The Rack Mount Kits for EIA standard (P/N: GRA-410-E) and for JIS standard (P/N: GRA-410-J) are provided as optional accessories for the PSW-Series.

## H. VARIOUS INTERFACES SUPPORT & EXTENDED TERMINAL BOX

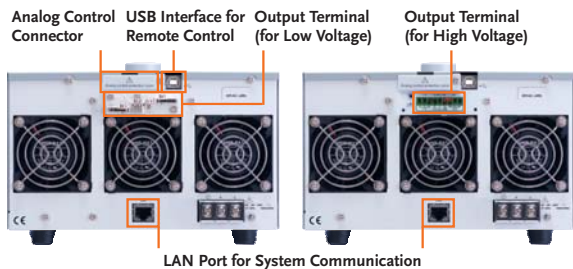

**Rear Panel for PSW-Series**

The PSW-Series provides USB Host port in the front panel for easy access of stored data, such as test script program. In the rear panel, a USB Device port is available for remote control or I & V data logging of power output through a PC controller. The LAN interface, which meets DHCP standard, is provided as a standard feature of the PSW-Series for system communications and ATE applications.



**GUG-001**  
GPIB to USB  
Adapter

**GET-001**  
Extended Terminal  
(for PSW 30V/40V/80V/160V)

**GET-002**  
Extended Terminal  
(for PSW 250V/800V)

**GET-005**  
Extended European Terminal  
(for PSW 30V/40V/80V/160V)

An Extender Terminal box (P/N: GET-001/GET-002/GET-005) is provided as optional accessory to extend the power output form the rear panel to the front side. This extender terminal gives R&D or QC engineers convenience to do the jobs without frequently reaching the output terminal at the rear side of the PSW-Series.

## I. EXTERNAL ANALOG REMOTE CONTROL

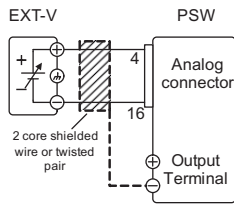

External Voltage Control of the Voltage Output

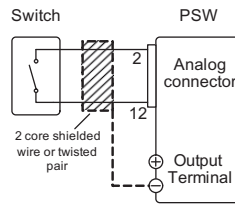

External Switch Control of the Main Power Shut-down

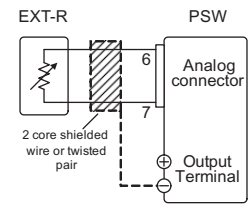

External Resistance control of the Voltage Output

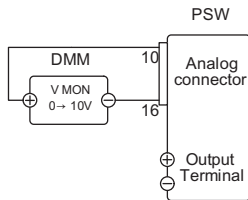

External DMM Monitoring of the Output Voltage

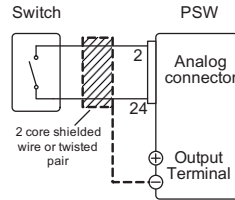

External Switch Control of the Output On/Off

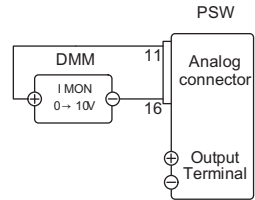

External DMM Monitoring of the Output Current

On the rear panel of the PSW-Series power supply, a 26-pin Analog Control connector is available to perform lots of remote control and monitoring functions. The output voltage and current can be set using external voltage or resistance.

The power supply output on/off and main power shut-down can also be controlled using external switches. This Analog Control Connector is complied with the Mil 26 pin connector (OMRON XG4 IDC plug) standard.

## OPTIONAL ASSESSORIES

PSW-001



PSW-002



PSW-003

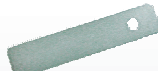

PSW-004



PSW-005



PSW-006



PSW-007



PSW-008

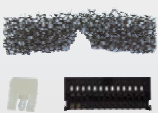

PSW-009



PSW-010



PSW-011



PSW-012

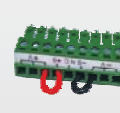

GTL-130



GUR-001A



GUG-001



GET-001



GET-002

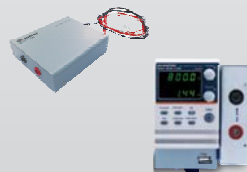

GET-005

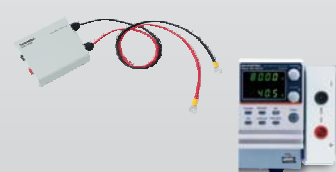

SPECIFICATIONS									
	PSW 30-36	PSW 30-72	PSW 30-108	PSW 40-27	PSW 40-54	PSW 40-81	PSW 80-13.5	PSW 80-27	PSW 80-40.5
<b>OUTPUT RATING</b>									
Voltage	0 ~ 30V	0 ~ 30V	0 ~ 30V	0 ~ 40V	0 ~ 40V	0 ~ 40V	0 ~ 80V	0 ~ 80V	0 ~ 80V
Current	0 ~ 36A	0 ~ 72A	0 ~ 108A	0 ~ 27A	0 ~ 54A	0 ~ 81A	0 ~ 13.5A	0 ~ 27A	0 ~ 40.5A
Power	360W	720W	1080W	360W	720W	1080W	360W	720W	1080W
<b>REGULATION(CV)</b>									
Load Line	20mV 18mV	20mV 18mV	20mV 18mV	25mV 23mV	25mV 23mV	25mV 23mV	45mV 43mV	45mV 43mV	45mV 43mV
<b>REGULATION(CC)</b>									
Load Line	41mA 41mA	77mA 77mA	113mA 113mA	32mA 32mA	59mA 59mA	86mA 86mA	18.5mA 18.5mA	32mA 32mA	45.5mA 45.5mA
<b>RIPPLE &amp; NOISE (Noise Bandwidth 20MHz; Ripple Bandwidth=1MHz)</b>									
CV p-p	60mV	80mV	100mV	60mV	80mV	100mV	60mV	80mV	100mV
CV rms	7mV	11mV	14mV	7mV	11mV	14mV	7mV	11mV	14mV
CC rms	72mA	144mA	216mA	54mA	108mA	162mA	27mA	54mA	81mA
<b>PROGRAMMING ACCURACY</b>									
Voltage	0.1% +10mV	0.1% +10mV	0.1% +10mV	0.1%+10mV	0.1%+10mV	0.1%+10mV	0.1% +10mV	0.1% +10mV	0.1% +10mV
Current	0.1% + 30mA	0.1% + 60mA	0.1% + 100mA	0.1%+20mA	0.1%+50mA	0.1%+80mA	0.1% + 10mA	0.1% + 30mA	0.1% + 40mA
<b>MEASUREMENT ACCURACY</b>									
Voltage	0.1% +10mV	0.1% +10mV	0.1% +10mV	0.1%+10mV	0.1%+10mV	0.1%+10mV	0.1% +10mV	0.1% +10mV	0.1% +10mV
Current	0.1% +30mA	0.1% +60mA	0.1% +100mA	0.1%+20mA	0.1%+50mA	0.1%+80mA	0.1% +10mA	0.1% +30mA	0.1% +40mA
<b>RESPONSE TIME</b>									
Raise Time	50ms	50ms	50ms	50ms	50ms	50ms	50ms	50ms	50ms
Fall Time(Full Load)	50ms	50ms	50ms	50ms	50ms	50ms	50ms	50ms	50ms
Fall Time(No Load)	500ms	500ms	500ms	500ms	500ms	500ms	500ms	500ms	500ms
Load Transient Recover Time (Load change from 50~100%)	1ms	1ms	1ms	1ms	1ms	1ms	1ms	1ms	1ms
<b>PROGRAMMING RESOLUTION (By PC Remote Control Mode)</b>									
Voltage	1mV	1mV	1mV	1mV	1mV	1mV	2mV	2mV	2mV
Current	1mA	2mA	3mA	1mA	2mA	3mA	1mA	2mA	3mA
<b>MEASUREMENT RESOLUTION (By PC Remote Control Mode)</b>									
Voltage	1mV	1mV	1mV	1mV	1mV	1mV	2mV	2mV	2mV
Current	1mA	2mA	3mA	1mA	2mA	3mA	1mA	2mA	3mA
<b>SERIES AND PARALLEL CAPABILITY</b>									
Parallel Operation	Up to 3 units including the master unit								
Series Operation	Up to 2 units including the master unit								
<b>PROTECTION FUNCTION</b>									
OVP	3~33V	3~33V	3~33V	4 ~ 44V	4 ~ 44V	4 ~ 44V	8~88V	8~88V	8~88V
OCV	3.6 ~39.6A	5~79.2A	5~118.8A	2.7 ~ 29.7A	5 ~ 59.4A	5 ~ 89.1A	1.35~14.85A	2.7~29.7A	4.05~44.55A
OHP	Activated by elevated internal temperatures								
<b>FRONT PANEL DISPLAY ACCURACY, 4 digits</b>									
Voltage	0.1%±20mV	0.1%±20mV	0.1%±20mV	0.1%+20mV	0.1%+20mV	0.1%+20mV	0.1%±20mV	0.1%±20mV	0.1%±20mV
Current	0.1%±40mA	0.1%±70mA	0.1%±100mA	0.1%+30mA	0.1%+60mA	0.1%+80mA	0.1%±20mA	0.1%±40mA	0.1%±50mA
<b>ENVIRONMENT CONDITION</b>									
Operation Temp	0°C ~ 50°C								
Storage Temp	-25°C ~ 70°C								
Operating Humidity	20% ~ 85% RH; No condensation								
Storage Humidity	90% RH or Less; No condensation								
<b>READ BACK TEMP COEFFICIENT</b>									
Voltage	100ppm/°C of rated output voltage : after a 30 minute warm-up								
Current	200ppm/°C of rated output current : after a 30 minute warm-up								
<b>OTHER</b>									
Analog Control Interface	Yes USB/LAN/GPIB-USB(Optional)/RS232-USB(Optional)								
Fan	With thermal sensing control								
POWER SOURCE	85VAC~265VAC, 47~63Hz, single phase								
DIMENSIONS & WEIGHT	71(W)x124(H) x350(D) mm ; Approx. 3kg	142(W)x124(H) x350(D) mm ; Approx. 5.3kg	214(W)x124(H) x350(D) mm ; Approx. 7.5kg	71(W)x124(H) x350(D) mm ; Approx. 3kg	142(W)x124(H) x350(D) mm ; Approx. 5.3kg	214(W)x124(H) x350(D) mm ; Approx. 7.5kg	71(W)x124(H) x350(D) mm ; Approx. 3kg	142(W)x124(H) x350(D) mm ; Approx. 5.3kg	214(W)x124(H) x350(D) mm ; Approx. 7.5kg

ORDERING INFORMATION	
PSW 30-36	(0~30V/0~36A/360W) Multi-Range DC Power Supply
PSW 30-72	(0~30V/0~72A/720W) Multi-Range DC Power Supply
PSW 30-108	(0~30V/0~108A/1080W) Multi-Range DC Power Supply
PSW 40-27	(0~40V/0~27A/360W) Multi-Range DC Power Supply
PSW 40-54	(0~40V/0~54A/720W) Multi-Range DC Power Supply
PSW 40-81	(0~40V/0~81A/1080W) Multi-Range DC Power Supply
PSW 80-13.5	(0~80V/0~13.5A/360W) Multi-Range DC Power Supply
PSW 80-27	(0~80V/0~27A/720W) Multi-Range DC Power Supply
PSW 80-40.5	(0~80V/0~40.5A/1080W) Multi-Range DC Power Supply
PSW 160-7.2	(0~160V/0~7.2A/360W) Multi-Range DC Power Supply
PSW 160-14.4	(0~160V/0~14.4A/720W) Multi-Range DC Power Supply
PSW 160-21.6	(0~160V/0~21.6A/1080W) Multi-Range DC Power Supply
PSW 250-4.5	(0~250V/0~4.5A/360W) Multi-Range DC Power Supply
PSW 250-9	(0~250V/0~9A/720W) Multi-Range DC Power Supply
PSW 250-13.5	(0~250V/0~13.5A/1080W) Multi-Range DC Power Supply
PSW 800-1.44	(0~800V/0~1.44A/360W) Multi-Range DC Power Supply
PSW 800-2.88	(0~800V/0~2.88A/720W) Multi-Range DC Power Supply
PSW 800-4.32	(0~800V/0~4.32A/1080W) Multi-Range DC Power Supply

ACCESSORIES	
CD-ROM x 1 (Programming Manual, User Manual), GTL-123 Test Lead x 1 (for PSW 30V/40V/80V/160V), Power Cord x 1 (Region dependent), GTL-240 USB Cable " L " Type x 1, PSW-004 Basic Accessories Kit x 1 (for PSW 30V/40V/80V/160V), Includes : M4 Terminal screws and washers x 2, Air Filter x 1, Analog control protection dummy x 1, Analog control lock lever x 1, M8 terminal bolts, nuts and washers x 2	
PSW-008 Basic Accessories kit for PSW 250V/800V models	PSW-011 Output terminal cover for 250V/800V models
PSW-009 Output terminal cover for 30V/40V/80V/160V models	PSW-012 High voltage output terminal for 250V/800V model
OPTIONAL ACCESSORIES	
PSW-001 Accessory Kit	GRA-410-J Rack Mount Kit (JIS)
PSW-002 Simple IDC Tool	GRA-410-E Rack Mount Kit (EIA)
PSW-003 Contact Removal Tool	PSW-010 Large filter (Type II/III)
PSW-005 Cable for 2 Units of PSW-Series in Series Mode Connection (for PSW 30V/40V/80V/160V)	CUG-001 GPIB to USB Adaptor
PSW-006 Cable for 2 Units of PSW-Series in Parallel Mode Connection	CUR-001A USB to RS-232 Cable, 300mm
PSW-007 Cable for 3 Units of PSW-Series in Parallel Mode Connection	
GET-001 Extended Terminal with max. 30A (for PSW 30V/40V/80V/160V)	
GET-002 Extended Terminal with max. 10A (for PSW 250V/800V)	
GET-005 Extended European Terminal with max. 20A (for PSW 30V/40V/80V/160V)	
GTL-130 Test lead : 2 x red, 2 x black (for PSW 250V/800V)	
GTL-248 GPIB Cable, Double Shielded, 2000mm	
GTL-250 GPIB Cable, Double Shielded, 600mm	

SPECIFICATIONS									
	PSW 160-7.2	PSW 160-14.4	PSW 160-21.6	PSW 250-4.5	PSW 250-9	PSW 250-13.5	PSW 800-1.44	PSW 800-2.88	PSW 800-4.32
<b>OUTPUT RATING</b>									
Voltage	0 ~ 160V	0 ~ 160V	0 ~ 160V	0 ~ 250V	0 ~ 250V	0 ~ 250V	0 ~ 800V	0 ~ 800V	0 ~ 800V
Current	0 ~ 7.2A	0 ~ 14.4A	0 ~ 21.6A	0 ~ 4.5A	0 ~ 9A	0 ~ 13.5A	0 ~ 1.44A	0 ~ 2.88A	0 ~ 4.32A
Power	360W	720W	1080W	360W	720W	1080W	360W	720W	1080W
<b>REGULATION(CV)</b>									
Load Line	85mV 83mV	85mV 83mV	85mV 83mV	130mV 128mV	130mV 128mV	130mV 128mV	405mV 403mV	405mV 403mV	405mV 403mV
<b>REGULATION(CC)</b>									
Load Line	12.2mA 12.2mA	19.4mA 19.4mA	26.6mA 26.6mA	9.5mA 9.5mA	14mA 14mA	18.5mA 18.5mA	6.44mA 6.44mA	7.88mA 7.88mA	9.32mA 9.32mA
<b>RIPPLE &amp; NOISE (Noise Bandwidth 20MHz; Ripple Bandwidth=1MHz)</b>									
CV p-p	60mV	80mV	100mV	80mV	100mV	120mV	150mV	200mV	200mV
CV rms	12mV	15mV	20mV	15mV	15mV	15mV	30mV	30mV	30mV
CC rms	15mA	30mA	45mA	10mA	20mA	30mA	5mA	10mA	15mA
<b>PROGRAMMING ACCURACY</b>									
Voltage	0.1% +100mV	0.1% +100mV	0.1% +100mV	0.1%+200mV	0.1%+200mV	0.1%+200mV	0.1%+400mV	0.1%+400mV	0.1%+400mV
Current	0.1% + 5mA	0.1% +15mA	0.1% +20mA	0.1%+5mA	0.1%+10mA	0.1%+15mA	0.1%+2mA	0.1%+4mA	0.1%+6mA
<b>MEASUREMENT ACCURACY</b>									
Voltage	0.1% +100mV	0.1% +100mV	0.1% +100mV	0.1%+200mV	0.1%+200mV	0.1%+200mV	0.1%+400mV	0.1%+400mV	0.1%+400mV
Current	0.1% +5mA	0.1% +15mA	0.1% +20mA	0.1%+5mA	0.1%+10mA	0.1%+15mA	0.1%+2mA	0.1%+4mA	0.1%+6mA
<b>RESPONSE TIME</b>									
Raise Time	100ms	100ms	100ms	100ms	100ms	100ms	150ms	150ms	150ms
Fall Time(Full Load)	100ms	100ms	100ms	150ms	150ms	150ms	300ms	300ms	300ms
Fall Time(No Load)	1000ms	1000ms	1000ms	1200ms	1200ms	1200ms	2000ms	2000ms	2000ms
Load Transient Recover Time (Load change from 50~100%)	2ms	2ms	2ms	2ms	2ms	2ms	2ms	2ms	2ms
<b>PROGRAMMING RESOLUTION (By PC Remote Control Mode)</b>									
Voltage	3mV	3mV	3mV	5mV	5mV	5mV	14mV	14mV	14mV
Current	1mA	2mA	3mA	1mA	1mA	1mA	1mA	1mA	1mA
<b>MEASUREMENT RESOLUTION (By PC Remote Control Mode)</b>									
Voltage	3mV	3mV	3mV	5mV	5mV	5mV	14mV	14mV	14mV
Current	1mA	2mA	3mA	1mA	1mA	1mA	1mA	1mA	1mA
<b>SERIES AND PARALLEL CAPABILITY</b>									
Parallel Operation	Up to 3 units including the master unit			3	3	3	3	3	3
Series Operation	Up to 2 units including the master unit			N/A	N/A	N/A	N/A	N/A	N/A
<b>PROTECTION FUNCTION</b>									
OVP	16~176V	16~176V	16~176V	20~275V	20~275V	20~275V	20~880V	20~880V	20~880V
OCV	0.72~7.92A	1.44~15.84A	2.16~23.76A	0.45~4.95A	0.9~9.9A	1.35~14.85A	0.144~1.584A	0.288~3.168A	0.432~4.752A
OHP	Activated by elevated internal temperatures								
<b>FRONT PANEL DISPLAY ACCURACY, 4 digits</b>									
Voltage	0.1%±100mV	0.1%±100mV	0.1%±100mV	0.1%±200mV	0.1%±200mV	0.1%±200mV	0.1%±400mV	0.1%±400mV	0.1%±400mV
Current	0.1%±5mA	0.1%±30mA	0.1%±30mA	0.1%±5mA	0.1%±10mA	0.1%±20mA	0.1%±2mA	0.1%±4mA	0.1%±6mA
<b>ENVIRONMENT CONDITION</b>									
Operation Temp	0°C ~ 50°C								
Storage Temp	-25°C ~ 70°C								
Operating Humidity	20% ~ 85% RH; No condensation								
Storage Humidity	90% RH or Less; No condensation								
<b>READ BACK TEMP COEFFICIENT</b>									
Voltage	100ppm/°C of rated output voltage : after a 30 minute warm-up								
Current	200ppm/°C of rated output current : after a 30 minute warm-up								
<b>OTHER</b>									
Analog Control	Yes								
Interface	USB/LAN/GPIB-USB(Optional)/RS232-USB(Optional)								
Fan	With thermal sensing control								
POWER SOURCE	85VAC~265VAC, 47~63Hz, single phase								
DIMENSIONS & WEIGHT	71(W)x124(H) x350(D) mm ; Approx. 3kg	142(W)x124(H) x350(D) mm ; Approx. 5.3kg	214(W)x124(H) x350(D) mm ; Approx. 7.5kg	71(W)x124(H) x350(D) mm ; Approx. 3kg	142(W)x124(H) x350(D) mm ; Approx. 5.3kg	214(W)x124(H) x350(D) mm ; Approx. 7.5kg	71(W)x124(H) x350(D) mm ; Approx. 3kg	142(W)x124(H) x350(D) mm ; Approx. 5.3kg	214(W)x124(H) x350(D) mm ; Approx. 7.5kg

Specifications subject to change without notice. SW-0000GD5BH

Global Headquarters

**GOOD WILL INSTRUMENT CO., LTD.**

No.7-1, Jhongsing Road, Tucheng Dist., New Taipei City 236, Taiwan  
T +886-2-2268-0389 F +886-2-2268-0639  
E-mail: marketing@goodwill.com.tw

China Subsidiary

**GOOD WILL INSTRUMENT (SUZHOU) CO., LTD.**

No. 521, Zhujiang Road, Snd, Suzhou Jiangsu 215011 China  
T +86-512-6661-7177 F +86-512-6661-7277

Malaysia Subsidiary

**GOOD WILL INSTRUMENT (SEA) SDN. BHD.**

No. 1-3-18, Elit Avenue, Jalan Mayang Pasir 3,  
11950 Bayan Baru, Penang, Malaysia  
T +604-6111122 F +604-6115225

Europe Subsidiary

**GOOD WILL INSTRUMENT EURO B.V.**

De Run 5427A, 5504DG Veldhoven, THE NETHERLANDS  
T +31(0)40-2557790 F +31(0)40-2541194

U.S.A. Subsidiary

**INSTEK AMERICA CORP.**

5198 Brooks Street Montclair, CA 91763, U.S.A.  
T +1-909-399-3535 F +1-909-399-0819

Japan Subsidiary

**TEXIO TECHNOLOGY CORPORATION.**

7F Towa Fudosan Shin Yokohama Bldg., 2-18-13 Shin  
Yokohama, Kohoku-ku, Yokohama, Kanagawa,  
222-0033 Japan  
T +81-45-620-2305 F +81-45-534-7181

Korea Subsidiary

**GOOD WILL INSTRUMENT KOREA CO., LTD.**

Room No.503, Gyeonginro 775 (Mullae-Dong 3Ga,  
Ace Hightech-City B/D 1Dong), Yeongduengpo-Gu,  
Seoul 150093, Korea.  
T +82-2-3439-2205 F +82-2-3439-2207

India Subsidiary

**GW INSTEK INDIA LLP.**

No.2707/B&C, 1st Floor UNNATHI Building,  
E-Block, Sahakara Nagar, Bengaluru-560 092, India  
T +91-80-6811-0600 F +91-80-6811-0626

**GW INSTEK**

Simply Reliable



Website



Facebook



LinkedIn