



## Ethernet switch managed gigabit ICRL-M-16RJ45/4CP-G-DIN

- 16 Gigabit Ethernet RJ45 ports, 4 Gigabit Ethernet RJ45 ports shared with 4 SFP ports
- Layer 2 Network Performance
- Redundant power input with a input power range of 10 to 60VDC
- IP20 with an extreme operating temperature range of -40 to 75°C
- Suitable for PROFINET IO and EtherNet/IP

Ethernet managed gigabit switch with 20 RJ45 ports with 4 shared SFP ports



### Function

The ICRL-M-16RJ45/4CP-G-DIN is a managed industrial Ethernet Switch with sixteen RJ45 Gigabit ports and four Gigabit RJ45/SF Combo ports. The rugged, industrial design and extended operating temperature range make the switch ideal for installations where reliability is critical, including factory automation, harsh environments, locations that may be prone to electrical magnetic interference and deployment in outdoor cabinets.

The robust suite of management features, advanced access control and security, and availability of up to 20 ports with SFP fiber options ensures the ICRL-M-16RJ45/4CP-G-DIN meets the high demands of mission-critical industrial networking applications.

### Dimensions

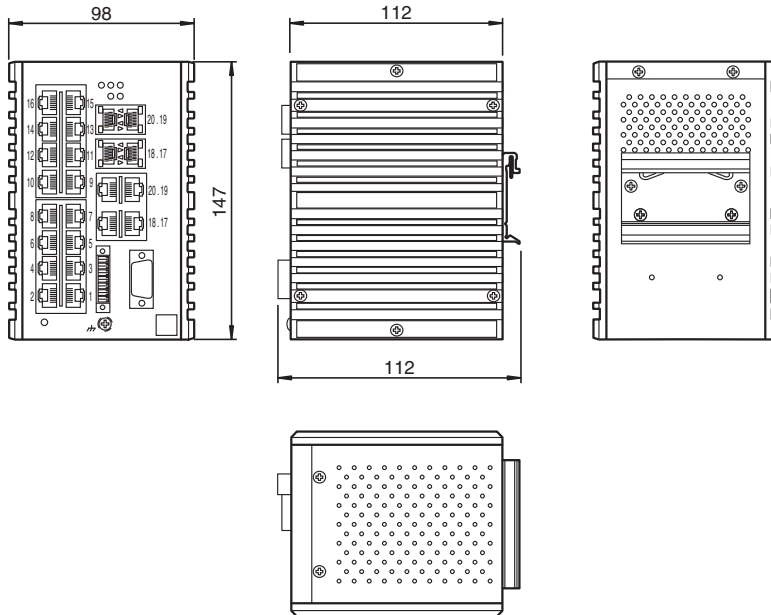

### Technical Data

#### General specifications

UL File Number E185778

#### Functional safety related parameters

MTBF 35.2 years

Release date: 2021-04-19 Date of issue: 2021-04-19 Filename: 70114060\_eng.pdf

Refer to "General Notes Relating to Pepperl+Fuchs Product Information".

Pepperl+Fuchs Group  
www.pepperl-fuchs.com

USA: +1 330 486 0001  
fa-info@us.pepperl-fuchs.com

Germany: +49 621 776 1111  
fa-info@de.pepperl-fuchs.com

Singapore: +65 6779 9091  
fa-info@sg.pepperl-fuchs.com

**PF** PEPPERL+FUCHS

## Technical Data

Ethernet Interface	
Connection type	RJ45 , SFP
Auto-MDI(-X)	yes
Autonegotiation	yes
Ethernet Interface	Industrial Ethernet
Transfer rate	16 - 10BASE-T, 100BASE-TX, 1000BASE-T, 4 - SFP 100/1000 Mbps
Management	IPv4, IPv6, Console, HTTP, HTTPS, PortVision DX, SFTP, SNMP (v1, v2c, and v3), SSH, Telnet, TFTP
MIB	MIB-II, Bridge MIB, Ethernet-like-MIB, VLAN MIB, IGMP MIB, Private MIB
Monitoring	LLDP, Port Mirroring, RMON
Multicast	IGMP Query, IGMP Snooping, GMRP
Network performance	CFM, Jumbo Frames, QoS, CoSQueue Mapping, DSCP Priority Mapping
Network redundancy	STP, RSTP, MSTP, ERPS, Redundant Ring, LACP, Static Port Aggregation
Network services	DHCP Server (with Option 82), NTP, IEEE 1588 PTPv2 over UDP/IP
Notifications	E-Mail, Fault Relay, SNMP Traps, Syslog
Safety	RADIUS, TACACS+, DHCP Snooping, IP Source Guard, Dynamic ARP Inspection, MAC-Based Port Security
Traffic filtering	Storm Control (Broadcast, Multicast, and DLF), Rate Control, VLAN, Private VLAN, QinQ Tunneling, GVRP, IP Filtering, MAC Filtering, ARP Filtering
Cable type	Category 5e or better
Switch properties	
Hardware watchdog timer	10 s reset timer
MAC address table size	16K
Operating mode	Store and forward
Packet buffer size	1.5M Bytes shared memory for packet buffer with intelligent memory management unit for burst data traffic
Priority queues	4
VLAN entries	IEEE 802.1Q Tag VLAN with 256 VLAN Entries and provides 2K GVRP entries; 3 VLAN link modes- Trunk mode, Hybrid mode and Link access mode
SFP support	100BASE-FX Fiber, 1000BASE-SX/LX/LHX/XD/ZX
Standards	
IEEE 802.3 10BASE-T	yes
IEEE 802.3u 100BASE-TX	yes
IEEE 802.3x Flow Control and Back-pressure	yes
IEEE 802.1p Class of Service (CoS)	yes
IEEE 802.3ab 1000BASE-T	yes
IEEE 802.1AB Link Layer Discovery Protocol (LLDP)	yes
IEEE 802.1Q VLAN and GVRP	yes
IEEE 802.1D-2004 Rapid Spanning Tree Protocol (RSTP)	yes
IEEE 802.1s Multiple Spanning Tree Protocol (MSTP)	yes
IEEE 802.3ad Link Aggregation Protocol (LACP)	yes
IEEE802.1ad QinQ Tunneling	yes
IEEE 802.1x Port Based Network Access Protocol	yes
ITU-T G.8032 ERPS	yes
<b>Indicators/operating means</b>	
LED indication	see manual
<b>Electrical specifications</b>	
Rated operating voltage	U <sub>e</sub> 10 ... 60 V DC
Power consumption	25 W
General information	Redundant power, relay output rating 0.5A Max. @ 24V DC
Nominal voltage	24 V DC

Release date: 2021-04-19 Date of issue: 2021-04-19 Filename: 70114060\_eng.pdf

Refer to "General Notes Relating to Pepperl+Fuchs Product Information".

Pepperl+Fuchs Group  
www.pepperl-fuchs.comUSA: +1 330 486 0001  
fa-info@us.pepperl-fuchs.comGermany: +49 621 776 1111  
fa-info@de.pepperl-fuchs.comSingapore: +65 6779 9091  
fa-info@sg.pepperl-fuchs.com

**PEPPERL+FUCHS**

**Technical Data**

<b>Inputs/Outputs</b>	
Number/Type	16 x RJ45 , 4 x RJ45 shared with SFP ports , 4 SFP ports
<b>Directive conformity</b>	
Electromagnetic compatibility	
Directive 2014/30/EU	EN 61000-6-2, IEC 61000-6-2 , EN 61000-6-4, IEC 61000-6-4
<b>Standard conformity</b>	
Electrical safety	CSA C22.2 No. 60950 / CSA C22.2 No. 60950/UL60950
Emitted interference	CISPR 22 , FCC Part 15 Subpart B Class A , EN61000-6-4, IEC61000-6-4
Noise immunity	EN61000-6-2, IEC61000-6-2
<b>Ambient conditions</b>	
Ambient temperature	-40 ... 75 °C (-40 ... 167 °F)
Storage temperature	-40 ... 85 °C (-40 ... 185 °F)
Relative humidity	max. 95 %
Altitude	0 ... 3048 m
<b>Mechanical specifications</b>	
Housing length	112 mm
Housing width	114 mm
Housing height	147 mm
Degree of protection	IP30
Connection	Power Supply Terminal Block (6-pin) Ethernet 16 x RJ45, 4 x RJ45 shared SFP, 4 x SFP
Material	
Housing	aluminium, black
Mass	1380 g
Construction type	Cabinet module
Mounting	DIN rail or direct panel mounting

**Wiring Diagram**

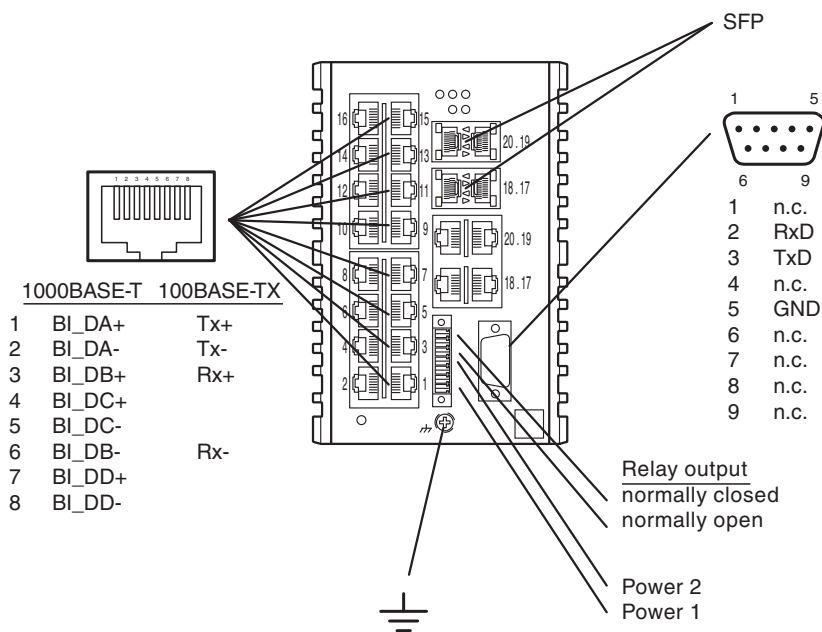





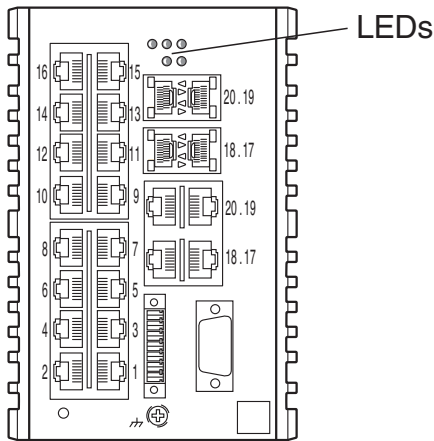









Release date: 2021-04-19 Date of issue: 2021-04-19 Filename: 70114060\_eng.pdf

Indication





















Accessories

	<b>V45-G-C5-GN1M-PUR-E1S</b>	Ethernet bus cable male cordset single-ended RJ45, 4-pin, PUR cable green, Cat5e, shielded, UL approved, drag chain suitable
	<b>V45-G-C5-GN3M-PUR-E1S</b>	Ethernet bus cable male cordset single-ended RJ45, 4-pin, PUR cable green, Cat5e, shielded, UL approved, drag chain suitable
	<b>V45-G-C5-GN10M-PUR-E1S</b>	Ethernet bus cable male cordset single-ended RJ45, 4-pin, PUR cable green, Cat5e, shielded, UL approved, drag chain suitable
	<b>V45-G-C5-GN1M-PUR-E1S-V45-G</b>	Ethernet bus cable RJ45 to RJ45 PROFINET-coded, 4-pin, PUR cable green, Cat5e, shielded, UL approved, drag chain suitable
	<b>V45-G-C5-GN3M-PUR-E1S-V45-G</b>	Ethernet bus cable RJ45 to RJ45 PROFINET-coded, 4-pin, PUR cable green, Cat5e, shielded, UL approved, drag chain suitable
	<b>V45-G-C5-GN10M-PUR-E1S-V45-G</b>	Ethernet bus cable RJ45 to RJ45 PROFINET-coded, 4-pin, PUR cable green, Cat5e, shielded, UL approved, drag chain suitable
	<b>V45-G-C5-GN20M-PUR-E1S-V45-G</b>	Ethernet bus cable RJ45 to RJ45 PROFINET-coded, 4-pin, PUR cable green, Cat5e, shielded, UL approved, drag chain suitable
	<b>SFP-M-2KM-F-N</b>	Multi-mode 2KM 100BASE-FX Fast Ethernet Fiber SFP
	<b>SFP-M-2KM-F-W</b>	Multi-mode 2KM 100BASE-FX Fast Ethernet Fiber SFP
	<b>SFP-M-2KM-G-W</b>	Multi-mode 2KM 100BASE-LX Gigabit Ethernet Fiber SFP
	<b>SFP-M-550M-G-N</b>	Multi-mode 550m 1000BASE-SX Gigabit Ethernet Fiber SFP
	<b>SFP-M-550M-G-W</b>	Multi-mode 550m 1000BASE-SX Gigabit Ethernet Fiber SFP
	<b>SFP-S-100KM-F-W</b>	Single-mode 100KM 100BASE-ZX Fast Ethernet Fiber SFP
	<b>SFP-S-10KM-G-N</b>	Single-mode 10KM 1000BASE-LX Gigabit Ethernet Fiber SFP

Release date: 2021-04-19 Date of issue: 2021-04-19 Filename: 70114060\_eng.pdf

## Accessories

	<b>SFP-S-10KM-G-W</b>	Single-mode 10KM 1000BASE-LX Gigabit Ethernet Fiber SFP
	<b>SFP-S-10KM-G-W-BIDI-A</b>	Single-mode BiDi-A 10KM 1000BASE-LX Gigabit Ethernet Fiber SFP
	<b>SFP-S-10KM-G-W-BIDI-B</b>	Single-mode BiDi-B 10KM 1000BASE-LX Gigabit Ethernet Fiber SFP
	<b>SFP-S-110KM-G-W</b>	Single-mode 110KM 1000BASE-UZX Gigabit Ethernet Fiber SFP
	<b>SFP-S-120KM-F-W</b>	Single-mode 120KM 100BASE-FX Fast Ethernet Fiber SFP
	<b>SFP-S-20KM-F-W</b>	Single-mode 20KM 100BASE-FX Fast Ethernet Fiber SFP
	<b>SFP-S-20KM-F-W-BIDI-A</b>	Single-mode BiDi-A 20KM 100BASE-BX Fast Ethernet Fiber SFP
	<b>SFP-S-20KM-F-W-BIDI-B</b>	Single-mode BiDi-B 20KM 100BASE-BX Fast Ethernet Fiber SFP
	<b>SFP-S-20KM-G-W</b>	Single-mode 20KM 1000BASE-LX Gigabit Ethernet Fiber SFP
	<b>SFP-S-20KM-G-W-BIDI-A</b>	Single-mode BiDi-A 20KM 1000BASE-LX Gigabit Ethernet Fiber SFP
	<b>SFP-S-20KM-G-W-BIDI-B</b>	Single-mode BiDi-B 20KM 1000BASE-LX Gigabit Ethernet Fiber SFP
	<b>SFP-S-30KM-F-N</b>	Single-mode 30KM 100BASE-LX Fast Ethernet Fiber SFP
	<b>SFP-S-30KM-F-W</b>	Single-mode 30KM 100BASE-LX Fast Ethernet Fiber SFP
	<b>SFP-S-30KM-G-W</b>	Single-mode 30KM 1000BASE-LX Gigabit Ethernet Fiber SFP
	<b>SFP-S-40KM-G-W</b>	Single-mode 40KM 1000BASE-EX Gigabit Ethernet Fiber SFP
	<b>SFP-S-50KM-G-W</b>	Single-mode 50KM 1000BASE-XD Gigabit Ethernet Fiber SFP
	<b>SFP-S-60KM-F-W</b>	Single-mode 60KM 100BASE-ZX Fast Ethernet Fiber SFP
	<b>SFP-S-70KM-G-W</b>	Single-mode 70KM 1000BASE-LX Gigabit Ethernet Fiber SFP
	<b>SFP-S-90KM-G-W</b>	Single-mode 90KM 1000BASE-ZX Gigabit Ethernet Fiber SFP

Release date: 2021-04-19 Date of issue: 2021-04-19 Filename: 70114060\_eng.pdf

Refer to "General Notes Relating to Pepperl+Fuchs Product Information".

Pepperl+Fuchs Group  
www.pepperl-fuchs.comUSA: +1 330 486 0001  
fa-info@us.pepperl-fuchs.comGermany: +49 621 776 1111  
fa-info@de.pepperl-fuchs.comSingapore: +65 6779 9091  
fa-info@sg.pepperl-fuchs.com

**PEPPERL+FUCHS**