

Optical reading head

PCV100-F200-B17-V1D-6011-8203

- Traverse distance up to 100 km
- Non-contact positioning on Data Matrix code tape
- Mechanically rugged: no wearing parts, long operating life, maintenance-free
- High resolution and precise positioning, especially for facilities with curves and switch points as well as inclines and declines.
- PROFINET interface
- Integrated switch

Read head for incident light positioning system



Dimensions

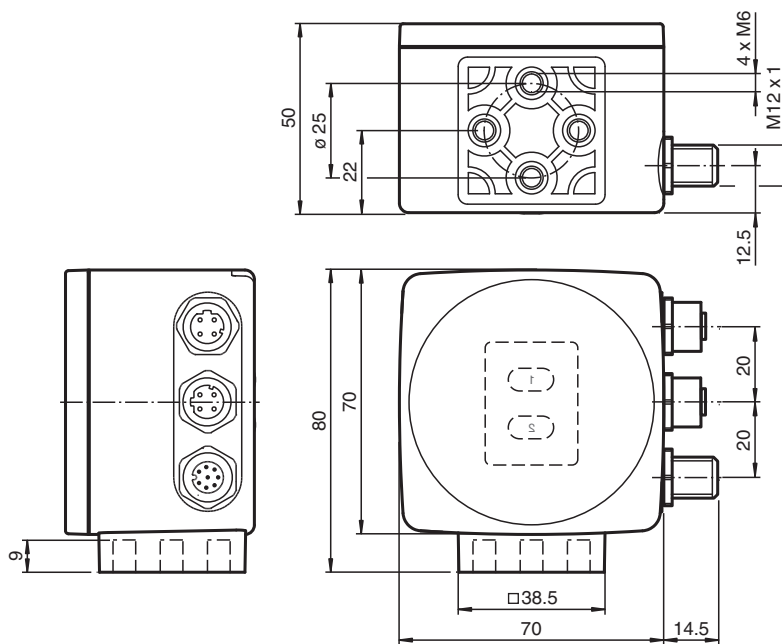

Technical Data

General specifications

Passage speed	v	≤ 6 m/s
Measuring range		max. 100000 m
Light type		Integrated LED lightning (red)
Scan rate		40 s ⁻¹
Read distance		100 mm
Depth of focus		± 40 mm
Reading field		60 mm x 35 mm
Ambient light limit		100000 Lux
Accuracy		± 0.2 mm

Release date: 2020-12-04 Date of issue: 2020-12-04 Filename: 70103187_eng.pdf

Refer to "General Notes Relating to Pepperl+Fuchs Product Information".

Pepperl+Fuchs Group
www.pepperl-fuchs.com

USA: +1 330 486 0001
fa-info@us.pepperl-fuchs.com

Germany: +49 621 776 1111
fa-info@de.pepperl-fuchs.com

Singapore: +65 6779 9091
fa-info@sg.pepperl-fuchs.com

 PEPPERL+FUCHS

Technical Data

Nominal ratings			
Camera			
Type		CMOS , Global shutter	
Processor			
Clock pulse frequency		600 MHz	
Speed of computation		4800 MIPS	
Functional safety related parameters			
MTTF _d		101 a	
Mission Time (T _M)		20 a	
Diagnostic Coverage (DC)		0 %	
Indicators/operating means			
LED indication		7 LEDs (communication, alignment aid, status information)	
Electrical specifications			
Operating voltage	U _B	15 ... 30 V DC , PELV	
No-load supply current	I ₀	max. 400 mA	
Power consumption	P ₀	6 W	
Interface			
Interface type		100 BASE-TX	
Protocol		PROFINET IO Real-Time (RT) Conformance class B Netload Class II	
Transfer rate		100 MBit/s	
Interface 2			
Interface type		USB Service	
Input			
Input type		1 function input 0-level: -U _B or unwired 1-level: +8 V ... +U _B , programmable	
Input impedance		≥ 27 kΩ	
Output			
Output type		1 to 3 switch outputs , programmable , short-circuit protected	
Switching voltage		Operating voltage	
Switching current		150 mA each output	
Conformity			
Shock resistance		EN 60068-2-27:2009	
Vibration resistance		EN 60068-2-6:2008	
Emitted interference		EN 61000-6-4:2007+A1:2011	
Noise immunity		EN 61000-6-2:2005	
Photobiological safety		exempt group according EN 62471:2008	
Approvals and certificates			
CE conformity		CE	
UL approval		cULus Listed, General Purpose, Class 2 Power Source, Type 1 enclosure	
CCC approval		CCC approval / marking not required for products rated ≤36 V	
Ambient conditions			
Operating temperature		0 ... 60 °C (32 ... 140 °F) , -20 ... 60 °C (-4 ... 140 °F) (noncondensing; prevent icing on the lens!)	
Storage temperature		-20 ... 85 °C (-4 ... 185 °F)	
Relative humidity		90 % , noncondensing	
Mechanical specifications			
Connection type		8-pin, M12x1 connector, standard (supply+IO) 4-pin, M12x1 socket, D-coded (LAN) 4-pin, M12x1 socket, D-coded (LAN)	
Housing width		70 mm	
Housing height		70 mm	
Housing depth		50 mm	
Degree of protection		IP67	
Material			

Release date: 2020-12-04 Date of issue: 2020-12-04 Filename: 70103187_eng.pdf

Refer to "General Notes Relating to Pepperl+Fuchs Product Information".

Pepperl+Fuchs Group
www.pepperl-fuchs.comUSA: +1 330 486 0001
fa-info@us.pepperl-fuchs.comGermany: +49 621 776 1111
fa-info@de.pepperl-fuchs.comSingapore: +65 6779 9091
fa-info@sg.pepperl-fuchs.com

PEPPERL+FUCHS

Technical Data

Housing	PC/ABS
Mass	approx. 200 g

Connection

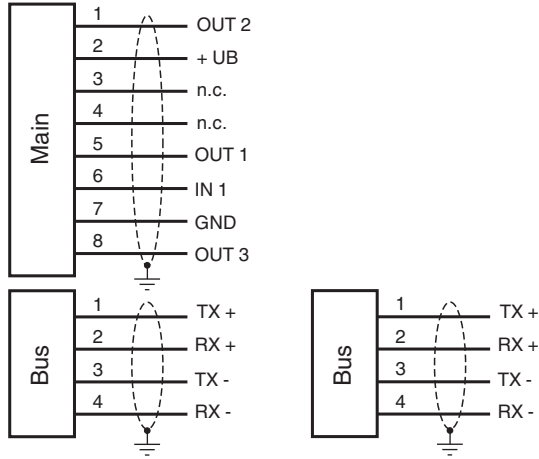

Connection Assignment

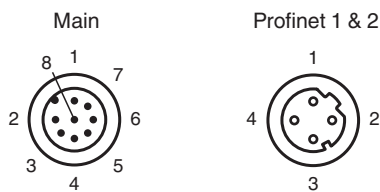

Characteristic Curve

Coordinates

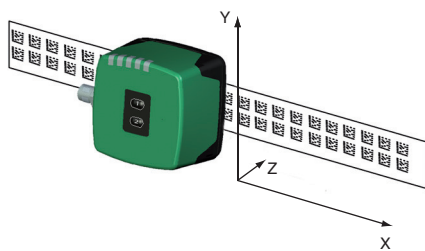



Release date: 2020-12-04 Date of issue: 2020-12-04 Filename: 70103187_eng.pdf

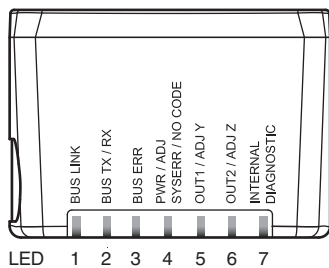
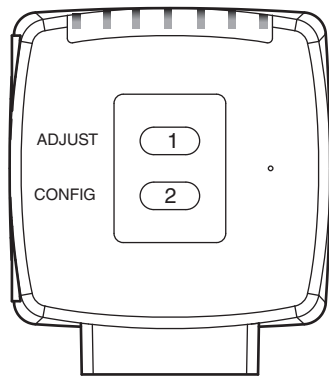





Indication



Matching System Components











	PCV-CR40	Coded repair tape for PCV system
	PCV-CR20	Coded repair tape for PCV system
	PCV*-CA10-* / PCV*-CA20-*	Data Matrix code tape

Accessories

	PCV-SC12	Grounding clip for PCV system
	PCV-LM25	Marker head for 25 mm code tape
	V1SD-G-2M-PUR-ABG-V1SD-G	Ethernet bus cable, M12 to M12, PUR cable 4-pin, CAT5e
	V1SD-G-5M-PUR-ABG-V1SD-G	Ethernet bus cable, M12 to M12, PUR cable 4-pin, CAT5e
	PCV-AG100	Alignment guide for PCV100-* read head
	PCV-MB1	Mounting bracket for PCV* read head
	V19-G-ABG-PG9-FE	Female connector, M12, 8-pin, shielded, field attachable

Release date: 2020-12-04 Date of issue: 2020-12-04 Filename: 70103187_eng.pdf

Accessories

	V19-G-ABG-PG9	Female connector, M12, 8-pin, shielded, field attachable
	PCV-SC12A	Grounding clip for PCV system
	V19-G-2M-PUR-ABG	Female cordset single-ended M12 straight A-coded, 8-pin, PUR cable grey, shielded
	V19-G-5M-PUR-ABG	Female cordset single-ended M12 straight A-coded, 8-pin, PUR cable grey, shielded
	V1SD-G-10M-PUR-ABG-V45-G	Connection cable, M12 to RJ-45, PUR cable 4-pin, CAT5e
	V1SD-G-2M-PUR-ABG-V45-G	Connection cable, M12 to RJ-45, PUR cable 4-pin, CAT5e
	V1SD-G-30M-PUR-ABG-V45-G	Connection cable, M12 to RJ-45, PUR cable 4-pin, CAT5e
	V1SD-G-5M-PUR-ABG-V45-G	Connection cable, M12 to RJ-45, PUR cable 4-pin, CAT5e
	Vision Configurator	Operating software for camera-based sensors
	PCV-KBL-V19-STR-USB	USB cable unit with power supply
	PCV-CM20-*-*SET	Event Marker for PCV system

Additional Information

General

The reading head is part of the positioning system in the method for measurement by Pepperl+Fuchs. It consists of a camera module and an integrated illumination unit among other things. The reading head detects position marks, which are put on an adhesive code band in the form of Data Matrix code. The mounting of the code band is as a rule stationary on a firm part of the plant (elevator shaft, overhead conveyor mounting rails...); that of the reading head is parallel on the moving "vehicle" (elevator car, overhead conveyor chassis...).

Mounting and commissioning

Mount the reading head such that its optical surface captures the optimal read distance to the code band (see Technical Data). The stability of the mounting and the guidance of the vehicle must be provided such that the depth of field of the reading head is not closed during operation. All reading heads can be optimally customized by parameterization for specific requirements.

Displays and Controls

The reading head allows visual function check and fast diagnosis with 7 indicator LEDs. The reading head has 2 buttons on the reverse of the device to activate the alignment aid and parameterization mode.

LEDs

LED	Color	Label	Meaning
1	green	BUS LINK	PROFINET communication active
2	yellow	BUS TX / RX	Data transfer
3	red	BUS ERR	PROFINET communication Error
4	red / green	PWR / ADJ SYSERR / NO CODE	Code recognized / not recognized, Error
5	yellow	OUT1/ADJ Y	Output 1, Alignment aid Y
6	yellow	OUT2/ADJ Z	Output 2, Alignment aid Z
7	red/green/yellow	INTERNAL DIAGNOSTIC	Internal diagnostics

Alignment aid for the Y and Z coordinates

The activation of the alignment aid is only possible within 10 minutes of switching on the reading head. The switchover from normal operation to "alignment aid operating mode is via button 1 on the reverse of the reading head.

- Press the button 1 for longer than 2 s. LED4 flashes green for a recognized code band. LED4 flashes red for an unrecognized code band.
- **Z coordinate:** If the distance of the camera to the code band too small, the yellow LED6 lights up. If the distance of the camera to the code band too large, the yellow LED6 lights up. Within the target range, the yellow LED6 flashes at the same time as the green LED4.
- **Y coordinate:** If the optical axis of the camera is too deep in relation to the middle of the code band, the yellow LED5 lights up. If the optical axis is too high, the yellow LED5 extinguishes. Within the target range, the yellow LED5 flashes at the same time as the green LED4.
- A short press on button 1 ends the alignment aid and the reading head changes to normal operation.