

# DATASHEET

## Circular Connector, Wire to Panel, Straight Female Plug and Panel Mount Male Socket 4 Contacts / M16

Version 10/23

Item no.: 2705571

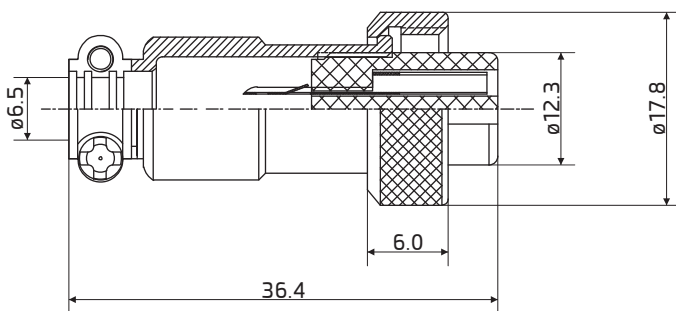

### Specification

Number of Contacts: 4  
Mating thread type: M16

### Material

Shell: Nickel plated Zinc Alloy  
Insulation: Black Bakelite  
Contact: Silver plated Copper

### Electrical

Operating voltage: 60V  
Rated current: 7 A  
Insulation resistance: 100 MΩ min.  
Contact resistance: 10 mΩ max.

### Environment

Operation temperature: -20 to 85°C  
Protect class: IP55  
Termination: Solder  
Suit Cable size: O.D. ø6.5mm max.  
Wire guide: AWG 16 - 14  
Conductor cross-section: 1.3 - 2.1mm<sup>2</sup>

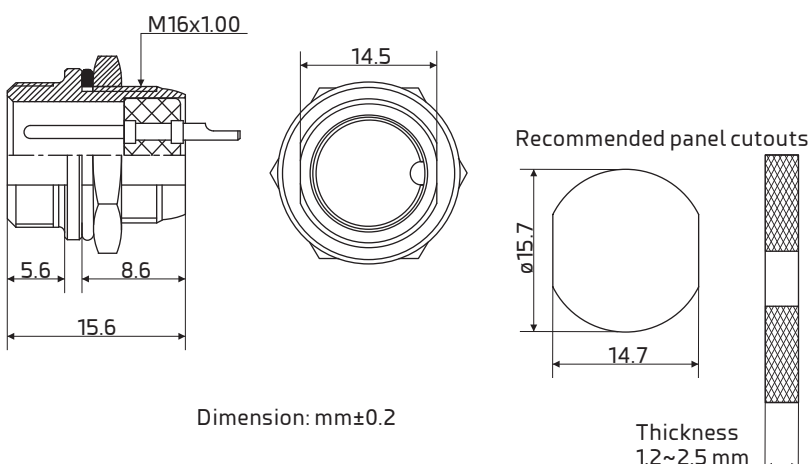

Dimension: mm±0.2

Thickness  
1.2~2.5 mm