

2324136-1 ✓ ACTIVE

AMP+ HVP800

TE Internal #: 2324136-1

Housing for Female Terminals, 1 Position, Sealable, Orange, Wire & Cable, Power & Signal, Cable Mount (Free-Hanging), AMP+ HVP800

[View on TE.com >](#)



Connectors > Automotive Connectors > Automotive Housings



Connector & Housing Type: **Housing for Female Terminals**

Mating Pin Diameter: **8 mm**

Number of Positions: **1**

Sealable: **Yes**

Hybrid Connector: **Yes**

Features

Product Type Features

Connector Shape	Rectangular
Connector & Housing Type	Housing for Female Terminals
Sealable	Yes
Hybrid Connector	Yes
Primary Locking Feature	Locking Lance
Connector & Contact Terminates To	Wire & Cable

Configuration Features

Blank Cavity Position	1
Number of Positions	1
Number of Rows	1

Electrical Characteristics

Operating Voltage	650 VDC
Nominal Voltage Architecture	650 V

Body Features



Cable Exit Angle	90°
Primary Product Color	Orange
Connector Code	A

Contact Features

Contact Size	1.2mm, 8mm
Contact Type	Socket
Mating Pin Diameter	8 mm
Contact Current Rating (Max)	200 A

Mechanical Attachment

Terminal Position Assurance	No
Mating Alignment Type	Keyed
Mating Alignment	With
Connector Mounting Type	Cable Mount (Free-Hanging)

Housing Features

Housing Material	PA
------------------	----

Dimensions

Connector Height	61.2 mm[2.409 in]
Product Width	59 mm[2.323 in]
Product Length	106.7 mm[4.201 in]

Usage Conditions

Operating Temperature (Max)	140 °C[284 °F]
Operating Temperature Range	-40 – 140 °C[-40 - 284 °F]

Operation/Application

Circuit Application	Power & Signal
---------------------	----------------

Industry Standards

Degree of Protection	IP2XB
Agency/Standard	LV214
UL Flammability Rating	UL 94V-0

Packaging Features

Packaging Method	Box
------------------	-----

Other

--	--



Connector Position Assurance Capable	Yes
--------------------------------------	-----

Product Compliance

[For compliance documentation, visit the product page on TE.com>](#)

EU RoHS Directive 2011/65/EU	Compliant
EU ELV Directive 2000/53/EC	Compliant
China RoHS 2 Directive MIIT Order No 32, 2016	No Restricted Materials Above Threshold
EU REACH Regulation (EC) No. 1907/2006	Current ECHA Candidate List: JUNE 2022 (224) Candidate List Declared Against: JUNE 2022 (224) Does not contain REACH SVHC
Halogen Content	BFR/CFR/PVC Free, but Br/Cl >900 ppm in other sources.
Solder Process Capability	Not reviewed for solder process capability

Product Compliance Disclaimer

This information is provided based on reasonable inquiry of our suppliers and represents our current actual knowledge based on the information they provided. This information is subject to change. The part numbers that TE has identified as EU RoHS compliant have a maximum concentration of 0.1% by weight in homogenous materials for lead, hexavalent chromium, mercury, PBB, PBDE, DBP, BBP, DEHP, DIBP, and 0.01% for cadmium, or qualify for an exemption to these limits as defined in the Annexes of Directive 2011/65/EU (RoHS2). Finished electrical and electronic equipment products will be CE marked as required by Directive 2011/65/EU. Components may not be CE marked. Additionally, the part numbers that TE has identified as EU ELV compliant have a maximum concentration of 0.1% by weight in homogenous materials for lead, hexavalent chromium, and mercury, and 0.01% for cadmium, or qualify for an exemption to these limits as defined in the Annexes of Directive 2000/53/EC (ELV). Regarding the REACH Regulation, the information TE provides on SVHC in articles for this part number is based on the latest European Chemicals Agency (ECHA) 'Guidance on requirements for substances in articles' posted at this URL: <https://echa.europa.eu/guidance-documents/guidance-on-reach>

Compatible Parts

 <p>TE Part # 2-2324108-1 1POS,P2P,HDR ASSY,COD A,UL94V-0</p>	 <p>TE Part # 2324108-1 1POS,P2P,HDR ASSY,COD A,UL94V-0</p>	 <p>TE Part # 2324108-2 1POS,PIN DIA 8.0,HDR ASSY,COD B</p>	 <p>TE Part # 2324108-3 1POS,PIN DIA 8.0,HDR ASSY,COD C</p>
--	--	--	--



TE Part # 2324108-4
1POS,PIN DIA 8.0,HDR ASSY,COD D



TE Part # 2324108-5
1POS,PIN DIA 8.0,HDR ASSY,COD E



TE Part # 2324108-6
1POS,PIN DIA 8.0,HDR ASSY,COD F



TE Part # 4-2324108-1
1POS,P2P,HDR ASSY,COD A,UL94V-0



TE Part # 5-2324108-1
1POS,P2P,HDR ASSY,COD A,UL94V-0

TE Part # 1-2324108-1
1POS,P2P,HDR ASSY,COD A,UL94V-0

TE Part # 1-2324108-2
1POS,PIN DIA 8.0,HDR ASSY,COD B

TE Part # 1-2324108-3
1POS,PIN DIA 8.0,HDR ASSY,COD C

TE Part # 1-2324108-4
1POS,PIN DIA 8.0,HDR ASSY,COD D

TE Part # 1-2324108-5
1POS,PIN DIA 8.0,HDR ASSY,COD E

TE Part # 1-2324108-6
1POS,PIN DIA 8.0,HDR ASSY,COD F

TE Part # 1-2324108-7
1POS,P2P,HDR ASSY,COD A,UL94V-0

TE Part # 2324108-7
1POS,P2P,HDR ASSY,COD A,UL94V-0

Also in the Series | **AMP+ HVP800**



Automotive Connector Caps & Covers (11)



Automotive Connector EMC Shielding (10)

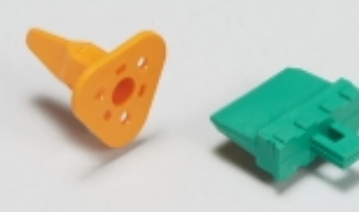

Automotive Connector Locks & Position Assurance(1)



Automotive Housings(103)



Automotive Seals & Cavity Plugs(5)

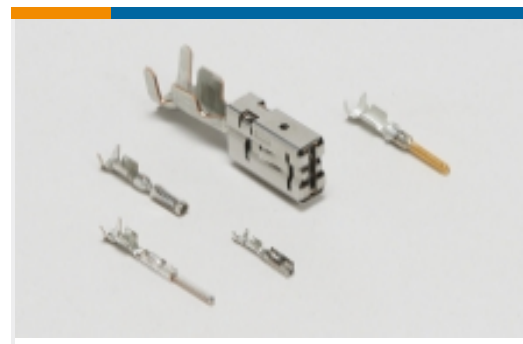

Automotive Terminals(7)



Electric, Hybrid & Fuel Cell Cable Assemblies(10)



High Voltage Wire Processing Equipment(25)



Other Automotive Connector Accessories(1)

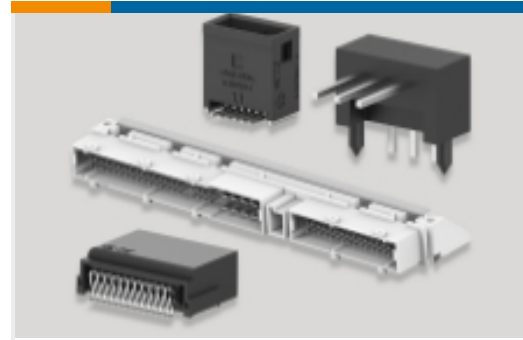

PCB Headers & Receptacles(56)

Customers Also Bought

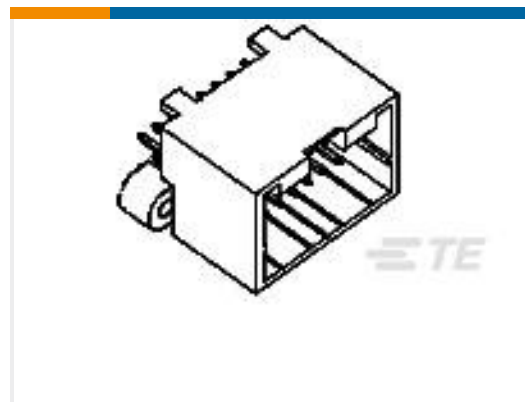

TE Part #174975-2
040 MLC CAP ASSY V 16P



TE Part #2141155-1
PROTEC. COVER 8MM HV,90DEG



TE Part #1-962919-1
TAB 5.8x0.8 CONTACT CS SWS Sn



TE Part #2098190-1
EVC500, RELAY, SPSTN



TE Part #936782-2
MT-II/JPT SLD 20P PLUG COVER



TE Part #2138602-1
RELAY,EVC135,24 VDC COIL,165mm WIRE



TE Part #1-2141166-1
3POS,8MM HV,REC HSG,90DEG,ASSY, SEALED



TE Part #2324136-2
1POS,P2P,SOC HSG ASSY,90DEG, COD B,50SQMM



TE Part #2350891-1
20POS,HYBRID,PIN HSG ASSY,SLD, COD A



TE Part #2357302-1
BACKSHELL,CONN KIT

Documents



Product Drawings

[1POS,P2P,SOC HSG ASSY,90DEG,COD A,50SQMM](#)

English

CAD Files

[3D PDF](#)

3D

Customer View Model

[ENG_CVM_CVM_2324136-1_A.2d_dxf.zip](#)

English

Customer View Model

[ENG_CVM_CVM_2324136-1_A.3d_igs.zip](#)

English

Customer View Model

[ENG_CVM_CVM_2324136-1_A.3d_stp.zip](#)

English

By downloading the CAD file I accept and agree to the [Terms and Conditions](#) of use.

Product Specifications

[Application Specification](#)

English