



**K-Type Marker**

TE Internal #: EC6417-000

Pre-Printed Markers, Tie-On, 65 Marker Size, Yellow, Straight Cut, K Printed Marking, Width 6 mm [.23 in], Black, Flexible PVC, K-Type Marker

[View on TE.com >](#)

Identification & Labeling > Pre-Printed Markers > K-Type Tie-On Markers



Marker Style: **Tie-On**

Marker Size: **65**

Compatible Cable Diameter Range: **4.2 – 7 mm [ .165 – .276 in ]**

Primary Product Color: **Yellow**

Marker Cut: **Straight**

[All K-Type Tie-On Markers \(123\)](#)

**Features**

**Body Features**

Marker Style	Tie-On
Marker Size	65
Primary Product Color	Yellow
Primary Product Material	Flexible PVC

**Dimensions**

Compatible Cable Diameter Range	4.2 – 7 mm [.165 – .276 in]
Product Width	6 mm [.23 in]

**Printer/Label Features**

Marker Cut	Straight
Printed Marking	K

**Packaging Features**

Packaging Method	Reel
Packaging Quantity	500

**Other**

Printed Marking Color	Black
-----------------------	-------



## Product Compliance





[For compliance documentation, visit the product page on TE.com>](#)

EU RoHS Directive 2011/65/EU	Compliant
EU ELV Directive 2000/53/EC	Compliant
China RoHS 2 Directive MIIT Order No 32, 2016	No Restricted Materials Above Threshold
EU REACH Regulation (EC) No. 1907/2006	Current ECHA Candidate List: JUNE 2022 (224) Candidate List Declared Against: JUNE 2022 (224) Does not contain REACH SVHC
Halogen Content	Not Low Halogen - contains Br or Cl > 900 ppm.
Solder Process Capability	Not applicable for solder process capability



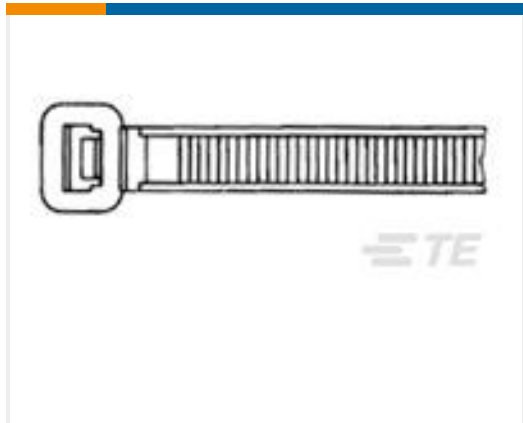

### Product Compliance Disclaimer

This information is provided based on reasonable inquiry of our suppliers and represents our current actual knowledge based on the information they provided. This information is subject to change. The part numbers that TE has identified as EU RoHS compliant have a maximum concentration of 0.1% by weight in homogenous materials for lead, hexavalent chromium, mercury, PBB, PBDE, DBP, BBP, DEHP, DIBP, and 0.01% for cadmium, or qualify for an exemption to these limits as defined in the Annexes of Directive 2011/65/EU (RoHS2). Finished electrical and electronic equipment products will be CE marked as required by Directive 2011/65/EU. Components may not be CE marked. Additionally, the part numbers that TE has identified as EU ELV compliant have a maximum concentration of 0.1% by weight in homogenous materials for lead, hexavalent chromium, and mercury, and 0.01% for cadmium, or qualify for an exemption to these limits as defined in the Annexes of Directive 2000/53/EC (ELV). Regarding the REACH Regulation, the information TE provides on SVHC in articles for this part number is based on the latest European Chemicals Agency (ECHA) 'Guidance on requirements for substances in articles' posted at this URL: <https://echa.europa.eu/guidance-documents/guidance-on-reach>

## Compatible Parts

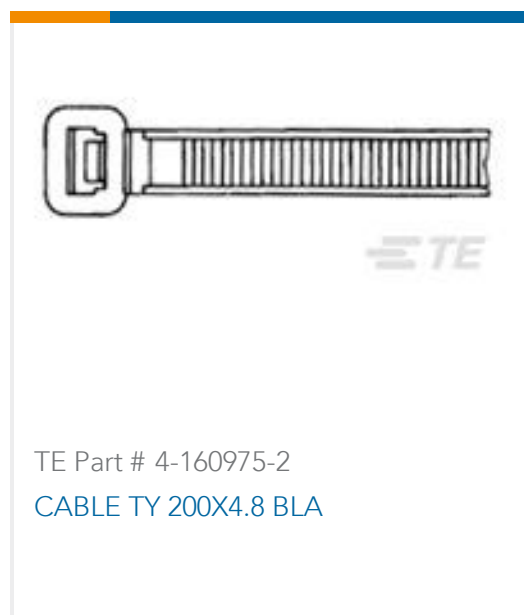
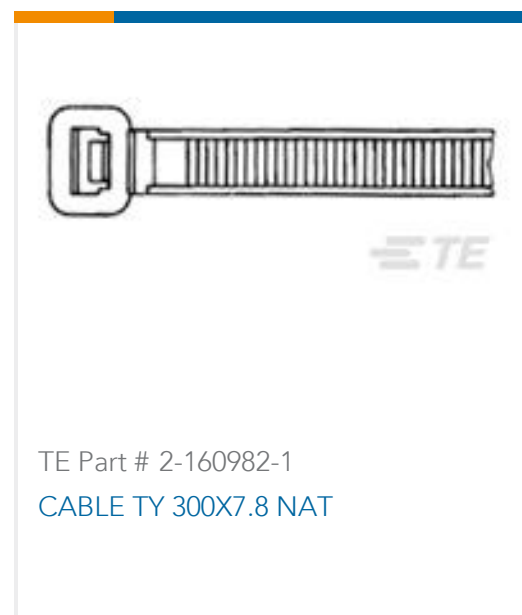
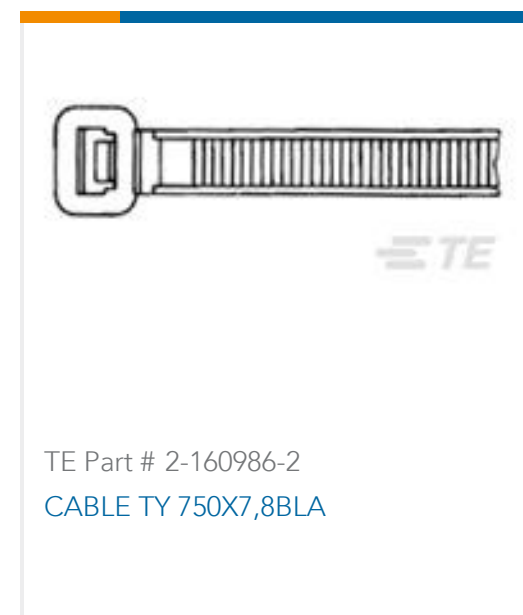
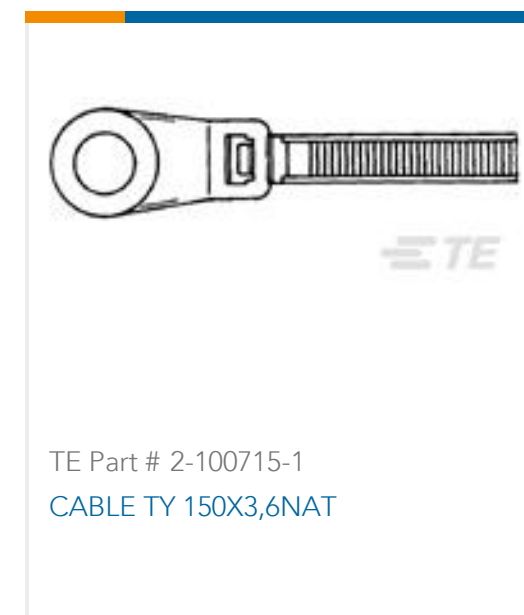
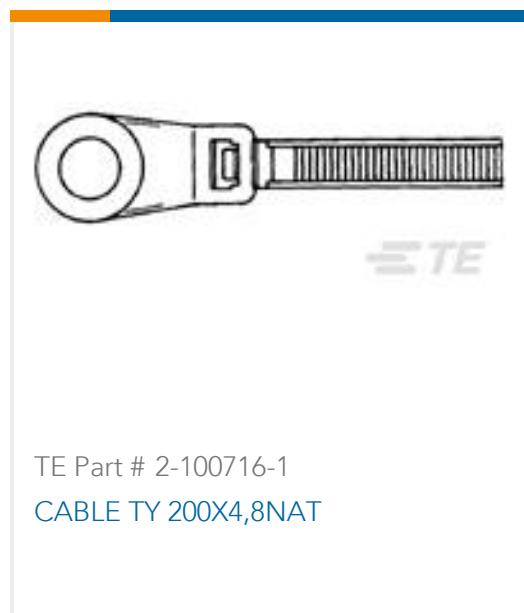
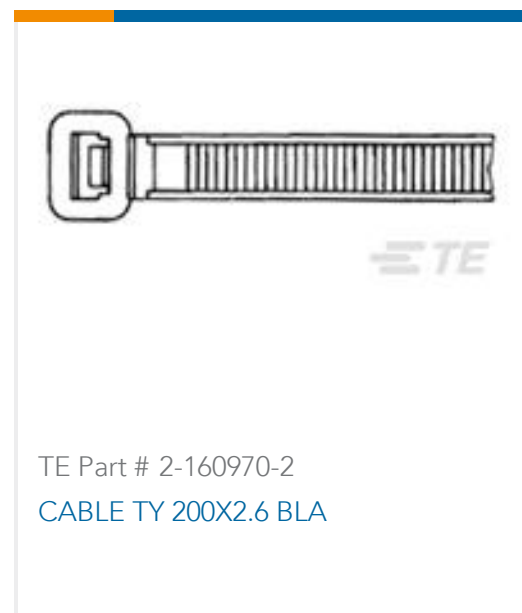
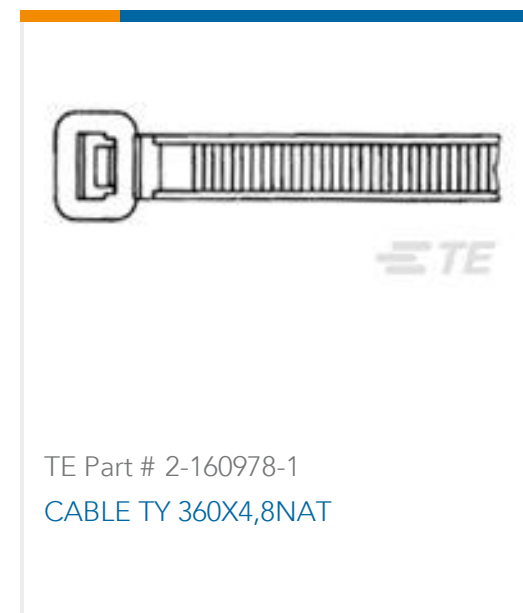
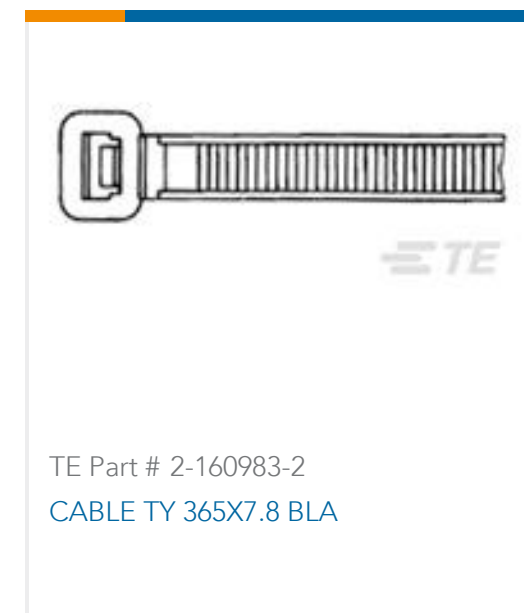
 <p>TE Part # 4-160968-1 CABLE TY 134X2.6 NAT</p>	 <p>TE Part # 2-160975-1 CABLE TY 200X4.8 NAT</p>	 <p>TE Part # 4-160968-2 CABLE TY 134X2.6 BLACK</p>	 <p>TE Part # 4-160971-2 CABLE TY 140X3.6 BLACK</p>
--	---	--	--

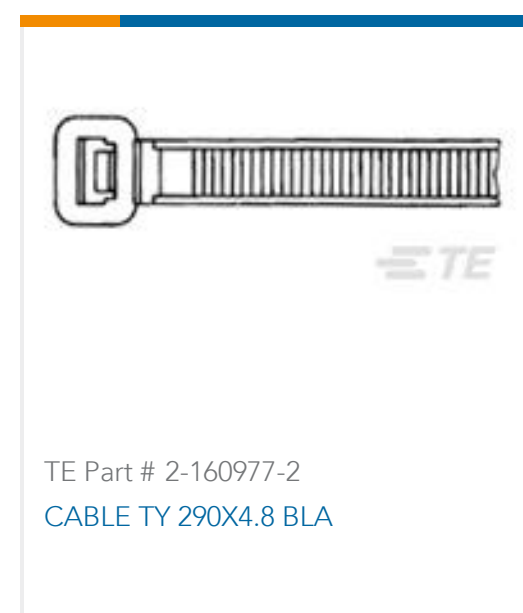
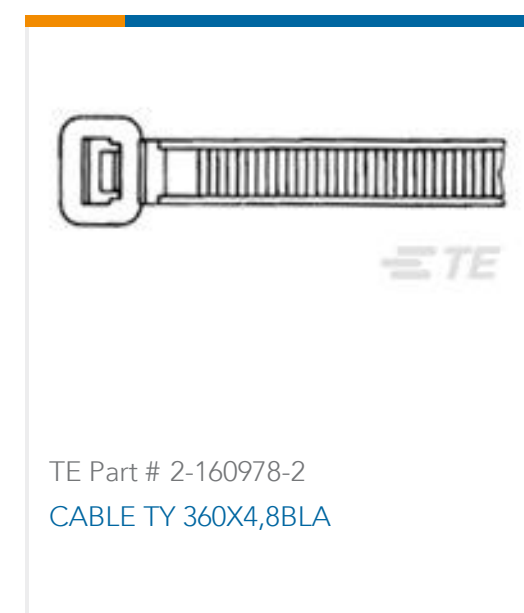
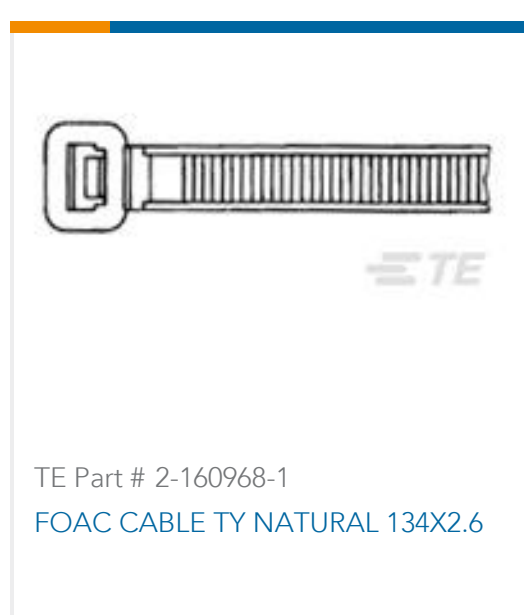

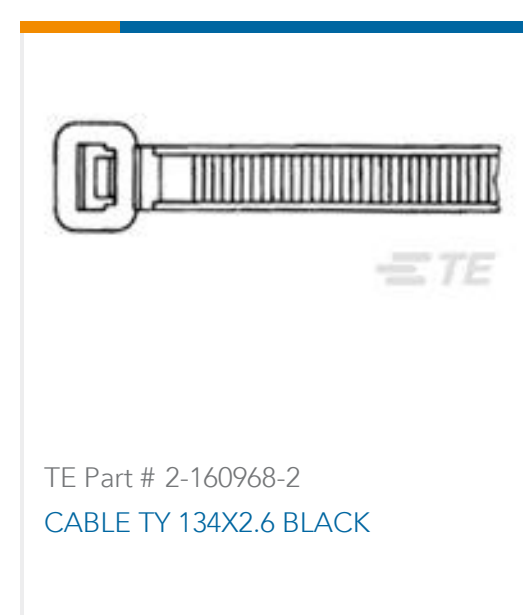
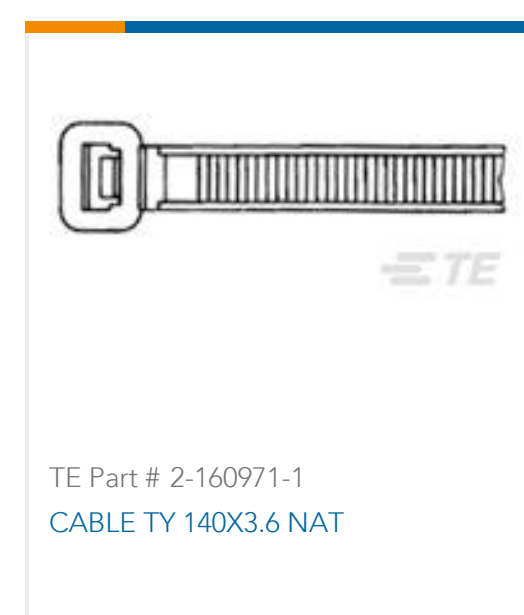
 <p>TE Part # 4-160975-2 CABLE TY 200X4.8 BLA</p>	 <p>TE Part # 2-160982-1 CABLE TY 300X7.8 NAT</p>	 <p>TE Part # 2-160986-2 CABLE TY 750X7,8BLA</p>	 <p>TE Part # 2-100715-1 CABLE TY 150X3,6NAT</p>
 <p>TE Part # 2-100716-1 CABLE TY 200X4,8NAT</p>	 <p>TE Part # 2-160970-2 CABLE TY 200X2.6 BLA</p>	 <p>TE Part # 2-160978-1 CABLE TY 360X4,8NAT</p>	 <p>TE Part # 2-160983-2 CABLE TY 365X7.8 BLA</p>
 <p>TE Part # 4-160970-2 CABLE TY 200X2.6 BLA</p>	 <p>TE Part # 4-160975-1 CABLE TY 200X4.8 NAT</p>	 <p>TE Part # 2-160977-2 CABLE TY 290X4.8 BLA</p>	 <p>TE Part # 2-160978-2 CABLE TY 360X4,8BLA</p>
 <p>TE Part # 2-160968-1 FOAC CABLE TY NATURAL 134X2.6</p>	 <p>TE Part # 2-160981-2 CABLE TY 240X7.8 BLACK</p>	 <p>TE Part # 2-160968-2 CABLE TY 134X2.6 BLACK</p>	 <p>TE Part # 2-160971-1 CABLE TY 140X3.6 NAT</p>

Also in the Series | **K-Type Marker**



Pre-Printed Markers(142)

Customers Also Bought



TE Part #9-1625963-2  
HSA5 5K6 5%

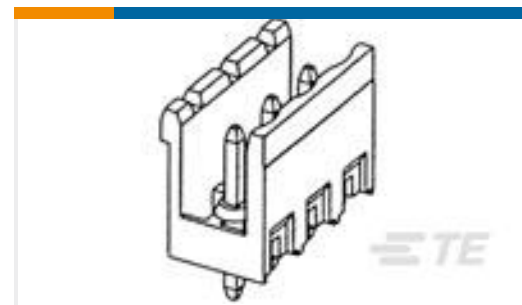

TE Part #1-282822-0  
TERMI-BLOK HEADER, ASSY90 10P.



TE Part #C282654001  
CGPT-32/16-2-SP



TE Part #EC6418-000  
K-Type Tie-On Markers



TE Part #6-1768034-6  
LKZ12E



TE Part #3-1879129-7  
RN 0402 1K62 0.1% 10PPM CUT LENGTH



TE Part #3776314001  
LSTT-25.4-2-SP

## Documents

### Product Drawings

13611210

English

### Datasheets & Catalog Pages

[K-TYPE Cable Makers](#)

English

[K-Type Markers](#)

English

### Product Specifications

[RW-2535 Specification for Pre-Printed Markers](#)

English