

KISSLING LIMIT SWITCH

Series G13 - from TE Connectivity (TE)

Switch meets specific shock and vibration levels

Environmentally sealed G13 limit switches can be integrated in many vehicles, which need to fulfill specific shock and vibration related requirements.

The KISSLING G13 limit switches meet high requirements for function and reliability under extreme conditions and become a valuable electric component in every vehicle application to ensure dependability.

The G13 limit switch complies i.a. with VG 95210 for shock and vibration and meets MIL-S-8805. Many of our G13 limit switches are also NSN (NATO Stock Number) listed

Features

- Military grade switch (VG 95210; MIL-S-8805)
- 1- and 2-pole versions
- Available with silver or gold contacts
- Shock (100G) and vibration (15G)
- Different actuator options available
- Aluminum housing; special versions with resistance to salt and seawater

Applications

- Commercial and military motor vehicles
- Military ground equipment and vehicles
- Plant and industrial engineering
- Marine applications
- Aviation ground support equipment

The locking function

Switches with locking mechanisms are manually operated switches with two switching positions. The change-over from switching position 1 to switching position 2 occurs whenever the actuation knob has been firmly pressed down.

The switch remains locked in switching position 2. Twisting the actuation knob in the direction of the arrow will release the locking mechanism and the switch will snap back into switching position 1.

Circuits

Single Pole

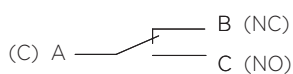

Double Pole

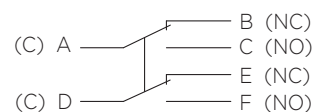

KISSLING LIMIT SWITCH

Series G13

Specification

Technical Data

Housing Material Special type	Al-alloy salt- and seawater resistance
Temperature range Special type	-55°C to +85°C -55°C to +125°C
Protection (connected)	IEC 60529, IP67 (0,2 bar, 5min)
Vibration i.a.w. MIL-STD-202; Method 204; Test condition B (10-2000 Hz)	15g
Shock i.a.w. MIL-STD-202; Method 213; Test condition I (6 ms; sawtooth)	100g
Insulation resistance i.a.w MIL-STD-202; Method 302; Test condition B (500 V; 1 min)	min. 100 MΩ
Dielectric withstanding voltage i.a.w MIL-STD-202; Method 301	1050VAC
max. approach speed at an angle of <30° Ball, Dome Roller	5m/min 30m/min
Operating force without looking	15 or 30 ± 5 N
Operating force with looking	approx. 60 ± 5 N
Endurance without looking i.a.w. MIL-S-8805; §4.8.26 (28 VDC; 1 Amps) i.a.w. MIL-S-8805; §4.8.26 (28 VDC; 5 Amps) only silver contacts	100.000 cycles 25.000 cycles
Endurance with looking i.a.w. MIL-S-8805; §4.8.26 (28 VDC; 5 Amps) only silver contacts mechanical	10.000 cycles 10.000 cycles

Switch inserts

Type	MS 24547-1 / silver		MS 24547-2 / gold	
	max.	min.	max.	min.
i.a.w. MIL-S-8805	up to +82°C		up to +82°C	
Electrical rating				
Resistive load	28VDC, 7A	15VDC, 10mA	28VDC, 1A	15VDC, 5mA
inductive load	28VDC, 7A	5VDC, 20mA	28VDC, 0.5A	5VDC, 10mA

Mounting dimensions

Mounting hole:
with locking ring

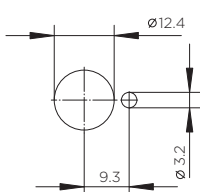

M12x1

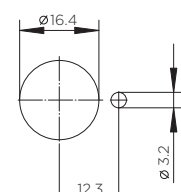

M16x1

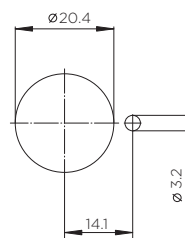

M20x1

KISSLING LIMIT SWITCH

Series G13

Technical drawings

Housing dimension mini

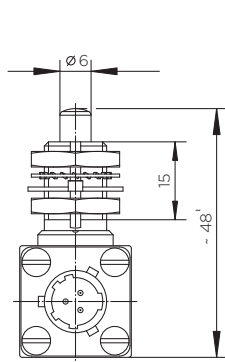
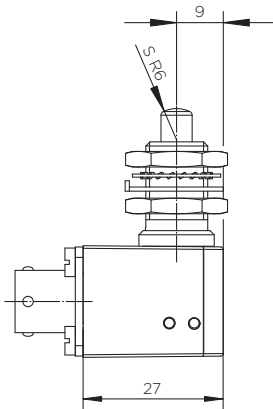

Example
G13-01-1183 (SILVER)
G13-01-1641 (GOLD)

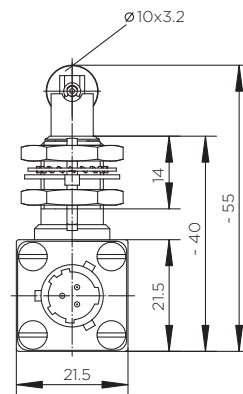

Example G13-01-1550 (GOLD)

Housing dimension small

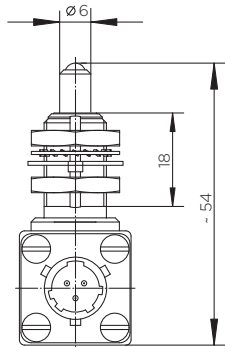
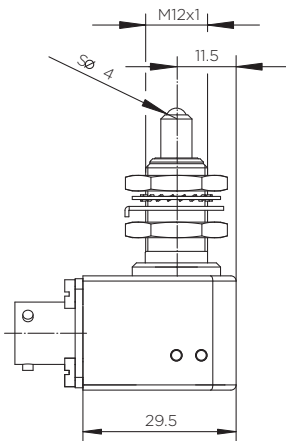

Example G13-01-1167 (SILVER)

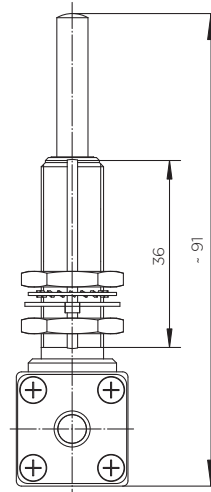

Example G13-01-1689 (SILVER)

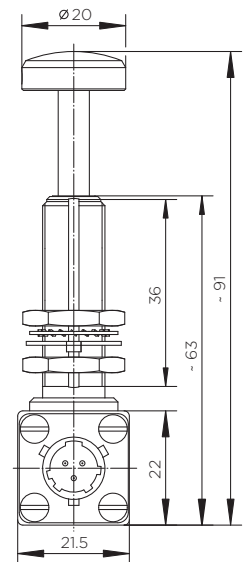

Example G13-01-1133 (SILVER)

Housing dimension large

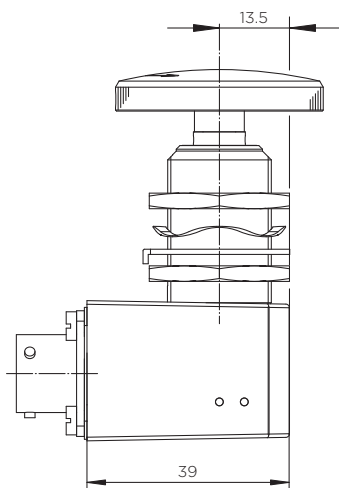

SWITCH WITH LOCKING MECHANISM

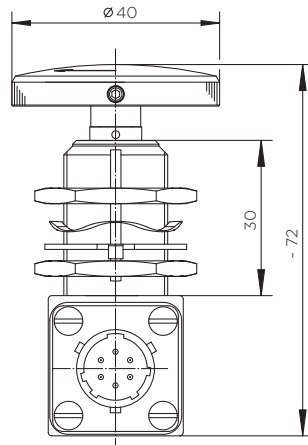

Example
G13-01-1220 (2-POLE, SILVER, RED)
G13-01-1629 (2-POLE, GOLD, RED)
G13-01-1585 (2-POLE, SILVER, GREEN)
G13-01-1470 (WITH CONNECTOR CECC 7520,
RESISTANT TO SALTWATER)

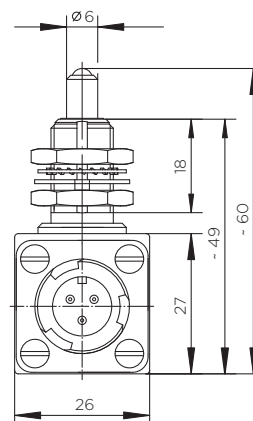

Example
G13-01-1097 (1-POLE, SILVER)

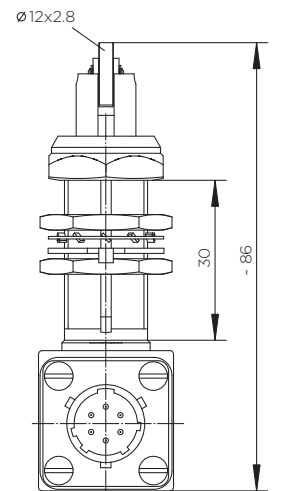

Example
G13-01-1365 (2-POLE, SILVER)

KISSLING LIMIT SWITCH

Series G13

Available types

Housing dimensions	Actuator	Length of thread mm	Mounting thread	Width across flats	Switch inserts	Connector (Standard) cable (option)
mini	Dome Roller	14 - 18	M12	SW17	single pole	H8-3APN VG 95328/ MIL-C-26482
small	Ball Dome Manual	18 - 36	M12	SW17	single pole	H8-3APN VG 95328/ MIL-C-26482
large	Ball	14 - 36	M12	SW17	single or double pole	A10-SL-3PN VG 95234 A10-98PN VG 96912 C10-6PN VG 95328/ MIL-C-26482 MIL-C-D38999
	Ball	18 - 30	M16	SW22		
	Roller	14 - 30	M16	SW22		
	Manual with locking mechanism red, green, black	30	M20	SW27		

te.com

TE Connectivity, TE, TE connectivity (logo) and KISSLING (word) are trademarks owned or licensed by the TE Connectivity family of companies. All other logos, products and/or company names referred to herein might be trademarks of their respective owners.

The information given herein, including drawings, illustrations and schematics which are intended for illustration purposes only, is believed to be reliable. However, TE Connectivity makes no warranties as to its accuracy or completeness and disclaims any liability in connection with its use. TE Connectivity's obligations shall only be as set forth in TE Connectivity's Standard Terms and Conditions of Sale for this product and in no case will TE Connectivity be liable for any incidental, indirect or consequential damages arising out of the sale, resale, use or misuse of the product. Users of TE Connectivity products should make their own evaluation to determine the suitability of each such product for the specific application.

© 2020 TE Connectivity | All Rights Reserved.

K1166743 | Version 08/2020