

40595 ✓ ACTIVE

TE Internal #: 40595

Ring Terminals & Spade Terminals, Ring Tongue, 18 – 14 AWG

Wire Size, .8 – 2 mm² Wire Size, 1624 – 4106 CMA Wire Size, Stud Size #10

[View on TE.com >](#)



Terminals & Splices > Ring Terminals & Spade Terminals

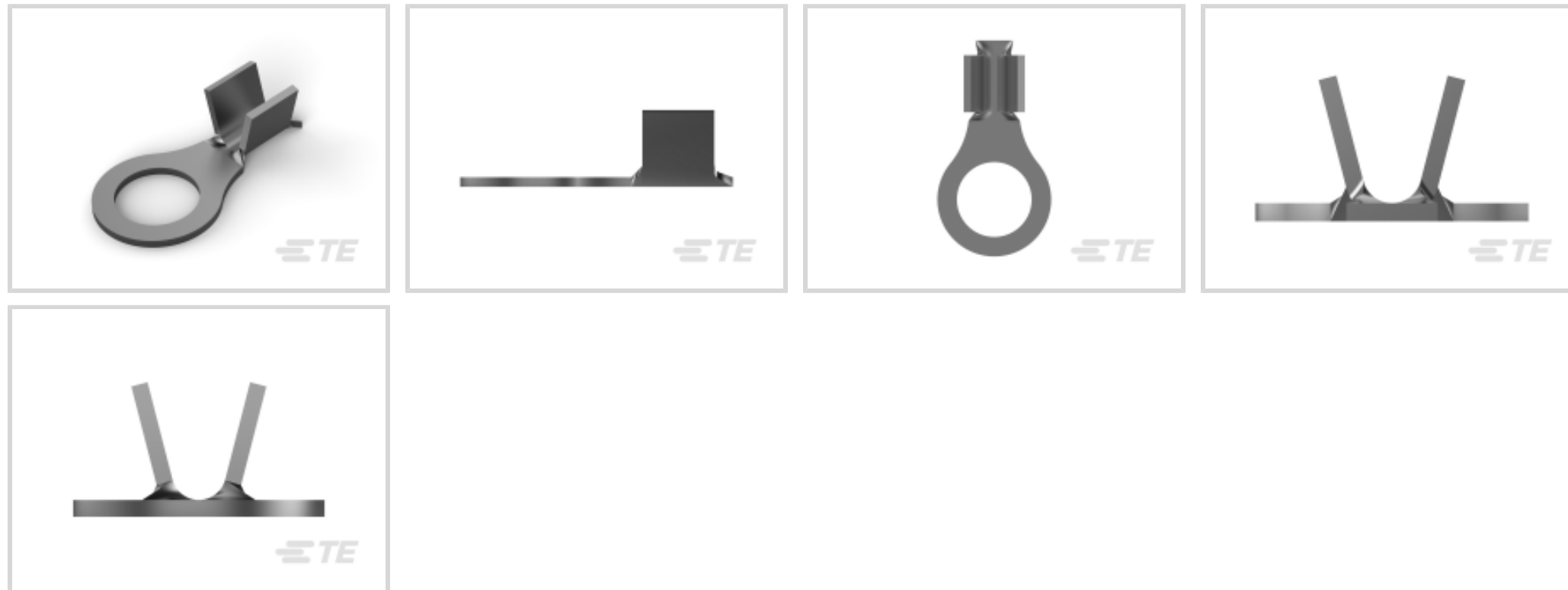

Ring & Spade Terminal Type: **Ring Tongue**

Wire Size: **1624 – 4106 CMA**

Stud Size: **#10**

Features

Product Type Features

Shape Description	Circular/Oval
Stud Size	#10
Sealable	No
Compatible With Discrete Wire Type	Stranded
Wire Insulation Support Retention Type	Non-Insulation Support

Configuration Features

Number of Holes	1
Terminal Angle	180 °

Body Features

Inspection Slot	No
Weight per Piece	.358 g

Contact Features

Contact Base Material	Brass
Ring & Spade Terminal Type	Ring Tongue
Barrel Type	Open
Terminal Orientation	Straight



Terminal Plating Material	Tin
Contact Underplating Material	None

Mechanical Attachment

Wire Insulation Support	Without
-------------------------	---------

Dimensions

Wire Size	1624 – 4106 CMA
Stud Diameter	4.82 mm[.19 in]
Tongue Thickness	.51 mm[.02 in]
Overall Product Length	13.72 mm[.54 in]
Barrel Inside Diameter	1.65 mm[.065 in]

Usage Conditions

Insulation Option	Uninsulated
Operating Temperature Range	-40 – 110 °C[-40 – 230 °F]

Operation/Application

Compatible With Wire Base Material	Copper
Heavy Duty	No

Industry Standards

Government Qualified	No
----------------------	----

Packaging Features

Packaging Quantity	20000
Packaging Method	Strip/Reel

Product Compliance

[For compliance documentation, visit the product page on TE.com>](#)

EU RoHS Directive 2011/65/EU	Compliant
EU ELV Directive 2000/53/EC	Compliant
China RoHS 2 Directive MIIT Order No 32, 2016	No Restricted Materials Above Threshold
EU REACH Regulation (EC) No. 1907/2006	Current ECHA Candidate List: JUNE 2022 (224) Candidate List Declared Against: JUNE 2022 (224) Does not contain REACH SVHC
Halogen Content	Low Halogen - Br, Cl, F, I < 900 ppm per homogenous material. Also BFR/CFR/PVC

Free











Solder Process Capability

Not applicable for solder process capability

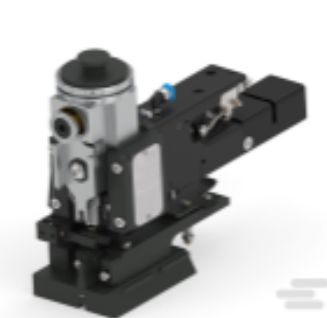
Product Compliance Disclaimer

This information is provided based on reasonable inquiry of our suppliers and represents our current actual knowledge based on the information they provided. This information is subject to change. The part numbers that TE has identified as EU RoHS compliant have a maximum concentration of 0.1% by weight in homogenous materials for lead, hexavalent chromium, mercury, PBB, PBDE, DBP, BBP, DEHP, DIBP, and 0.01% for cadmium, or qualify for an exemption to these limits as defined in the Annexes of Directive 2011/65/EU (RoHS2). Finished electrical and electronic equipment products will be CE marked as required by Directive 2011/65/EU. Components may not be CE marked. Additionally, the part numbers that TE has identified as EU ELV compliant have a maximum concentration of 0.1% by weight in homogenous materials for lead, hexavalent chromium, and mercury, and 0.01% for cadmium, or qualify for an exemption to these limits as defined in the Annexes of Directive 2000/53/EC (ELV). Regarding the REACH Regulation, the information TE provides on SVHC in articles for this part number is based on the latest European Chemicals Agency (ECHA) 'Guidance on requirements for substances in articles' posted at this URL: <https://echa.europa.eu/guidance-documents/guidance-on-reach>

Compatible Parts

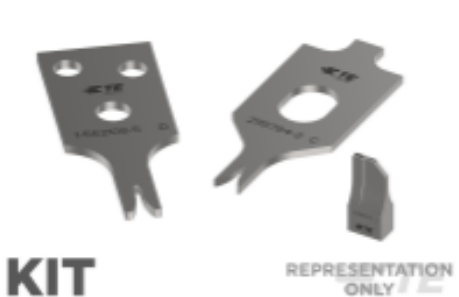
 <p>TE Part # 42185-2 RING 22-16 .125 .020TPBR</p>	 <p>TE Part # 1-61795-0 RING 18-14 105-145 #10 025TPBR</p>	 <p>TE Part # 2-2150736-1 OCEAN-2.0-APPLICATOR-E-120F</p>	 <p>TE Part # 2-2150736-2 OCEAN-2.0-APPLICATOR-E-120FA</p>
 <p>TE Part # 2150736-1 OCEAN-2.0-APPLICATOR-E-120F</p>	 <p>TE Part # 2150736-2 OCEAN-2.0-APPLICATOR-E-120FA</p>	 <p>TE Part # 350568-1 SPADE SNAP-ON 020TPBR #8</p>	 <p>TE Part # 61142-2 RING 18-14 6 020TPBR</p>
 <p>TE Part # 7-2150736-1 OCEAN-2.0-APPLICATOR-E-120F</p>	 <p>TE Part # 7-2150736-2 OCEAN-2.0-APPLICATOR-E-120FA</p>	 <p>TE Part # 7-2150736-7 OCEAN_2.0_SPARE_PART_KIT-120F</p>	

Customers Also Bought

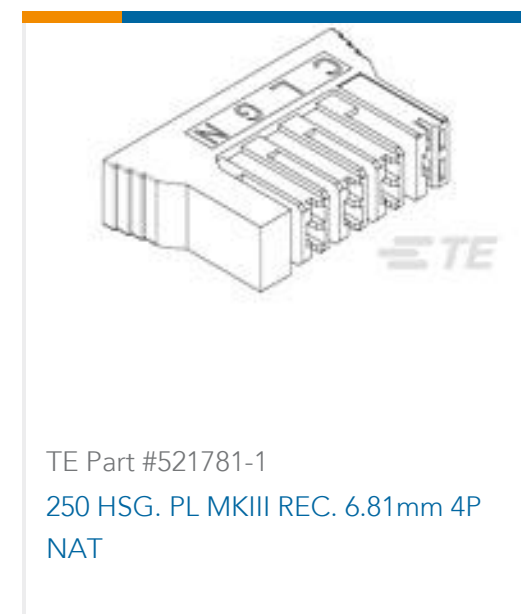

Documents

Product Drawings

RING TERMINAL 18-14 AWG TPBR

English

CAD Files

3D PDF

3D

Customer View Model

[ENG_CVM_CVM_40595_BJ_c-40595-bj.2d_dxf.zip](#)

English

Customer View Model

[ENG_CVM_CVM_40595_BJ_c-40595-bj.3d_igs.zip](#)

English

Customer View Model

[ENG_CVM_CVM_40595_BJ_c-40595-bj.3d_stp.zip](#)

English

By downloading the CAD file I accept and agree to the [Terms and Conditions](#) of use.

Product Specifications



Engineering Report

English