

5-1377175-6 ✓ ACTIVE

PLASTI-GRIP

TE Internal #: 5-1377175-6

Ring Terminals & Spade Terminals, Ring Tongue, 16 – 14 AWG

Wire Size, 1.25 – 2 mm<sup>2</sup> Wire Size, 2050 – 5180 CMA Wire Size, Stud

Size M10, PLASTI-GRIP

[View on TE.com >](#)



Terminals & Splices > Ring Terminals & Spade Terminals

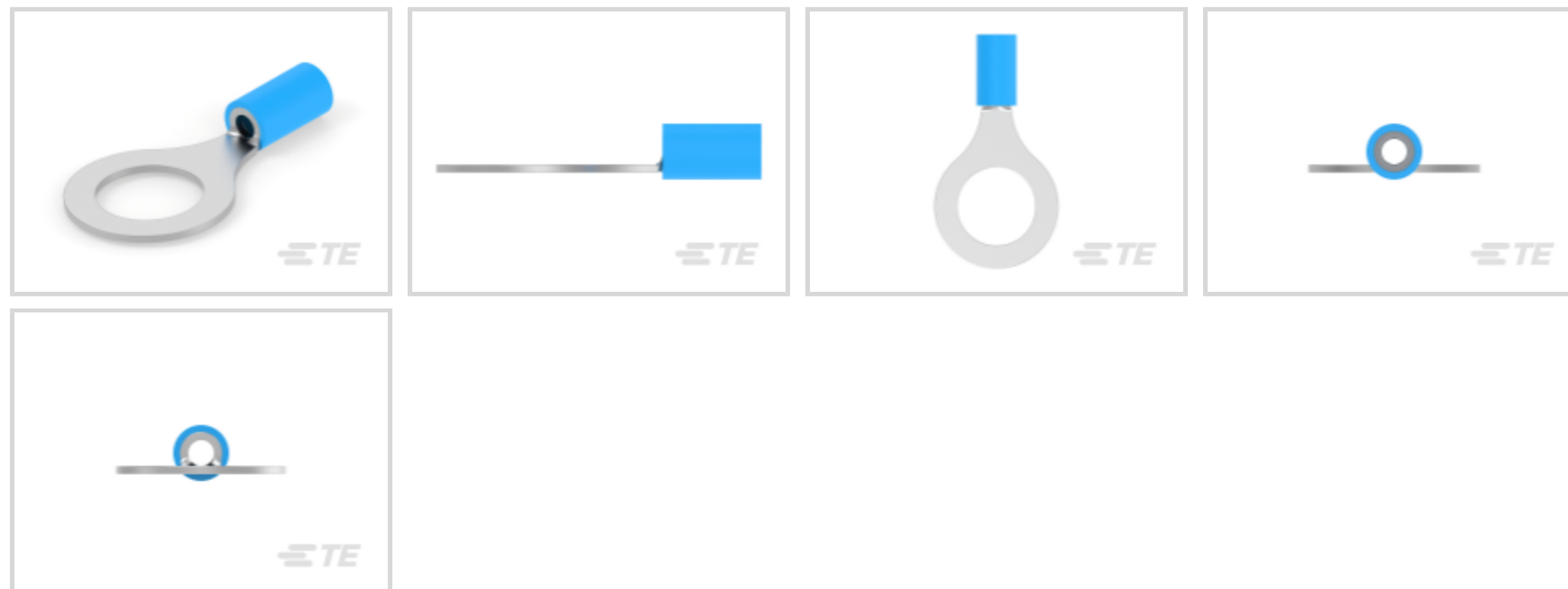

Ring & Spade Terminal Type: **Ring Tongue**

Wire Size: **2050 – 5180 CMA**

Stud Size: **M10**

## Features

### Product Type Features

Shape Description	RING-043
Stud Size	M10
Sealable	No
Wire Insulation Support Retention Type	Insulation Support

### Configuration Features

Terminal Angle	180 °
----------------	-------

### Electrical Characteristics

Voltage (Max)	600 V
---------------	-------

### Body Features

Weight per Piece	18.505 g [.6526 oz]
------------------	---------------------

### Contact Features

Ring & Spade Terminal Type	Ring Tongue
Barrel Type	Closed
Terminal Orientation	Straight
Terminal Plating Material	Tin



### Mechanical Attachment

Wire Insulation Support	Without
-------------------------	---------

### Dimensions

Wire Size	2050 – 5180 CMA
Stud Diameter	10.5 mm[.413 in]
Tongue Thickness	.79 mm[.031 in]
Overall Product Length	32.46 mm[1.278 in]
Accepts Wire Insulation Diameter (Max)	4.9 mm[.193 in]
Accepts Wire Insulation Diameter Range	3 – 4.9 mm[.118 – .193 in]

### Usage Conditions

Insulation Option	Partially Insulated
Operating Temperature Range	105 °C[221 °F]

### Operation/Application

Compatible With Wire Base Material	Copper
Compatible With Wire Plating Material	Tin
Heavy Duty	No

### Industry Standards

Government Qualified	No
----------------------	----

### Packaging Features

Packaging Quantity	50
Packaging Method	Small Pack

### Product Compliance

[For compliance documentation, visit the product page on TE.com>](#)

EU RoHS Directive 2011/65/EU	Compliant
EU ELV Directive 2000/53/EC	Compliant
China RoHS 2 Directive MIIT Order No 32, 2016	No Restricted Materials Above Threshold
EU REACH Regulation (EC) No. 1907/2006	Current ECHA Candidate List: JUNE 2022 (224) Candidate List Declared Against: JUNE 2022 (224) Does not contain REACH SVHC
Halogen Content	Not Low Halogen - contains Br or Cl > 900 ppm.

Solder Process Capability

Not applicable for solder process capability

Product Compliance Disclaimer

This information is provided based on reasonable inquiry of our suppliers and represents our current actual knowledge based on the information they provided. This information is subject to change. The part numbers that TE has identified as EU RoHS compliant have a maximum concentration of 0.1% by weight in homogenous materials for lead, hexavalent chromium, mercury, PBB, PBDE, DBP, BBP, DEHP, DIBP, and 0.01% for cadmium, or qualify for an exemption to these limits as defined in the Annexes of Directive 2011/65/EU (RoHS2). Finished electrical and electronic equipment products will be CE marked as required by Directive 2011/65/EU. Components may not be CE marked. Additionally, the part numbers that TE has identified as EU ELV compliant have a maximum concentration of 0.1% by weight in homogenous materials for lead, hexavalent chromium, and mercury, and 0.01% for cadmium, or qualify for an exemption to these limits as defined in the Annexes of Directive 2000/53/EC (ELV). Regarding the REACH Regulation, the information TE provides on SVHC in articles for this part number is based on the latest European Chemicals Agency (ECHA) 'Guidance on requirements for substances in articles' posted at this URL: <https://echa.europa.eu/guidance-documents/guidance-on-reach>

### Compatible Parts



### Also in the Series | PLASTI-GRIP

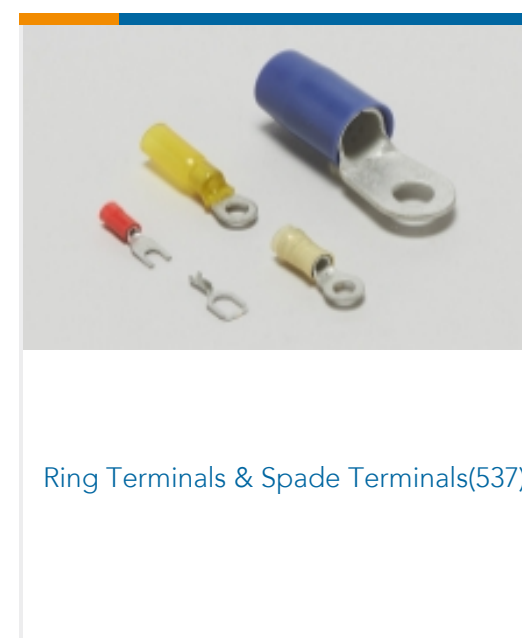
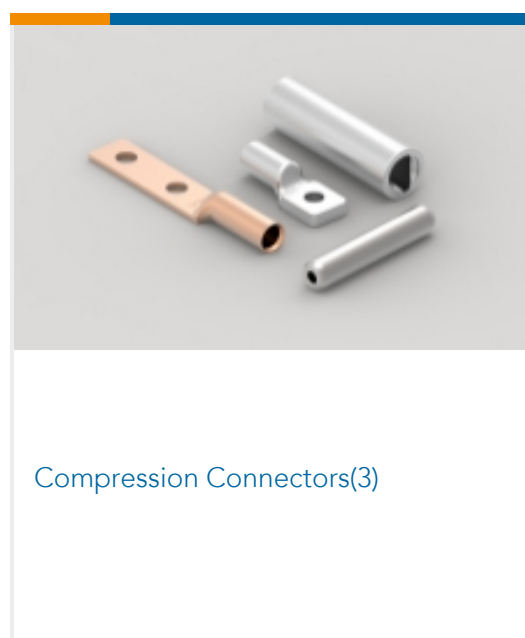

### Customers Also Bought

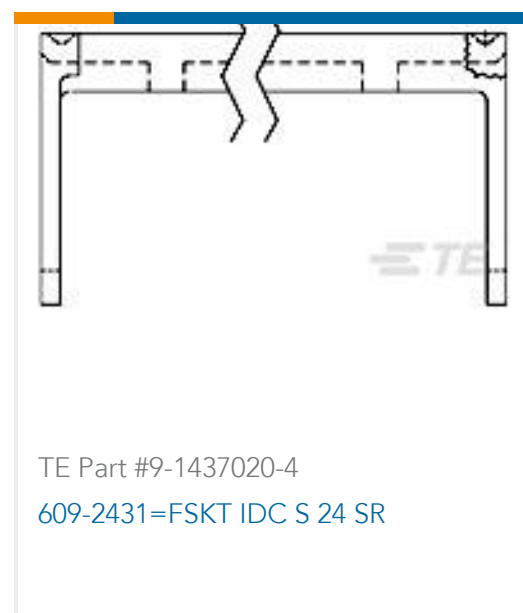



TE Part #826469-9  
2X9P MOD II SHROUDED HEADER, ST

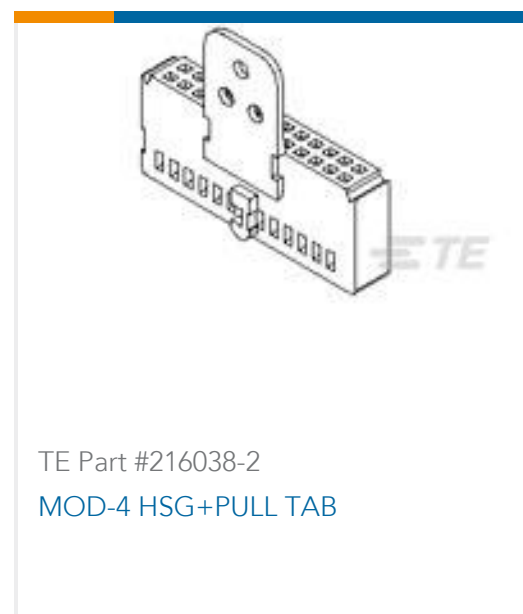

TE Part #216038-2  
MOD-4 HSG+PULL TAB

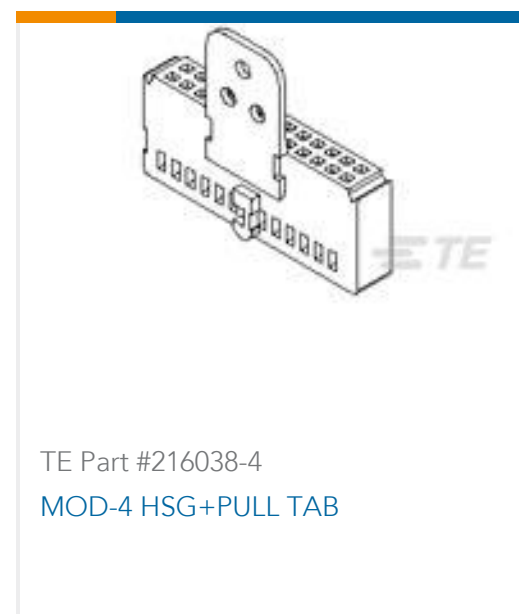

TE Part #216038-4  
MOD-4 HSG+PULL TAB



TE Part #282013-000  
44A0111-18-3



TE Part #5-927742-6  
6 POS FASTIN/ON HOUSING PANEL  
MOUNT

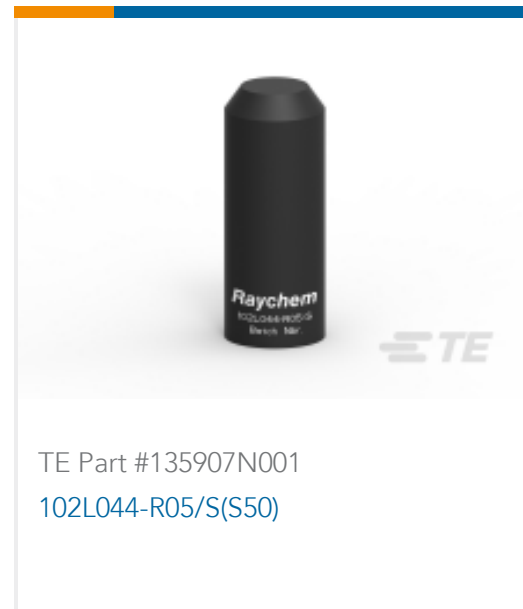

TE Part #135907N001  
102L044-R05/S(S50)

## Documents

### Product Drawings

[SMP 0-0160136-0](#)

English

### CAD Files

[3D PDF](#)

3D

Customer View Model

[ENG\\_CVM\\_CVM\\_5-1377175-6\\_G1.2d\\_dxf.zip](#)

English

Customer View Model

[ENG\\_CVM\\_CVM\\_5-1377175-6\\_G1.3d\\_igs.zip](#)

English

Customer View Model

[ENG\\_CVM\\_CVM\\_5-1377175-6\\_G1.3d\\_stp.zip](#)

English

By downloading the CAD file I accept and agree to the [Terms and Conditions](#) of use.

### Datasheets & Catalog Pages

[RADIATION\\_RESISTANT\\_PRE-INSULATED\\_TERMINALS\\_SPLICES](#)

English

### Product Specifications

[Application Specification](#)

English