

AGE 14+

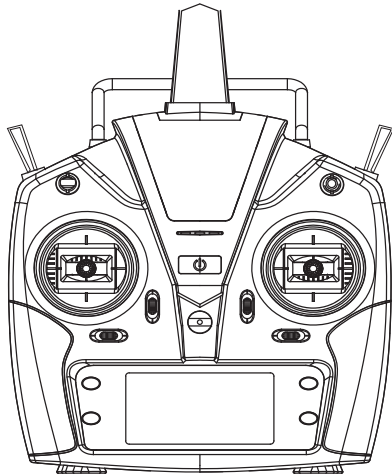

T6 INSTRUCTION MANUAL FOR REMOTE CONTROLLER

T6 INSTRUCTION MANUAL FOR REMOTE CONTROLLER

Attention

This remote controller supports various models such as fixed-wing aircrafts, helicopters and gliders, etc. and allows for parameter adjustment and multiple storage options with 1.4GHz technology adopted and in compliance with FUTABA communication protocol. So it's featured with remote control, interference-free and error correcting and easy to use. Here are the instructions in details.

Overview

* The remote control uses 4 AA batteries. It is strictly forbidden to use batteries and lithium batteries that do not conform to the product.
* The remote control is not a toy. It is not easy for children under 14 years of age to operate. If you are a beginner, please have an experienced pilot at your side. Manufacturers and distributors bear no responsibility for any damages caused by improper use of the products. Please read through this manual before you start to use it.

Remote Controller Tech Specs

Battery: 4 x 1.5V/DC AA battery (not included)
Working voltage: 6 - 9 V/DC
Working current: 100-150mA
Transmission frequency range: 2404 - 2447.5MHZ
Transmission power: 6.21dBm

Table of Contents

Remote Controller Tech Specs	1
Introducing Remote Controller	2
Introducing the Display	3
Standby Mode of Remote Controller	4
Mode Settings	4-9
Helicopter Setting Mode	10-15
Special Function Settings	15-16

Introducing Remote Controller

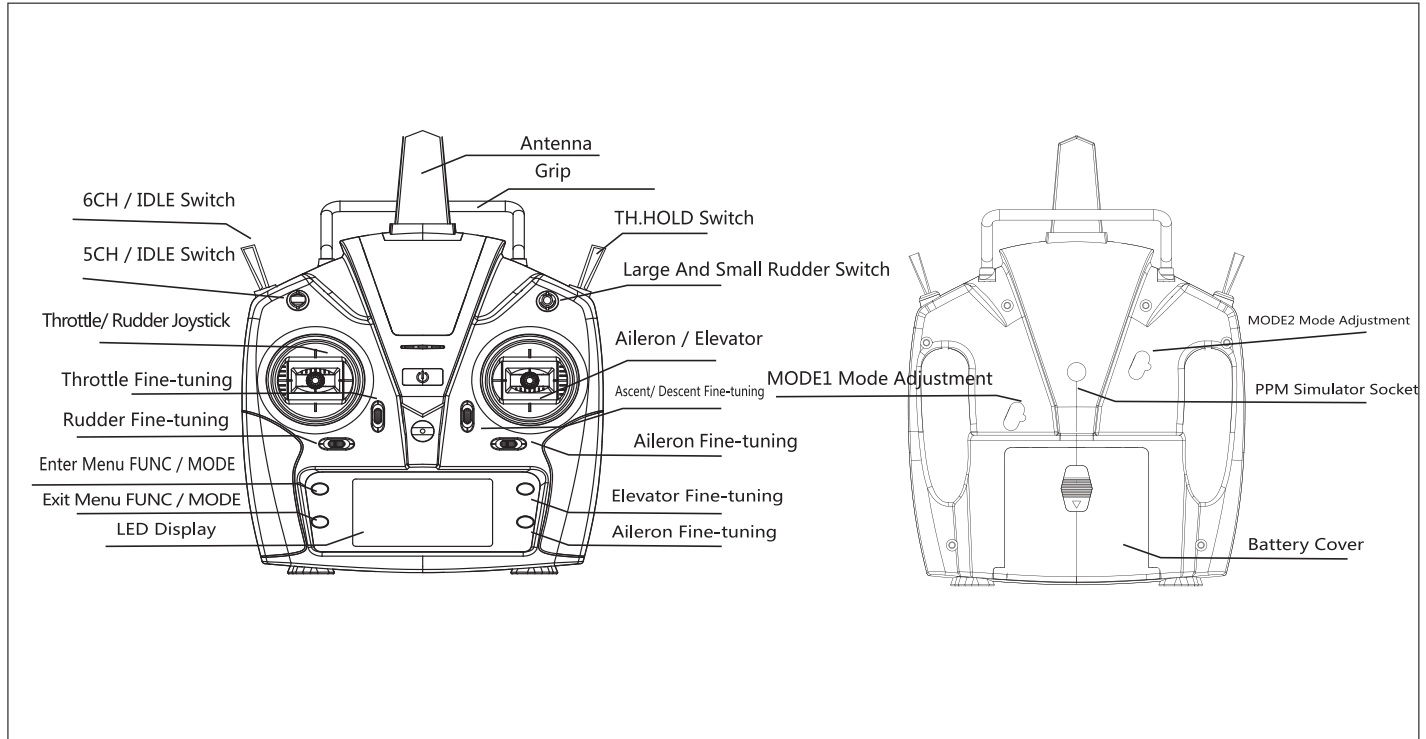

Introducing the Display

This remote control uses a bright, high-definition, segmented LED display as the user interface, and the following figure shows the full display interface

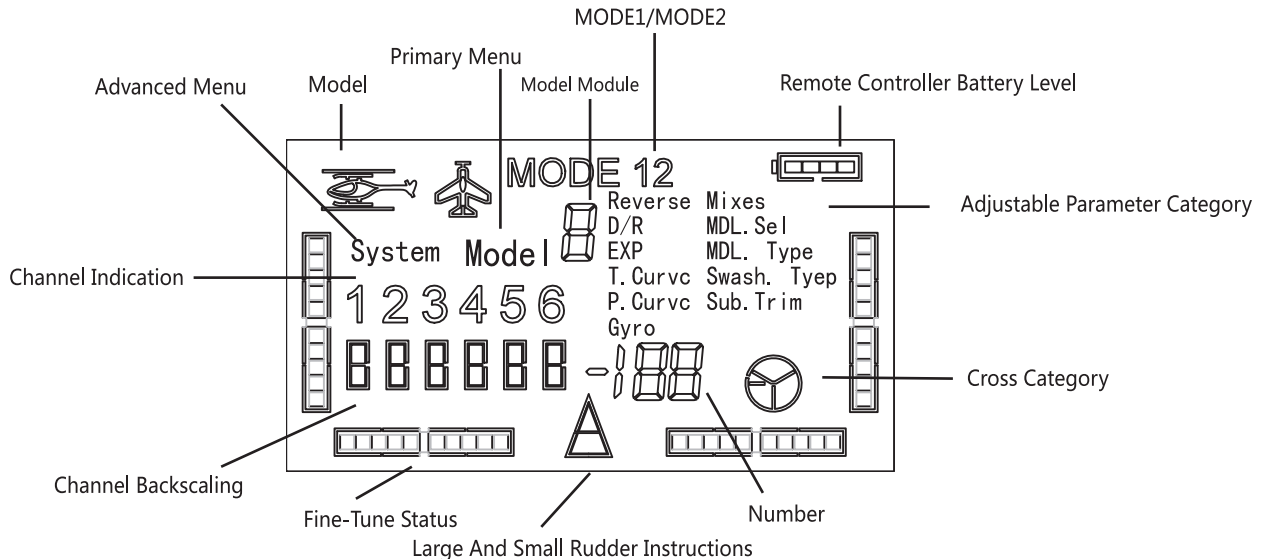

All of the parameters can be set through the above interface, which is easy to operate with hierarchies of:

- 1) Screen display at start-up: single line frame indicates the channels that are related to parameter settings.
- 2) Screen display for Helicopter Mode
- 3) Screen display for Fixed-wing Mode

Standby Mode of Remote Controller

Set the switches of the remote control to the normal positions (turn the switch towards where the remote controller's cover indicates), open the remote control to enter the standby state, and the LED displays the flight parameters and related information of the current mode, which can be categorized by fixed-wing mode settings, helicopter mode settings and special function.

Features	
Channel forward and reverse setting	Reverse
Big and small rudder settings	D/R
EXP curve setting	EXP
Throttle curve setting	T.Curvc
Mixes channel mixing settings	Mixes
Flight module settings	MDL.Sel
Model category setting	MDL.Type
Servo midpoint setting	Sub.Trim
Fixed-wing tuning parameters	
Channel forward and reverse setting	Reverse
Big and small rudder settings	D/R
EXP curve setting	EXP
Throttle curve setting	T.Curvc
Pitch curve setting	P.Curvc
Gyro gyroscope settings	Gyro
Flight module settings	MDL.Sel
Model category setting	MDL.Type
Swash plate category settings	Swash.Typep
Servo midpoint setting	Sub.Trim
Helicopter tuning parameters	

Special Function Settings
Remote control pairing
3D switch position protection
Throttle position protection
Remote control power management
Emulator function
Restore factory settings
MODE2 / MODE1 conversion
Calibrate the remote control joystick

Mode Settings

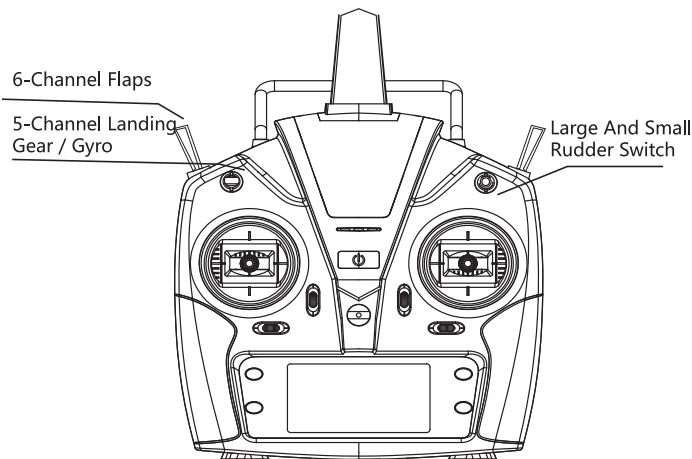

Switch Description

Channel Forward And Reverse Setting

Functions	How to Set Up	Description
<p>Set the directions of the moves based on the installation position of the server for purposeful operations.</p>	<ol style="list-style-type: none"> 1 Power-on status 2 Press the MODE button for one second, the beep sounds, the Reverse and 123456 flashes. 3 Press the MODE key again to select the channel to be adjusted, the corresponding channel number flashes, and Reverse and other channel numbers stop flashing. 4 Press the up or down button to reverse the icon, press the MODE button to confirm the setting and skip to the next channel, and press the END button to exit the setting. <div style="text-align: center; margin-top: 20px;">  </div>	<p>In forward and reverse setting, the transmitter output reflects the current setting status. You must press the confirmation key to save the setting result. It is recommended that the user set it without the propeller installed in the main motor to avoid injuries caused by sudden rotating of the propellers.</p>

Big And Small Rudder Settings

Functions	How to Set Up	Description
<p>Set the amount of rudders for the three channels of the aileron in the lifting direction, and set the required values for the up, down, left, and right of the joystick. This function is used to adapt to the stroke of the server or adjust the control feel.</p>	<ol style="list-style-type: none"> 1 Power-on status 2 Press the MODE button for one second, the beep sounds, the Reverse and 123456 flashes. 1 Power-on status 2 Press the MODE button for one second, the beep sounds, the Reverse and 123456 flashes. 3 Press the flip button continuously to scroll down, D / R and 12 4 flash. 4 Press MODE to enter the setting. The display channel 1 flashes. Use the joystick to select the channel to be set. The corresponding channel flashes. The other corresponding channel numbers stop flashing. 5 Use the up and down keys to increase or decrease the value. The corresponding channel joystick is used to select the assigned amount. 6 Press the MODE button to confirm and save, then press the END button twice to exit the current setting. 4 Press the up or down button to reverse the icon, press the MODE button to confirm the setting and skip to the next channel, and press the END button to exit the setting. 	<p>During forward and reverse setting, the transmitter output reflects the current setting status. You must press the confirmation key to save the setting result. It is recommended that the user set it without the propeller installed in the main motor to avoid injuries caused by sudden rotating of the propellers.</p>

E curve (EXP) Setting

Functions	How to Set Up	Description
<p>Provide users with joystick curve adjustment, improve operation feel, and provide positive and negative curve adjustment of the three channels of the aileron lifting direction.</p>	<ol style="list-style-type: none"> 1 Power-on status 2 Press the MODE button for one second, the beep sounds, the Reverse and 123456 flashes. 3 Press the flip button continuously to scroll down and EXP flashes. 4 Press MODE to enter the setting. Display 1 and the quantization digital module flash. Press the MODE button continuously to select the setting channel. 5 Increase or decrease the value by scrolling up or down. 6 Press the MODE key to save the setting and skip to the next channel setting. 7 After all settings are completed, press the MODE key to save the data, and then press the END key twice to exit the current setting. 	<p>The joystick curve index is positive, which means that the middle of the joystick changes quickly and the two ends change slowly. When it is negative, the middle change is slow and the two ends change quickly. The curve index setting value is $-100\% \rightarrow +100\%$.</p>

The following figure describes the effect of the curve index on the manipulated output

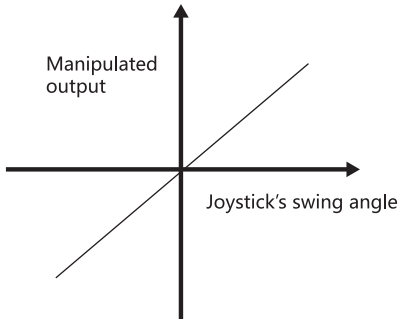

■ Joystick index curve value is 0

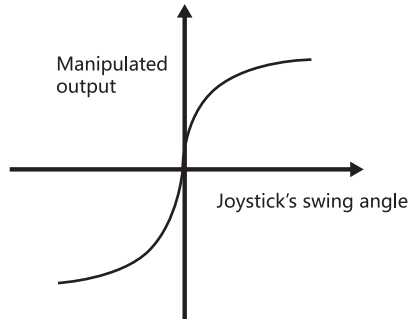

■ The value of the joystick index curve is 60

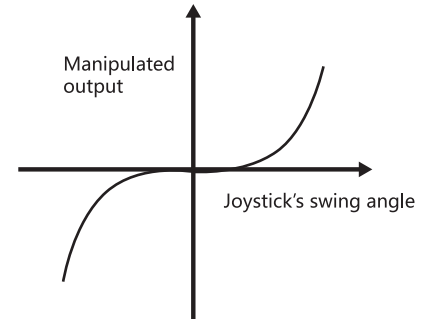

■ Joystick index curve value is -60

Throttle Curve Setting

Functions	How to Set Up	Description
<p>Provide users with linear adjustment settings of the throttle joystick to improve the feel.</p>	<ol style="list-style-type: none"> 1 Power-on status 2 Press the MODE button for one second, the beep sounds, the Reverse and 123456 flashes. 3 Press the scroll button continuously to scroll down, T.Curc and 12345 flash on the display. 4 Press the MODE key to enter 1 and the digital module flashes, and 2345 stops flashing. 5 Use the up / down keys to set the current value, up to increase the value, and down to decrease the value. 6 Press the OK key to save the data and skip to the next position. 7 After setting, press the MODE button to confirm and press the END button twice to exit the setting. 	<p>The throttle curve 1 2 3 4 5 represents the five positions of the throttle stroke. The default value is 0 25% 50% 75% 100%. The maximum output is set to 100%, and the minimum is 0 output. 1 and 5 represent the minimum and maximum of the throttle setting. Please set the throttle stroke according to your own needs.</p>

The following figure describes the effect of the throttle curve index on the output

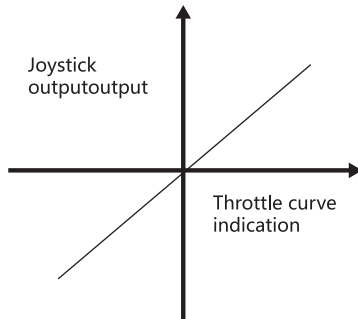

Default throttle curve indication

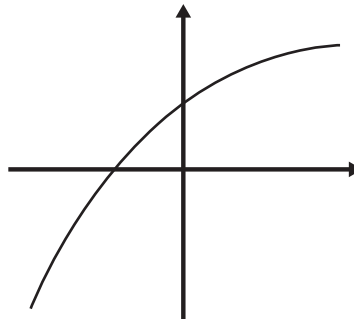

Throttle curve indication
1/0 2/40% 3/70% 4/80% 5/100%

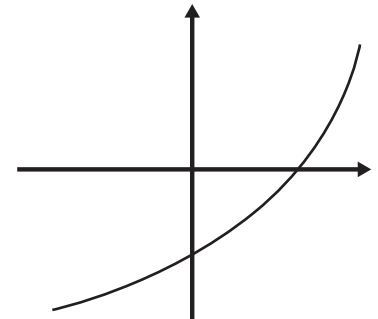

Throttle curve indication
1/0% 2/15% 3/35% 4/60% 5/100%

Channel Mixing Settings

Functions	How to Set Up	Description
Provide users with three mixing modes commonly used in fixed-wing.	<ol style="list-style-type: none"> 1 Power-on status 2 Press the MODE button for one second, the beep sounds, the Reverse and 123456 flashes. 3 Press the flip button continuously to scroll down. Mixes and 1246 flash. 4 Press the flip key to enter the mixing control mode and select 1 6-channel mixing control 2 4-channel mixing control and 12-channel mixing control. 5 After selecting the channels to be mixed, press the OK key to enter. The current channel and quantization module flash, the preset amount is 100%. 6 After setting the current channel, press the MODE button to confirm and skip to the secondary channel setting. 7 After the secondary channel is set, press the MODE button to confirm, and press the END button twice to exit. 	<ol style="list-style-type: none"> 1. After the setting is completed, the channel display area will be displayed. Shows the current mixing control status. 2. 1 and 2 are for delta wing, 2 and 4 for V-shape tail, and 1 and 6 for flaperon. 3. Data setting value -100%--+ 100%, negative value, which means that the action direction is opposite to the joystick direction.

Mixed Control Mode	Channel Display	Suitable For
1	1 Aileron Channel	Delta wing
	2 Lifting Channel	
2	3 Lifting Channel	V-shape tail
	4 Direction Channel	
3	5 Aileron Channel	Flap aileron
	6 Flap Channel	

Cancel Mixed Control Mode

- 1 Power-on status
- 2 Press the MODE button for one second, the beep sounds, the Reverse and 123456 flashes.
- 3 Press the flip button continuously to scroll down. Mixes and the current mixed control flash.
- 4 Press the Enter key to enter, and the Up key to scroll up to 1 2 4 6 flashes.
- 5 Press MODE to confirm and press END to exit. No mixed control channel is displayed on the display, and the mixed control mode is off.

Flight Module Settings

Functions	How to Set Up
By setting, users can set ten model parameters.	<ol style="list-style-type: none"> 1 Power-on status 2 Press the MODE button for one second, the beep sounds, the Reverse and 123456 flashes. 3 Press the flip button continuously to scroll down, MDL.Sel and Model0 flash. 4 Press the MOED button to confirm, MDL.Sel stops flashing, and the up button will move the setting module up. 5 After setting the module, press the MOED key to confirm the saved settings, and press the END key twice to exit the setting

Model Selection

Functions	How to Set Up
Easy for users to set different models	<ol style="list-style-type: none"> 1 Power-on status 2 Press the MODE button for one second, the beep sounds, the Reverse and 123456 flashes. 3 Press the scroll button continuously to scroll down, MDL.Type and 123456 flash. 4 Press the MOED key to confirm that MDL.Type stops flashing, the aircraft icon flashes, Up / Down button to switch helicopter or fixed wing icon 5 After setting the module, press the MOED key to confirm the saved settings, and press the END key to exit the setting

Servo Midpoint Setting

Functions	How to Set Up	Description
It is used to adjust the installation error of the servo rocker arm, which is convenient for users to debug, and does not affect the normal use of external trimming.	<ol style="list-style-type: none"> 1 Power-on status 2 Press the MODE button for one second, the beep sounds, the Reverse and 123456 flashes. 3 Press the flip button continuously to scroll down, Sub.Trim and the airplane pattern flash. 4 Press the MOED key to confirm that the Sub.Trim stops flashing and the channel 1 digital quantization module flashes. Press the MODE key continuously to select the channel to be set (1- 2 -4 -5 -6 cycles) 5 After selecting the channel to be set, use the up arrow key to increase the amount, and the down arrow key to decrease the amount. 	The setting values are -100- + 100%, and the maximum setting amount on both sides is equivalent to 10% of the joystick stroke. It must be bound to the aircraft when setting. The specific parameters are set according to the actual needs of the aircraft.

Helicopter Setting Mode

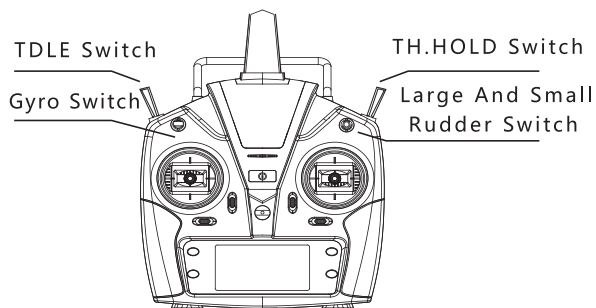

Switch Description

Channel Forward And Reverse Setting

Function Description	Setup Steps	Description
According to the installation position of the server, set the forward and reverse of the action to meet the operation needs	<ol style="list-style-type: none"> 1. Power-on status 2. Press the MODE button for one second. Reverse flashes with 123456 3. Press the MODE button again to select the channel to be adjusted. The corresponding channel number flashes, Reverse and other The channel numbers stop flashing. 4. Press the up or down key to reverse the icon, press MODE key to confirm the setting and skip to the next channel, Press the END key to exit the setting <p style="text-align: center;"> 1 2 3 4 5 6 1 2 3 4 5 6 ■■■■■■ — ■■■■■■ </p>	During forward and reverse setting, the transmitter output reflects the current setting status. You must press the confirmation key to save the setting result. It is recommended that the user set it without the propeller installed in the main motor to avoid injuries caused by sudden rotating of the propellers.

Big And Small Rudder Settings

Functions	How to Set Up	Description
Set the size of the rudders in the three channels of the aileron lifting direction, and set the required values for the up, down, left and right of the joystick. This function is used to adapt to the stroke of the server or adjust the control feel.	<ol style="list-style-type: none"> 1 Power-on status 2 Press the MODE button for one second, the beep sounds, the Reverse and 123456 flashes. 3 Press the flip button continuously to scroll down, D / R and 12 4 flash. 4 Press MODE to enter the setting. The display channel 1 flashes. Use the joystick to select the channel to be set. The corresponding channel flashes. The other corresponding channel numbers stop flashing. 5 Use the up and down keys to increase or decrease the value. The corresponding channel joystick is used to select the assigned amount. 6 Press the MODE button to confirm and save, then press the END button twice to exit the current setting. 	The position of the large and small rudder switches determines whether a large or small rudder amount is set. When selecting a channel, the displayed value is the current parameter. Use the joystick to select the channel to be set, and press MODE to confirm the direction selection. The setting range of the large and small rudder amounts is -125- + 125%. A negative value indicates that the direction of the joystick movement is opposite to the direction of swing.

E curve (EXP) Setting

Functions	How to Set Up	Description
<p>Provide users with joystick curve adjustment, improve operation feel, and provide positive and negative curve adjustment of the three channels of the aileron lifting direction.</p>	<ol style="list-style-type: none"> 1 Power-on status 2 Press the MODE button for one second, the beep sounds, the Reverse and 123456 flashes. 3 Press the flip button continuously to scroll down and EXP flashes. 4 Press MODE to enter the setting. Display 1 and the quantization digital module flash. Press the MODE button continuously to select the setting channel. 5 Increase or decrease the value by scrolling up or down. 6 Press the MODE key to save the setting and skip to the next channel setting. 7 After all settings are completed, press the MODE key to save the data, and then press the END key twice to exit the current setting. 	<p>The joystick curve index is positive, which means that the middle of the joystick changes quickly and the two ends change slowly. When it is negative, the middle change is slow and the two ends change quickly. The curve index setting value is -100%~+100%.</p>

The following figure describes the effect of the curve index on the manipulated output

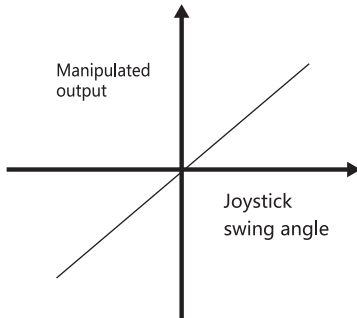

■ Joystick index curve value is 0

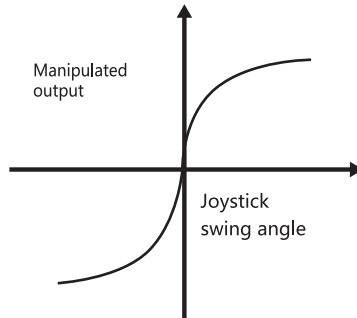

■ The value of the joystick index curve is 60

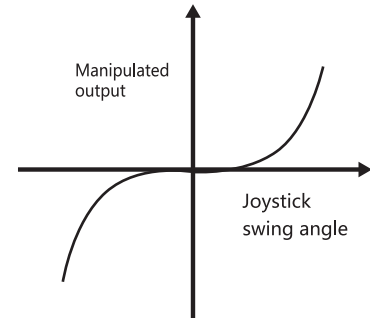

■ Joystick index curve value is -60

Throttle Curve Setting

Functions	How to Set Up	Description
<p>Provide users with linear adjustment settings of the throttle joystick to improve the feel. The throttle curve is adjusted in 5 points and divided into general throttle curve and 3D throttle curve</p>	<ol style="list-style-type: none"> 1 Power-on status 2 Press the MODE button for one second, the beep sounds, the Reverse and 123456 flashes. 3 Press the scroll button continuously to scroll down, T.Curc and 12345 flash on the display. 4 Press the MODE key to enter 1 and the digital module flashes, and 2345 stops flashing. 5 Use the up / down keys to set the current value, up to increase the value, and down to decrease the value. 6 Press the OK key to save the data and skip to the next position. 7 Turn on the 3D IDLE switch (toggle to the direction of the front cover), and set the 5 points of the 3D throttle curve as above. 8 After setting, press the MODE button to confirm and press the END button twice to exit the setting. 	<p>Throttle curve 1 2 3 4 5 represents the 5 positions of the throttle stroke. The default value of the general throttle curve is 0 25% 50% 75% 100%. Set the maximum output 100%. 3D IDLE switch is on. Set the 3D throttle curve. The default value is 85%. 85% 80% 85% 85%, please set the throttle stroke according to your needs.</p>

The figure below shows the effect of three kinds of curve indexes on the output of the default throttle curve, the set general throttle curve and the 3D throttle curve.

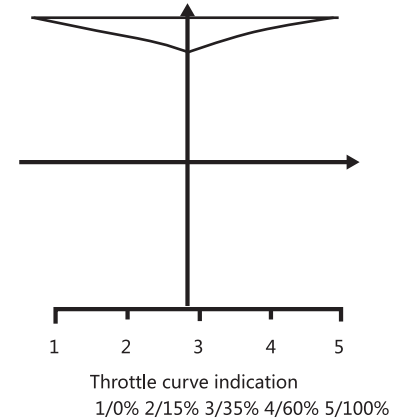
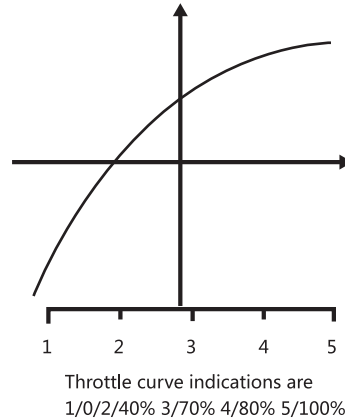
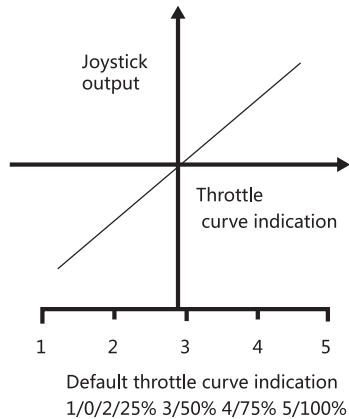

Pitch Curve Setting

Functions	How to Set Up	Description
<p>According to the requirements, the segment setting provides different pitch parameter settings. 5 points setting and general pitch and 3D pitch curve setting</p>	<ol style="list-style-type: none"> 1 Power-on status 2 Press the MODE button for one second, the beep sounds, the Reverse and 123456 flashes. 3 Press the scroll button continuously to scroll down, P.Curc and 12345 flash on the display. 4 Press the MODE key to enter 1 and the digital module flashes, and 2345 stops flashing. 5 Use the up / down keys to set the current value, up to increase the value, and down to decrease the value. 6 Press the OK key to save the data and skip to the next position. 7 Turn on the 3D IDLE switch (toggle to the direction of the front cover), and set the 5 points of the 3D pitch curve as above. 8 After setting, press the MODE button to confirm and press the END button twice to exit the setting. 	<p>In the curve setting, 1 2 3 4 5 points respectively correspond to the 5 positions of the throttle stroke. The default is 40% 45% 50% 60% 70%. The 3D IDLE switch is used to respectively general pitch curve and 3D pitch curve. When setting the curve, you must turn on the TH, HOLD switch or unplug the motor to prevent the blade from turning suddenly and causing injury.</p>

Gyroscope Sensitivity Setting

Functions	How to Set Up	Description
<p>Provide users with helicopter sensitivity settings, divided into locked sensitivity and unlocked sensitivity, gyroscope switch control distinction.</p>	<ol style="list-style-type: none"> 1 Power-on status 2 Press the MODE button for one second, the beep sounds, the Reverse and 123456 flashes. 3 Press the flip button continuously to scroll down, Gyro and quantization module flash. 4 Press MODE to enter the setting, Gyro stops flashing, the quantization digital module flashes, and the value can be increased or decreased by turning up or down. 5 After all settings are completed, press the MODE button to save the data, and then press the END button twice to exit the current setting. 	<p>Switch sensitivity setting. The default is 6G lock sensitivity on the switch. The default value is 75%. The default non-lock sensitivity on the switch is 25%.</p>

The sensitivity and tail-locked or non-tail-locked status are shown in the following figure:

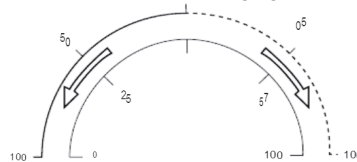

On the way, the thin solid line is the set value, and the thick dashed line and the thick solid line are the corresponding sensitivity values. The thick dotted line indicates the locked sensitivity. The thick solid line indicates the sensitivity of the fee lock mode.

Flight Module Setup

Functions	How to Set Up
By setting, the user can set up ten model parameters.	<ol style="list-style-type: none"> 1. Power-on status. 2. Press... 3. Consecutively press ... 4. Press... 5. Set...

Model Selection

Functions	How to Set Up
By setting, the user can set up ten model parameters.	<ol style="list-style-type: none"> 1 Power-on status 2 Press the MODE button for one second, the beep sounds, the Reverse and 123456 flashes. 3 Press the scroll button continuously to scroll down, MDLType and 123456 flash. 4 Press the MOED key to confirm that MDLType stops flashing, the aircraft icon flashes, and scroll up / down Flip key to switch helicopter or fixed wing icon 5 After setting the module, press the MOED key to confirm the saved settings, and press the END key to exit the setting

Midpoint Setting of Steering Gear

Functions	How to Set Up	Description
It is used to adjust the installation error of the servo rocker arm, which is convenient for users to debug, and does not affect the normal use of external trimming.	<ol style="list-style-type: none"> 1. Power-on status 2. Press the MODE button for one second, the beep sounds, the Reverse and 123456 flashes. 3. Continuously press the flip button to scroll down, Sub.Trim and the aircraft pattern flash. 4. Press the MOED key to confirm that the Sub.Trim stops flashing and the channel 1 digital quantization module flashes. Press the MODE key continuously to select the channel to be set (1- 2 -4 -5 -6 cycles) 5. After selecting the channel to be set, use the up arrow key to increase the amount and the down arrow key to decrease the amount. 6. After setting the module, press the MOED key to confirm the saved settings, and press the END key twice to exit the setting 	The setting values are -100- + 100%, and the maximum setting amount on both sides is equivalent to 10% of the joystick stroke. It must be bound to the aircraft when setting. The specific parameters are set according to the actual needs of the aircraft.

Swashplate Setting (Helicopter Only)

Functions	How to Set Up
Provide users with 2 different CCPM tilting disk mixing modes	<ol style="list-style-type: none"> 1 Power-on status 2 Press the MODE button for one second, the beep sounds, the Reverse and 123456 flashes. 3 Press the flip button continuously to scroll down, Swash.Type and flashing appear. 4 Press the MOED key to confirm that MDL.Type stops flashing, the swashplate icon flashes. 5 After setting the swashplate, press the MOED key to confirm the saved settings, and press the END key to exit the setting

Special Function Settings-Remote Control Pairing

Functions	How to Set Up
Used for communication between the remote control and the receiver. The code pair is required within 0.5 meters, and there is no FUTABA2.4GHZ S-FHSS communication protocol.	<ol style="list-style-type: none"> 1 Turn on the remote control, make sure the throttle stick is in the lowest position, and all switches are in the OFF position 2 Power on the receiver, the power indicator of the receiver is on 3 Touch the receiver's code button for 1 second, wait for the red light to go out, and enter the code 4 The red and blue lights are on when receiving, and the code pairing is successful.

3D Switch Position Protection

Functions	How to Set Up
Indication of improper user manipulation	When the remote control is turned on, the 3D switch is not in the OFF (pointing to the back cover) position, the remote control sends out beeping sound prompts, please slide the remote control switch to the correct position

Throttle Position Protection

Functions	How to Set Up
Indication of improper user manipulation	When the remote control is turned on, the 3D switch is not in the OFF (pointing to the back cover) position, the remote control sends out beeping sound prompts, please slide the remote control switch to the correct position

Emulator Function

Functions	How to Set Up	Description
Provide users with more ways to contact, output signals through the remote control PPM, practice flight on the simulator	<ol style="list-style-type: none"> 1. Turn on the remote control 2. Insert a 3.5mm dedicated audio cable into the PPM socket of the remote control, connect the dongle to the other end, and connect the dongle to the computer. 3. You can fly after opening the simulation software to set the parameters 	The Phoenix Emulator 4.0 or above must be installed on the computer. The remote controller connection simulator only provides the joystick output signal, and the remote controller needs to be turned on. Flight parameters need to be set in the simulator software

Remote Control Power Management

1. The remote control is in the power-on state, and it will be detected that the user does not operate the joystick within 5 minutes, and a power saving alarm will be performed.
2. The power of the remote control is simulated. When the remote control displays a drop alarm and the battery indicator box is blank, please replace the battery in time.

Reset

Functions	How to Set Up
This function can be used to quickly restore to factory settings when user settings are confused.	This function can be used to quickly restore to factory settings when user settings are confused.

MODE2 / MODE1 Conversion

Functions	How to Set Up	
Convenient for users to switch according to flight habits. Electronic adjustment and structural adjustment are required to exchange between Asian and American hands.	<ol style="list-style-type: none"> 1. Press and hold the MODE button to turn on the remote control. When the display is full and becomes MODE1 or MODE, release the MODE button. At this time, the remote control will issue a beep sound. You need to pull the corresponding throttle stick to the bottom to display. The screen returns to normal display, and the electronic conversion is OK. 2. Adjust the structure according to the following figure 	Structure adjustment requires a Phillips screwdriver. Only MOE1 and MODE2 flight modes can be switched.

Calibrate The Remote Control Joystick

Functions	How to Set Up
Improve the error of the remote control and improve the accuracy of the control. The rocker must be calibrated after the potentiometer is replaced for more accurate control.	<ol style="list-style-type: none"> 1. Rudder fine-tuning, right-click and turn on the remote control at the same time, the display is full and 123 beeps are released. Turn the trim button. 2. Hit the aileron, the lift stick, the throttle and the direction stick to the maximum and minimum, or draw a circle on the left and right sticks. Set the throttle stick to the middle position. 3 After completing the above actions, fine-tune the direction and dial to the right to exit the calibration. Click, pull the throttle stick to the lowest position, and the calibration is complete.

Structural Adjustment:

1. Use a Phillips screwdriver to loosen the current throttle rocker spring adjustment valve and damper adjustment to restore the elasticity of the current rocker.
2. Then lock the spring regulating valve on the other side, suppress the spring force, and lock the damping adjustment according to personal preference.

