

## Technical data:

Dimensions:	230 x 87 x 27mm
Weight:	615 g
Capacity:	66.6 Wh, 18.000 mAh (sum of the individual cells: 3 x 6,000 mAh)
Charging input:	14V DC voltage/1A
Power supply unit:	100-240V AC voltage, output: 14V/1A DC voltage („+“ inside)
Charging time:	approx. 8 hours to have a fully-charged battery
12V start up assistance power:	400A up to 10 seconds
Peak power for 12V:	600A approx. 1 second
Cooling time after jump-start attempt:	at least 30 seconds
Start-up attempts:	maximum of 3 times, then identify what is faulty on the vehicle (it is possible to perform a maximum of 20 jump-starts if the battery is fully charged)
Operating temp.:	-20°C up to +60°C
Storage temp.:	+10°C up to +60°C. The optimal temperature for storing the device lies between +15°C and +18°C. Never store the device in temperatures over +60°C and do not expose to direct sunlight.
Storage duration:	6-12 months with minor deterioration of the battery charge. Charge the device before storing it, as well as before starting to use it again after taking it out of storage. For the device to have a long service life, it should be charged every 3 months.
CE conformity:	This device meets the CE requirements. The Declaration of Conformity can be found on: dino-kraftpaket.de.

**R.D.I. Deutschland**  
Autoteile + Vertriebs GmbH  
Gahlenfeldstr. 36  
D-58313 Herdecke/Germany  
dino-kraftpaket.de

Stand 07.06.2018

## Causes of errors:

- **After turning the device on, the blue LED does not illuminate:** battery not charged, charge immediately using the 230V mains adapter
- **Device heats up when being used:** when operating at maximum performance, the Dino KRAFTPAKET 136240 will heat up. If 2 USB loads are connected, disconnect one. If you are using a laptop, remove the laptop's battery. In doing so, the laptop will only consume power purely for operational purposes without charging the laptop battery.
- **230V Mains adapter may also heat up during operation.** This is acceptable as long as the device only becomes warm to the touch, or slightly more. If the device starts to feel hot to the touch, remove the plug from the socket immediately and leave it to cool. Never use the mains adapter whilst a load is connected to the device as this can lead to overexertion. If the charger becomes hot to the touch despite these precautions having been taken, the device is faulty. It should be disconnected from the 230-volt mains and replaced.
- **It is not possible to charge the device via cigarette lighter:** Check the fuse in the charging cable plug (unscrew the top of the plug. Take out the fuse (type F2A, 5 x 20mm))

## Maintenance/servicing:

Firstly, disconnect the device from the charging cable or 230-volt power adapter. Wipe down with a damp cloth from time to time. Do not use any solvents or harsh detergents. When the cable is not connected, clean the terminal clip contact points with a brush and apply a little grease. Check the device and its accessories for damage before using. Do not use the device if it is faulty!

## Storage:

Store in a dry, well-ventilated place out of the reach of children. Always keep the cap on the start-up assistance jack closed (risk of short-circuits). If you are taking the device with you in the car, put it in the boot. When braking, make sure that the device does not break apart into dangerous debris.

The device should be stored at a temperature between +10° and +60°C. Charge device after 6 months in storage at the latest. For a long service life, we recommend charging the device every 3 months.

## Warnings:

- It is strictly necessary to read this instruction manual before starting to use the device. This should also be done if you have not used the device for a long period of time. Failing to observe this advice may cause serious injury to people and serious damage to objects!
- Only use the device and its accessories for their intended purpose.
- The warranty becomes void if the device and its accessories are not used in accordance with this manual. In particular, cables are burnt and lithium cells become ruined due to misuse.
- Please note the maximum operating time permitted for the start-up assistance!
- Only use the device if it is well ventilated. Sparks formation, as well as the gas which normally develops when lead-acid batteries are used, can cause explosions in closed spaces.

- Do not jump-start a vehicle in the presence of flammable substances, dust or other explosive environments.
- Do not submerge the device or its accessories in water; nor should you use them in a wet environment. Do not let liquids infiltrate the device or its accessories.
- Avoid dropping or bumping the device. Tools with damaged casing should not be entered into operation and must be disposed of in accordance to local regulations.
- Only use the device in areas where the temperature is between -20°C and +60°C. Never expose the device to higher temperatures (e.g. do not store the device on the rear shelf)

- Device does not contain any devices which can be repaired, nor does it contain fuses. Never open the device.

## General warnings:

- Store this manual in the same location as the device.
- The device should be operated with due care.
- The device should only be operated by adults. Minors should only use the device if instructed by, and under the supervision of, an adult.
- It is not a toy, keep away from children!
- Dispose of damaged devices or accessories at the end of their service life in accordance with local regulations.
- Not permitted for commercial use.
- Please note the safety information, as well as the maximum times permitted for putting strain on the device by jump-starting.

## Additional information concerning lithium batteries and power supply units:

- Do not open the device or lithium cells under any circumstances.
- Make sure that the battery does not come into contact with water.
- Do not store the device in temperatures higher than 60°C.
- Only charge the battery at an ambient temperature between 4°C and 40°C.
- Use only start-up assistance to discharge until the last bar is displayed on the charge status indicator. Further discharge can damage the lithium cells, even if this occurs just once. It is not possible to repair the elements in the device.
- Only use the charger provided with the device.
- Lithium batteries should only be disposed of in accordance to local regulations. This device has a WEEE registration number and is classed as electronic waste at waste deposit points. Do not dispose of the device in household waste!
- Lithium cells may leak in extreme circumstances. If you discover that fluid is leaking out of the device, wipe it away carefully using a cloth. Do not let the liquid come into contact with your eyes. The device, along with the lithium battery, should then be disposed thereof in accordance with regulations.

- Do not throw the lithium cells into a fire. This may cause an explosion!
- Please follow the advice below if the liquid comes into contact with your skin or eyes:  
**Warning: The battery fluid can cause bodily injury and material damage. Rinse the acid away using water if it has come into contact with your skin. If your skin becomes red, if a rash appears, or if you have any other symptoms of an irritation, please consult a doctor. If the liquid has come into contact with your eyes, rinse them straight away using clean water and seek medication attention immediately.**

- The charger is designed for voltages between 100 and 240 volts. Please make sure that the mains voltage corresponds to these values.
- Warning: do not replace the charger with a power cord. Only use the device with the components provided, as shown in this manual.
- Only use the charger in order to charge this device. Other batteries may explode and this can cause material damage or injury.
- Under no circumstances should you try to charge non-rechargeable batteries.
- If chargers have damaged cables or casing, please change immediately. Do not try to open the charger. It does not contain any service parts, such as fuses or similar.
- Do not modify the device.
- Make sure that the charger does not come into contact with water.
- The charger should not be operated in the open air.
- Please make sure that the battery has sufficient ventilation whilst it is being charged.
- The device may become warm to the touch when being used. If the device becomes hot to the touch, despite the information in the chapter entitled "Cause of errors", the device is faulty and should be replaced/disposed of.



**Dino**  
**KRAFTPAKET**

# 5 in 1 Jump Starter

## 600 - 12V

item no. 136240

## Operating Manual



**Before the first use, the device must be fully charged!**

Thank you for choosing Dino KRAFTPAKET (item no. 136240). Before entering the device into operation, please read this instruction manual carefully. This device provides additional power for 12 volt lead-acid batteries for vehicle engines and is suitable for operating electronic devices, without power sockets and outside vehicles.

### What's included and product description

This instruction manual, as well as the following components:

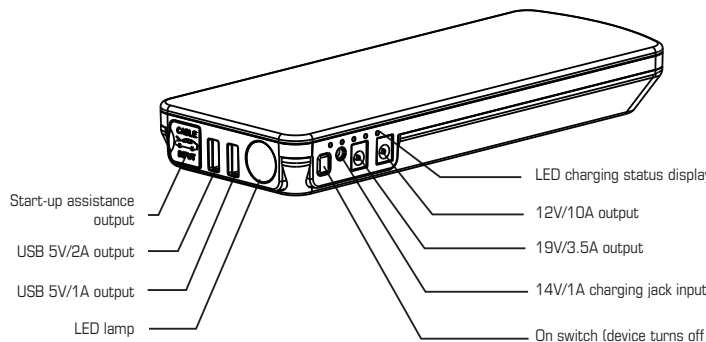

### 14V/1A charging jack input

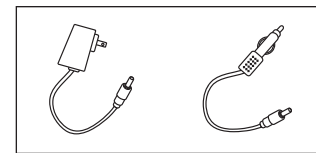

230-volt mains adapter/charger      12-volt adapter for the electrical system

### Start-up assistance output

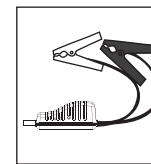

Start-up assistance cable with terminal clamps

### 19V 3.5A output

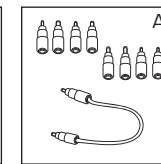

for laptops

### USB 5V 2A output

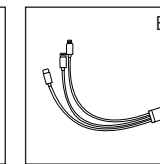

for smartphones & tablets

### 12V / 10A output

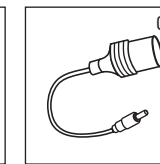

for 12-volt vehicle accessories

### LED charge status display

Briefly press the power button. Display turns on for 30 seconds:

LED bar display:	Off	Flashing 5x	1	2	3	4	5
Charging status:	0	10%	20%	40%	60%	80%	100%

During the charging process, one of the bars will flash to show the charging status, as above.

All bars disappear if the charging process is interrupted, or if the lithium battery has been fully charged.

If no bars are displayed, charge the device immediately. Do not store or use when discharged.

### Charging process

1) Insert the 230V mains adapter into the power socket, then connect to the 14V / 1A charging jack. It takes approx. 8 hours to have a fully-charged battery

Or

2) Insert the 12V electrical system adapter plug into the cigarette lighter socket whilst the engine is running, then connect to the 14V / 1A charging jack.

**Charge only with the accessory provided!**

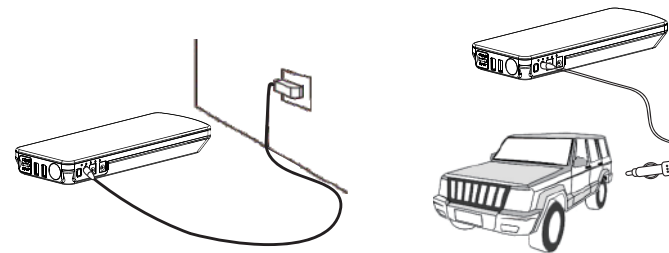

### Function: Start-up assistance

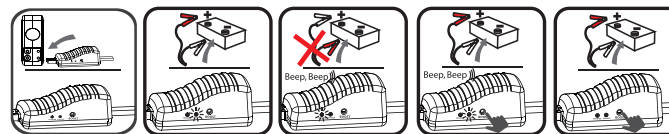

- Please take care when performing work in the engine compartment. Cooling fans may turn on automatically even if the ignition is turned off.
- Please make sure that the device cannot tip over. Make sure moving parts cannot be touched.
- Briefly press the power button. Only provide start-up assistance if 4 bars are displayed. Otherwise, please charge the device before use.
- **The start-up process should last a maximum of 10 seconds, then leave the device to cool for 30 seconds. Please observe these time periods! Otherwise, the device and its components will get damaged. Faults caused by misuse are not covered by the warranty.**
- If the engine does not start after three attempts, identify the cause of the error on the vehicle and remedy. Disconnect the device before performing any further jump-start attempts.

- 1) Connect the start-up assistance cable with the blue plug to the device. **Check that the device has been firmly connected and that the cable has been pushed all the way into the jack! Otherwise, the connectors will overheat!**
- 2) Red clamp with the + (plus) battery terminal
- 3) Black clamp with the - (minus) battery terminal

**It is crucial that terminal clamps are connected correctly. Terminals may need to be cleaned beforehand!**

- **green LED** illuminated on the start-up assistance cable: start the engine
- **red LED** illuminated and warning buzzer on: polarity has been reversed, swap the position of the device's red and black clamps on the battery.
- **flashing green LED** and warning buzzer on: battery is severely discharged, press the "BOOST" button on the start-up assistance cable and start the engine within 30 seconds. Please observe the maximum time of 10 seconds/30-second break, as if batteries have been severely discharged, this puts a huge strain on the device.
- **no display, no warning buzzer**: either the connection with the terminal clips is not tight enough, or the battery is completely empty. Press the "BOOST" button on the start-up assistance cable and start the engine within 30 seconds. Please observe the maximum time of 10 seconds/30-second break, as if batteries have been severely discharged, this puts a huge strain on the device.

4) After the engine has started, remove the start-up assistance cable immediately.

**Warning: the terminal clips should not be touching when the "BOOST" button is pressed. Heavy sparking, risk of explosion! Device will be destroyed!**

**Never use this device as a replacement starter battery in your vehicle. Do not try and start a vehicle which does not have a starter battery installed. Never disconnect the starter battery for the start-up assistance. Doing such things would destroy the alternator.**

### Function: USB connection

- Connect electrical loads (mobile phones, tablets, cameras etc.) with the USB 5V/2A output. Use the "B" adapter cable provided if necessary.
- Briefly press the power button.
- As long as current is flowing, the charging status display will remain functional. If the electrical load is charged, or if it has been disconnected from the device, the bar indication display will turn off.
- The Dino KRAFTPAKET 136240 turns off if it is overexerted, or if the electrical load has short-circuited. After the load has been disconnected, the device can be turned on again.

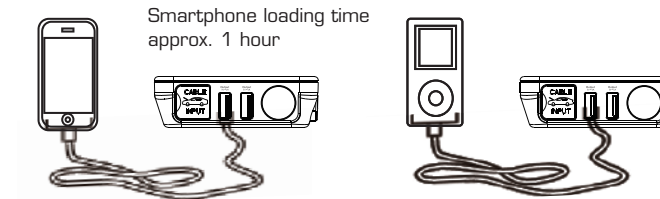

- If the discharging current is extremely low (lower than 0.5 watts), the device turns off (within 30 seconds), as a measure to protect against "gradual discharging".
- If the lithium battery in the Dino KRAFTPAKET 136240 is completely empty, the USB jack will turn off as a measure to protect the device from becoming deeply (and harmfully) discharged. The bar indication display will not come back on when the device is switched back on. Charge the device immediately afterwards. Do not put into storage if discharged.
- It is possible to use both USB ports at the same time. In doing so, the device will become warmer.

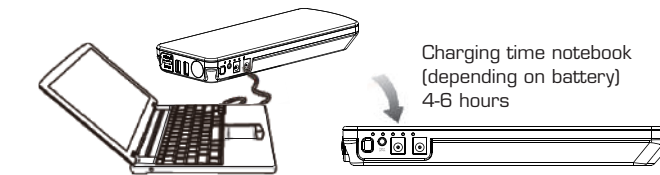

### Function: Charging a 19V notebook

- Connect the notebook with the cable and "A" adapter.
- Briefly press the power button.
- As long as current is flowing, the charging status display will remain functional.
- If the notebook is charged, or if it has been disconnected from the device, the bar indication display will turn off.
- In the event of overexertion, or if the notebook short-circuits, the Dino KRAFTPAKET 136240 turns off. In order to switch it back on, it is necessary to connect the device to the charging plug. As soon as

voltage flows into the charging jack, the LED lamp will flash quickly in order to signal that the rest has been confirmed.

- If the discharging current is extremely low, the device turns off (after 20 seconds), as a measure to protect against "gradual discharging".
- If the lithium battery in the Dino KRAFTPAKET 136240 is completely empty, the 19V/3.5A jack will turn off as a measure to protect the device from becoming deeply (and harmfully) discharged. The bar indication display will not come back on when the device is switched back on. Charge the device immediately afterwards. Do not put into storage if discharged.

### Function: Operating 12V/10A vehicle accessory

- Where necessary, connect the accessory with the cable and "C" adapter.
- Briefly press the power button.
- As long as current is flowing, the light on your cigarette lighter socket will illuminate.
- If the accessory is disconnected from the Dino KRAFTPAKET 136240, the light will turn off.
- In the event of overexertion, or if the accessory short-circuits, the Dino KRAFTPAKET 136240 will turn off. After the load has been disconnected, the device can be turned back on.
- If the discharging current is extremely low (lower than 5.5 watts), the device turns off.
- If the lithium battery in the Dino KRAFTPAKET 136240 is completely empty, the 12V/10A jack will turn off as a measure to protect the device from becoming deeply (and harmfully) discharged. The bar indication display will not come back on when the device is switched back on. Charge the device immediately afterwards. Do not put into storage if discharged!

### Function: LED lamp

- press the power button for 3 seconds: continuous light
- then press the button for just a moment: flashing
- then press the button for just a moment: SOS (3 x short, 3 x long in succession)
- then press the button for just a moment: Light turns off