

# Wirewound preset potentiometers

Series 115

Type 115 Q 7

Ordering code no.: 30 115 .....

Basic design: metal encased

**Special accessories: Plastic moulded spindles of different lengths and colours, suitable only with rotating arm 115 M**

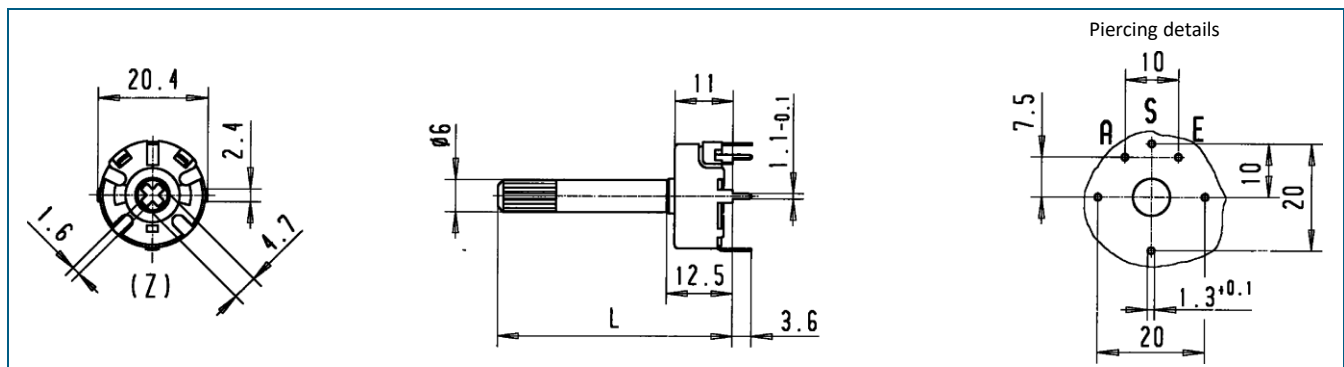
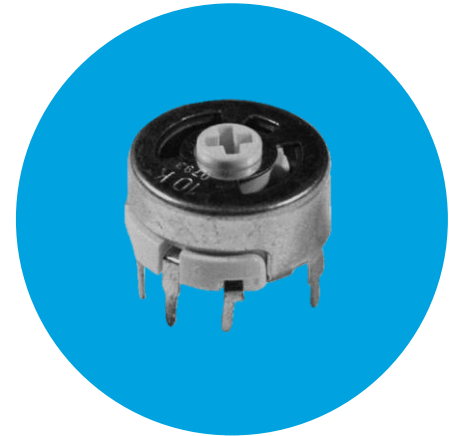

## Technical data

<b>Rated resistance range</b>	1 Ω - 22 kΩ	<b>Temperature coefficient</b>	See table
<b>Resistance tolerance</b>	± 10 % (< 10 Ω ± 20 %) on request ± 5 % (for values) > 47 Ω	<b>Resolution</b>	Depends on resistance value (≥ 1.5 %, max 0.16 %)
<b>Law (resistance taper)</b>	lin	<b>Electrical travel</b>	240° ± 15°
<b>Independent linearity</b>	± 2 % (on request ± 1 %)	<b>Mechanical travel</b>	270° ± 10°
<b>Rated dissipation</b>	2 W / 40 °C (also available with 3 W)	<b>Operating torque</b>	1 - 4 Ncm
<b>Isolation voltage</b>	750 V ~	<b>Endstop torque</b>	46 Ncm
<b>Temperature range</b>	-40 °C to +90 °C	<b>Durability</b>	500 cycles
<b>Tap</b>	„Z“ at 50 % of total resistance		

## Temperature coefficients

1 Ω - 22 Ω	22 Ω - 120 Ω	120 Ω - 3,3 kΩ	3,3 kΩ - 20 kΩ
+ 250 to 1 300 ppm / °C	+ 40 - 80 ppm / °C	+ 150 ppm / °C	± 10 ppm / °C