

# MS210-10\*

## DRAWN-SEAMLESS EMI/RFI SHIELD

### \*OPTIONAL SHIELD CONFIGURATIONS

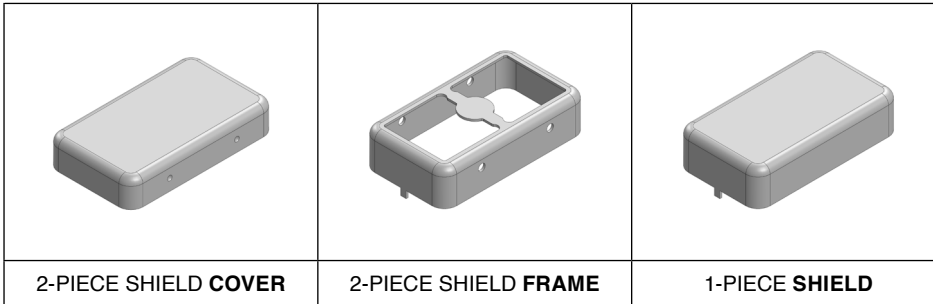

| ITEM P/N                     | ITEM DESCRIPTION                    | MATERIAL         |
|------------------------------|-------------------------------------|------------------|
| <a href="#">MS210-10C</a>    | 2-PIECE EMI/RFI SHIELD <b>COVER</b> | TIN-PLATED STEEL |
| <a href="#">MS210-10F</a>    | 2-PIECE EMI/RFI SHIELD <b>FRAME</b> | TIN-PLATED STEEL |
| <a href="#">MS210-10S</a>    | 1-PIECE EMI/RFI <b>SHIELD</b>       | TIN-PLATED STEEL |
| <a href="#">MS210-10C-NS</a> | 2-PIECE EMI/RFI SHIELD <b>COVER</b> | NICKEL-SILVER    |
| <a href="#">MS210-10F-NS</a> | 2-PIECE EMI/RFI SHIELD <b>FRAME</b> | NICKEL-SILVER    |
| <a href="#">MS210-10S-NS</a> | 1-PIECE EMI/RFI <b>SHIELD</b>       | NICKEL-SILVER    |

**TIN-PLATED STEEL:** CRS ELECTROLYTIC TINPLATE  
**NICKEL-SILVER:** UNS C77000 / UNS C73500



SHIELD CONFIGURATION:

MATERIAL:

© MASACH TECH LTD.  
 22 HAGANAN, MODIIN 7169513 ISRAEL  
 T: (+972) 8-9754681 / F: (+972) 8-9754682  
[info@masach.com](mailto:info@masach.com) / [www.masach.com](http://www.masach.com)

SHIELD TYPE:

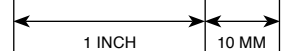

MMGS / PRINT 1:1 / A4

**MS210-10C**  
(Internal Dimensions)

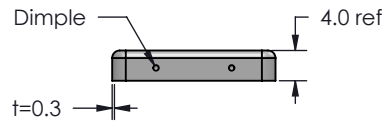
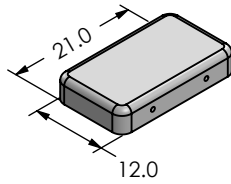

**MS210-10F**  
(External Dimensions)

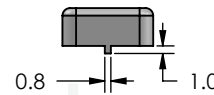
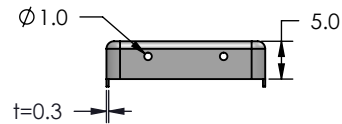
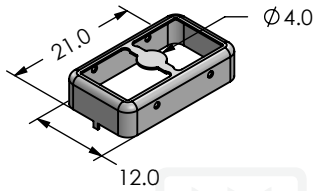

**FOOT-PRINT 1:1**  
(Symmetry)

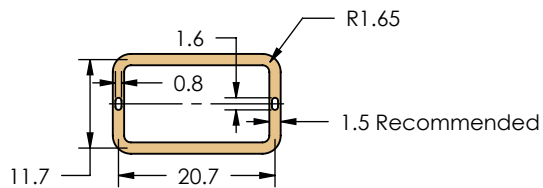

SHIELD CONFIGURATION:

**2-PIECE EM/RFI SHIELD**

MATERIAL:

**TIN-PLATED STEEL (1)**

**NOTE:** (1) CRS ELECTROLYTIC TINPLATE (2) GENERAL TOLERANCE (+/-) 0.2MM

© MASACH TECH LTD.  
22 HAGANAN, MODIIN 7169513 ISRAEL  
T: (+972) 8-9754681 / F: (+972) 8-9754682  
info@masach.com / www.masach.com

SHIELD TYPE:

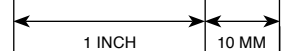

**DRAWN-SEAMLESS EM/RFI SHIELD**

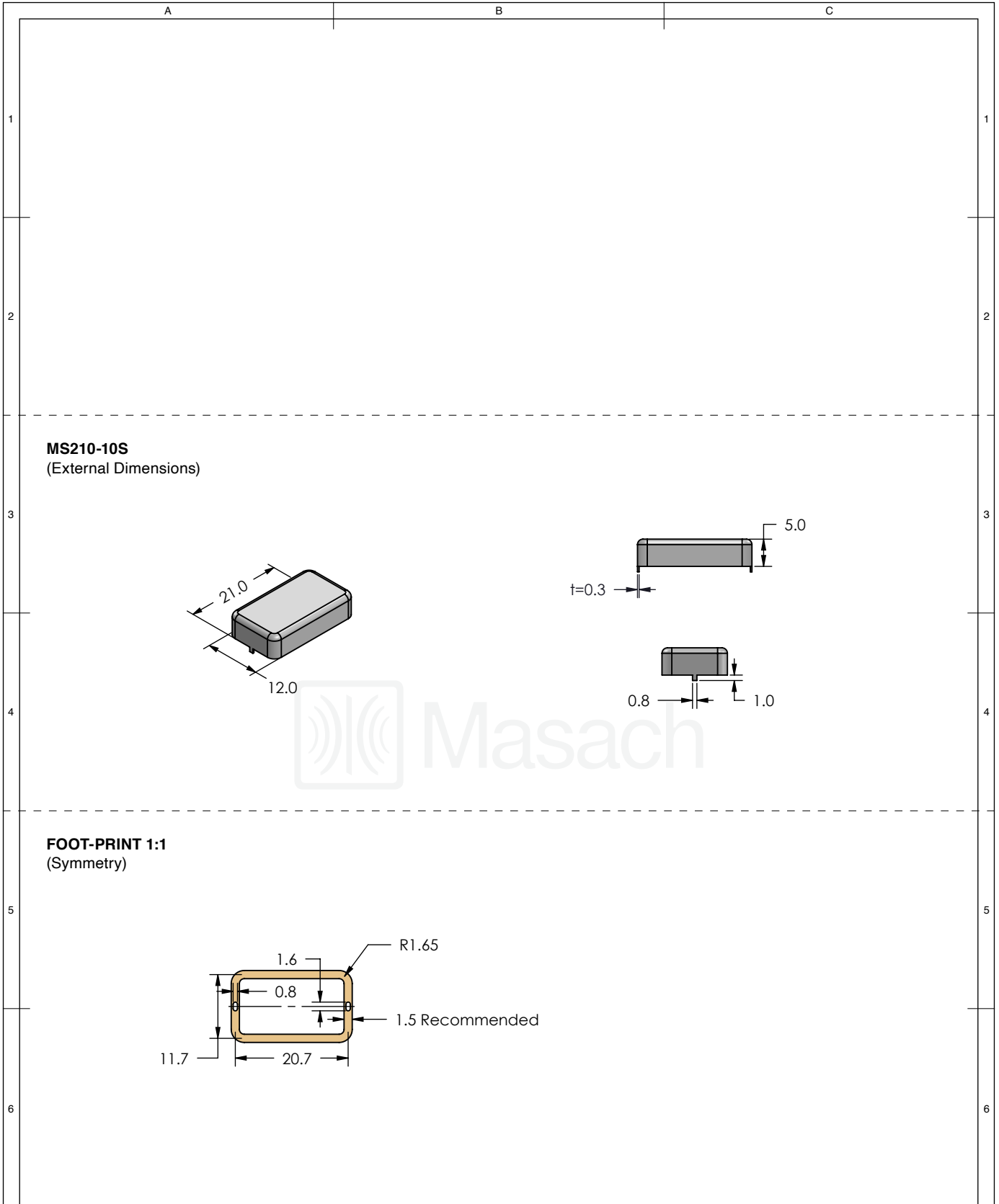

MMGS / PRINT 1:1 / A4

This product has been designed and manufactured by © Masach Tech Ltd. The use of this product in any type of electronic device or application is not under Masach Tech Ltd. liability.

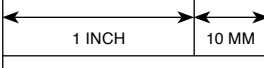

|   |                                     |   |
|---|-------------------------------------|---|
|    | SHIELD CONFIGURATION:               | MATERIAL:   |
|   | <b>1-PIECE EM/RFI SHIELD</b>        | <b>TIN-PLATED STEEL <sup>(1)</sup></b>  |
| <b>NOTE:</b> (1) CRS ELECTROLYTIC TINPLATE (2) GENERAL TOLERANCE (+/-) 0.2MM  |                                     |   |
| © MASACH TECH LTD.<br>22 HAGANAN, MODIIN 7169513 ISRAEL<br>T: (+972) 8-9754681 / F: (+972) 8-9754682<br><a href="mailto:info@masach.com">info@masach.com</a> / <a href="http://www.masach.com">www.masach.com</a> | SHIELD TYPE:                        |   |
|   | <b>DRAWN-SEAMLESS EM/RFI SHIELD</b> |    |
|   |                                     | MMGS / PRINT 1:1 / A4   |

This product has been designed and manufactured by © Masach Tech Ltd. The use of this product in any type of electronic device or application is not under Masach Tech Ltd. liability.

**MS210-10C-NS**  
(Internal Dimensions)

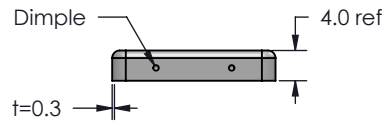
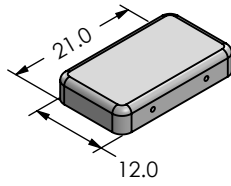

**MS210-10F-NS**  
(External Dimensions)

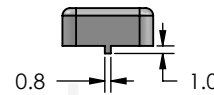
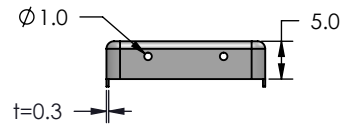
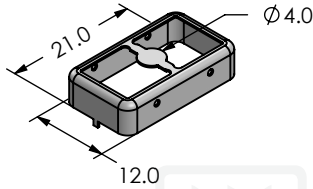

**FOOT-PRINT 1:1**  
(Symmetry)

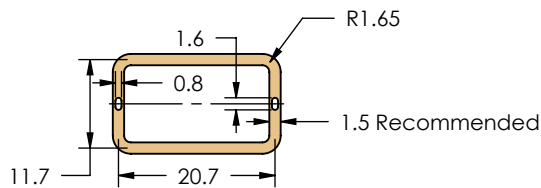

SHIELD CONFIGURATION:

**2-PIECE EM/RFI SHIELD**

MATERIAL:

**NICKEL-SILVER <sup>(1)</sup>**

**NOTE:** (1) UNS C77000 / UNS C73500 (2) GENERAL TOLERANCE (+/-) 0.2MM

© MASACH TECH LTD.  
22 HAGANAN, MODIIN 7169513 ISRAEL  
T: (+972) 8-9754681 / F: (+972) 8-9754682  
info@masach.com / www.masach.com

SHIELD TYPE:

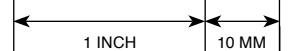

**DRAWN-SEAMLESS EM/RFI SHIELD**

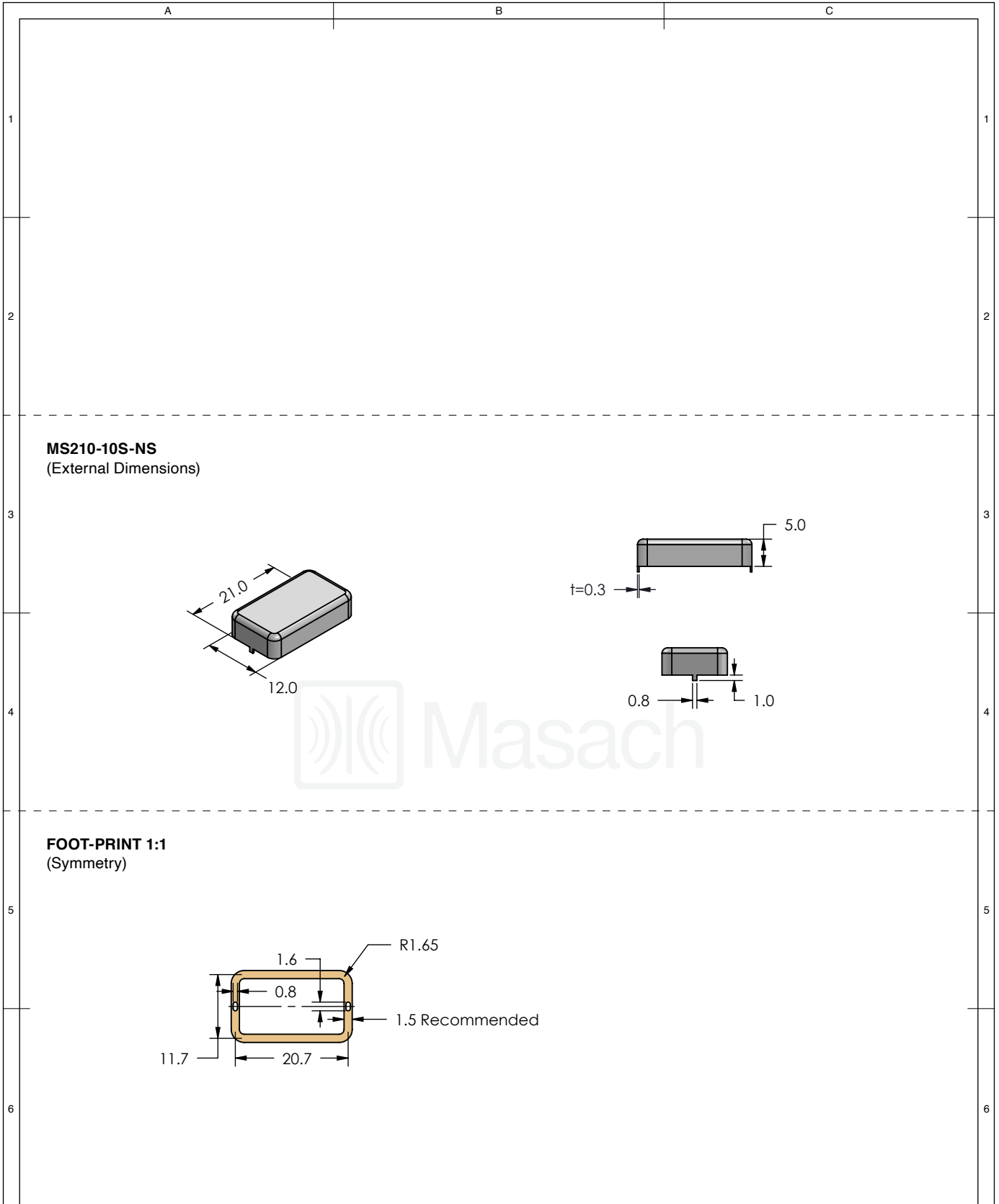

MMGS / PRINT 1:1 / A4

This product has been designed and manufactured by © Masach Tech Ltd. The use of this product in any type of electronic device or application is not under Masach Tech Ltd. liability.

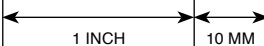

|   |  |  |   |   |
|---|--|--|---|---|
|    | SHIELD CONFIGURATION:  |  | MATERIAL:   |   |
|   | <b>1-PIECE EM/RFI SHIELD</b>   |  | <b>NICKEL-SILVER <sup>(1)</sup></b>   |   |
|   | <b>NOTE:</b> (1) UNS C77000 / UNS C73500 (2) GENERAL TOLERANCE (+/-) 0.2MM |  |   |   |
| © MASACH TECH LTD.<br>22 HAGANAN, MODIIN 7169513 ISRAEL<br>T: (+972) 8-9754681 / F: (+972) 8-9754682<br><a href="mailto:info@masach.com">info@masach.com</a> / <a href="http://www.masach.com">www.masach.com</a> | SHIELD TYPE:   |  |   |  |
|   | <b>DRAWN-SEAMLESS EM/RFI SHIELD</b>  |  |   |   |

This product has been designed and manufactured by © Masach Tech Ltd. The use of this product in any type of electronic device or application is not under Masach Tech Ltd. liability.

A

B

C

# MS210-10\* SMT/SMD PACKING TRAY

\* COMPATIBLE TO ALL SHIELD CONFIGURATIONS

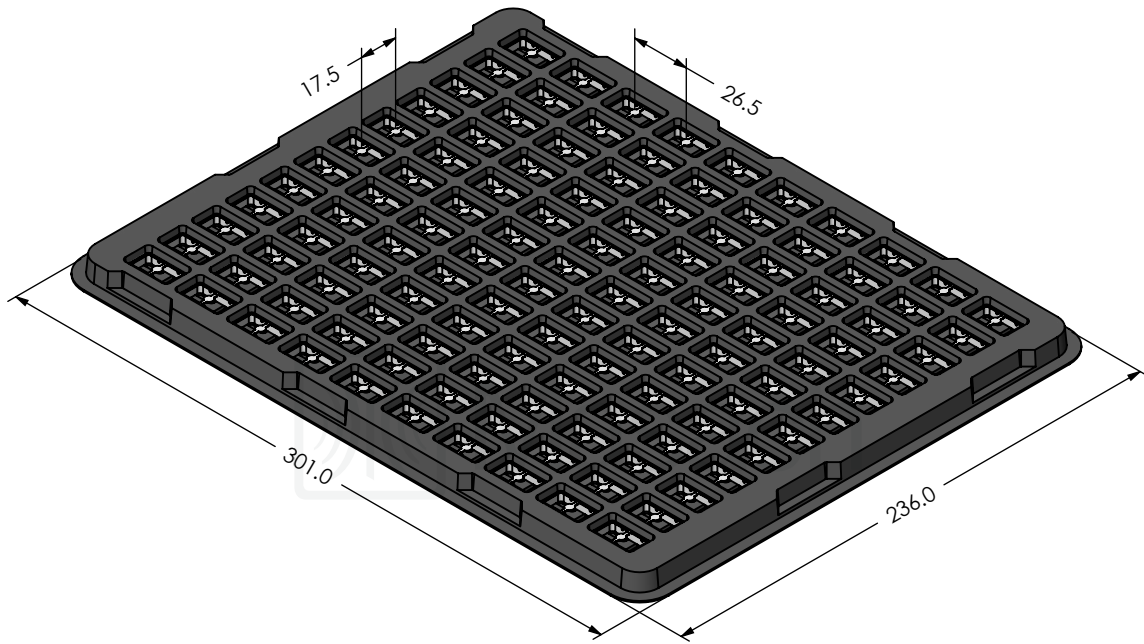

1

1

2

2

3

3

4

4

5

5

6

6



SHIELD CONFIGURATION:

MATERIAL:

© MASACH TECH LTD.  
 22 HAGANAN, MODIIN 7169513 ISRAEL  
 T: (+972) 8-9754681 / F: (+972) 8-9754682  
[info@masach.com](mailto:info@masach.com) / [www.masach.com](http://www.masach.com)

SHIELD TYPE:

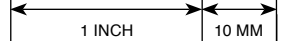

MMGS / PRINT 1:1 / A4

This product has been designed and manufactured by © Masach Tech Ltd. The use of this product in any type of electronic device or application is not under Masach Tech Ltd. liability.