

STRONG

VIDAA SMART TV 24" (60CM) SRT24HE4203



Bedienungsanleitung
Manuel d'utilisation
Manuale utente
Manual del usuario
Manual do utilizador
Használati útmutató
Užívateľský manuál

Brugervejledning
Brukerveiledning
Gebruiksaanwijzing
Användarhandbok
Korisnički priručnik
Ръководство на потребителя
Посібник користувача

SERVICE CENTER

AT	  support_at@strong.tv 0820 400 150 (€ 0,12/Min. österr. Festnetz)	HU	  support_hu@strong.tv +36 1 445 26 10
BG	  support_bg@strong.tv +359 32 634451	IT	  support_it@strong.tv 199 404 032 Da rete fissa 24,8 cent. al min. 12,5 cent. scatto alla risposta Da rete mobile max 49 cent. al min. 15,6 cent. scatto allo risposta
CZ	  support_cz@strong.tv 844 44 44 90	NL	  support_nl@strong.tv
DE	  support_de@strong.tv 0180 501 49 91 (€ 0,14/Min. deutsches Festnetz) (€ 0,42/Min. max. Mobilfunknetze)	PL	  support_pl@strong.tv 801 702 017
DK	  support_dk@strong.tv	PT	  support_pt@strong.tv +351 2 100 06 125
ES	  support_es@strong.tv +34 91 119 61 76	SK	  support_sk@strong.tv 0850 15 05 50
FR	  support_fr@strong.tv	SL	  +386 1 828 08 58
HR	  +385 1 344 57 66	UA	  support_ua@strong.tv +380 (44) 238 61 50

Supplied by STRONG Austria
Represented by STRONG Ges.m.b.H.
Teinfaltstraße 8/4.Stock
A-1010 Vienna, Austria
Email: support_at@strong.tv

Licenses

THIS PRODUCT IS LICENSED UNDER THE AVC PATENT PORTFOLIO LICENSE FOR THE PERSONAL AND NONCOMMERCIAL USE OF A CONSUMER TO (i) ENCODE VIDEO IN COMPLIANCE WITH THE AVC STANDARD ("AVC VIDEO") AND/OR (ii) DECODE AVC VIDEO THAT WAS ENCODED BY A CONSUMER ENGAGED IN A PERSONAL AND NON-COMMERCIAL ACTIVITY AND/OR WAS OBTAINED FROM A VIDEO PROVIDER LICENSED TO PROVIDE AVC VIDEO. NO LICENSE IS GRANTED OR SHALL BE IMPLIED FOR ANY OTHER USE. ADDITIONAL INFORMATION MAY BE OBTAINED FROM <MPEG LA, L.L.C.> SEE [HTTP://WWW.MPEGLA.COM](http://www.mpegla.com)

This product contains one or more programs protected under international and U.S. copyright laws as unpublished works. They are confidential and proprietary to <Dolby Laboratories>. Their reproduction or disclosure, in whole or in part, or the production of derivative works therefrom without the express permission of Dolby Laboratories is prohibited. Copyright 2003-2009 by Dolby Laboratories. All rights reserved.

THIS PRODUCT IS SOLD WITH A LIMITED LICENSE AND IS AUTHORIZED TO BE USED ONLY IN CONNECTION WITH HEVC CONTENT THAT MEETS EACH OF THE THREE FOLLOWING QUALIFICATIONS: (1) HEVC CONTENT ONLY FOR PERSONAL USE; (2) HEVC CONTENT THAT IS NOT OFFERED FOR SALE; AND (3) HEVC CONTENT THAT IS CREATED BY THE OWNER OF THE PRODUCT. THIS PRODUCT MAY NOT BE USED IN CONNECTION WITH HEVC ENCODED CONTENT CREATED BY A THIRD PARTY, WHICH THE USER HAS ORDERED OR PURCHASED FROM A THIRD PARTY, UNLESS THE USER IS SEPARATELY GRANTED RIGHTS TO USE THE PRODUCT WITH SUCH CONTENT BY A LICENSED SELLER OF THE CONTENT. YOUR USE OF THIS PRODUCT IN CONNECTION WITH HEVC ENCODED CONTENT IS DEEMED ACCEPTANCE OF THE LIMITED AUTHORITY TO USE AS NOTED ABOVE.

DISCLAIMER

Please be aware that STRONG, its manufacturing partners, the application providers and the providers of the services may collect and use technical data and related information, including but not limited to technical information about this device, system and application software and peripherals. STRONG, its manufacturing partners, the application providers and the providers of the services may use such information to improve its products or to provide services or technologies to you, as long as it is in a form that does not personally identify you.

Additionally, please keep in mind that some services provided - already in the device or installed by you - may request a registration for which you have to provide personal data.

Beside that, please be aware that some services which are not pre-installed but can be installed may collect personal data even without providing additional warnings and that STRONG cannot be held liable for a possible breach of data protection by services not pre-installed.

SIMPLIFIED EU DECLARATION OF CONFORMITY

Hereby, STRONG declares that the device SRT24HE4203 is in compliance with Directive 2014/53/EU.

The full text of the EU declaration of conformity is available at the following internet address: <https://www.strong.tv/en/doc>

Subject to alterations. In consequence of continuous research and development technical specifications, design and appearance of products may change. Manufactured under license from Dolby Laboratories. Dolby, Dolby Audio and the double-D symbol are trademarks of Dolby Laboratories. The terms HDMI, HDMI High-Definition Multimedia Interface, and the HDMI Logo are trademarks or registered trademarks of HDMI Licensing Administrator, Inc. Wi-Fi is a registered trademark of Wi-Fi Alliance®. Netflix is a registered trademark of Netflix, Inc. YouTube™ is a trademark of Google Inc. All product names are trademarks or registered trademarks of their respective owners.

© STRONG 2023. All rights reserved.

TABLE OF CONTENT

1. INSTRUCTION	2
1.1 Safety Instructions	2
1.2 Storage	3
1.3 Accessories	3
1.4 Equipment set-up	3
2. INSTALLATION	4
2.1 Default PIN code: 1234	4
2.2 Front panel	4
2.3 Rear panel	4
2.4 Remote control	5
2.5 Installing the batteries	6
2.6 Using the remote control	6
3. FIRST TIME INSTALLATION	7
3.1 Home	7
3.2 Input	7
4. PICTURE	8
4.1 Picture Mode	8
4.2 Aspect Ratio	8
4.3 Apply Picture Settings	9
5. SOUND	11
5.1 Sound Mode	11
5.2 Headphone	11
5.3 Sound Mode Settings	12
6. NETWORK	13
7. CHANNEL	14
8. SYSTEM	19
9. MEDIA	27
10. TROUBLESHOOTING	29
11. SPECIFICATIONS	30



1. INSTRUCTION

1.1 Safety Instructions

Read all of the instructions before operating the set. Keep these instructions well for later use.

- Only use attachments/accessories specified or provided by the manufacturer (such as the exclusive supply adapter, battery etc.).
- Please refer to the information on the exterior back enclosure for electrical and safety information before installing or operating the apparatus.
- To reduce the risk of fire or electric shock, do not expose this apparatus to rain or moisture.
- The ventilation should not be impeded by covering the ventilation openings with items, such as newspaper, table-cloths, curtains, etc.
- The apparatus shall not be exposed to dripping or splashing and no objects filled with liquids, such as vases, shall be placed on the apparatus.
- The mark ⚠ indicates a risk of electric shock. The external wires must be installed by an instructed person or ready-made leads or cords must be used.
- To prevent injury, this apparatus must be securely attached to the floor/wall in accordance with the installation instructions.
- Danger of explosion if the battery is incorrectly replaced. Replace only with the same or equivalent types.
- The battery (battery or batteries or battery pack) shall not be exposed to excessive heat such as sunshine, fire or the like.
- Excessive sound pressure from earphones and headphones can cause hearing loss.

Listening to music at high volume levels and for extended durations can damage one's hearing.

- In order to reduce the risk of damage to hearing, one should lower the volume to a safe, comfortable level, and reduce the amount of time listening at high levels.
- The mains plug or appliance coupler is used as disconnect device, it shall remain readily operable. When not in use and during movement, please take care of the power cord set, e.g. tie up the power cord set with cable tie or something like that. It shall be free from sharp edges or similar which can cause abrasion of the power cord set. When put into use again, please make sure the power cord is not damaged. In case of damages, please get the power cord replaced by a similar one with the same specifications. The absence of a light indication on the apparatus does not mean that it is fully disconnected from the mains. To disconnect the apparatus completely, the mains plug must be pulled out.
- Attention should be drawn to environmental aspects of battery disposal.
- No naked flame sources, such as lighted candles, should be placed on the apparatus.
-  To prevent the spread of fire, keep candles or other open flames away from this product at all times.
- A USB terminal can provide a maximum of 500 mA.
-  Equipment with this symbol is a Class II or double insulated electrical appliance. It has been designed in such a way that it does not require a safety connection to electrical earth.

Operating Environment

- Do not install this equipment in a confined space such as a bookcase or similar unit.
- Do not use the set near damp, and cold areas, protect the set from overheating.
- Keep away from direct sunlight.
- Do not use the set near dust place.
- Do not attach candle to accessible opening area, to avoid flammable foreign material from entering the TV.

WEEE Directive

 WEEE
Correct Disposal of this product. This marking indicates that this product should not be disposed with other household wastes throughout the EU. To prevent possible harm to the environment or human health from uncontrolled waste disposal, recycle it responsibly to promote the sustainable reuse of material resources. To return your used device, please use the return and collection systems or contact the retailer where the product was purchased. They can take this product for environment-safe recycling.

1.2 Storage

Your device has been carefully checked and packed before shipping. When unpacking it, make sure that all the parts are included and keep the packaging away from children. We recommend that you keep the carton during the warranty period, to keep your device perfectly protected in the event of repair or warranty.

1.3 Accessories

1x installation instructions
1x Safety Instructions/Warranty Cards
1x remote controls*
2x AAA batteries

1.4 Equipment set-up

Fig. 1

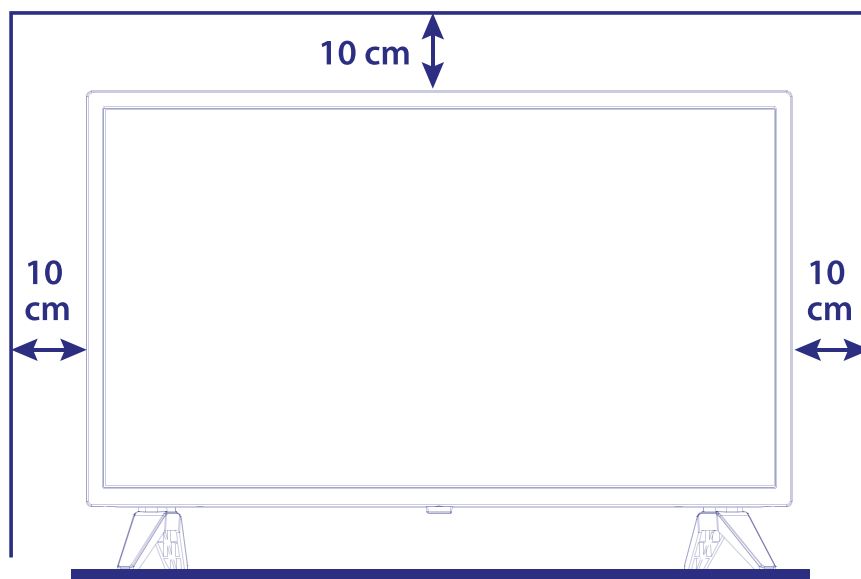

Install the display on a solid horizontal surface such as a table or desk. For ventilation, leave a space of at least 10 cm free all around the set. To prevent any fault and unsafe situations, please do not place any objects on top of the set. This apparatus can be used in tropical and/or moderate climates.

This user manual provides complete instructions for installing and using this TV. The symbols serve as follows:

- WARNING** Indicates warning information.
- NOTE** Indicates any other additional important or helpful information.
- MENU** Represents a button on the remote control or the TV.
- Move to* Represents a menu item within a window.

2. INSTALLATION



2.1 Default PIN code: 1234

2.2 Front panel

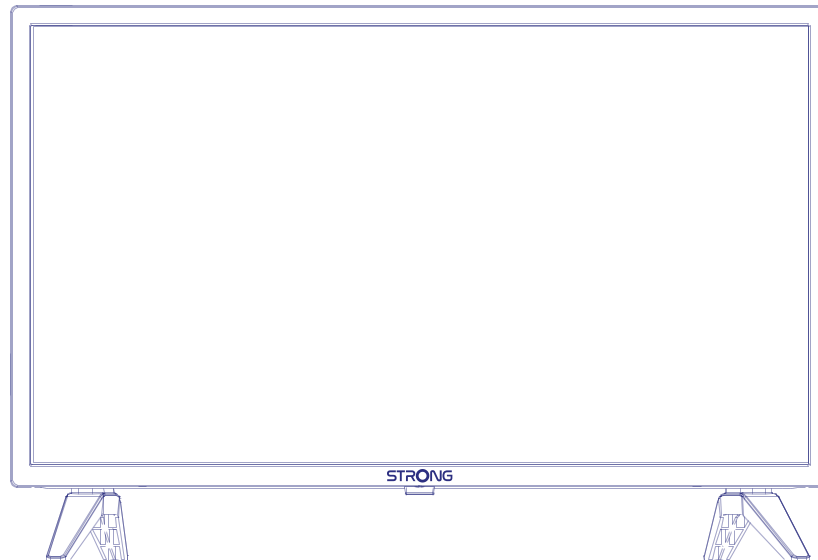
Fig. 2



NOTE: The graphics are for representation only.

1. Power indicator /remote sensor
2. Speakers
3.  /  Turns the TV on or in standby.

2.3 Rear panel

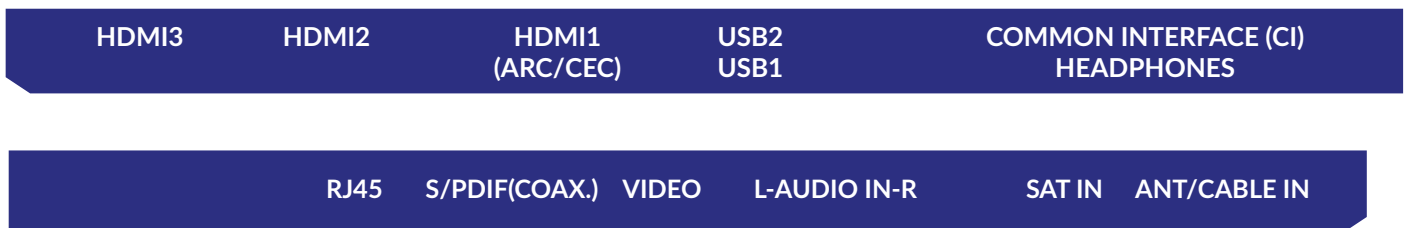

Fig. 3

1. HDMI 3 Connect HDMI input signal from a signal source such as DVD, Blu-ray player or game console.
2. HDMI 2 Connect HDMI input signal from a signal source such as DVD, Blu-ray player or game console.
3. HDMI 1 (ARC) Connect HDMI input signal from a signal source such as DVD, Blu-ray player or game console or directly to a Digital Amplifier that supports the ARC function. This input is equipped with the ARC (Audio Return Channel) feature to implement audio connections and for a full Dolby Audio support.
4. USB 2.0 USB 2.0 ports.
5. USB 2.0 USB 2.0 ports.
6. CI Insert a Conditional Access Module (CAM).
7. HEADPHONE Headphone or Earphone audio output, speakers will be muted when earphone is plugged in and headphone selected.
8. RJ45 Connect to your Internet router to access the internet/apps.

- 9. S/PDIF (optical) Use an optical cable to connect your TV to a compatible digital amplifier or Home theatre set.
- 10. AUDIO L/R Audio Left/Right IN. Use RCA Male (Plug) to RCA Male (Plug) to connect your TV at home theatre.
- 11. VIDEO Video IN. Use RCA Male (Plug) to RCA Male (Plug) to connect your TV with home theatre, s-video VCRs, camcorders or DVD players.
- 12. SAT IN Connect a coaxial cable to receive signal from the Dish LNB.
- 13. ANTENNA/
CABLE IN Connect a coaxial cable to receive signal from the DVB-T/T2 antenna or DVB-C cable.

NOTE: If the TV turns off when you plug a cable to any connector, just turn it on again.

2.4 Remote control

Fig. 4

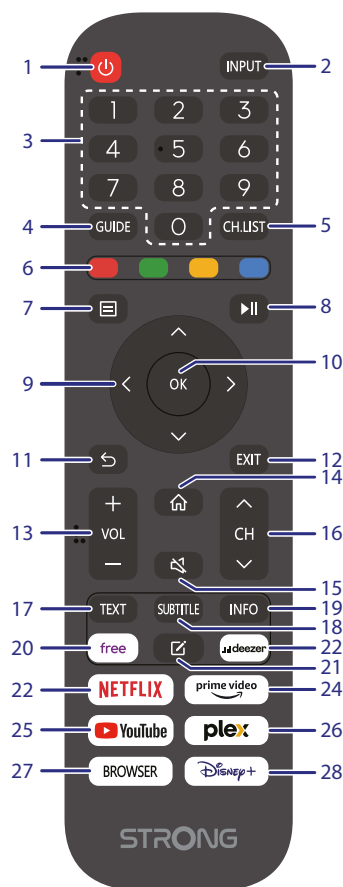

- 1. Press to turn the TV on or standby.
- 2. INPUT Press to select the different input signal sources
- 3. 0 ~ 9 Choose channel directly.
- 4. GUIDE Press to display the current GUIDE information in DTV mode.
- 5. CH. LIST Press to enter the channel list.
- 6. COLOUR BUTTONS Press to execute the prompt function in TV or DTV mode.
- 7. Open the menu options.
- 8. Press to pause playback, press again to continue playback.
- 9. Navigate the menu.
- 10. OK Confirm the selection.
- 11. Press to go back to previously viewed channel. In menu: Back to previous menu.
- 12. EXIT Exit the current menu.
- 13. VOL +/- Adjust the volume up or down.
- 14. Enter the home desktop.

- | | |
|---|--|
| 15.  | Press to mute or restore the volume. |
| 16. CH +/- | Change programmes up or down. |
| 17. TEXT | Press to enter or exit the teletext menu. |
| 18. SUBTITLE | Enable/disable subtitles in DTV mode. |
| 19. INFO | Display information about the current source. |
| 20. VIDAA free | Open free videos to watch from VIDAA server. |
| 21. Custom button | - Short press, short cut key to lance the selected application. - Long press, call the edit Launcher screen to select application. |
| 22. deezer | Press for direct access to deezer*. |
| 23. NETFLIX | Press for direct access to Netflix**. |
| 24. prime video | Press for direct access to prime video***. |
| 25. YouTube | Press for direct access to YouTube. |
| 26. plex | Press for direct access to plex****. |
| 27. BROWSER | Press for direct access to your Internet browser. |
| 28. Disney+ | Press for direct access to Disney+*****. |

* Membership is not included. Deezer is available in selected countries. Streaming deezer requires to set up an account. Broadband Internet required. See www.deezer.com for details.

** Membership is not included. Netflix is available in selected countries. Streaming Netflix requires to set up an account. Broadband Internet required. See www.netflix.com/TermsOfUse for details.

*** Membership is not included. Prime is available in selected countries. Streaming prime video requires to set up an account. Broadband Internet required. See www.primevideo.com for details.

**** Membership is not included. Plex is available in selected countries. Streaming plex requires to set up an account. Broadband Internet required. See www.plex.tv for details.

***** Membership is not included. Disney+ is available in selected countries. Streaming Disney+ requires to set up an account. Broadband Internet required. See www.disneyplus.com for details.

2.5 Installing the batteries

Fig. 5

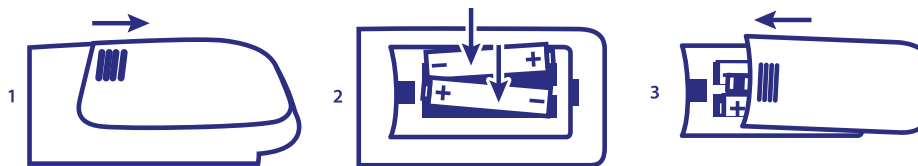

Place 2x AAA batteries in the battery compartment of the remote control. Make sure to match the polarity markings inside the compartment.

NOTE: Pictures are for reference only. Actual items may differ.

- 1 Open the cover.
- 2 Put 2x AAA batteries in the compartment and make sure the polarity is correct.
- 3 Close the cover.

Precautions for using the battery

Improper using of the battery will cause leakage. Carefully follow these instructions.

1. Please note the batteries' polarity to avoid short circuit.
2. When the battery's voltage is insufficient which affects the use range, you should replace it with a new battery. Remove the batteries from the remote-control unit if you do not intend to use it for a long time.
3. Do not use different types of batteries (for example Manganese and Alkaline batteries) together.
4. Do not put the battery into fire, and charge or decompose the battery.
5. Please dispose batteries abide by relevant environmental protection regulation.

2.6 Using the remote control

- Use the remote control by pointing it towards the remote sensor. Items between the remote control and the remote sensor could block normal operation.
- Do not cause the remote control to vibrate violently. Also, do not splash liquid on the remote control or put the remote control in a high humidity place.
- Do not place the remote control under direct sunlight which will cause deformation of the unit by heat.
- When the remote sensor is under direct sunlight or strong lighting, the remote control will not work. If so, please change the lighting or TV's position, or operate the remote control closer to the remote sensor.

* to confirm your choices use OK button or right ARROW button.

3. FIRST TIME INSTALLATION

After all connections have been made properly, switch your TV on. Please follow the initial installation procedure on your screen and complete the installation. It will take a few minutes.

3.1 Home

When you have finished the first-time setup, you can enter the  screen.

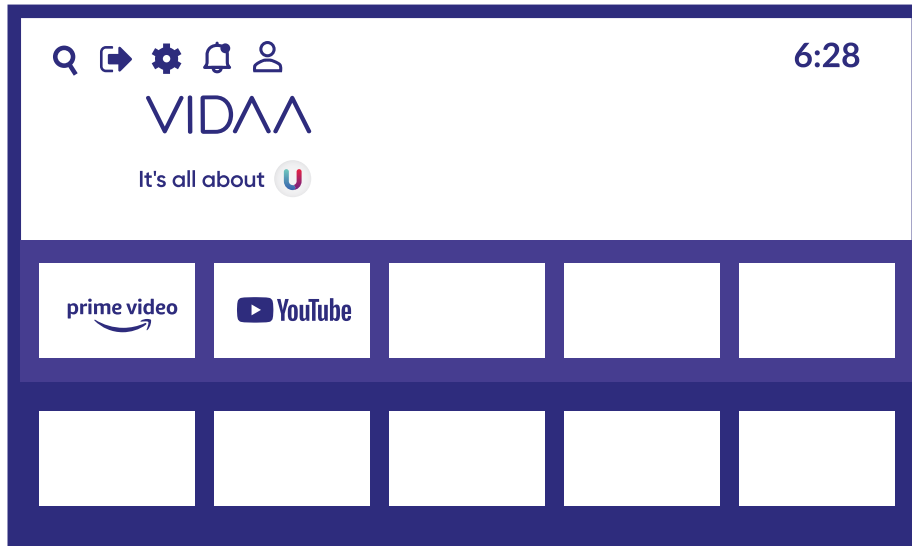

    Press the  button to select the  screen. On the remote control you can press     to select.

 **Inputs:** When you click on this icon you can select an input source.

 **Settings:** When you click on on this icon, various settings can be configured.

3.2 Input

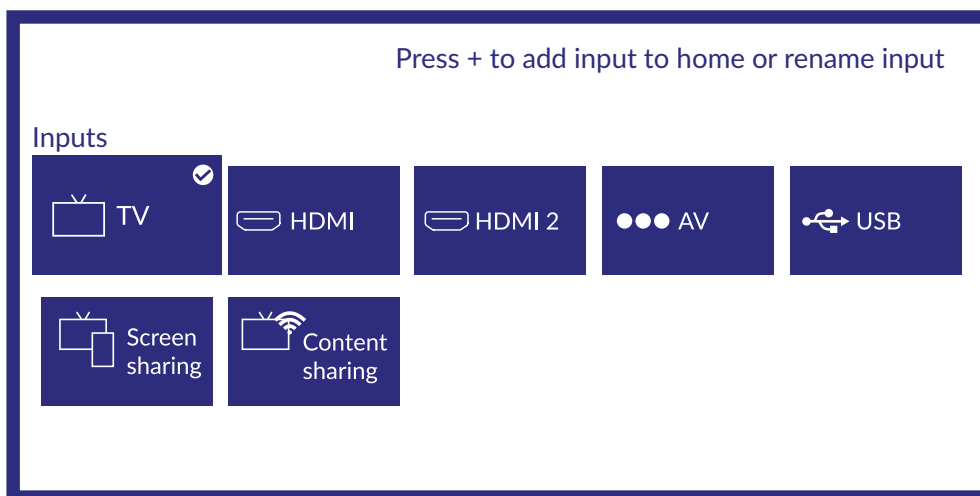

Press   to select the inputs menu and choose with     your choice. Press first OK to select the input.

Now press OK to enter the setting.

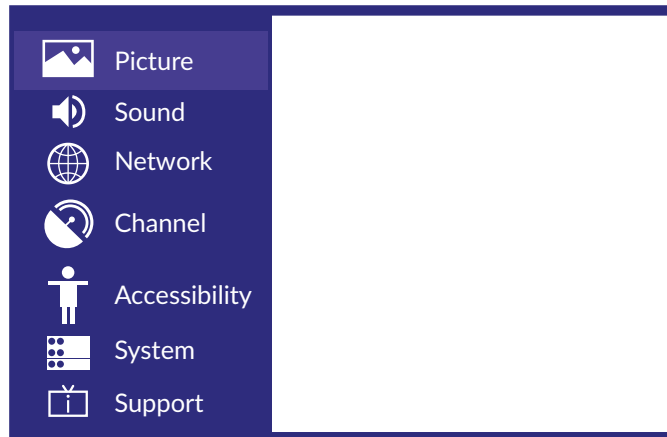

4. PICTURE

Press to enter the main menu press to select the picture menu.

1. Press to select the option that you want to adjust in the **PICTURE** menu.
2. Press OK to adjust.
3. After you have finished your adjustment, press OK to save the and return to the previous menu.

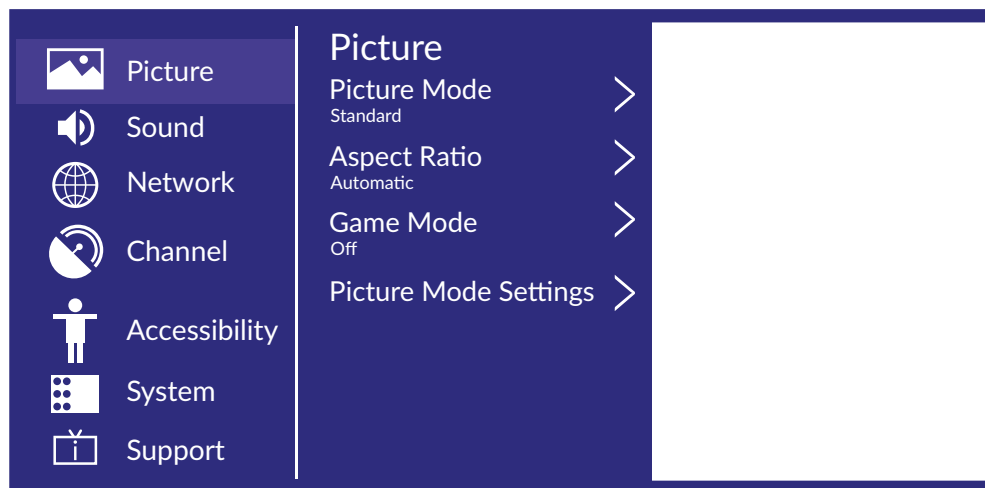

4.1 Picture Mode

Press [UP/DOWN] button to select **Picture Mode**, then press & Enter button to select. (Optional: Standard/ Cinema Day/Cinema night/Dynamic/Sports).

- | | |
|---------------------|--|
| <i>Standard</i> | The default mode, to make users experience high-quality images under normal light. |
| <i>Cinema day</i> | Enhance the contrast, colour, and clarity of the screen to make the colour more vivid. |
| <i>Cinema night</i> | Reduce the screen contrast, colour, and clarity to make the screen looks soft. |
| <i>Dynamic</i> | Enhance the contrast, colour, and clarity of the screen, so that the picture in the dynamic will balance the colour. |
| <i>Sports</i> | This mode is more suitable for watching sport video. |

4.2 Aspect Ratio

Adjust the Aspect Ratio to stretch or zoom in on your picture.

Press button to select Aspect Ratio.

Press button to select Automatic/16:9/4:3/Panoramic/Movie Zoom/Direct.

Game Mode

Press to select, and press to select On/Off.

Picture Mode Settings

Press ▲▼ to select, and press ► and OK to enter.

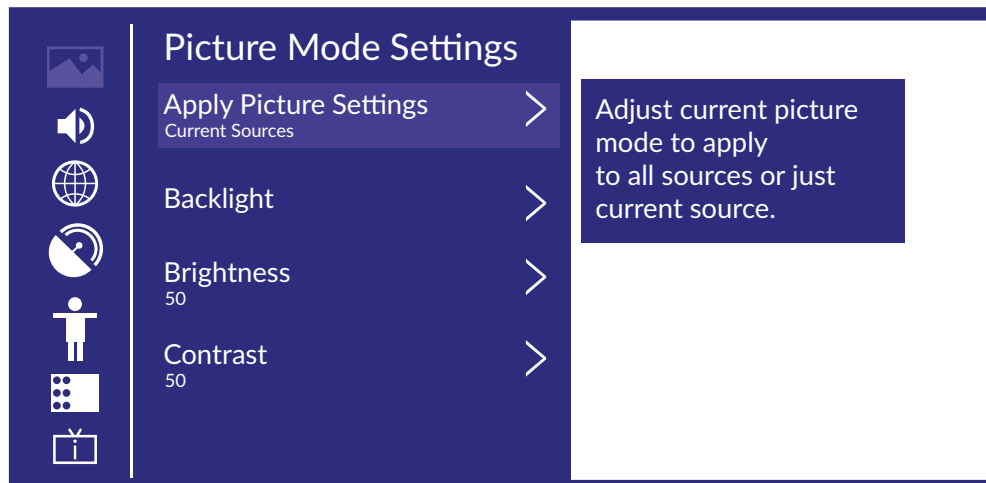

4.3 Apply Picture Settings

In this menu, you can adjust current picture mode to apply to all sources or just current source.

Press ▲▼ to select, and press ► and OK to enter.

(Optional: All Sources/Current Source)

Backlight/Brightness/Contrast/Colour Saturation/Sharpness

Press ▲▼ to select, and press ◀▶ to adjust.

<i>Backlight</i>	Adjust image backlight. (Optional: Off/Low/High)
<i>Brightness</i>	Adjust image brightness.
<i>Contrast</i>	Adjust image contrast.
<i>Colour Saturation</i>	Adjust image color density.
<i>Sharpness</i>	Adjust the image edge sharpness.

Adaptive Contrast

In this menu, you can automatically darken dark areas and lighten light areas of images to see more details

Press ▲▼ to select *Adaptive Contrast* and press ◀▶ to select Off/Low/Medium/High.

Noise Reduction

Set up the options to eliminate the image noise intensity.

Press ▲▼ to select *Noise Reduction*.

Press ◀▶ to select Off/Low/Medium/High.

MPEG Noise Reduction

Set up the options to eliminate the MPEG noise intensity.

Press ▲▼ to select *Noise Reduction*.

Press ◀▶ to select Off/Low/Medium/High.

Colour Temperature

Adjust the overall colour of the image.

Press ▲▼ to select the *Colour Temperature*.

Press ◀▶ to select Warm1/Warm2/Standard/Cool.

Expert Settings

Adjust the colour space and Gamma to best suit the content you are viewing.

Press ▲▼ to select *Expert Settings*.

Press ◀▶ to enter the *sub-menu*.

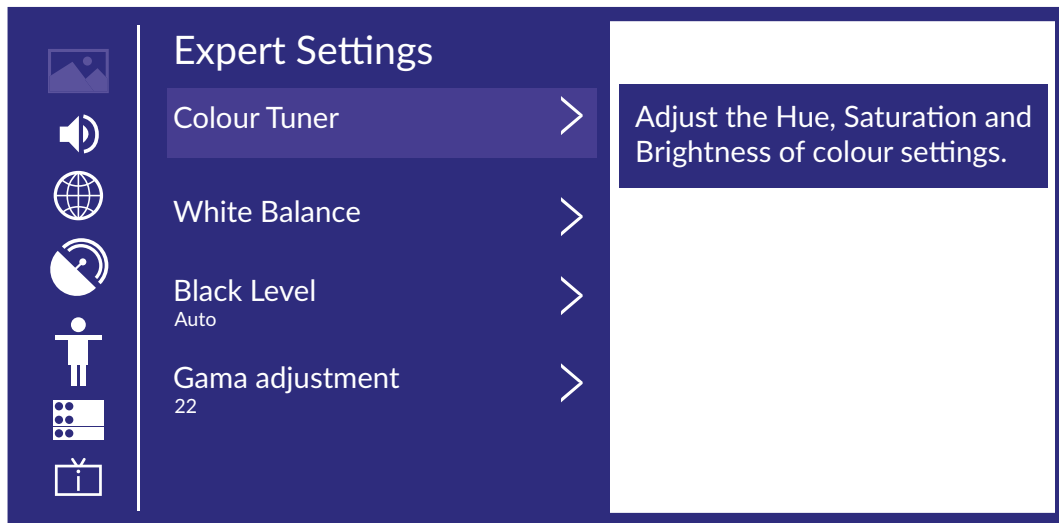

Colour Tuner

Adjust the Hue, saturation, and brightness of the colour settings.

Press [UP/DOWN] to select {Colour Tuner}.

Press ◀▶ button to enter the {sub-menu} and adjust.

White Balance

Adjust the intensity of red, green and blue lights to view the true colours of all images in the picture.

Press ▲▼ to select *White Balance*.

Press ◀▶ to enter and adjust.

Black Level (Only available on HDMI source)

In this menu, you can adjust the HDMI signal range to be more suitable for content.

Press ▲▼ to select Black Level. Press ◀▶ to select.

Gamma Adjustment

Press ▲▼ to select *Gamma Adjustment*.

Press ◀▶ to select 2.0/2.2/2.4/BT.1886.

Gamma Calibration

In this menu, you can adjust the Gamma curve which one you selected.

Press ▲▼ to select *Gamma Calibration*.

Press ◀▶ to enter *sub-menu* to adjust.

RGB Only Mode

Press ▲▼ to select *RGB Only Mode*.

Press ◀▶ to select *Off/Red/Green/Blue*.

Low Blue Light

Press ▲▼ to select *Low Blue Light*.

Press ◀▶ to select *Off/Low/Middle/High/Very High*.

Overscan

Press ▲▼ to select *Overscan*.

Press ◀▶ to select *On/Off*.

Reset Current Mode

Press ▲▼ button to select *Reset Current Mode*.

Press ◀▶ button to enter *sub-menu*.

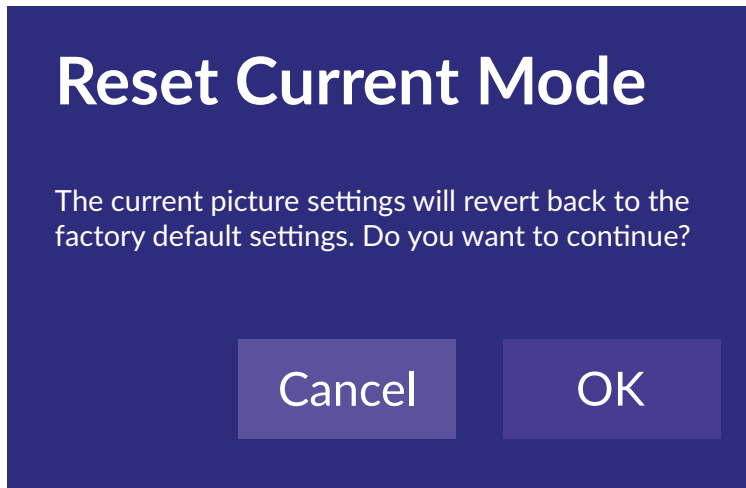

5. SOUND

Press button to display the main menu. Press to select *Sound* in the main menu.

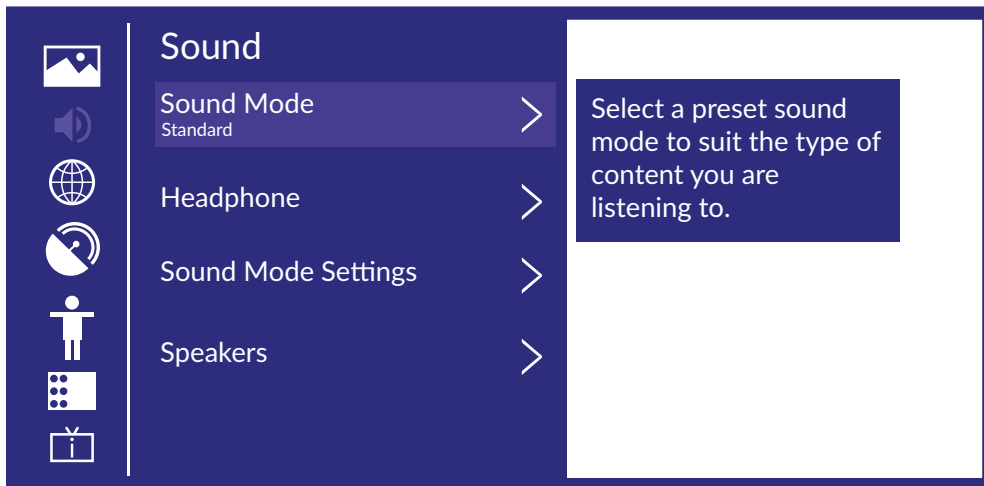

1. Press to select the option that you want to adjust in the *Sound* menu.
2. Press OK to adjust.
3. After finishing your adjustment, Press OK to save and return to the previous menu.

5.1 Sound Mode

Press to select your favourite sound mode.
(Optional: Standard/Theatre/Music/Speech/Late Night/Sports.)

Standard Theatre

Produces a balanced sound in all environments.
Theatre mode increases the surround sound effect and provides a more prominent subwoofer response.

Music Speech

Preserves the original sound and is good for musical programs.
Low and high frequencies are attenuated to improve the reproduction and clarity of the human voice.

Late Night Sports

Improve the reproduction and clarity of the human voice with a low volume level.
Optimised sound for watching football game.

5.2 Headphone

Press to select *Headphone*. It is only available when headphones are plugged in. It can set the sound output mode through headphones.

5.3 Sound Mode Settings

Press ▲▼ to select *Sound Mode Settings*.

Press ◀▶ to enter sub-menu.

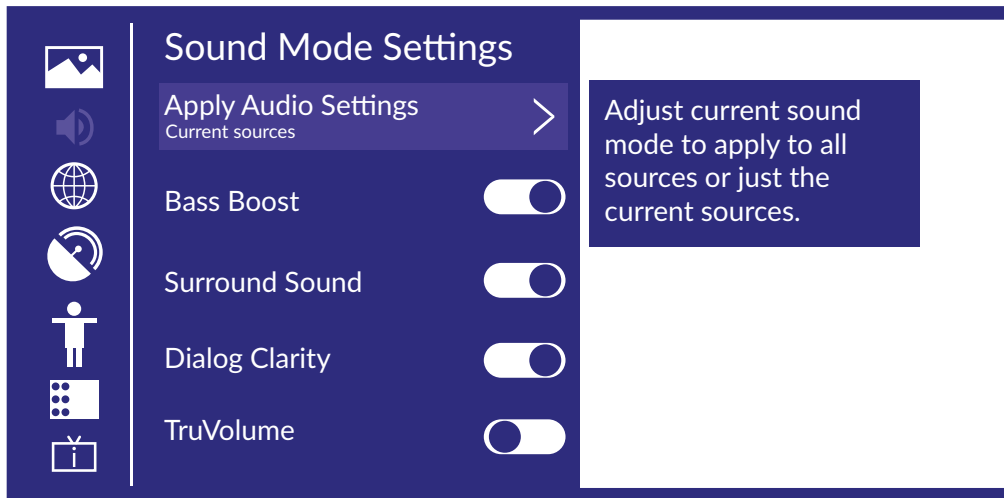

Apply Audio Settings

Adjust the Current sound mode to apply to all source or just current source.

Press ▲▼ to select, then press ▶ and OK to select *Current Source/All Sources*.

Equalizer

Press ◀▶ to select and adjust *Equalizer* detail.

(Optional:100Hz/500Hz/1.5KHz/5KHz/10KHz)

Bass Boost/Surround Sound/Dialog Clarity/True Volume/ Wall Mount Setup/Auto Volume Control

Press ▲▼ to select and press ◀▶ to select On/Off.

Reset Current Mode

Press ▲▼ to select and press ◀▶ to choose restore or not.

Speakers

Press ▲▼ to select *Speakers*.

Press ◀▶ to enter *sub-menu*.

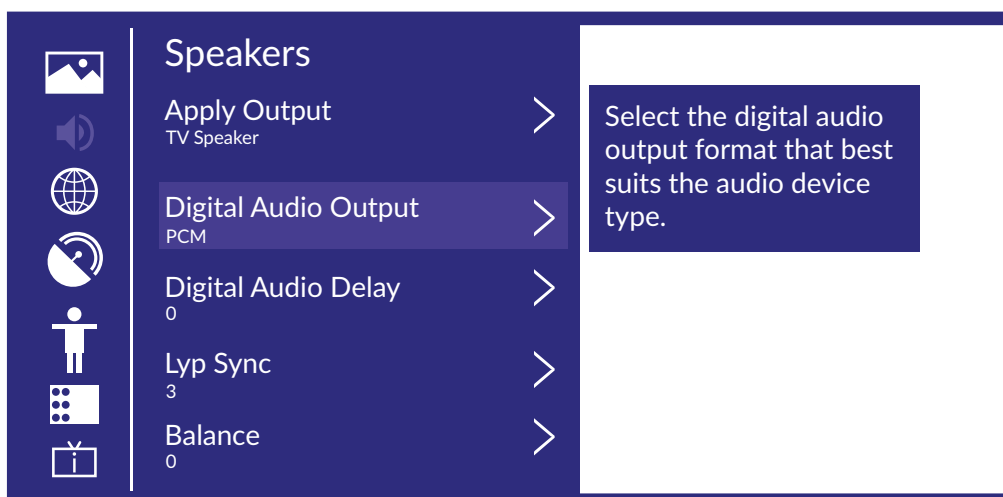

Audio Output

Press ▲▼ to select Audio Output and enter, then press ▲▼ to select ARC/TV Speaker/SPDIF Only.

Digital Audio Output

Press ▲▼ button to select Digital Audio Out, then press ▲▼ to select.

Digital Audio Delay

Press ▲▼ to select Digital Audio Delay, then press ▲▼ to adjust.

Lip Sync

Press ▲▼ to select, then press ◀▶ to adjust.

Balanced left and right channels.

Press ▲▼ to select Balance. Press ◀▶ to adjust.

6. NETWORK

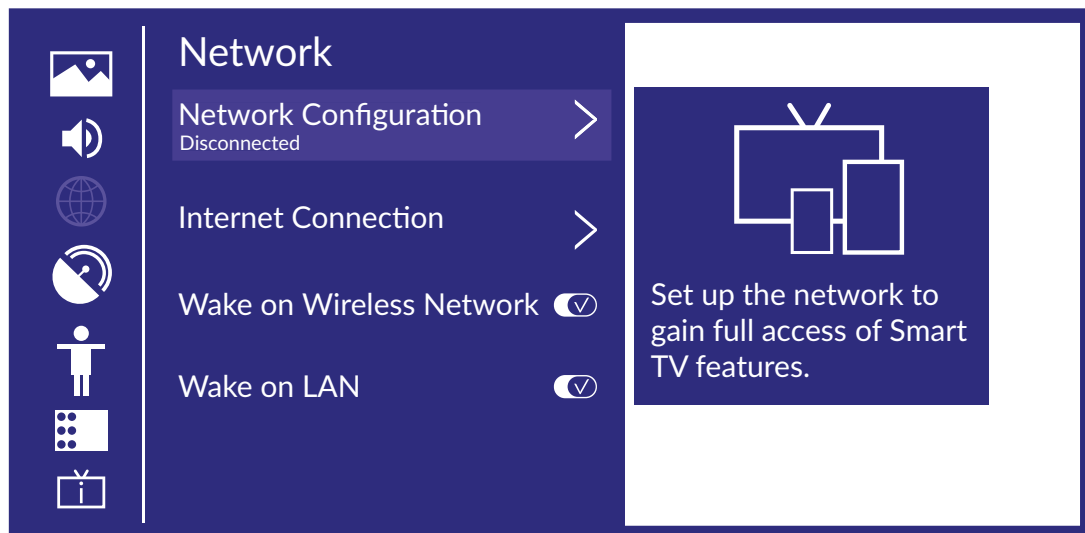

Press the ☰ button to display the main menu. Press ▲▼ to select *Network* in the main menu. Press ▲▼ to select: *Network Configuration/Internet Connection* Wake on Wireless Network/Wake on LAN.

Network Configuration

Press ▲▼ to select *Network Configuration* to set up the network.

Internet Connection

Press ▲▼ to select *Internet Connection* to check Internet Connection.

Wake on Wireless Network

Press ▲▼ to select *Wake on Wireless Network*, then press ◀▶ to select *On/Off*.

Wake on LAN

Press ▲▼ to select *Wake on LAN*. Press ◀▶ to select *On/Off*.

7. CHANNEL

Press  button to display the main menu.  to select *Channel*.

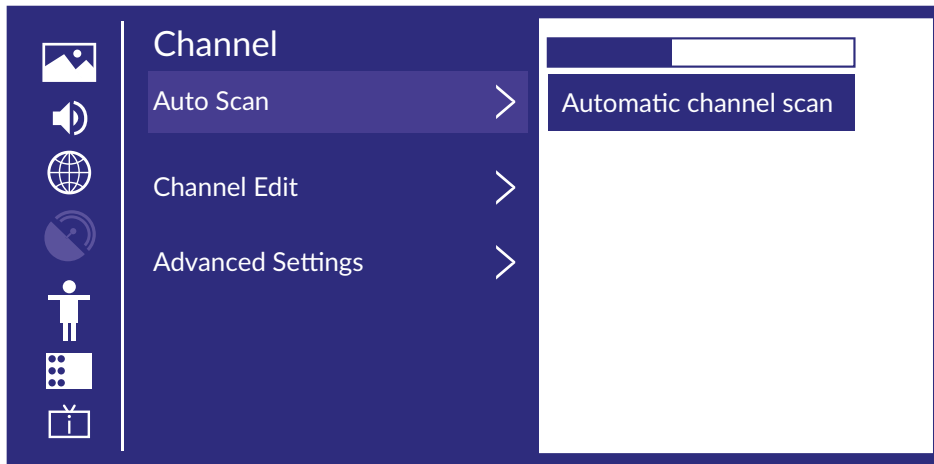

1. Press  to select the option that you want to adjust in the Channel menu.
2. Press OK to adjust.
3. After finishing your adjustment. Press OK to save and return to the previous menu.

Auto Scan

Automatic search can search for effective program channel automatically.
Press  to select Auto Scan, then press OK to setup.

Rescan

In this page you can choose rescan channel or change setup.

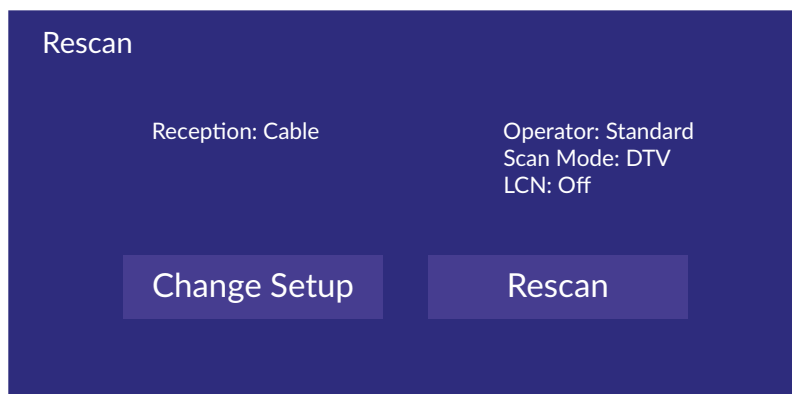

Reception

Press  button to select Reception and press  to select *Satellite/Antenna/Cable*.

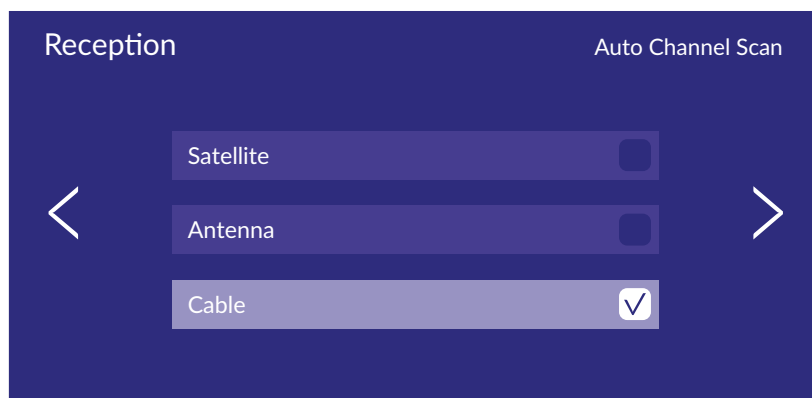

Operator

Press ◀▶ to select and press ▲▼ to setup.

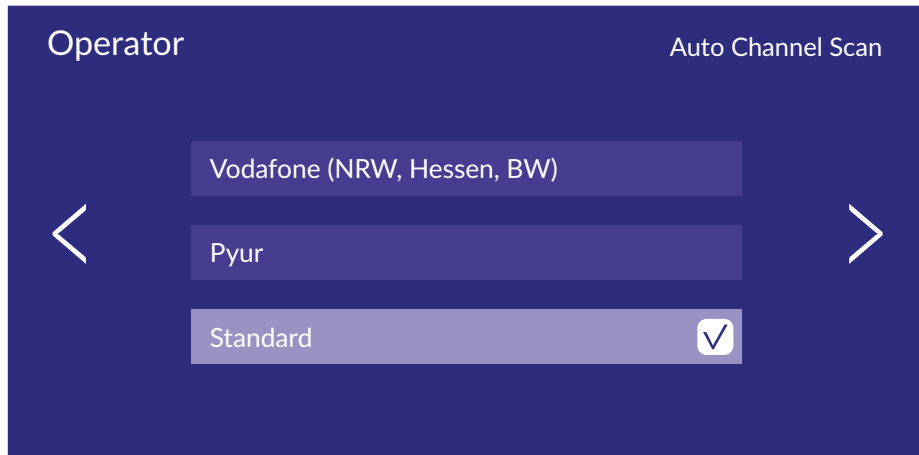

Mode setup

Press ◀▶ to select *Mode setup* and press ▲▼ to select *Channel/Scan Mode/LCN*.

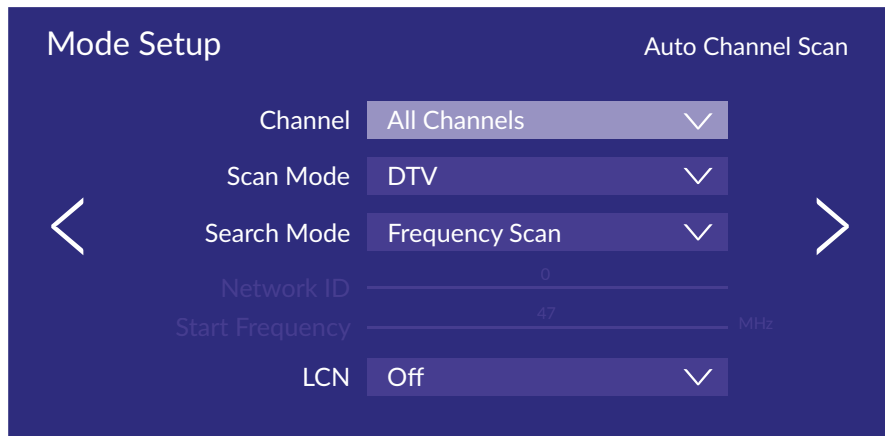

Auto Scan

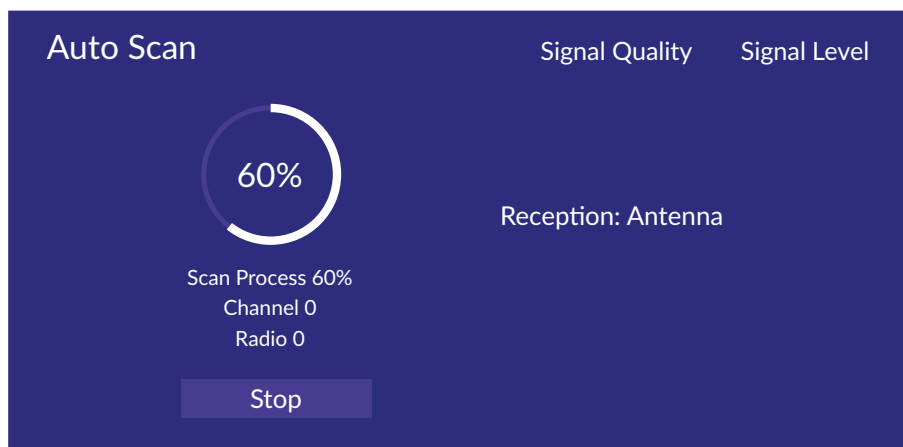

If you want to stop searching, press ▶|| or EXIT button to stop searching.

Channel Edit

Press ▲▼ to select *Channel Edit*.

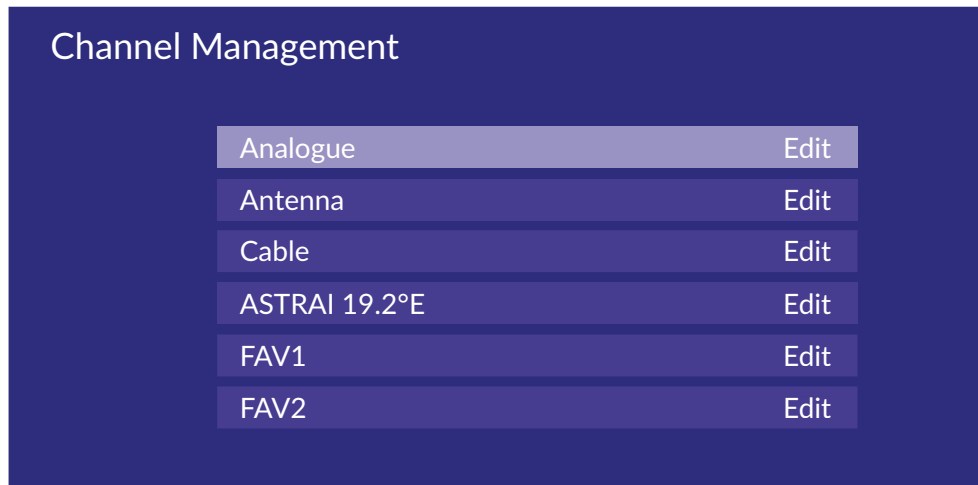

Advanced Settings

Press ▲▼ to select *Advanced Settings* and then press OK / ► to enter.

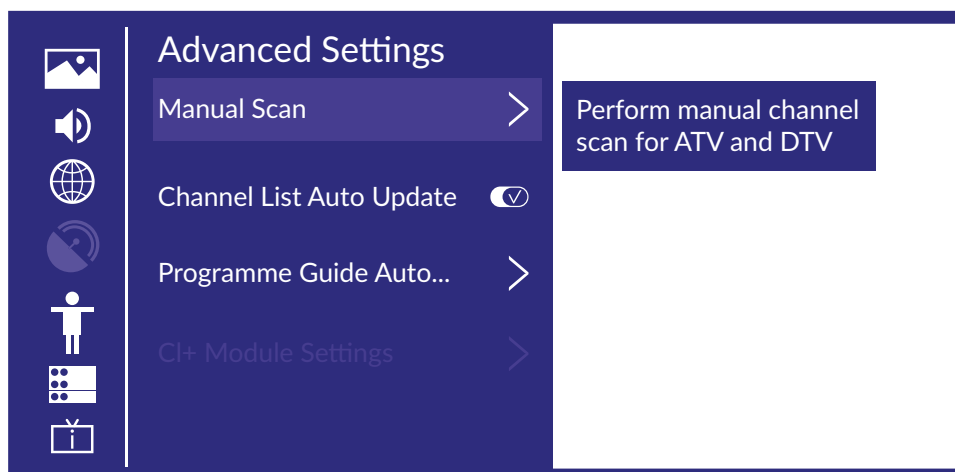

Manual Scan

Press ▲▼ to select *Manual Scan* and then press OK to enter.

Press ▲▼ to select *DTV Manual Scan/ATV Manual Scan*.

DTV Manual Scan

Press ▲▼ to select *DTV Manual Scan*, then press OK to enter.

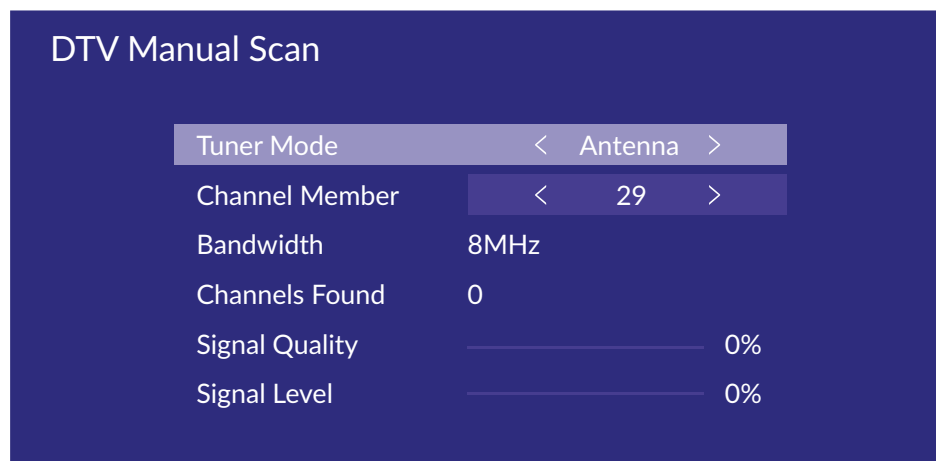

ATV Manual Scan

Press ▲▼ to select *ATV Manual Scan* and then press OK to enter.

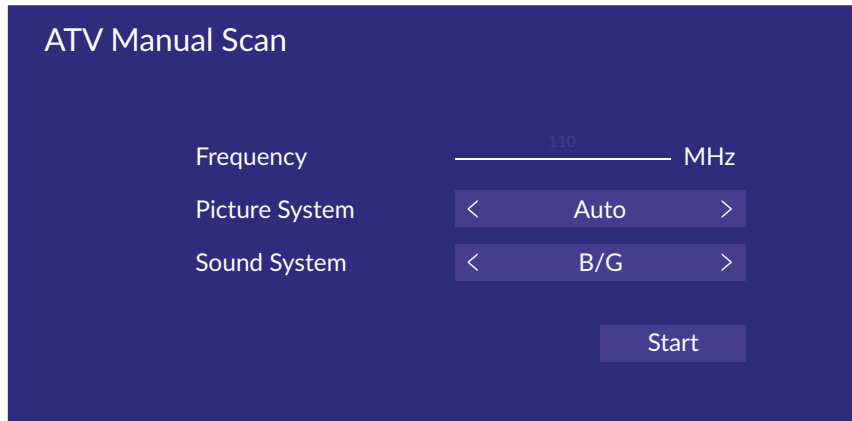

Channel List Auto-Update

Press ▲▼ to select *Channel List Auto-Update*, then press ◀▶ to select *On/Off*.

Programme Guide Auto Update

Press ▲▼ to select *Programme Auto Update*.

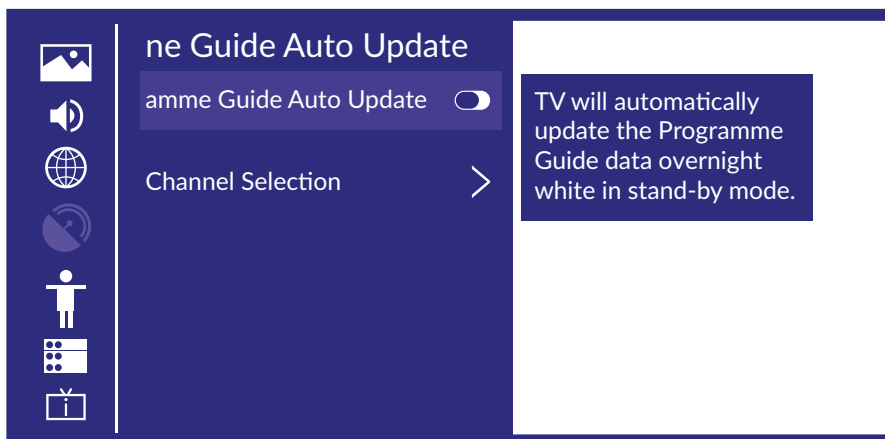

Programme Auto Update

Press ▲▼ to select *Channel List Auto-Update*, then press ◀▶ to select *On/Off*.

Channel Selection

Press ▲▼ to select *Channel Selection*.

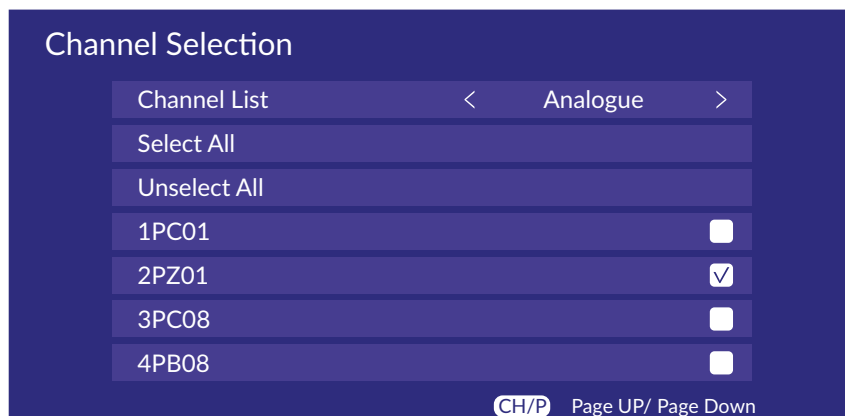

CI+ Module Settings

Press ▲▼ to select *CI+ Module Settings* and you can review the advanced settings menu.

Accessibility

Press ▲▼ to select *Accessibility*, then press OK to enter.

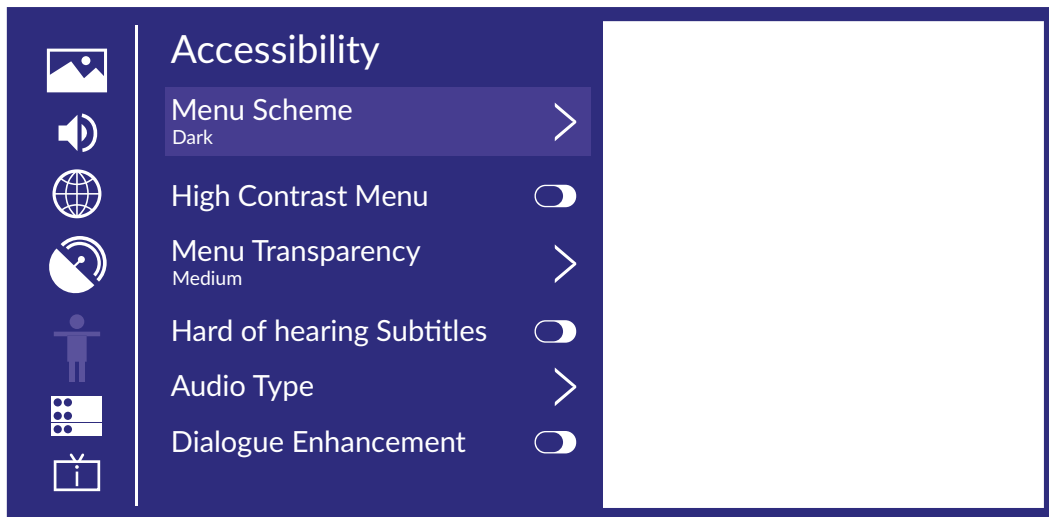

Menu Scheme

Press ▲▼ to select *Menu Scheme*, then press ◀▶ to choose Dark/Light.

High Contrast Menu

Press ▲▼ to select *High Contrast Menu*, then press ◀▶ to select On/Off.

Menu Transparency

Press ▲▼ to select *Menu Transparency*, then press ◀▶ to choose Off/Medium/High.

Hard of Hearing Subtitles

Press ▲▼ to select *Hard of Hearing Subtitles*, then press ◀▶ button to select On/Off.

Audio Type

Press ▲▼ to select *Audio Type*, then press OK button to enter sub-menu.

Audio Type

Press ▲▼ to select *Audio Type* then press ◀▶ to select Normal/Audio Description/ Spoken Subtitles/All Supplementary Audio.

Voiceover Volume

Press ▲▼ to select *Voiceover Volume*, then press ◀▶ to select On/Off.

Dialogue Enhancement

Press ▲▼ to select *Dialogue Enhancement*, then press OK to enter sub-menu.

8. SYSTEM

Press the  button to display the main menu. Press  to select *System* in the main menu.

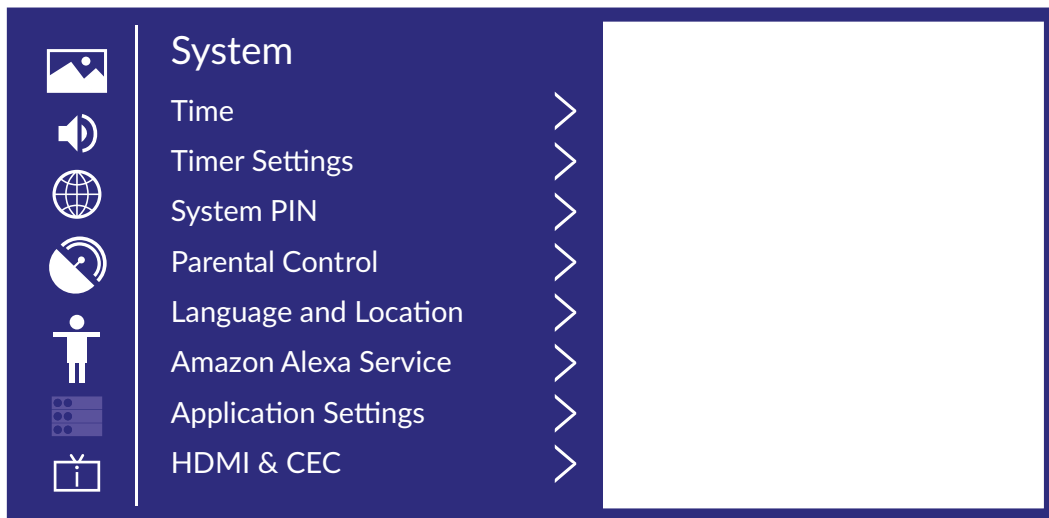

1. Press  to select the option that you want to adjust in the System menu.
2. Press OK to adjust.
3. After finishing your adjustment, press OK to save and return to the previous menu.

Time

Press  to select *Time*.

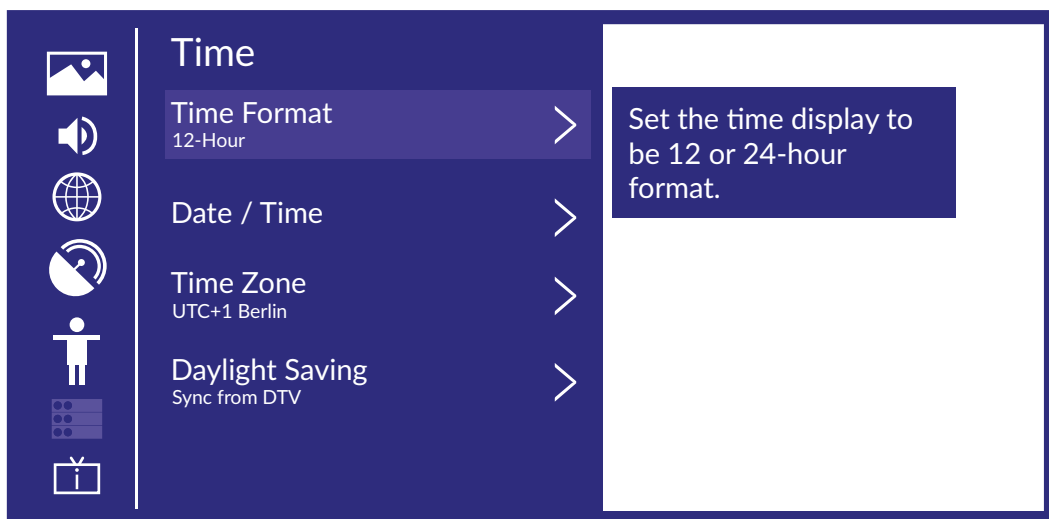

Time Format

Press  button to select *Time Format*. (Optional: 12-hour/24-hour)

Date/Time

Set the Date and Time

Press  button to select *Date/Time* then press OK /  to setup.

Time Zone

Select your time zone

Press  button to select *Time zone*, then press OK /  to enter sub-menu to setup.

Daylight Savings

Press  button to select *Daylight Savings*. (Optional: Off/On/Sync from DTV)

Timer Settings

Press ▲▼ to select Timer Settings.

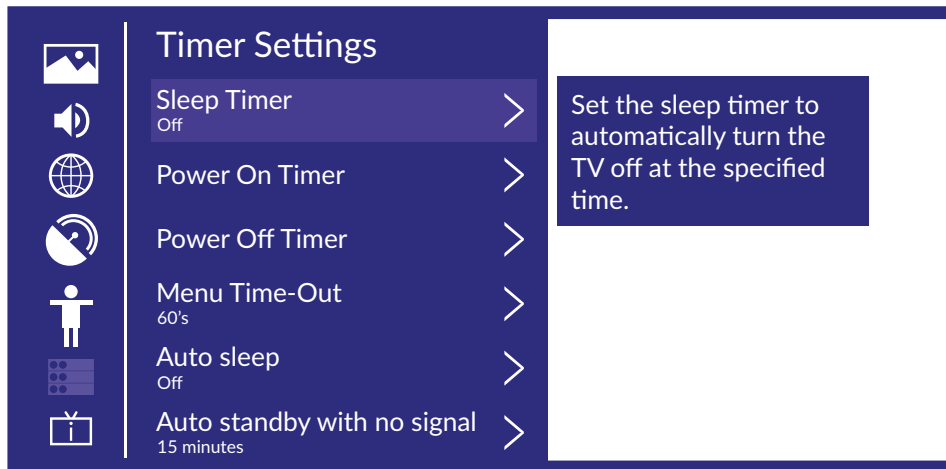

Sleep Timer

Press ▲▼ to select *Sleep Timer*.

(Optional: Off/15/30/60/90/120 Minutes/User Defined)

Power On Timer

Press ▲▼ to select *Power On Timer*.

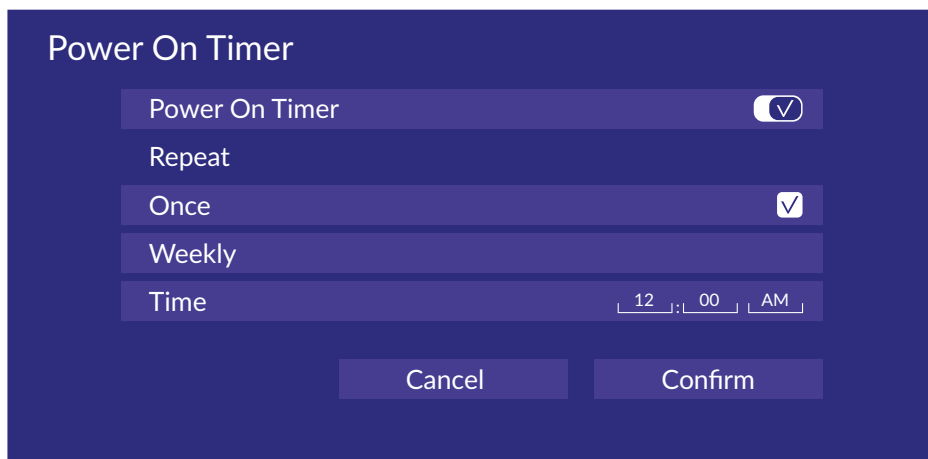

Power Off

Press ▲▼ to select *Power Off Timer*.

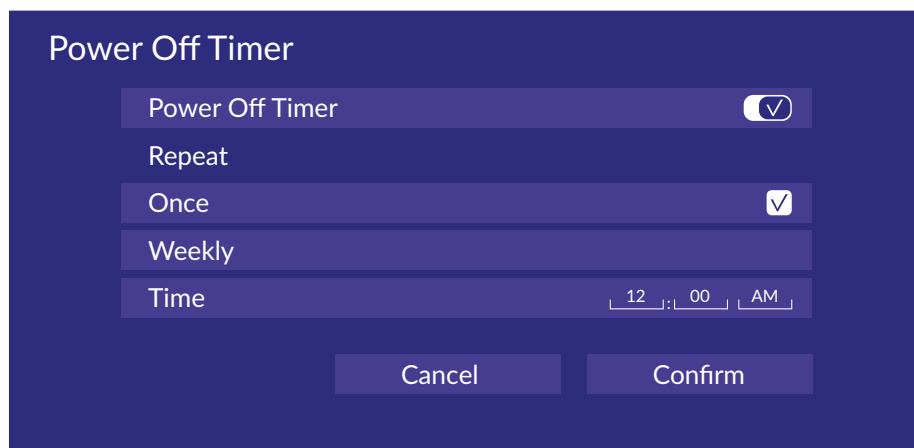

Menu Timeout

Press ▲▼ to select *Menu Timeout*. (Optional: Off/10s/20s/30s/60s/5min)

Auto Sleep

Press ▲▼ to select *Auto Sleep*.
(Optional: Off/3H/4H)

Auto Standby with No Signal

Press ▲▼ to select *Auto Standby with No Signal*.
(Optional: Off/15 Minutes)

System PIN

Press ▲▼ button to select *System PIN*.
Change your PIN that you use to access *Parental Controls, Auto Channel Scan and Reset to Factory Defaults*.

Parental Control

Press ▲▼ to select *Parental Control*.
Turn on *Parental Controls* to block children from being able to view certain programmes.

Language and Location

Press ▲▼ to select *Language and Location*.

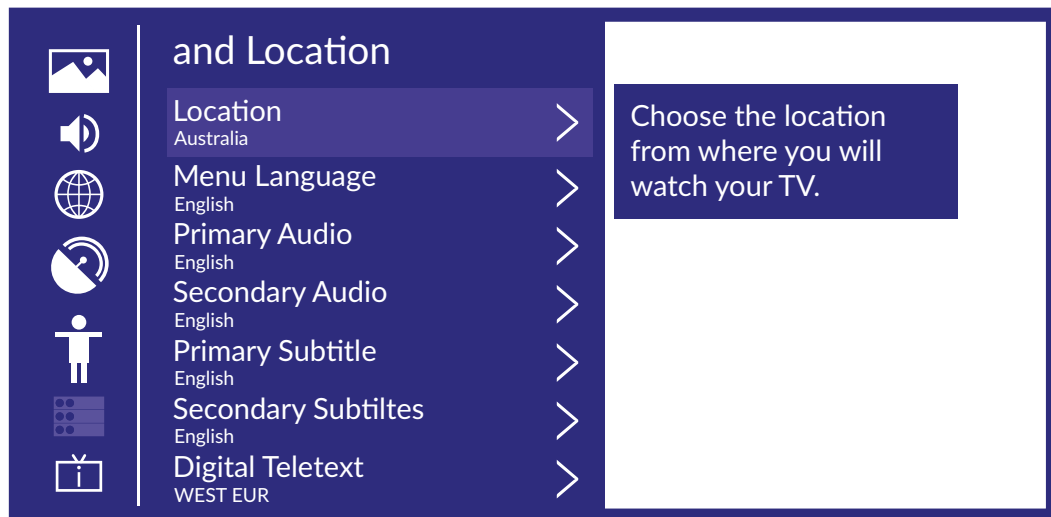

Location

Press ▲▼ to select *Location*, and press OK/▶ to select.

Menu Language

Press ▲▼ to select *Menu Language*, and press OK/▶ to select.

Primary Audio

Press ▲▼ to select *Primary Audio*, and press OK/▶ to select.

Secondary Audio

Press ▲▼ to select *Secondary Audio*, and press OK/▶ to select.

Primary Subtitle

Press ▲▼ to select *Primary Subtitle*, and press OK/▶ to select.

Secondary Subtitle

Press ▲▼ to select *Secondary Subtitle*, and press OK/▶ to select.

Digital Teletext

Press ▲▼ to select *Digital Teletext*. (Optional: WEST EUR/EAST EUR/Russian/Aarabic/Persian/Greek)

Amazon Alexa Service

Press ▲▼ to select *Amazon Alexa Service* and press ▲▼ to enter sub-menu and setup.

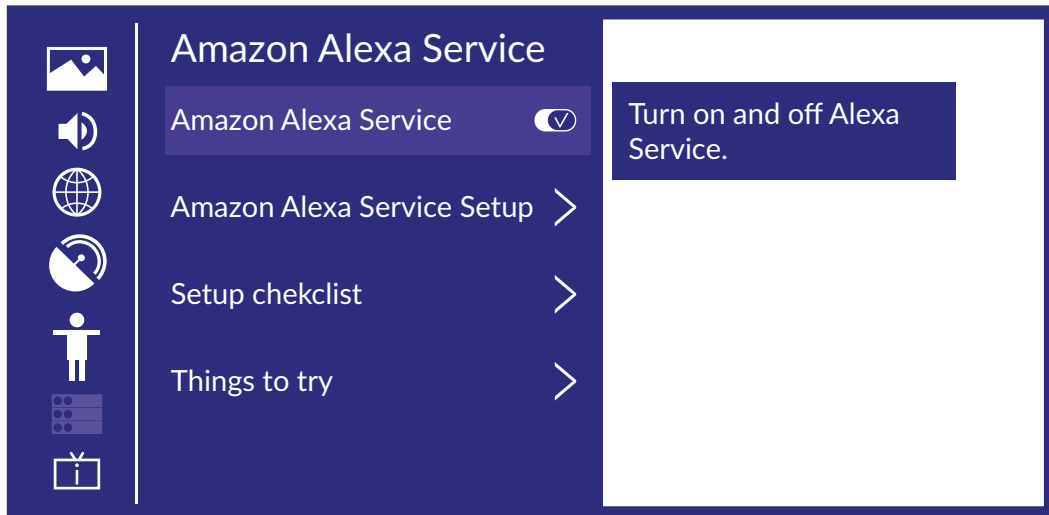

Application Settings

Press ▲▼ to select *Application Settings*.

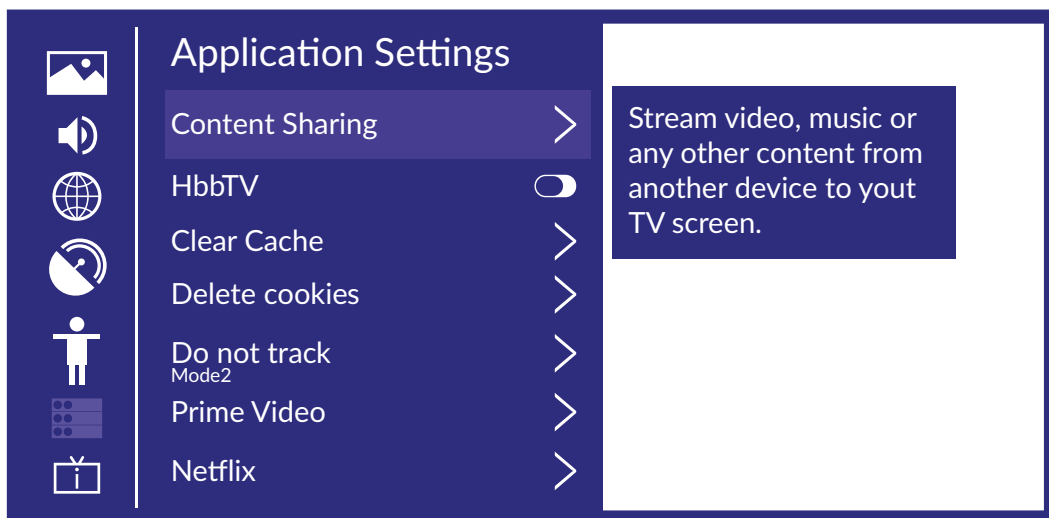

Content Sharing

Press ▲▼ to select *Content Sharing*, then press ◀▶ to select On/Off.

Hbb TV

Press ▲▼ to select *Hbb TV*, then press ◀▶ to select Off/On.

Clear Cache

Press ▲▼ to select *Clear Cache*, then press OK/▶ to enter sub-menu.

Delete Cookies

Press ▲▼ to select *Delete Cookies*, then press OK/▶ to enter sub-menu.

Do Not Track

Press ▲▼ to select *Do Not Track*, then press OK/▶ to enter sub-menu.

Prime Video

Press ▲▼ to select *Prime Video*, and press OK/▶ to select.

Netflix

Press ▲▼ to select *Netflix*, and press OK/▶ to select.

HDMI&CEC

Press ▲▼ to select *HDMI & CEC*, then press Enter button to enter sub-menu to select.

Press ▲▼ to select *CEC Control/Device Auto Power Off/Device Auto Power On/TV Auto Power On/CEC Device Lists*.

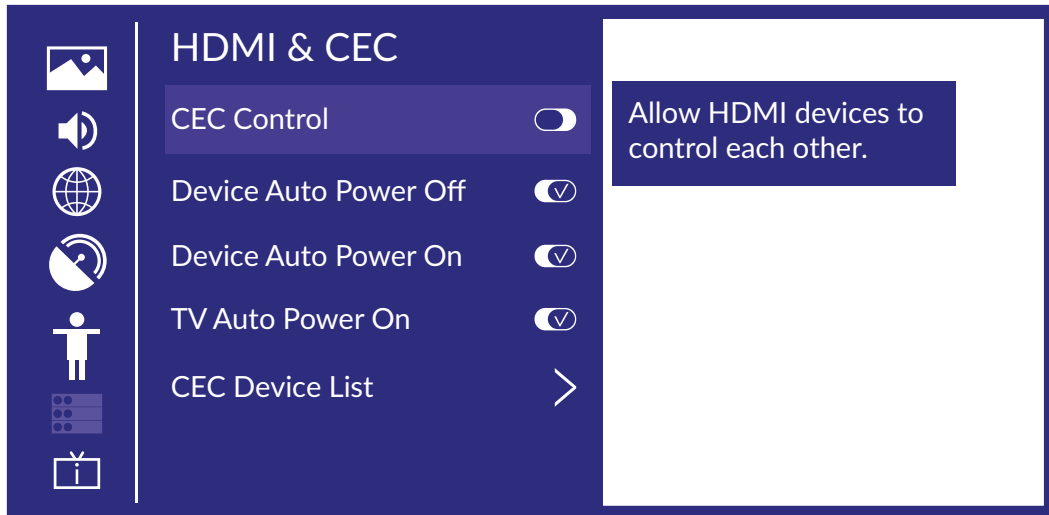

NOTE: All the Options are available only when the CEC Control select On.

CEC Control

Press ▲▼ to select *CEC Control*, and press ◀▶ to select On/Off.

The following terms are available only when "On" is selected in CEC Control.

Device Auto Power Off

Press ▲▼ to select *Device Power Off*, and press ◀▶ to select Off/On.

Device Auto Power On

Press ▲▼ to select *Device Auto Power On*, and press ◀▶ button to select Off/On.

Tv Auto Power On

Press ▲▼ to select *TV Auto Power On*, and press ◀▶ to select Off/On.

CEC Device

Press ▲▼ button to select **CEC Device Lists**, and press OK to enter.

Usage Mode

Press ▲▼ to select *Usage Mode*, then press OK/▶ select to Home Mode/Store Mode.

Advanced Settings

Press ▲▼ to select *Advanced Settings*, then press OK/▶ to enter.

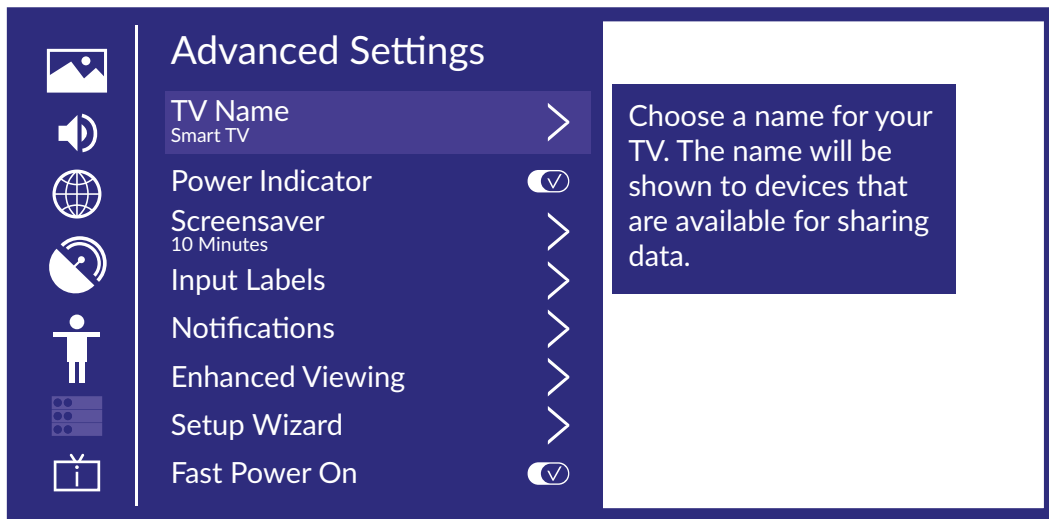

TV Name

Press ▲▼ to select *TV Name*, then press OK/▶ to setup your TV name.

Power Indicator

Press ▲▼ to select *Power Indicator*, then press ◀▶ to select *Off/On*.

Screen saver

Press ▲▼ to select *Screen saver*, then press OK/▶ to enter.
(Optional:None/5 Minutes/10 Minutes/20 Minutes)

Input Labels

Press ▲▼ to select *Input Labels*, then press OK/▶ to enter.
(Optional:TV/AV/HDMI1/HDMI2/HDMI3)

Notifications

Press ▲▼ to select *Notifications*, then press OK/▶ to enter sub-menu and select.

Enhanced Viewing

Press ▲▼ to select *Enhanced Viewing*, then press OK/▶ to enter sub-menu and select.

Setup Wizard

Press ▲▼ to select *Setup Wizard*, then press OK/▶ to select.

Fast Power On

Press ▲▼ to select *Fast Power On*, then press OK/▶ to select *Off/On*.

Power On Mode

Press ▲▼ to select *Power On Mode*, then press OK/▶ to select.

Support

Press ▲▼ to select *Support*, then press OK/▶ to enter.

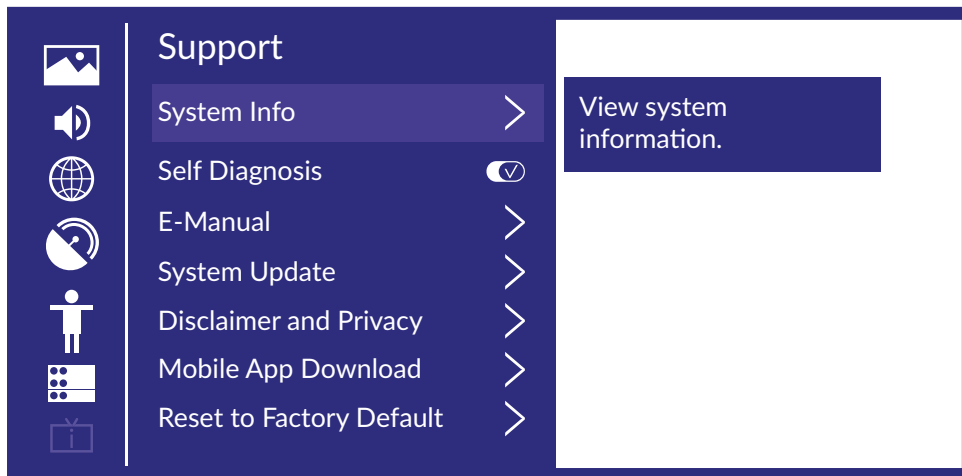

System Info

View System information

Press ▲▼ to select **System Info**, then press OK/▶ to enter sub-menu.

Self Diagnosis

Perform self-diagnosis to test sound, picture and connections.

Press ▲▼ to select *Self Diagnosis*, then press OK/▶ to enter sub-menu.

E-Manual

Press ▲▼ to select *E-Manual*, then press OK/▶ to enter sub-menu.

System Update

Set your TV to receive the latest firmware.

Press ▲▼ to select *System Update*, then press OK/▶ to enter sub-menu.

Disclaimer and Privacy

Click to read the Disclaimer details.

Press ▲▼ to select *Disclaimer and Privacy*, then press OK/▶ to enter sub-menu.

Mobile App Download

Press ▲▼ to select *Mobile App Download*, then press OK/▶ to enter sub-menu.

Restore To Factory Default

Press ▲▼ to select *Restore To Factory Default*, then press OK/▶ to enter sub-menu and select. Press  button to wakeup Menu, then press ▲▼ to select.

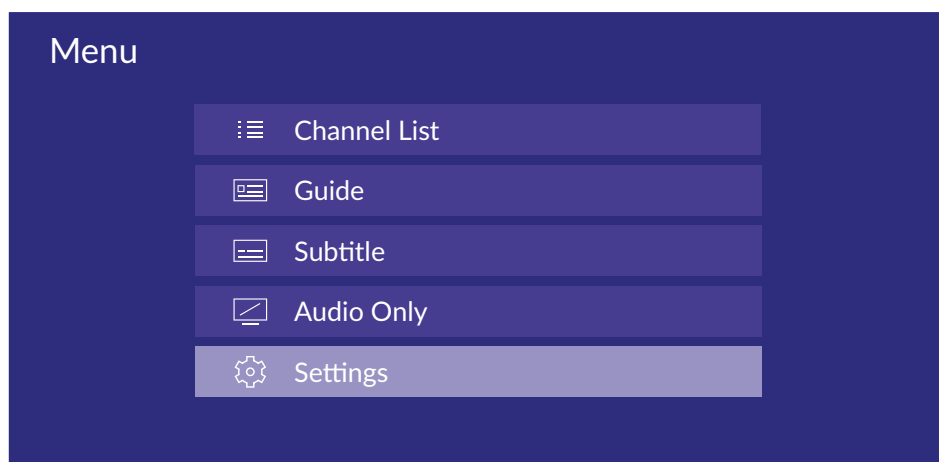

Channel List

Press ▲▼ to select *Channel List*, then press OK to enter sub-menu.

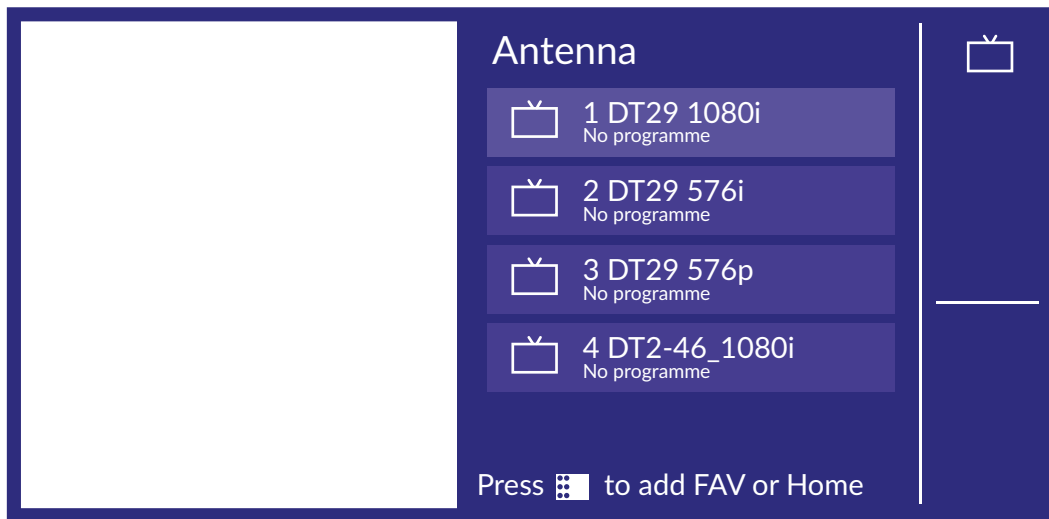

Subtitle

Press ▲▼ to select Subtitle, then press ▲▼ to select *Off/On*.

Audio Only

Press ▲▼ to select Audio Only. Press OK to enter the sub-menu.

Settings

Press ▲▼ to select Settings. Press OK to enter the sub-menu.
Please refer to the home page - Setting part

Guide

Press ▲▼ to select Guide, then press OK to enter sub-menu.

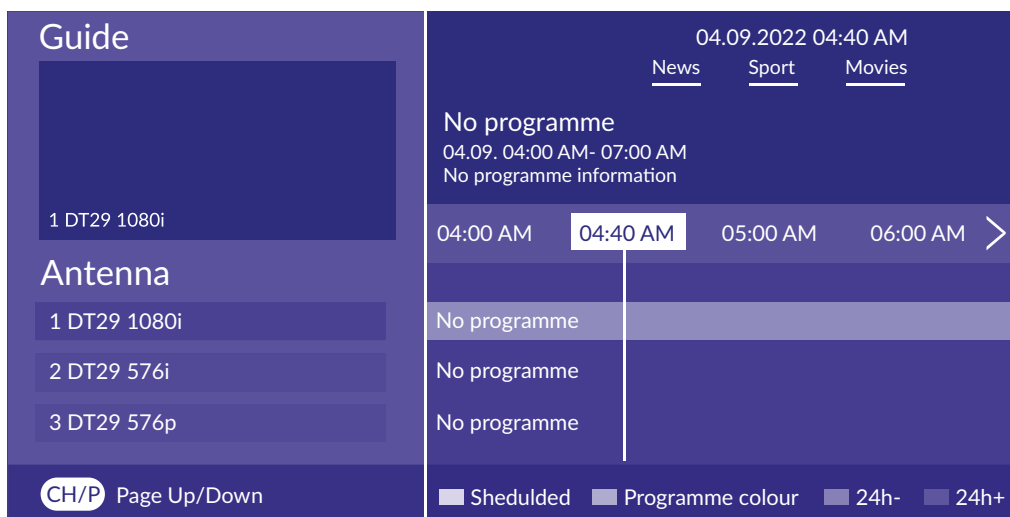

Subtitle

Press ▲▼ to select *Subtitle*, then press ▲▼ to select *Off/On*.

Audio Only

Press ▲▼ to select *Audio Only*. Press OK enter the sub-menu.

Settings

Press ▲▼ to select *Settings*. Press OK enter the sub-menu.
Please refer to the home page - Setting part

9. MEDIA

To use this function, you must have inserted in the USB port an USB device loaded with your multimedia files. Press **INPUT** and then **▲▼◀▶** **OK** to select **USB** to access your media.

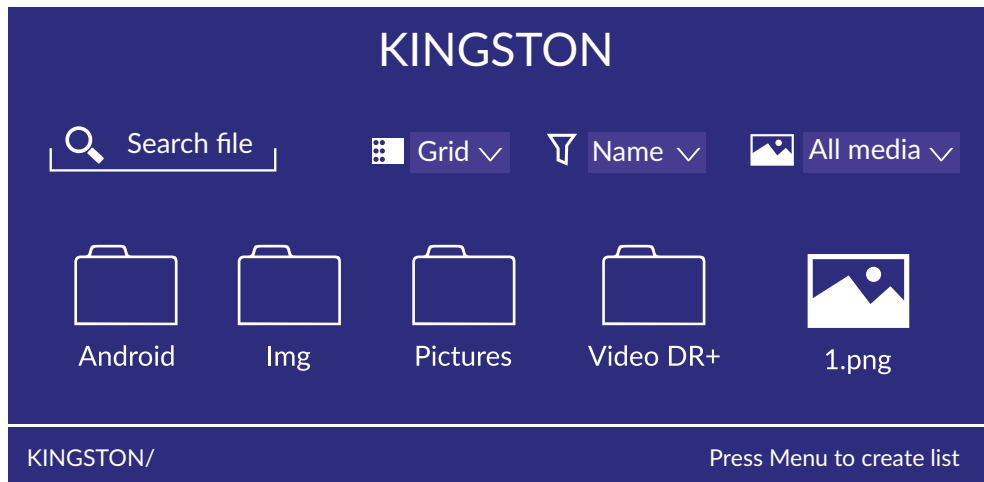

Video

Press **▲▼** to select *Video or All*, and press **▲▼◀▶** to select *Movies*. Press **☰** button to display the setting options on the left side.

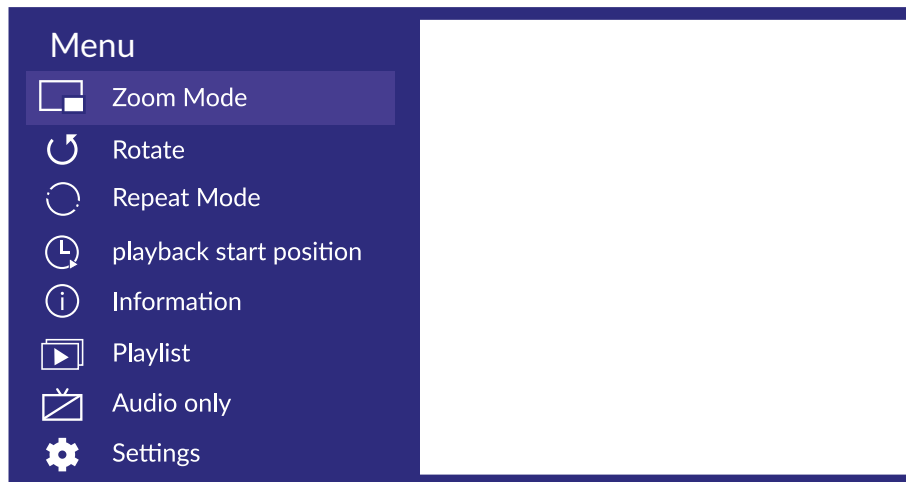

Zoom Mode

Press **▲▼** to select *Zoom Mode*, and press **OK** to select. *Optional:Fit/Full/Original Size*

Rotate

Press **▲▼** to select *Rotate*, and press **OK** to select.
Options:Right 90°/Left 90°

Audio Only

Press **▲▼** to select *Audio Only*, and press **OK** to select.

Repeat Mode

Press **▲▼** to select *Repeat Mode*, and press **OK** to select.
Optional:No Repeat/Repeat Current/Repeat All

Playback start position

Press **▲▼** to select *Playback start position*, and press **OK** to select.

Information

Press ▲▼ to select *Information*, and press OK to view.

Play List

Press ▲▼ to select *Play List*, and press OK to display all available videos.

Audio Only

Press ▲▼ to select *Audio Only*, and press OK to select.

Audio

Press ▲▼ to select *Audio or All*, and press ▲▼◀▶ button to select *Music*.

Information

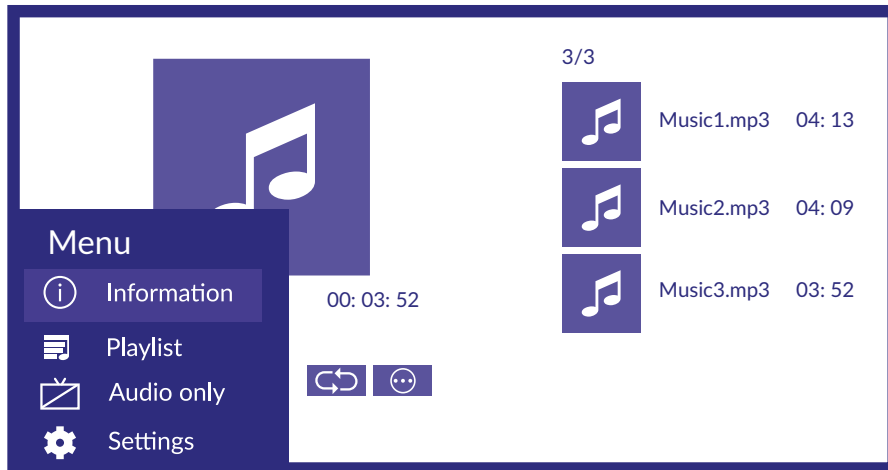

Press ▲▼ to select *Information*, and press OK to view.

Play List

Press ▲▼ to select *Play List*, and press OK to display all available videos. *Optional:Pause/Repeat All/Edit*

Audio Only

Press ▲▼ to select *Audio Only*, and press OK to select.

Image

Press ▲▼ button to select *Image or All*, and press ▲▼◀▶ to select *Picture*.

Zoom Mode

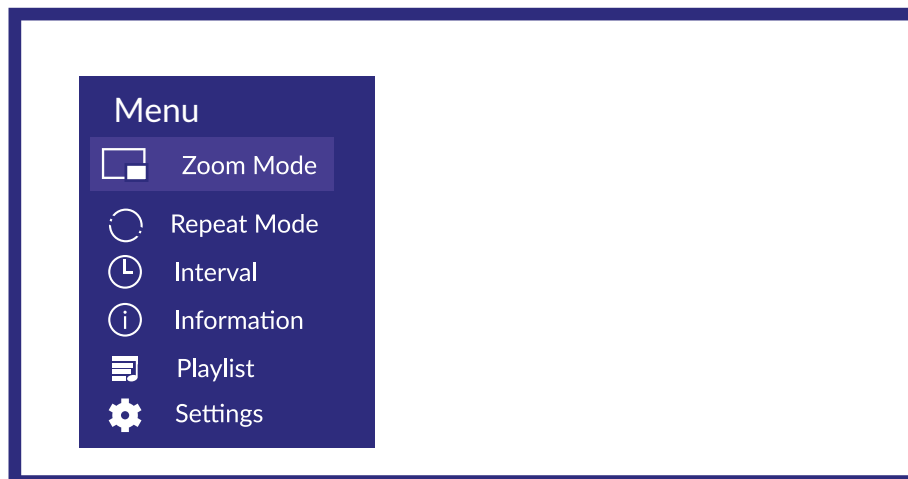

Press ▲▼ to select *Zoom Mode* and press OK to select.
Optional: Fit/Original Size

Repeat Mode

Press ▲▼ to select *Repeat Mode* and press OK to select.
Optional: No Repeat/Repeat All

Interval

Press ▲▼ to select *Ineterval* and press OK to select.
(Optional:5S/10S/20S)

Information

Press ▲▼ to select *Information*, and press OK to view.

Play List

Press ▲▼ to select *Play List*, and press OK to display all available Picture.

10. TROUBLESHOOTING

Before calling a service technician, review following information for possible causes and solutions for the problem you are experiencing. If the TV does not work properly after checking it, please contact your local service line or STRONG dealer. Alternatively, you can send a support mail via our website www.strong.tv.

Problem	Possible cause and solution
TV do not switch ON	<ol style="list-style-type: none"> 1. Check if wall outlet is functioning 2. Plug another electrical device into the outlet to make sure it is working or turned on.
The remote control does not work	<ol style="list-style-type: none"> 1. Change the batteries. 2. The batteries are not installed correctly. 3. Main power is not connected.
No picture, normal sound	<ol style="list-style-type: none"> 1. Adjust the brightness and contrast. 2. Broadcasting failure may happen. 3. Tunned to UHD channel, is not supported
Normal picture, no sound	<ol style="list-style-type: none"> 1. Press the volume up button to increase the volume. 2. The volume is set to mute, press [MUTE] to restore the sound. 4. Change the sound system. 5. Broadcasting failure may happen.
Unorderly ripples on the picture	It is usually caused by local interference, such as cars, daylight lamps and hair driers. Adjust the antenna to minimize the interference.
Snowy dots, blocking and interference	<p>If the antenna is located in the fringe area of a television signal where the signal is weak, the picture may be marred by dots, show blocking or break-ups. When the signal is extremely weak, it may be necessary to install a special antenna to improve the reception.</p> <ol style="list-style-type: none"> 1. Adjust the position and orientation of the indoor/outdoor antenna. 2. Check the connection of the antenna. 3. Fine tune the channel. 4. Try another channel. Broadcasting failure may happen.
Ghost	Ghosts are caused by the television signal following two paths. One is the direct path, the other is reflected from tall buildings, hills, or other objects. Changing the direction or position of the antenna may improve the reception.

Problem	Possible cause and solution
Radio frequency interference	This interference produces moving ripples or diagonal streaks, and in some case, loss of contrast in the picture. Find out and remove the radio interference source.
Playback of video is causing picture freeze/macro blocks or similar distortion, especially on HD content	Read/write speed of your USB device could be too low. Make sure to use a USB storage device with sufficient speed and space. Pen drives (USB sticks) may not support sufficient speed.
No signal or weak signal, intermittent reception	<p>a) Cables might have loosened; moisture might have entered into cables or connectors, heavy rain at present or heavy storm at present. Check the cable connections, LNB and other equipment connected between the LNB and the receiver, or peak the dish. Wait for rain/storm to subside. Ask a local satellite specialist for advice.</p> <p>b) The satellite dish is not pointing at the (correct) satellite(s). Adjust the dish. Ask a local satellite specialist for advice.</p> <p>c) Satellite dish is too small, trees or buildings in path. Change to a larger dish or change position of dish.</p> <p>d) Signal is too strong, dish is oversized. Connect a signal attenuator to the LNB input. Ask a local satellite specialist for advice.</p>
Bad picture / blocking error during heavy rain	Heavy rain will attenuate satellite signals, below a certain level blocking will occur. Make sure your dish installation is up to standards to minimize rain effects. When in doubt, ask a local satellite specialist for advice.
If the TV turns off after plugging a cable into any connector	Again, turn on the TV.

NOTE: If the problem persists after these solutions, please contact your local support centre or send a support mail via our website www.strong.tv.

11. SPECIFICATIONS

Audio

Audio Output: 2 x 8 W

Video

Channel coverage: DVB-T/T2: 174 MHz-230 MHz; 470 MHz-860 MHz

DVB-C: 113-858 MHz

DVB-S/S2: 950 MHz-2150 MHz

System: DTV: DVB-T/T2, DVB-S/S2, DVB-C

ATV: PAL/SECAM (BG/DK/1)

AV: PAL, NTSC, SECAM

Connectors 24"

1x ANT IN

1x SAT IN

1x CI
3x HDMI
2x USB 2.0
1x LAN (RJ-45)
1x S/PDIF (coaxial)
1x HEADPHONE
1x AV IN

General Data

Operating voltage:	100 ~ 240 V AC 50/60 Hz
Power consumption:	28 W, typ. 40W
Power consumption in standby:	≤ 0.5 W
Operating temperature:	+5 °C ~ +25 °C
Storage temperature:	-15 °C ~ +45 °C
Operating humidity:	20% ~ 80% RH, non-condensing
Storage humidity:	10% ~ 90% RH, non-condensing
Dimensions (WxDxH) in mm:	550.7 x 171 x 367.3 (with stand)
Net-weight:	2.5 kg

Data Protection:

Please be aware that STRONG, its manufacturing partners, the application providers and the providers of the services may collect and use technical data and related information, including but not limited to technical information about this device, system and application software and peripherals. STRONG, its manufacturing partners, the application providers and the providers of the services may use such information to improve its products or to provide services or technologies to you, as long as it is in a form that does not personally identify you.

Additionally, please keep in mind that some services provided - already in the device or installed by you - may request a registration for which you have to provide personal data.

Besides that, please be aware that some services which are not pre-installed but can be installed may collect personal data even without providing additional warnings and that STRONG cannot be held liable for a possible breach of data protection by services not pre-installed.