

U TYPE

REV.	DESCRIPTION	DRAWN	CHECKED	APPROVED
A	NEW RELEASE	LJH 09/15/05'	~	LJC 09/15/05'
B,C,D	ADD DIM.	LJH 04/04/06'	~	LJC 04/04/06'
F	ADD DIM.	LJH 04/15/06'	~	LJC 04/04/06'
G	整理图面	YCH 03/15/07'	~	LJC 03/15/07'
K	整理图面	YCH 08/12/09'	~	LJC 08/12/09'
L	ADD P/N CODE	LJC 12/08/13'		

NOTES:

1. MATERIALS

- 1.1 CONTACT MATERIAL: COPPER ALLOY.
- 1.2 INSULATOR: PBT WITH GLASS FIBER.

2. SPECIFICATIONS

- 2.1 CURRENT RATING: 3A.
- 2.2 OPERATING TEMPERATURE: -40°C TO +105°C.
- 2.3 INSULATION RESISTANCE: 1000MΩ MIN.
- 2.4 CONTACT RESISTANCE: 20mΩ MAX.
- 2.5 DIELECTRIC WITHSTANDING: 600 VAC.

3. PRODUCT NUMBER CODE:

DS1022- X X U X X - X

PLATING LEVEL(FOR GOLD ONLY)Ⓧ
 3A: 0.8-1.2u" B: LEVEL B
 N: LEVEL N

Dim. A B C type
 1: Type 1
 2: Type 2

CONTACT PLATING
 F1: FULL GOLD FLASH
 6: FULL TIN

BEND TYPE
 U: U TYPE

MOUNTING TYPE
 R: R/A

No.OF CONTACTS
 1*1 - 1*40

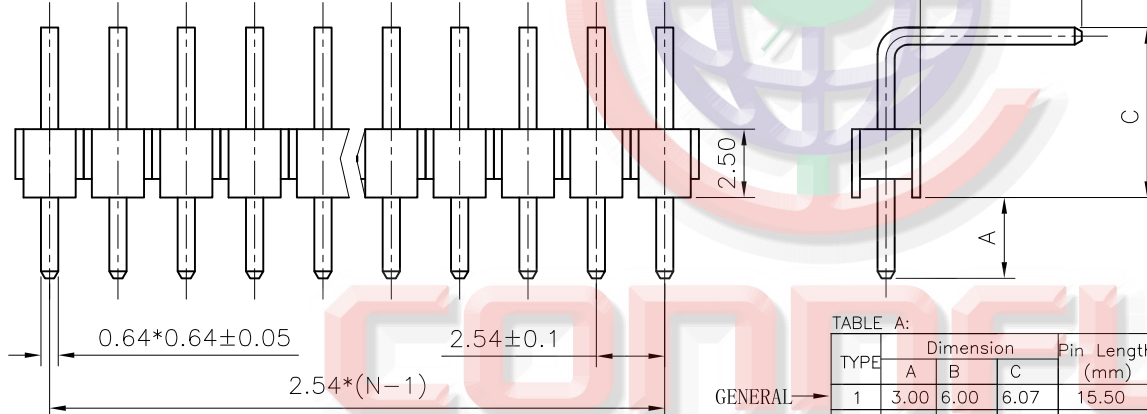

TABLE A:

TYPE	Dimension			Pin Length (mm)
	A	B	C	
1	3.00	6.00	6.07	15.50
2	4.00	6.90	3.40	14.70
3	6.00	11.40	5.64	23.40
4	3.75	3.40	3.40	11.00
5	2.80	4.00	3.40	10.60
6	5.85	7.90	3.40	17.50
7	3.60	3.20	3.40	10.60
8	6.30	3.20	4.36	14.20
9	3.00	6.00	5.42	15.00
10	3.64	5.76	6.48	16.30
11	3.00	6.00	5.00	14.40
12	3.10	3.40	3.40	10.50
13	6.00	4.90	3.40	14.70
14	6.30	3.00	3.40	13.10
15	6.20	3.70	3.60	14.00
16	3.00	6.30	4.20	14.00
17	2.30	5.11	5.30	13.10
18	6.20	3.80	3.40	13.80
19	4.70	4.70	4.20	14.00
20	4.00	6.93	5.50	16.85
21	2.50	5.40	4.50	12.80
22	5.10	3.50	4.00	13.10

23	3.00	4.40	4.00	11.85
24	3.00	4.75	4.00	12.15
25	4.70	4.80	3.70	13.70
26	3.00	12.50	5.00	20.95
27	5.80	4.30	3.34	13.85
28	2.50	5.20	4.30	12.40
29	3.00	6.20	6.45	16.10
30	3.00	6.00	4.30	13.80
31	7.50	7.80	4.00	19.80
32	3.00	7.00	6.07	15.50
33	3.00	6.00	6.57	16.00
34	6.00	4.40	3.68	14.50
35	3.07	5.92	6.50	15.90
36	3.30	3.15	5.10	12.00
37	3.00	6.50	4.50	14.40
38	3.00	6.50	5.07	15.00
39	6.00	2.40	4.20	13.00
40	6.10	3.20	4.36	14.10
41	4.20	4.20	4.20	13.00
42	2.60	11.00	8.20	22.20
43	3.00	6.00	4.00	13.40
44	5.72	5.10	4.26	15.50
45	3.00	3.00	4.00	10.50
46	3.00	5.80	6.50	15.80

47	3.30	5.80	4.36	14.00
48	3.50	6.32	5.50	15.70
49	4.00	7.90	3.30	15.70
50	3.50	2.20	4.30	10.50
51	3.00	3.00	4.30	10.80
52	3.00	5.20	3.80	12.50

N: NUMBER OF CONTACTS
 2.54*N REF

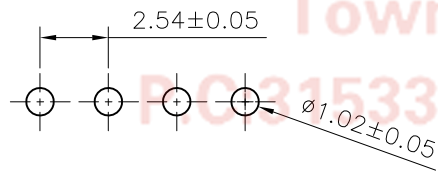
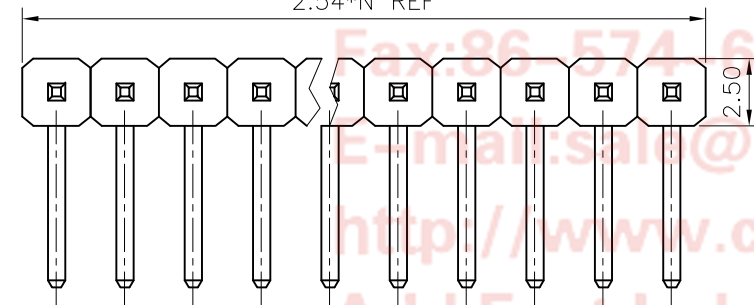

RECOMMEND P.C.BOARD LAYOUT

A/B/C: CUSTOMER LENGTH AVAILABLE

GENERAL TOLERANCE		ANGLE TOLERANCE	
X.	±0.60	X.	±5°
.X	±0.38	.X	±3°
.XX	±0.25	.XX	±2°

PROJECTION	TITLE
UNITS	2.54mm PIN HEADER R/A TYPE SINGLE ROW U TYPE
SHEET SIZE	A4
SERIES	DS1022 SERIES

DRAWING TYPE	CUSTOMER
SCALE	1:1 SHEET 1 OF 1
DRAWING NO.	C-DS1022-1*XXUXX-X-L

晨翔电子有限公司
CONNFLY® CONNFLY ELECTRONIC CO., LTD

D TYPE

REV.	DESCRIPTION	DRAWN	CHECKED	APPROVED
A	NEW RELEASE	LJH 04/06/06'	~	LJC 04/06/06'
B	ADD DIM	LL 08/05/06'	~	LJC 04/06/06'
C	增加规格整理图面	YCH 03/15/07'	~	LJC 03/15/07'
J	整理料号	YCH 04/23/08'	~	
K	ADD P/N CODE	LJC 12/08/13'		

- NOTES:
- MATERIALS
 - 1.1 CONTACT MATERIAL: COPPER ALLOY.
 - 1.2 INSULATOR: PBT WITH GLASS FIBER.
 - SPECIFICATIONS
 - 2.1 CURRENT RATING: 3A.
 - 2.2 OPERATING TEMPERATURE: -40°C TO +105°C.
 - 2.3 INSULATION RESISTANCE: 1000MΩ MIN.
 - 2.4 CONTACT RESISTANCE: 20mΩ MAX.
 - 2.5 DIELECTRIC WITHSTANDING: 600 VAC.
 - PRODUCT NUMBER CODE:

DS1022- X X U X X - X

 - PLATING LEVEL(FOR GOLD ONLY)Ⓛ
 - 3A: 0.8-1.2u" B: LEVEL B
 - N: LEVEL N

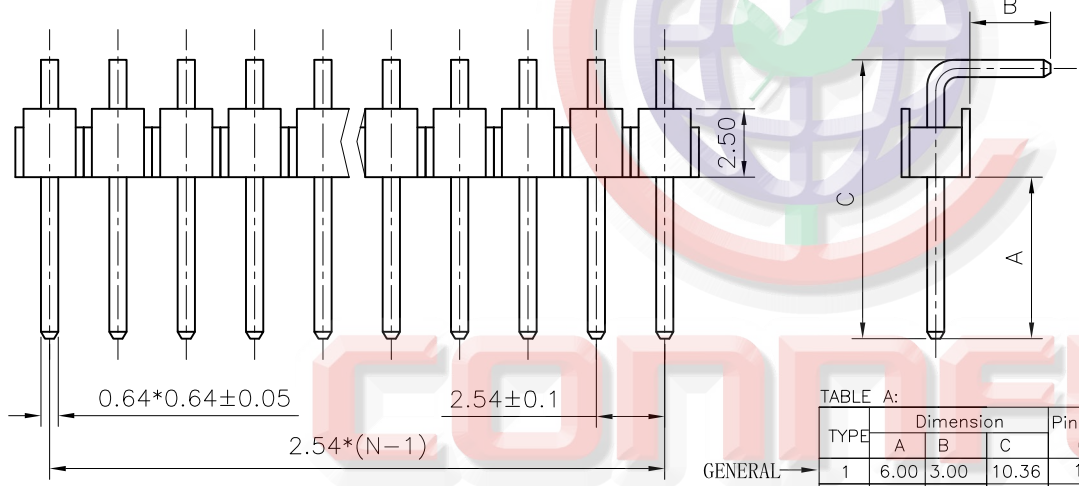
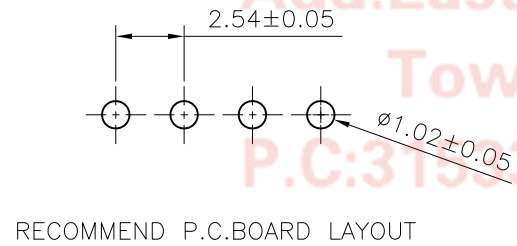
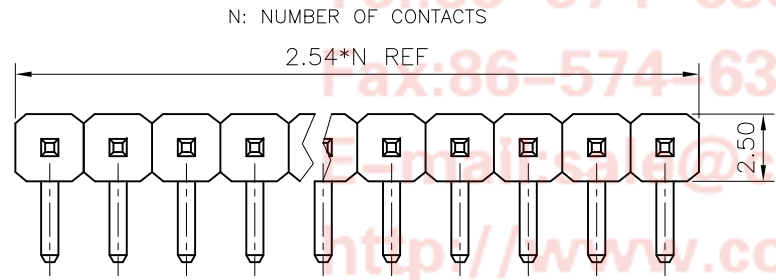

TABLE A:

TYPE	Dimension			Pin Length (mm)	21	5.00	2.70	8.14	11.30
	A	B	C						
1	6.00	3.00	10.36	13.80	22	8.20	2.80	12.30	15.50
2	6.00	4.50	9.50	14.40	23	3.00	3.00	7.36	10.80
3	6.10	4.00	10.40	14.80	24	6.50	3.00	10.36	13.80
4	6.00	3.20	10.50	14.10	25	6.80	8.40	10.64	19.50
5	6.00	3.50	10.82	14.70	26	10.00	3.20	14.40	18.00
6	4.70	1.73	8.20	10.40	27	3.50	2.50	7.82	10.80
7	15.00	3.00	19.08	22.50	28	6.00	3.00	9.50	12.90
8	6.00	3.10	11.10	14.40	29	7.00	3.10	13.90	17.50
9	1.00	1.91	5.00	7.40	30	4.00	3.00	8.36	11.80
10	6.20	3.20	11.10	14.70	31	3.00	5.40	8.65	14.50
11	6.20	3.20	10.8	14.40	32	4.50	4.50	8.82	17.80
12	4.50	2.93	8.00	11.40	33	3.20	6.00	7.50	14.00
13	6.30	2.60	10.36	13.40	34	3.80	6.00	8.30	14.80
14	5.70	2.95	9.52	12.90	35	3.00	3.40	8.00	11.80
15	4.80	3.00	8.10	11.50	36	3.80	3.00	7.93	11.20
16	6.00	3.00	9.14	12.60	37	16.4	13.00	19.60	33.00
17	7.20	3.00	10.36	13.80	38	6.85	3.00	10.90	14.30
18	3.00	6.00	7.50	13.80	39				
19	3.00	6.00	9.32	15.80	40				
20	3.50	3.00	7.86	11.30	41				
					42				



A/B/C: CUSTOMER LENGTH AVAILABLE

GENERAL TOLERANCE		ANGLE TOLERANCE	
X.	±0.60	X.	±5°
.X	±0.38	.X	±3°
.XX	±0.25	.XX	±2°

PROJECTION	TITLE
UNITS	2.54mm PIN HEADER R/A TYPE
SHEET SIZE	SINGLE ROW D TYPE
	SERIES DS1022 SERIES

DRAWING TYPE	CUSTOMER
SCALE	1:1 SHEET 1 OF 1
DRAWING NO.	C-DS1022-1*XXDX-X-K

晨翔电子有限公司
CONNFLY® CONNFLY ELECTRONIC CO., LTD

REV.	DESCRIPTION	DRAWN	CHECKED	APPROVED
A	NEW RELEASE	LJH 09/21/05'	~	LJC 09/21/05'
B,C	ADD DIM.	LJH 04/04/06'	~	LJC 04/04/06'
D	ADD DIM.	LL 09/26/06'	~	LJC 09/26/06'
E	整理图面	YCH 03/15/07'	~	LJC 03/15/07'
F	增加SMT尺寸值表格	YCH 05/18/07'	~	LJC 05/18/07'
G	整理图面	YCH 07/23/08'	~	LJC 07/23/08'
H	去除SMT类型	YCH 05/28/09'	~	LJC 05/28/09'
J	ADD P/N CODE	JLZ 07/23/14'	~	

RIGHT ANGLE TYPE
N:NUMBER OF CONTACT/2

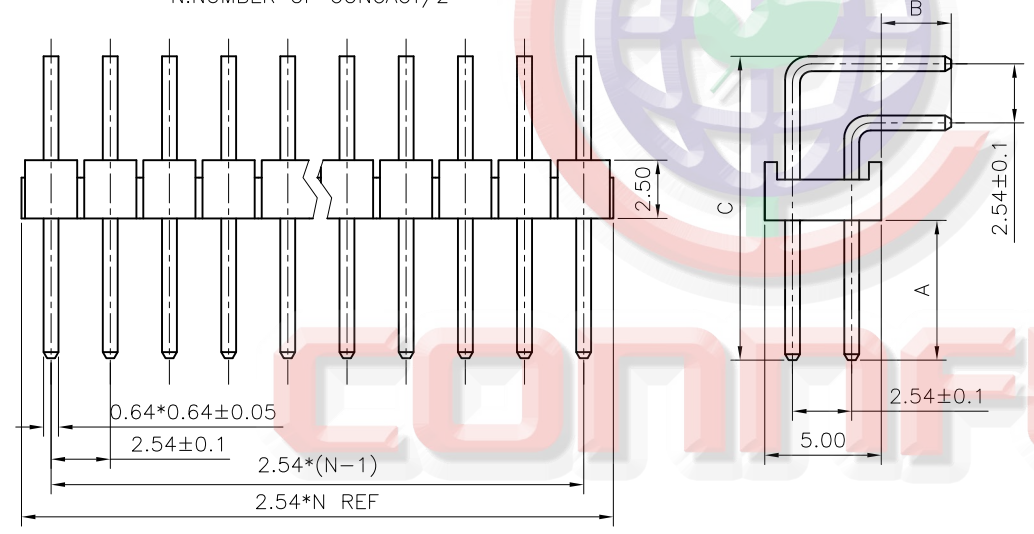

NOTES:

- MATERIALS
 - CONTACT MATERIAL: COPPER ALLOY.
 - INSULATOR: PBT WITH GLASS FIBER.
- SPECIFICATIONS
 - CURRENT RATING: 3A.
 - OPERATING TEMPERATURE: -40°C TO $+105^{\circ}\text{C}$.
 - INSULATION RESISTANCE: 1000M Ω MIN.
 - CONTACT RESISTANCE: 20m Ω MAX.
 - DIELECTRIC WITHSTANDING: 600 VAC.
- PRODUCT NUMBER CODE:
 DS1022- X X X X - X
 ① PLATING LEVEL(FOR GOLD ONLY)
 3A: 0.8-1.2 μ " B: LEVEL B
 N: LEVEL N

RIGHT ANGLE /弯针
TABLE A:

TYPE	Dimension			Pin Length 针长 (mm)
	A	B	C	
1	6.00	3.00	13.04	14.00 19.00
2	6.10	4.00	12.94	14.80 19.90
3	6.00	4.00	12.76	14.70 19.70
4	9.00	3.00	16.04	16.90 22.00
5	6.00	3.00	13.80	14.70 19.80
6	5.10	3.00	13.04	14.00 19.00
7	6.50	3.00	13.10	14.00 19.00
8	3.00	6.00	9.32	18.30 13.20
9	3.00	3.00	10.90	11.90 16.90
10	7.00	3.10	13.90	14.90 20.00
11	4.00	3.00	10.76	11.70 16.70

TYPE	Dimension			Pin Length 针长 (mm)
	A	B	C	
12	3.00	3.00	9.90	10.90 15.90
13	6.00	3.50	13.04	14.40 19.50
14	3.00	9.00	11.90	18.80 23.90
15				
16				
17				
18				
19				
20				
21				
22				

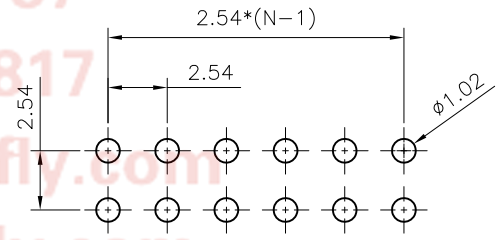

- Dim. A B C type
 - Type 1
 - Type 2
 - Type 3
 - Type 4
 - Type 5
 - Type 6
 - Type 7
 - Type 8
- CONTACT PLATING
 - FULL GOLD FLASH
 - FULL TIN
- MOUNTING TYPE
 - R/A
- No. OF CONTACTS
 - 2*1 - 2*40

GENERAL TOLERANCE	ANGLE TOLERANCE	PROJECTION	TITLE
X. ± 0.60	X. $\pm 5'$		2.54mm PIN HEADER R/A TYPE
.X ± 0.38	.X $\pm 3'$	UNITS	mm
.XX ± 0.25	.XX $\pm 2'$	SHEET SIZE	A4
DRAWING TYPE	CUSTOMER	SERIES	DS1022 SERIES
SCALE	1:1	SHEET	1 OF 1
DRAWING NO.	C-DS1022-2*XXX-X-J	晨翔电子有限公司 CONNFLY® CONNFLY ELECTRONIC CO., LTD	

RIGHT ANGLE TYPE
N:Total Positions/3

REV.	DESCRIPTION	DRAWN	CHECKED	APPROVED
A	NEW RELEASE	LJC 09/13/13'	/	LJC 09/13/13'
B	ADD P/N CODE	LJC 12/08/13'		

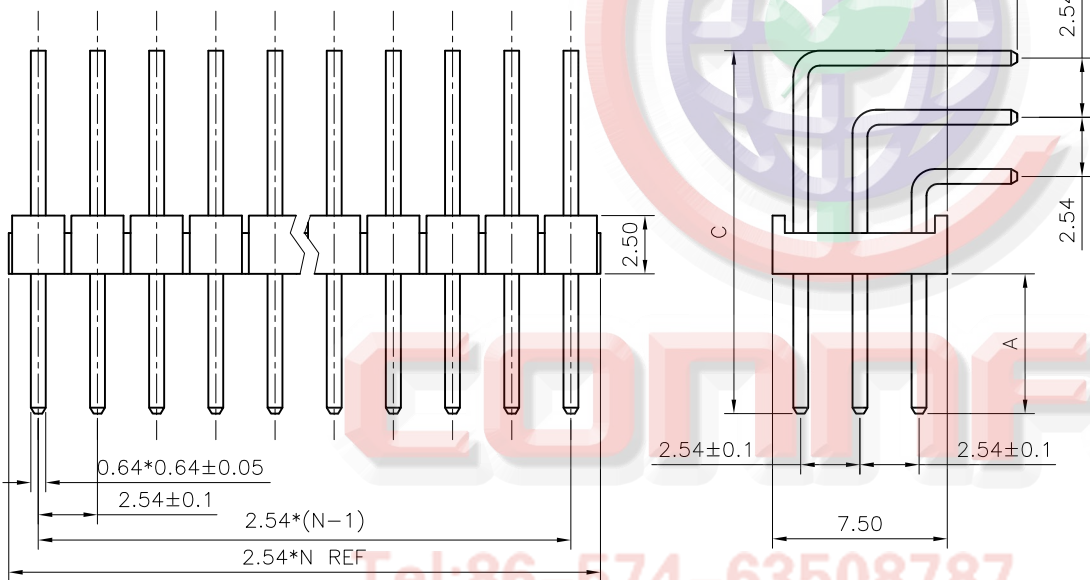

NOTES:

- MATERIALS**
 - CONTACT MATERIAL: COPPER ALLOY.
 - INSULATOR: PBT WITH GLASS FIBER.
- SPECIFICATIONS**
 - CURRENT RATING: 3A.
 - OPERATING TEMPERATURE: -40°C TO +105°C.
 - INSULATION RESISTANCE: 1000MΩ MIN.
 - CONTACT RESISTANCE: 20mΩ MAX.
 - DIELECTRIC WITHSTANDING: 600 VAC.
- PRODUCT NUMBER CODE:**
DS1022- X X X X - X
 - PLATING LEVEL(FOR GOLD ONLY)Ⓑ
3A: 0.8-1.2u" B: LEVEL B
 - Dim. A B C type
1: Type 1
.....
 - CONTACT PLATING
F1: FULL GOLD FLASH
6: FULL TIN
 - MOUNTING TYPE
R: R/A
 - No.OF CONTACTS
3*1 - 3*40

TABLE A:

TYPE	Dimension			Pin Length (mm)
	A	B	C	
1	6.00	3.00	15.58	Short: 14.0 Middle: 19.0 Long: 24.0

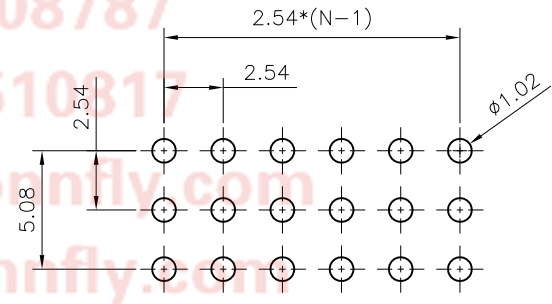

Tel:86-574-63508787
 Fax:86-574-63510317
 E-mail:sale@connfly.com
<http://www.connfly.com>
 Add:East Industry Zone, KuangYan
 Town Cixi Ningbo China
 P.C:315333

GENERAL TOLERANCE		ANGLE TOLERANCE		PROJECTION	TITLE	2.54mm PIN HEADER R/A TYPE	
X.	±0.60	X.	±5'	mm		3 ROWS	
.X	±0.38	.X	±3'	A4	SHEET SIZE	SERIES DS1022 SERIES	
.XX	±0.25	.XX	±2'	晨翔电子有限公司 CONNFLY® CONNFLY ELECTRONIC CO., LTD			
DRAWING TYPE		CUSTOMER					
SCALE	1:1	SHEET	1 OF 1				
DRAWING NO.		C-DS1022-3*XXX-X-B					

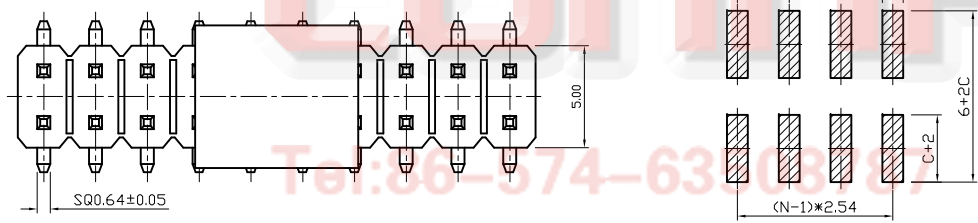
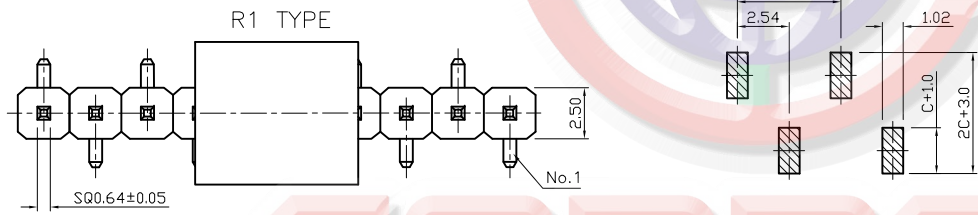
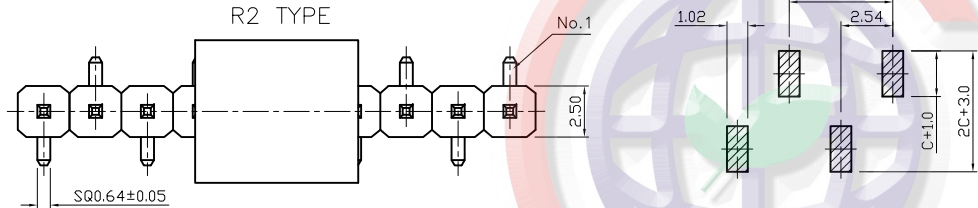

RECOMMEND PCB LAYOUT
TOLERANCE=±0.05

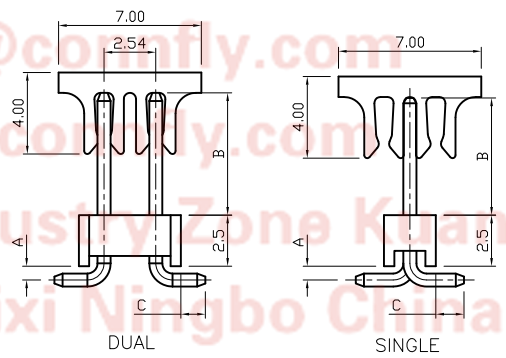
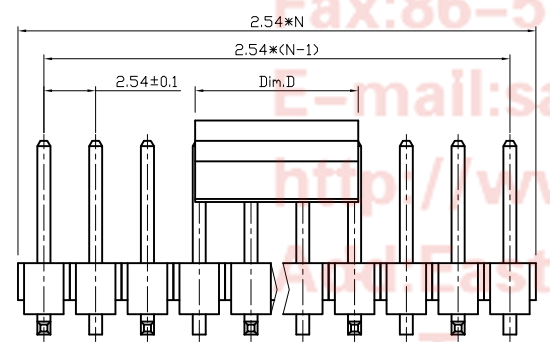

pos.	Dim.	Dim.D
2~8pin		5.0mm
9~40pin		8.0mm

REV.	DESCRIPTION	DRAWN	CHECKED	APPROVED
A	NEW RELEASE	YCH 11/19/10'	~	LJC 11/19/10'
B	ADD P/N CODE	LJC 12/08/13'	~	LJC 12/08/13'
C	吸嘴修改	YCH 04/23/14'	~	

TABLE B:

TYPE	Dimension			Pin Length (mm)
	A	B	C	
1	1.50	6.00	3.00	13.80
2	1.20	6.00	3.00	13.50
3	0.68	7.75	1.20	12.90
4	1.20	8.00	2.50	14.90
5	1.20	6.00	1.20	11.70
6	0.70	6.00	1.40	11.30
7	1.50	6.00	1.20	11.90
8	1.00	5.84	1.40	11.60
9	1.00	8.13	1.40	13.80
10	1.18	11.00	2.50	17.90
11	0.68	4.50	1.40	10.00
12				
13				
14				
15				
16				
17				
18				
19				
20				
21				
22				
23				
24				
25				

NOTES:

- MATERIALS
 - 1.1 CONTACT MATERIAL: COPPER ALLOY.
 - 1.2 CONTACT PLATING: FULL GOLD OR TIN OVER NICKEL.
 - 1.3 INSULATOR MATERIALS: HIGH TEMP. UL94 V-0,COLOR OF BLACK.
- SPECIFICATIONS
 - 2.1 CURRENT RATING: 3A.
 - 2.2 OPERATING TEMPERATURE: -40°C TO +105°C.
 - 2.3 INSULATION RESISTANCE: 1000MΩ MIN.
 - 2.4 CONTACT RESISTANCE: 20mΩ MAX.
 - 2.5 DIELECTRIC WITHSTANDING : 600 VAC.
- PRODUCT NUMBER CODE:

DS1022- X X M X X X X - X

 - Ⓧ PLATING LEVEL(FOR GOLD ONLY)
3A: 0.8-1.2u" B: LEVEL B
 - PICK UP SUPPORT
S: W/ PICK UP
X: W/O PICK UP
 - Dim. A B C type
1: Type 1
2: Type 2
.....
 - CONTACT PLATING
F1: FULL GOLD FLASH
6: FULL TIN
 - BEND TYPE (SINGLE ROW ONLY)
A: R1 TYPE
B: R2 TYPE
 - MOUNTING TYPE
M: SMT
 - No.OF CONTACTS
1*2 - 1*40
2*2 - 2*40

GENERAL TOLERANCE		ANGLE TOLERANCE	
X.	±0.60	X.	±5°
.X	±0.38	.X	±3°
.XX	±0.25	.XX	±2°

PROJECTION	TITLE
UNITS	PIN HEADER PITCH 2.54mm SMT TYPE
SHEET SIZE	SERIES DS1022 SERIES

DRAWING TYPE	CUSTOMER
SCALE	1:1 SHEET 1 OF 1
DRAWING NO.	C-DS1022-XMXXXXXX-X-C

晨翔电子有限公司
CONNFly® CONNFly ELECTRONIC CO., LTD