

REV.	DESCRIPTION	DRAWN	CHECKED	APPROVED
A	NEW RELEASE	LJH 09/20/05'	~	LJC 09/20/05'
B	料号中增加尺寸DIM.H,E选项	YCH 07/18/08'	~	LJC 07/18/08'
C	ADD P/N CODE	YCH 12/02/13'	~	LJC 12/02/13'
D	ADD P/N CODE	JLZ 07/25/14'	~	

NOTES:

1. ELECTRICAL CHARACTERISTICS:

- 1.1 CONTACT RESISTANCE: 20mΩ Max. INITIAL.
- 1.2 DIELECTRIC WITHSTANDING VOLTAGE: 500V AC(rms) FOR 1 MINUTE.
- 1.3 INSULATION RESISTANCE: 1000MΩ Min.

2. ENVIRONMENT CHARACTERISTICS:

TEMPERATURE RANGE: -40°C~+105°C.

3. PRODUCT NUMBER CODE:

DS1013- X X X X X X - X - X

HOUSING MATERIAL
 0: PBT UL94 V-0
 2: PBT UL94 HB
 4: PA-46

PLATING LEVEL(FOR GOLD ONLY) ©
 3A: 0.8-1.2u"
 B: LEVEL B
 N: LEVEL N

DIM. H TYPE (FOR ELEVATOR ONLY)
 1: 7.50
 2: 9.50

DIM. E TYPE (FOR V/T ONLY)
 1: 3.10
 2: 8.00

HOUSING COLOR
 B: BLACK
 W: WHITE
 U: BLUE
 A: GRAY

CONTACT PLATING
 Si: FULL GOLD FLASH

MOUNTING TYPE
 S: V/T TYPE
 R: R/A TYPE
 E: Elevator TYPE

No.OF CONTACTS
 06 08 10 14 16 20 24
 26 30 34 40 50 60 64

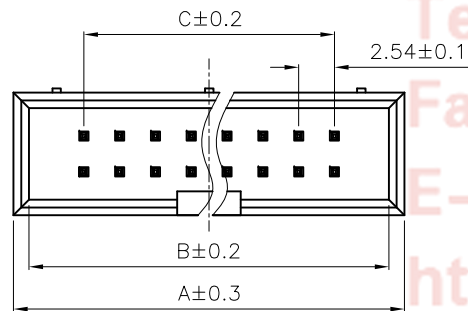
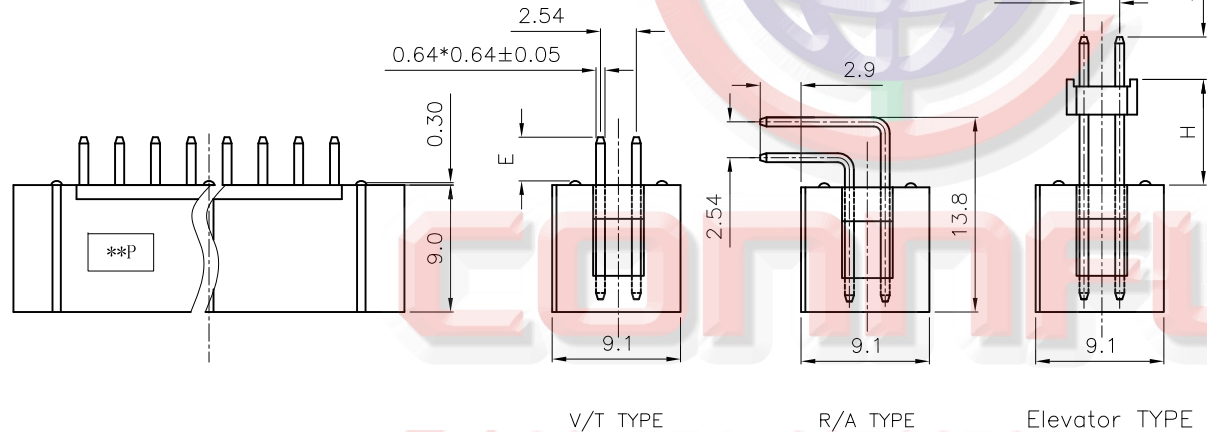
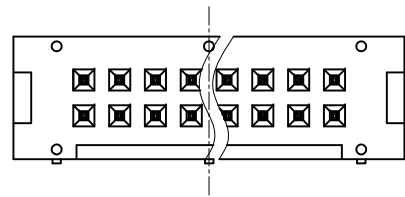

Dimension

Position	A	B	C				
⑥ 06	15.22	13.02	5.08				
⑧ 08	17.76	15.56	7.62				
10	20.30	18.10	10.16	30	45.70	43.50	35.56
12	22.84	20.64	12.70	34	50.78	48.58	40.64
14	25.38	23.18	15.24	40	58.40	56.20	48.26
16	27.92	25.72	17.78	50	71.10	68.90	60.96
20	33.00	30.80	22.86	60	83.80	81.60	73.66
26	40.62	38.42	30.48	64	88.88	86.68	78.74

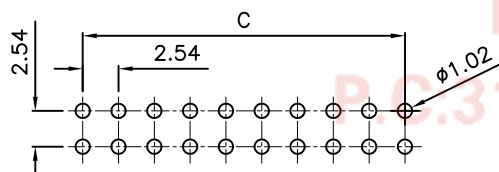

RECOMMEND PCB LAYOUT(TOLERANCE=±0.05)

GENERAL TOLERANCE		ANGLE TOLERANCE	
X.	±0.60	X.	±5°
.X	±0.38	.X	±3°
.XX	±0.25	.XX	±2°

PROJECTION	TITLE	2.54mm BOX HEADER	
UNITS	mm	R/A, V/T & ELEVATOR TYPE	
SHEET SIZE	A4	SERIES	DS1013 SERIES

DRAWING TYPE	CUSTOMER		
SCALE	1:1	SHEET	1 OF 1
DRAWING NO.	C-DS1013-XXXX-X-X-D		



CONNFLY®

晨翔电子有限公司

CONNFLY ELECTRONIC CO., LTD

REV.	DESCRIPTION	DRAWN	CHECKED	APPROVED
A	NEW RELEASE	LJH 09/20/05'	~	YCH 09/20/05'
B	ADD P/N CODE	YCH 12/02/13'	~	

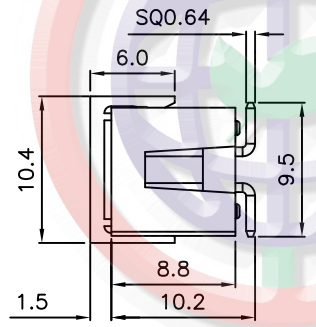
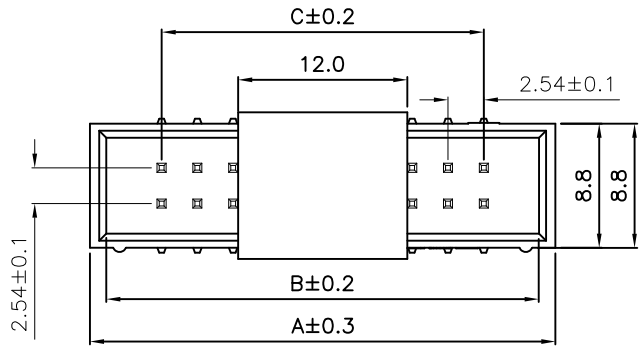

Dimension

Position	A	B	C
10	20.30	18.10	10.16
12	22.84	20.64	12.70
14	25.38	23.18	15.24
16	27.92	25.72	17.78
20	33.00	30.80	22.86
26	40.62	38.42	30.48
30	45.70	43.50	35.56
34	50.78	48.58	40.64
40	58.40	56.20	48.26
50	71.10	68.90	60.96
60	83.80	81.60	73.66
64	88.88	86.68	78.74

NOTES:

- ELECTRICAL CHARACTERISTICS:
 - CONTACT RESISTANCE: 20mΩ Max. INITIAL.
 - DIELECTRIC WITHSTANDING VOLTAGE: 500V AC(rms) FOR 1 MINUTE.
 - INSULATION RESISTANCE: 1000MΩ Min.
- ENVIRONMENT CHARACTERISTICS:
 - TEMPERATURE RANGE: -45°C~+105°C.

- PRODUCT NUMBER CODE: DS1013- X X X X - X
 - Ⓟ PLATING LEVEL(FOR GOLD ONLY)
 - 3A: 0.8-1.2u"
 - B: LEVEL B
 - PACKING TYPE
 - A: TUBE
 - R: TAPE ON REEL
 - T: TRAY
 - PICK UP SUPPORT
 - S: W/ PICK UP
 - X: W/O PICK UP
 - CONTACT PLATING
 - Si: FULL GOLD FLASH
 - MOUNTING TYPE
 - M: SMT TYPE
 - No.OF CONTACTS
 - 06 08 10 14 16
 - 20 26 30 34
 - 40 50 60 64
 - SERIES No. DS1013

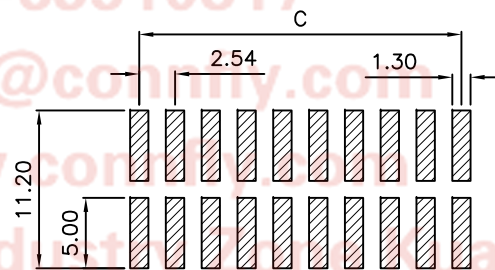
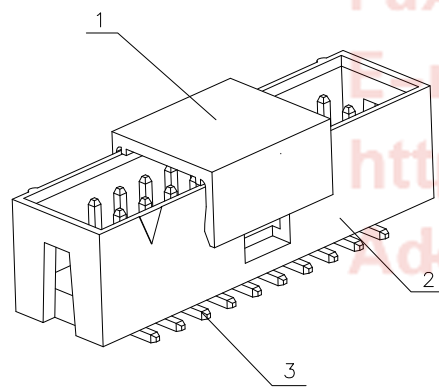
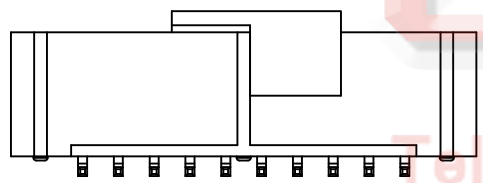

RECOMMEND PCB LAYOUT
TOLERANCE=±0.05

Tel:86-574-6350878
 Fax:86-574-63510817
 E-mail:sale@connfly.com
 http://www.connfly.com
 Add:East Industrial Zone, XiangYan
 Town Cixi Ningbo China
 P.C:315333

ITEM	PART NAME	PART NO.	MATERILAS	FINISHED	DRAWING NO.	C-DS1013-XXMXXX-X-B
3	CONTACT		COPPER ALLOY	GOLD FLASH	GENERAL TOLERANCE	ANGLE TOLERANCE
2	HOUSING		PA-9T	RoHS II & REACH,UL94 V-0	X. ±0.60	X. ±5°
1	PICK UP		PA-9T	RoHS II & REACH,UL94 V-0	.X ±0.38	.X ±3°
					.XX ±0.25	.XX ±2°

PROJECTION	TITLE	SHEET SIZE	SERIES
2.54mm BOX HEADER	2.54mm BOX HEADER	A4	DS1013 SERIES

CONNFLY 晨翔电子有限公司
CONNFLY ELECTRONIC CO., LTD