

## Data sheet for SIMOTICS S-1FK2

Article No. : 1FK2106-4AF11-0SA0



Figure similar

Client order no. :  
Order no. :  
Offer no. :  
Remarks :

Item no. :  
Consignment no. :  
Project :

### Basic motor data

Motor type	Permanent-magnet synchronous motor, Natural cooling, IP65
Motor type	High Dynamic
Static torque	12.00 Nm
Static current	10.7 A
Maximum torque	33.00 Nm
Maximum current	42.0 A
Maximum speed	6,000 rpm
Rotor moment of inertia	7.6000 kgcm <sup>2</sup>
Weight	10.6 kg

### Rated data

SINAMICS S210, 3AC 400V

Rated speed	3,000 rpm
Rated torque	8.60 Nm
Rated current	8.1 A
Rated power	2.70 kW

### Encoder system

Encoder system	Encoder AS22DQC: Absolute encoder single turn 22 bit
----------------	--

### Motor connection

Connection type	OCC for S210
Connector size	M23

### Mechanical data

Design acc. to Code I	IM B5 (IM V1, IM V3)
Vibration severity grade	Grade A
Shaft height	63
Flange size (AB)	125 mm
Centering ring (N)	110 mm
Hole circle (M)	130 mm
Screw-on hole (S)	9.0 mm
Overall length (LB)	244 mm
Diameter of shaft (D)	24 mm
Length of shaft (E)	50 mm
Length of flange diagonal (P)	158 mm
Shaft end	Plain shaft
Color of the housing	Standard (Anthracite, similar to RAL 7016)

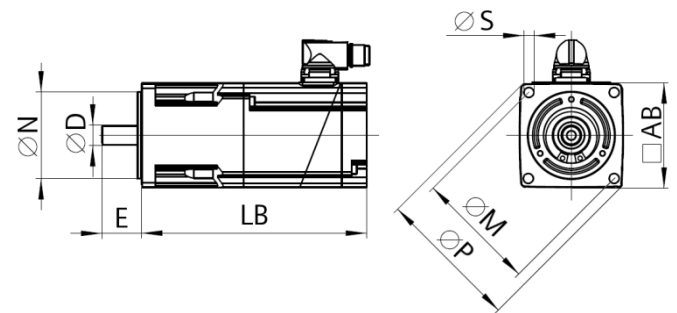

### Holding brake

Holding torque	16.00 Nm
Average dynamic torque	9.00 Nm
Opening time	70 ms
Closing time	35 ms
Maximum single switching energy <sup>1)</sup>	1,065 J
Service life, operating energy	774,000 J
Holding current <sup>2)</sup>	0.35 A
Break-induced current for 500 ms <sup>2)</sup>	1.1 A

<sup>1)</sup>Up to three consecutive emergency stops and up to 25% of all emergency stops as a Wmax high energy stop possible.

<sup>2)</sup>Typical value for 20°C ambient temperature. At -15°C the break-induced currents can be increased by up to 30%.