

***DISCOVERY***

**CH44**

**Motion Sensor Headlamp**

**Quick Start Guide**

**GP**

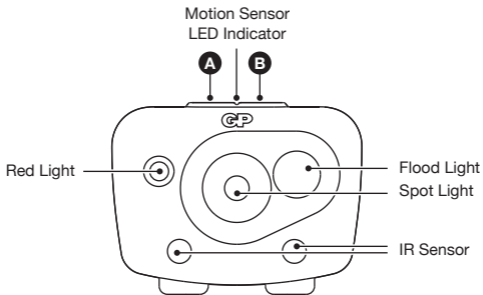

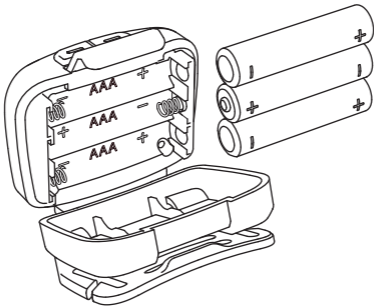

Compatible

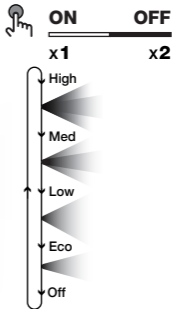
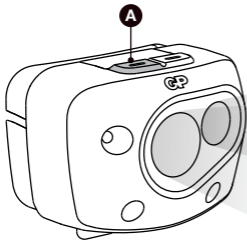

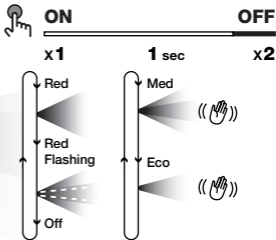
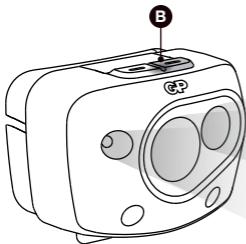

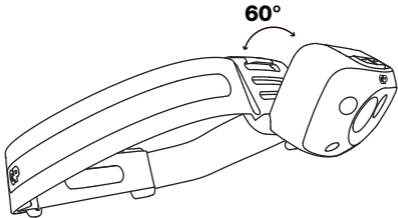

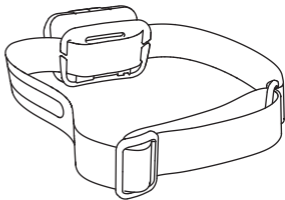
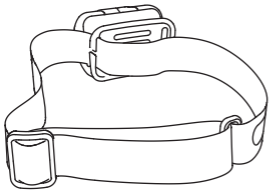



gpbatteries.com

ANSI FL1 Standard	High	Med	Low	Eco
-------------------	------	-----	-----	-----



300	175	80	35
-----	-----	----	----



60	40	30	20
----	----	----	----



4	8	16	36
---	---	----	----



IPX4



1m

CAUTION!

