



Security Tech Germany

PPIC91000 / PPIC91520



Operating instructions

You can find important information and FAQs about this and other products online at:

<https://support.abus-sc.com/>

Version 1.0



*Original operating instructions in German.
Retain for future reference.*

Introduction

Dear customer,

Thank you for purchasing this product.

ABUS Security-Center hereby declares that the base station and camera PPIC91000 and PPIC91520 comply with the RED Directive 2014/53/EU. These devices also comply with the requirements of the following EU directives: EMC Directive 2014/30/EU and RoHS Directive 2011/65/EU. The full text of the EU declaration of conformity is available at the following web addresses:

www.abus.com/product/PPIC91000
www.abus.com/product/PPIC91520

In order to maintain this condition and to ensure safe operation, you as the user must observe these operating instructions!

Please read the complete operating instructions carefully before putting the product into operation, and pay attention to all operating instructions and safety information.

All company names and product descriptions are trademarks of the corresponding owner. All rights reserved.



Data storage is subject to national data privacy guidelines.

The use of surveillance equipment may be forbidden or regulated by law in some countries. Before using this equipment, ensure that all of your surveillance activities are legal.

Note on data protection

The operator is responsible for the legally compliant use of the product in accordance with GDPR.



Warning as required by Section 201 StGB (German Criminal Code):

Whoever, without being authorised to do so, makes an audio recording of the privately spoken words of another, and uses or makes a recording thus produced available to a third party, shall incur a penalty of imprisonment or a fine.

The same penalty shall be incurred by whoever, without being authorised to do so, uses a listening device to intercept the privately spoken words of another which they are not intended to hear, or publicly communicates, verbatim or the essential content of, the privately spoken words of another which were recorded or intercepted.



Disclaimer

These operating instructions have been produced with the greatest of care. However, if you notice any omissions or inaccuracies, please let us know in writing at the above address.

ABUS Security-Center GmbH does not accept any liability for technical and typographical errors, and reserves the right to make changes to the product and user guides at any time and without prior warning.







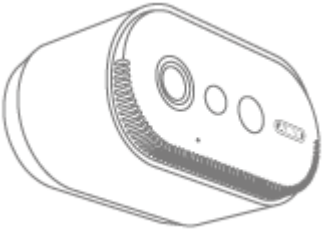

ABUS Security-Center GmbH is not liable or responsible for direct or indirect damage resulting from the equipment, performance and use of this product. No guarantee is made for the contents of this document.

Contents

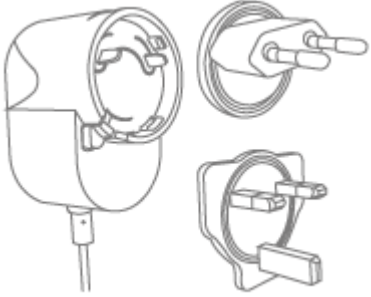
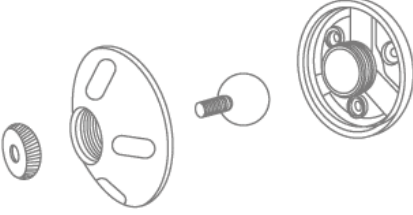
1. Scope of delivery	6
2. Description of hardware	7
2.1. Battery Camera Pro	7
2.2. Bracket	9
2.3. Base station.....	10
3. Mounting/installation	12
3.1. Camera alignment and coverage	12
3.2. Installing the camera without a wall bracket	14
3.3. Installing the camera with a wall bracket	15
3.4. Notes on the recognition of persons	16
3.5. Installing the camera and base station	18
3.6. Placement of base station without drilling.....	21
3.7. Mounting the base station on the wall.....	22
4. App2Cam Plus: First access	24
4.1. System requirements	24
4.2. Downloading the app	24
4.3. Setting up the camera	25
4.3.1. LAN setup.....	25
4.3.2. Adding a base station that has already been set up	27
4.3.3. Assigning a new camera to a base station	27
4.4. App2Cam Plus: Overview	28
4.4.1. Camera overview	29
4.4.2. Recording menu/Recordings/Storage	29
4.4.3. Info / App settings.....	30
4.5. App2Cam Plus: Live view	31
4.5.1. Live view functions	31
4.5.2. Camera indicators	32
4.5.3. Stream indicators	32
4.6. App2Cam Plus: Recordings.....	33
4.6.1. Recording menu	33
4.6.2. Recording menu functions	Fehler! Textmarke nicht definiert.
4.7. Playback.....	34
4.7.1. Playback functions	34
4.7.2. Download and share recording (download/forward)	35
4.7.3. Opening camera settings	35
4.7.4. Camera information.....	35
4.7.5. Camera settings	36
4.7.6. Base station settings	37
4.7.6.1 Security settings	37
4.7.6.2 Schedule settings	38
4.7.6.3 Storage settings.....	39
4.7.6.4 Notification settings.....	40

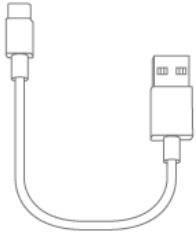
4.7.6.5	Device settings	42
4.7.6.7	Device information	43
4.7.6.8	Add camera	43
4.7.6.9	Restart base station.....	43
4.7.8.	Camera settings (camera 1-4)	44
5.	Update firmware	46
5.1.	Update via server	46
6.	Overview of voice commands	47
7.	Battery FAQs.....	48
8.	Troubleshooting tips.....	49
9.	Open Source licence notes	50

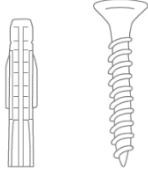
1. Scope of delivery

1		2	
3		4	
5		6	
7		8	
9		10	
11			

PPIC91000

- Battery Camera Pro (1)
- Antenna for Battery Camera Pro (2)
- Base station (3)
- Power supply unit for base station (12 V DC, 1 A) (4)
- Wall bracket (5)
- Drill template for camera (6)
- Network cable (1.5 m) (7)
- USB-A to USB-C cable (8)
- Reset tool (9)
- 2x mounting material (10)
- Drill template for base station (11)
- USB Stick (12)

PPIC91520

- Battery Camera Pro (1)
- Antenna for Battery Camera Pro (2)
- Drill template for camera (6)
- USB-A to USB-C cable (8)
- Reset tool (9)
- Mounting material (10)

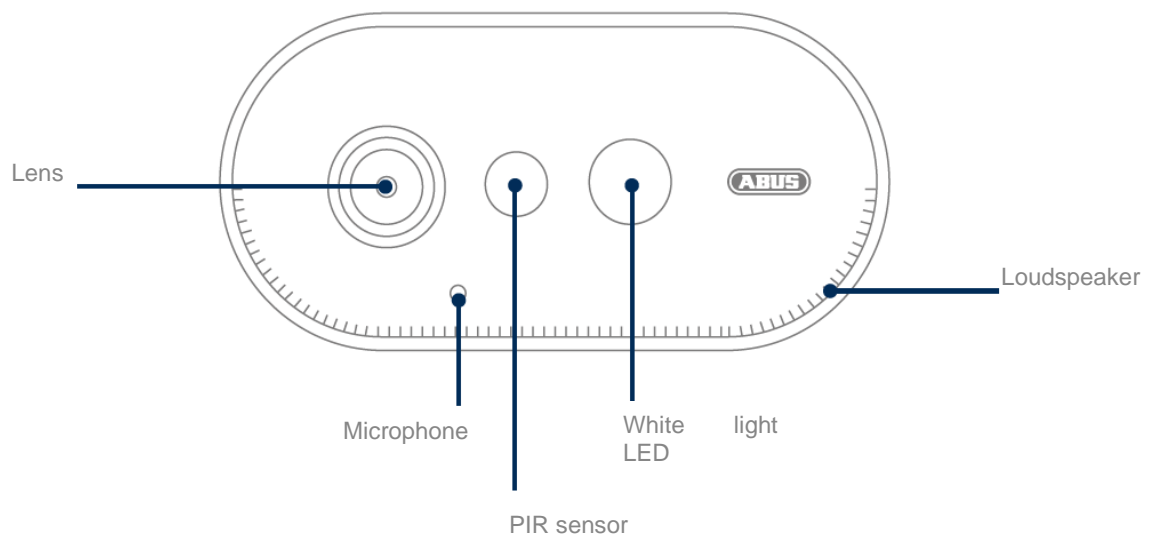
2. Description of hardware**2.1. Battery Camera Pro****Front**

Rear

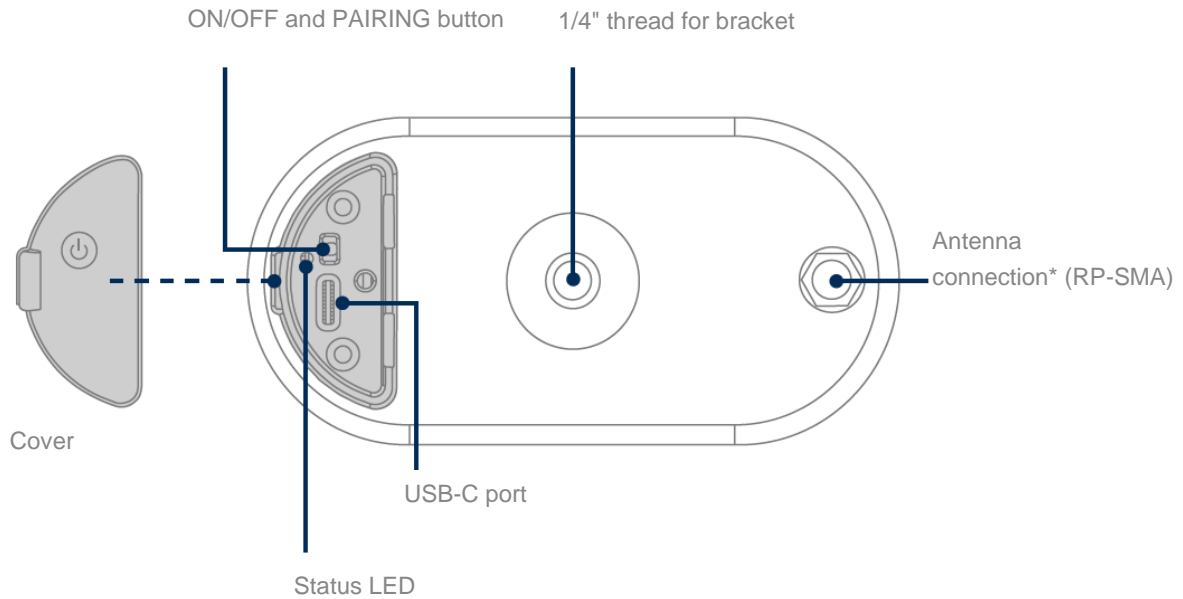

*Wireless frequency: 2.4 GHz (802.11 b/g/n), max. transmission power 20 dBm

- | | |
|---|---|
|  | <ul style="list-style-type: none"> • The charging status LED flashes during the charging process. The LED is permanently lit in red when fully charged and in wired operation, as well as during recording and access to the live view in the app. • Any bracket with 1/4" thread is supported. |
|---|---|

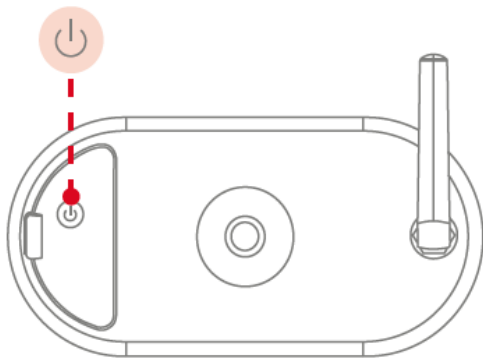

Switching on the camera:

Press and hold the On/Off button for 3 seconds until the camera issues a signal tone and the red status LED lights up.

Switching off the camera:

Press and hold the button for 5 seconds.

- | | |
|---|---|
|  | <p>Attention!</p> <p>When operating permanently with the USB-C cable, the camera can only be used indoors as protection against splashing water/rain is no longer provided with the cover open. This will invalidate the camera's ability weatherproof capability.</p> |
|---|---|

Charging the camera

The camera battery is fully charged at the factory. Due to transport and storage, the battery charge level may be reduced at the time of purchase or start-up. Tip: Fully charge the camera before using it.

Connect the enclosed USB-C cable to the corresponding port on the back of the camera. Use a commercially available mains plug (as for charging a mobile phone) with 5 V DC and 2 A to charge the camera. If the battery is empty, the camera will be fully charged again in approx. 4 hours. During charging, the red LED on the back of the camera flashes. As soon as the charging process is completed, the LED lights up red continuously. The charge status is displayed in the app within the live view during operation. The battery charge lasts up to 6 months and depends on several factors, such as triggering frequency, live image access and external environmental influences. You can find more information under menu item 7. Battery FAQs.

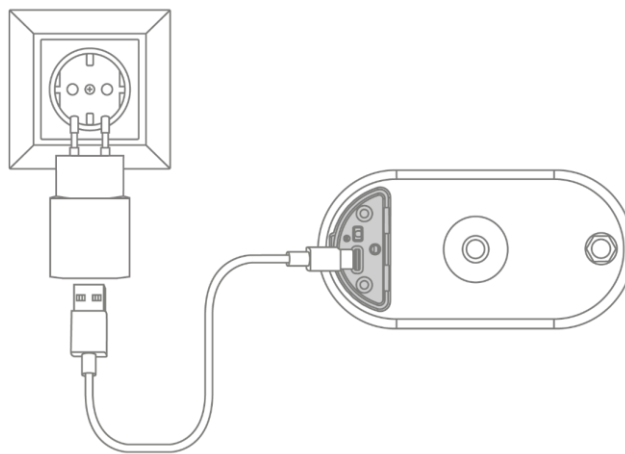

2.2. Bracket

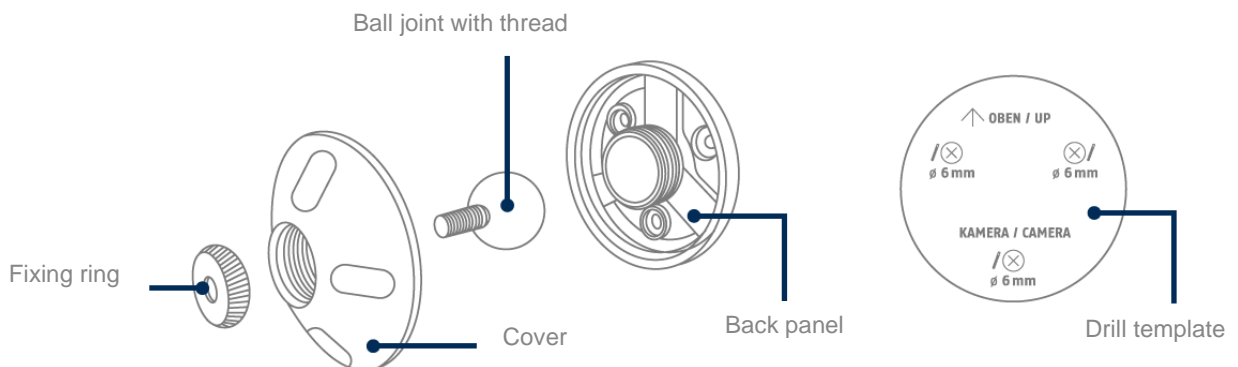

2.3. Base station

Front / Back

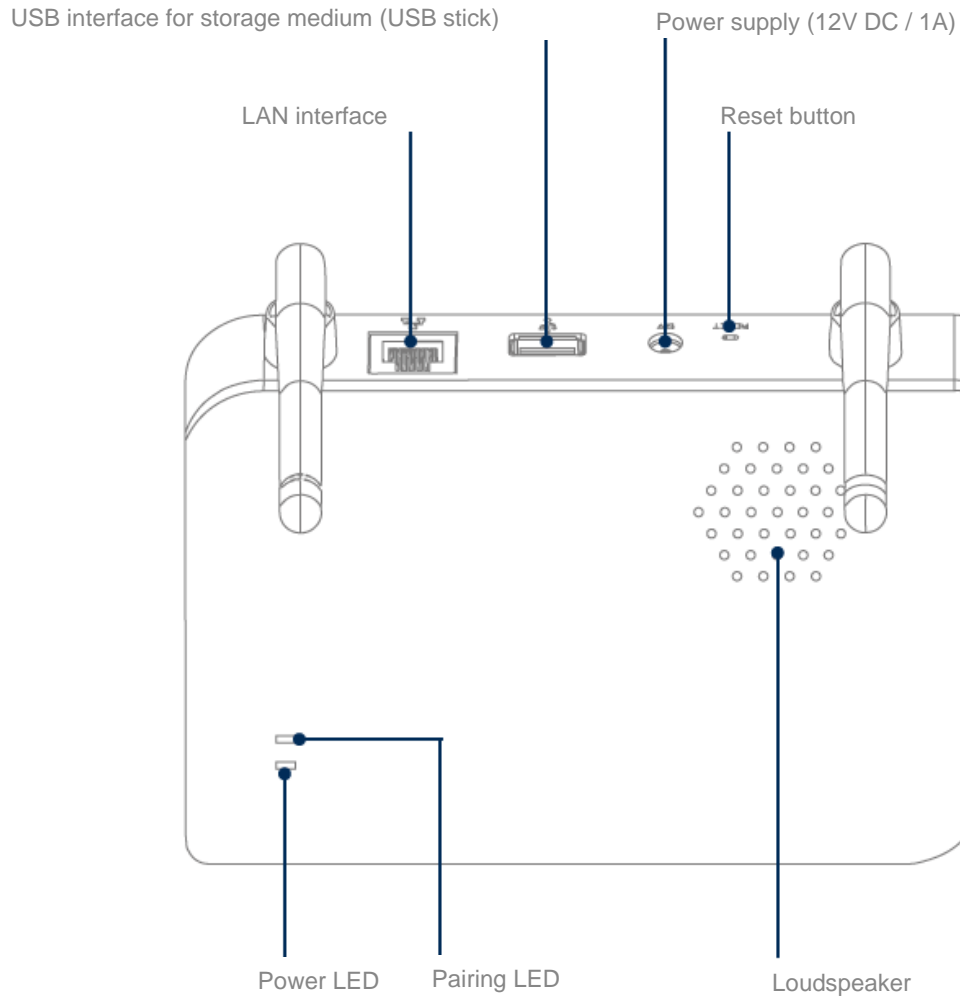

A commercially available USB stick (max. 128 GB storage capacity; not included in the scope of delivery) is required for camera recordings. If you are using a used USB stick: back up existing data if necessary and format the USB stick after start-up via the storage setting of the base station.

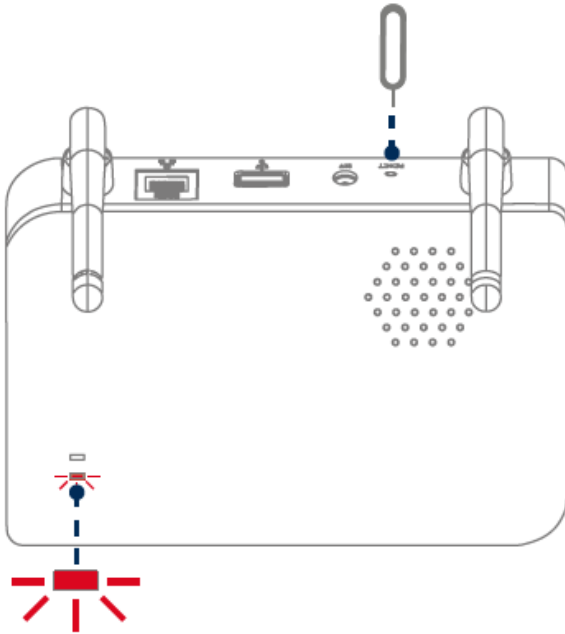

Reset to factory settings if necessary:
Press and hold the reset button with the reset tool for 5 seconds until the power LED flashes red.

LED	Status	Description
Pairing LED Power LED	Lit up blue	Base station starts
	Flashes blue	Base station is performing a camera firmware update Base station is ready to connect to another camera
	Lit up red	Base station is ready to connect to the network Base station is connected to the network
	Flashes red	The reset button was pressed on the base station, the device will be set to the factory settings.
	Off	Base station without power supply

3. Mounting/installation



ATTENTION!

The camera must be disconnected from the power supply during installation.

3.1. Camera alignment and coverage

The detection range of the integrated passive infrared motion sensor (PIR for short) is limited to 8 m. Persons who are outside this range are "seen" by the camera and displayed on the live image, but do not trigger a recording. The recommendation for optimum mounting is a mounting height of 2 m and a tilt angle of 12.5°.

Optimal alignment:

Installation height (m) and tilt angle (°)

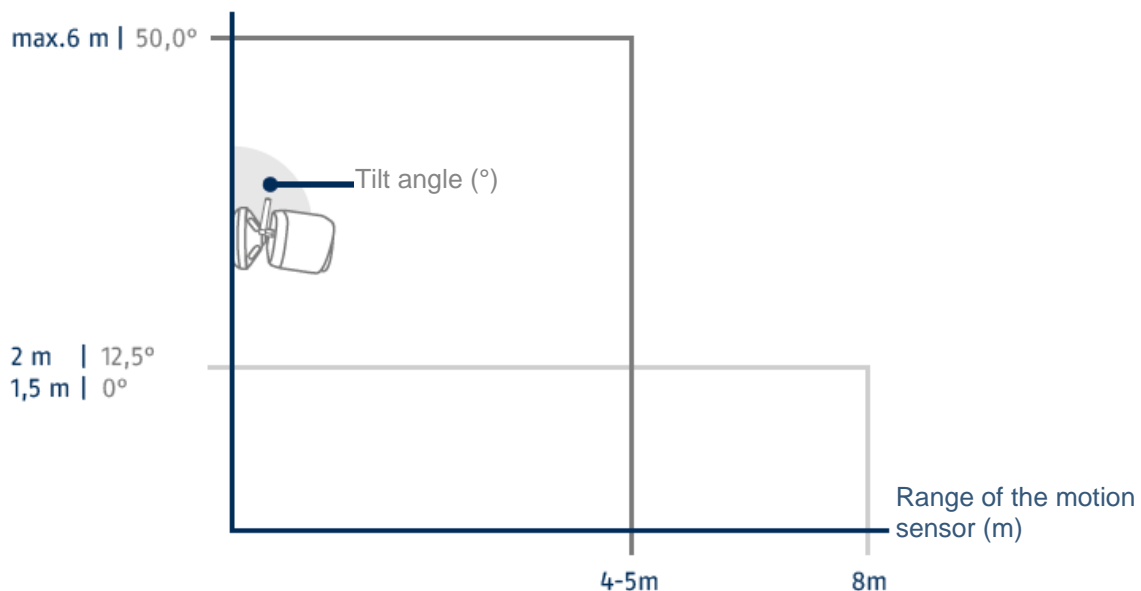

The higher the camera is installed, the greater the required downward tilt angle. This affects the range of the PIR sensor.

Installation height	Tilt angle	Max. PIR range
1.5 m	0°	8 m
2.0 m	12.5°	8 m
3.0 m	24°	7 m
4.0 m	34°	6 m
5.0 m	43°	5 m
6.0 m	50°	4–5 m

The camera's viewing angle is larger than the PIR viewing angle. When installed, it is possible that people are visible on the live image but do not trigger a recording.

This is because the person is outside the PIR detection range of 8 metres.

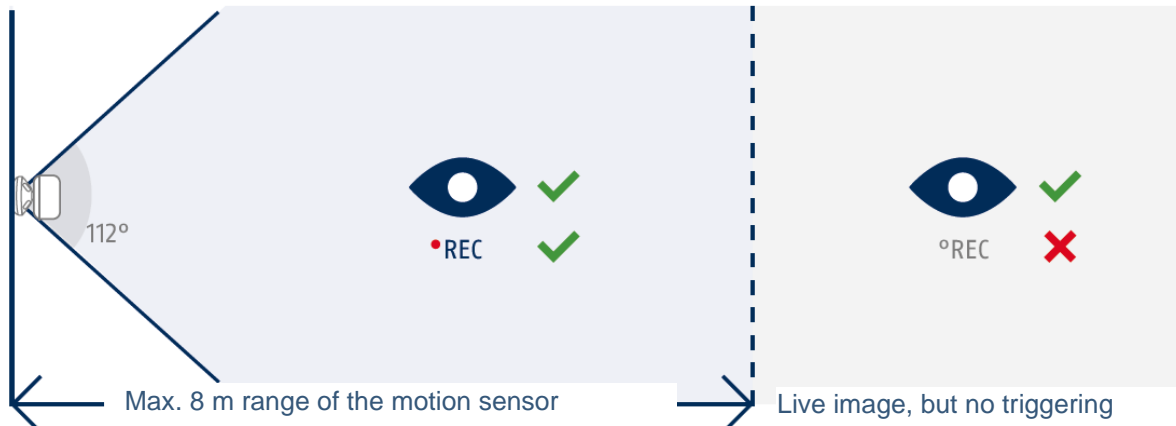

Ideal camera position for motion detection

The camera takes a short time to connect to the base station after motion detection. The movement should therefore ideally already be detected in the outer area of the PIR range in order to record the object in the video sequence for as long as possible.

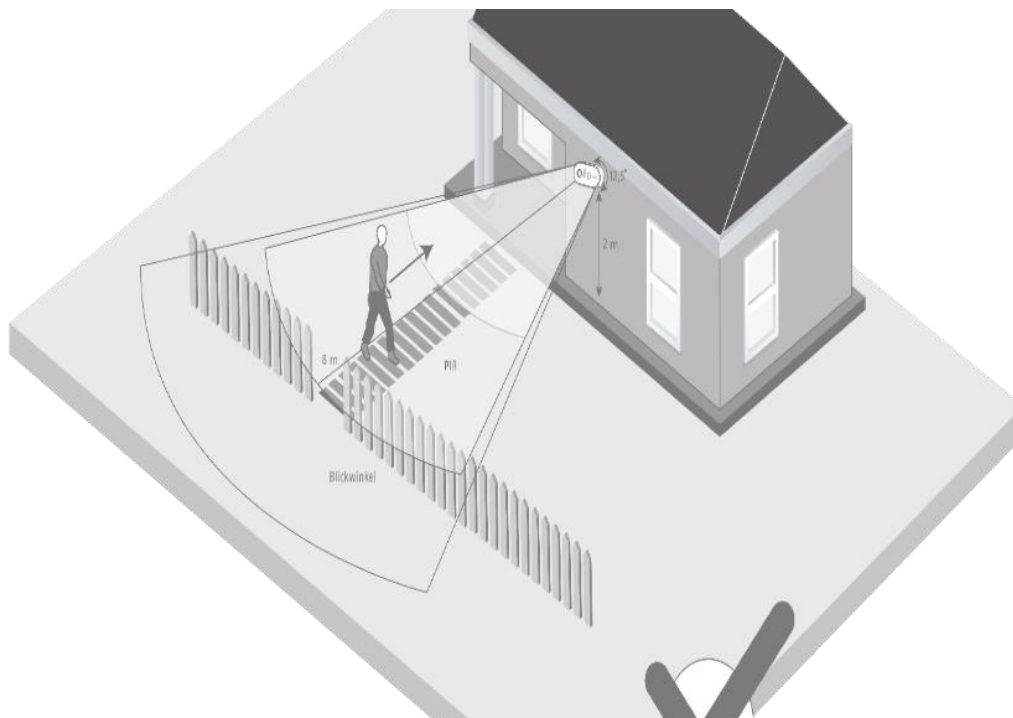

If the movement is detected very late, the object may not be completely visible on the video sequence.



Please note that detection only takes place in the specified PIR detection range. Objects that move outside the PIR range will not trigger a recording, but may be visible in the Live view of the app.

3.2. Installing the camera without a wall bracket



The camera can be placed on a flat surface without a bracket. The following points must be observed in this case:

- The position of the camera is not fixed without a bracket and can be moved unintentionally, thus changing the detection range.
- Larger objects between the camera and the base station can interfere with transmission.
- Where possible, the camera should be positioned unobstructed at the edge of the setup surface in order to prevent light reflections between the camera and the setup surface.
- The camera's field of vision must not be obstructed by objects.
- Positioning on glass shelves can cause disturbing reflections in the live image and in recordings.



Installation location

The camera is suitable for both outdoor and indoor use.

Do not place the camera in the direct vicinity of heaters, stoves, other heat sources or under direct sunlight. Operate the unit only in locations with temperatures within the permissible ambient temperature range $-20^{\circ}\sim 50^{\circ}\text{C}$.

3.3. Installing the camera with a wall bracket

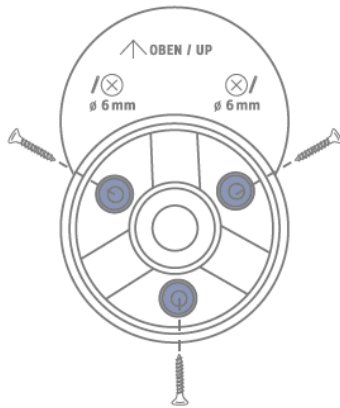

Mark three holes on a flat wall using the template, drill the holes (6 mm drill bit required) and attach the back plate of the bracket (mounting material enclosed).

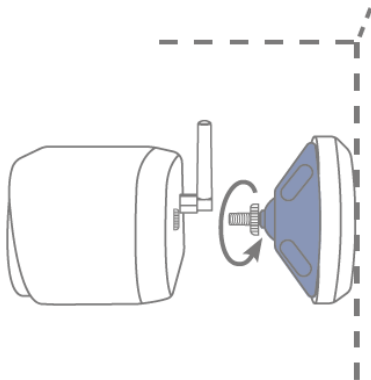

Insert the ball joint, fit the cover of the bracket and tighten. Then position the fixing ring and tighten slightly.

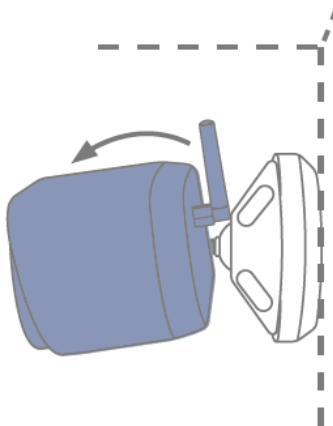

Turn the camera onto the thread of the ball head and align it with the desired detection area. Tighten the fixing ring in order to secure the camera in this position.



Attention!

If possible, place the camera under a canopy or similar to avoid direct sunlight. The camera should not be pointed directly towards a light source or the sun.

3.4. Notes on the recognition of persons

The person recognition function allows you to differentiate between objects. As soon as the PIR (passive infrared sensor) triggers, the camera software searches for specific characteristics of a person in the image. Environmental influences such as sunlight, heat, wind, rain, snow or insects can cause false recognition in very rare cases.

Objects that look similar to the outline of a person are also detected as persons in rare cases. Example: A flag in the wind that is interpreted as a person in a raincoat.



Please note that person recognition depends on the distance, viewing angle and size of the person (seen from camera to object).

	<p>Note The function significantly reduces push notifications compared to the "Motion detection via PIR" function. Environment-dependent individual fine-tuning of the sensitivity is always required to achieve maximum accuracy. However, one hundred percent accuracy and the complete exclusion of false alarms are not possible.</p>
---	---

When a person is detected, a recording is triggered even if the person is not moving. When a person is detected, you will receive a PUSH notification about a detected person.

	<p>Note Frequent false triggering affects the battery life of your camera. The camera requires battery power as soon as it has to end standby mode due to a heat source. This therefore also applies when the integrated PIR sensor detects animals or surfaces heated by the sun that do not trigger a push notification, for example. Tips: If necessary, mount or fine-tune the camera so that unimportant heat sources are detected less frequently and/or set up schedules.</p>
---	--

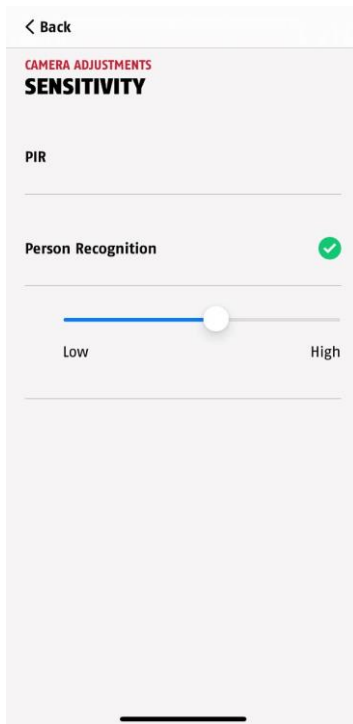

In order to achieve optimal performance of the person recognition function, certain conditions have to be observed as regards installation or the field of view of the camera:

1. The installation height of the camera should be chosen between 2 and 3 metres.
2. The object height in the image area must be between 1/16 and 1/2 of the image height. If objects in the image are shown too large or too small, they may not be detected correctly.
3. Note that the vertical viewing angle of the camera is 75° degrees so that persons directly below the camera are not captured by the function, for example. People who can only be seen from above in the live image may also not be recognised as persons.
4. Reflective surfaces in the image area can interfere with the recognition of persons.
5. Make sure that there are no branches or leaves in the image area in the close-up range of the camera.
6. If you do not want the camera to trigger when you are present, set up corresponding schedules via the app or deactivate the "Motion alarm" function in the live view)

3.5. Installing the camera and base station

The camera with IP65 protection class is suitable for outdoor use. The base station is intended for indoor installation only. The base station supports up to four Battery Camera Pro devices. The process of teaching the base station to the app is described in 4. *App2Cam Plus: First access*. For external access to the camera, you need a router with internet access.

**Note**

Position the base station so that it is not covered by objects.
Ensure optimal ventilation of the base station.

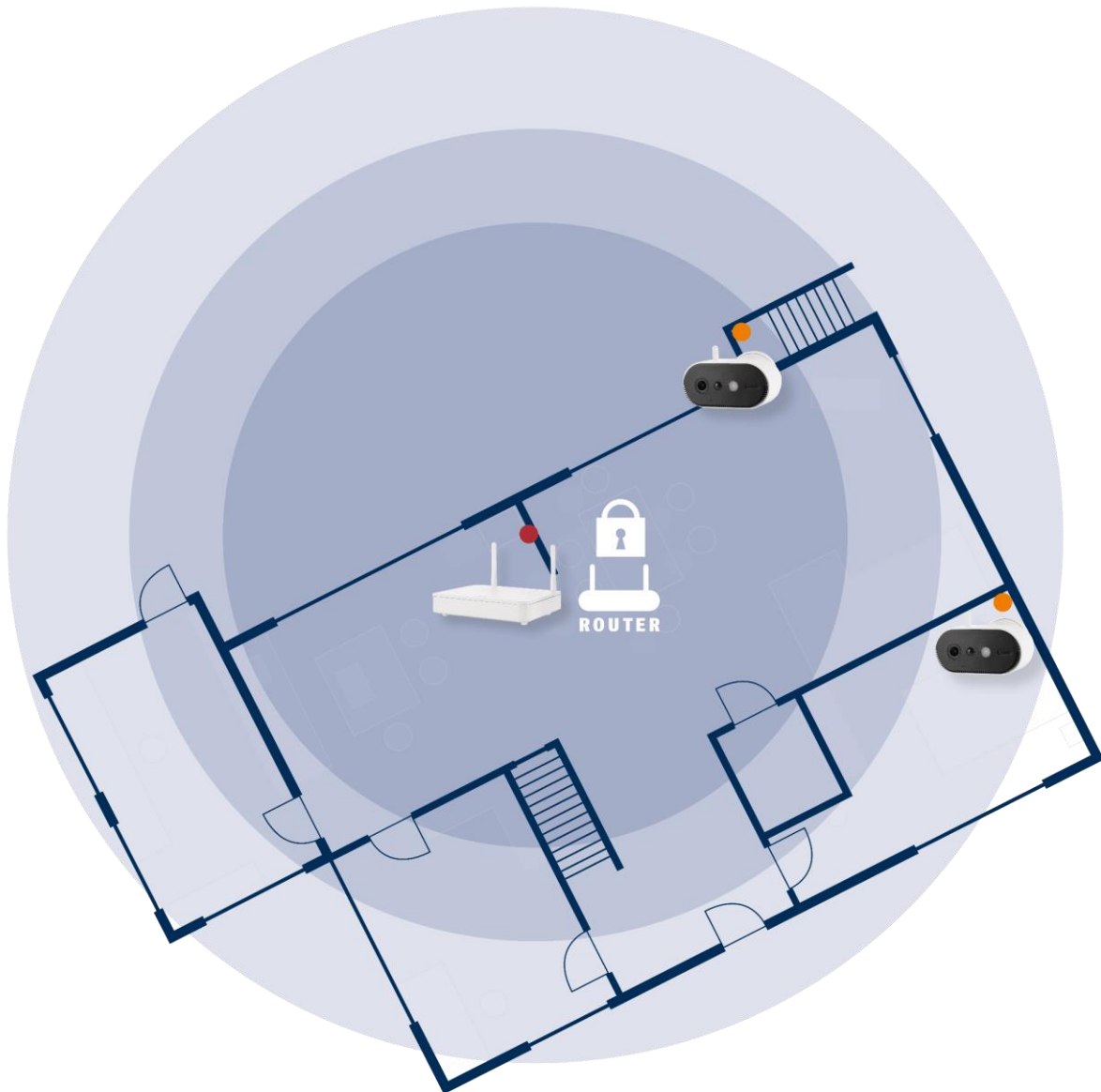

Positioning the camera and base station

The base station of the battery camera Pro requires a connection to your router via network cable. To do this, use either the enclosed network cable or a commercially available longer/shorter LAN cable of your choice. If your home has several network connections, you can of course place the base station so that it is as close as possible to the camera for better reception.

Please note that structural conditions on site (e.g. walls, ceilings, metals, glass) can influence radio transmission between the camera and the base station.

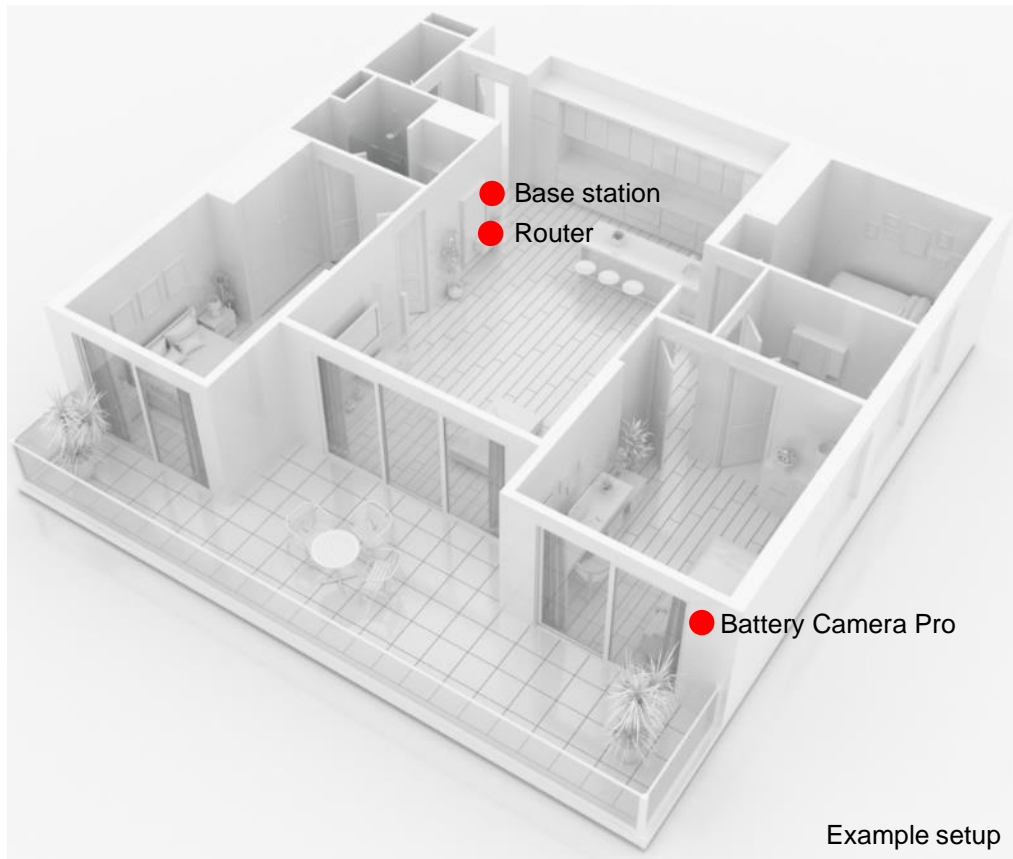

In an installation with two or more cameras, the base station should be placed as centrally as possible so that all cameras are within range of the base. The reception of the individual cameras is shown in the live view by means of the signal strength symbol.

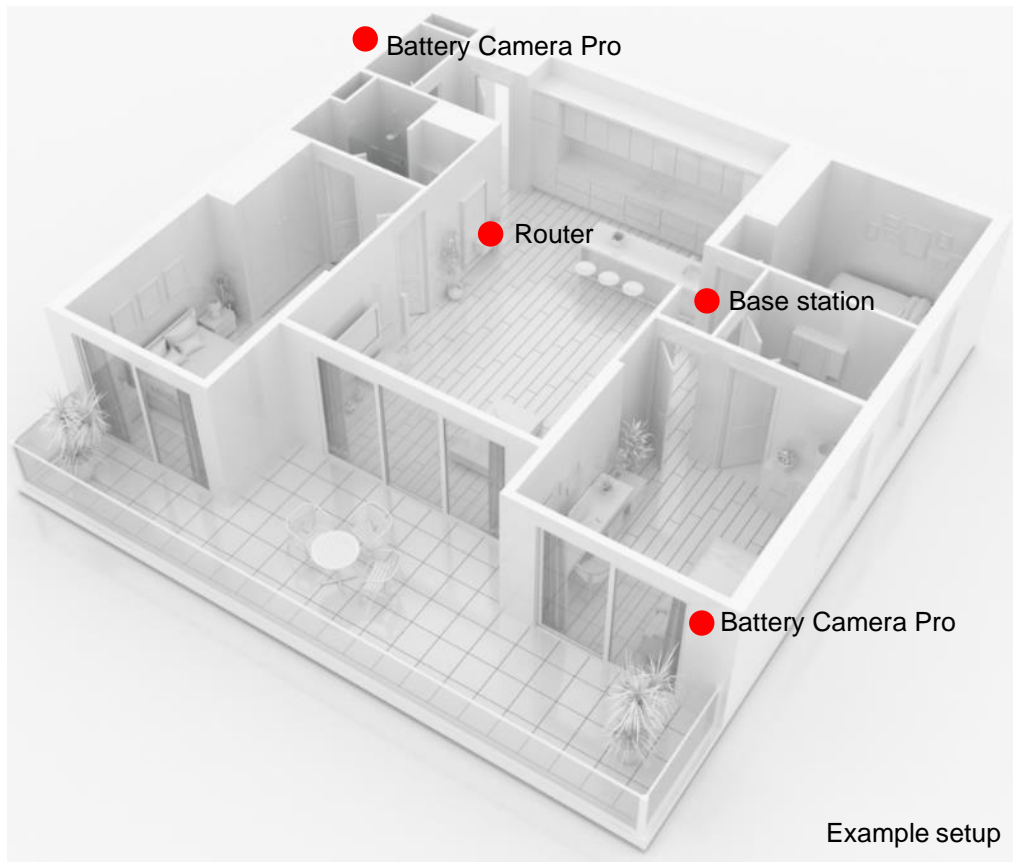

3.6. Placement of base station without drilling

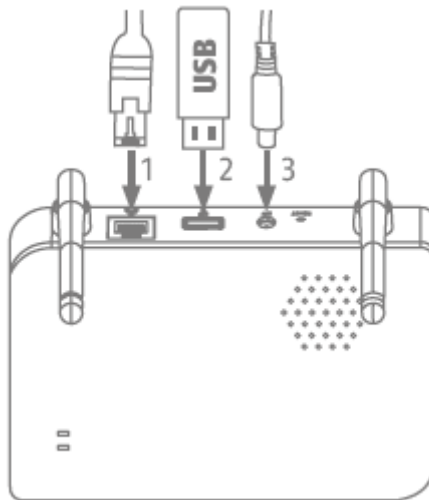

First plug in the network cable and the USB memory (with max. 128 GB storage capacity; not included in the scope of delivery). Then connect the power cable to the base station.

3.7. Mounting the base station on the wall

**Attention!**

Position the base station so that it is not covered by objects.
Ensure optimal ventilation of the base station.

Mark two holes on a flat wall using the template and drill the holes (6 mm drill bit required).

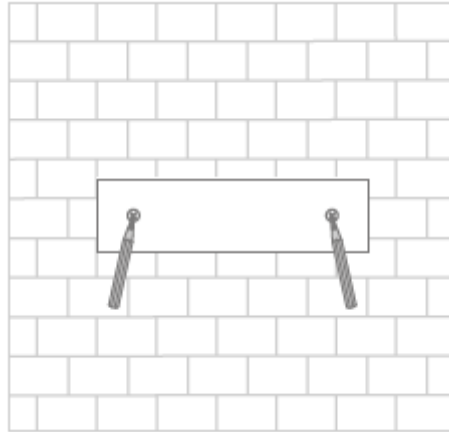

Install dowels and screws (see scope of delivery), then hook in the base station.

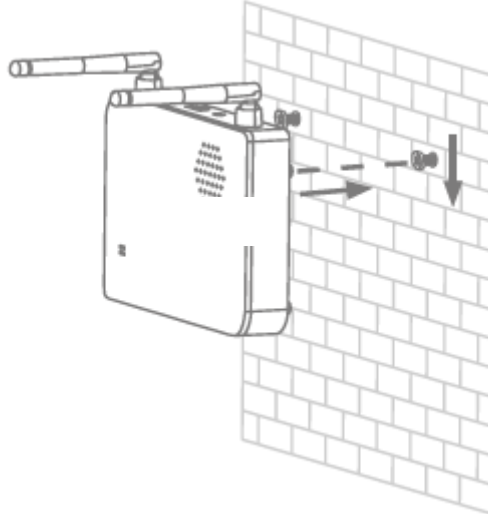

To save recordings, insert a commercially available USB stick (with max. 128 GB storage capacity; not included in the scope of delivery).

First plug in the network cable and the USB memory (with max. 128 GB storage capacity; not included in the scope of delivery). Then connect the power cable to the base station.

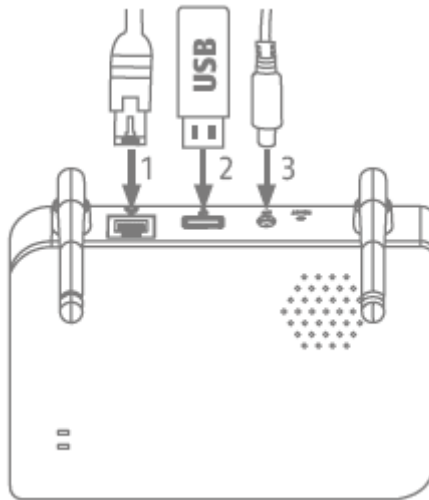

4. App2Cam Plus: First access

4.1. System requirements

Please observe the following points to ensure easy start-up:

- Router (for connecting the base station) and home network (for access via app)
- Smartphone and base station must be in the same network.
- Network with password and encryption.
- Networks without encryption are not supported.
- The location service of the mobile device must be activated for network integration.
- The camera can only be used in conjunction with the App2Cam Plus app
- Max. four cameras per base station and max. 8 base stations in the App2Cam Plus.
- To save recordings, insert your own/standard commercially available USB stick into the base station (max. 128 GB storage capacity)

4.2. Downloading the app

Download the "App2Cam Plus" app from the Google Playstore or Apple App Store for first access.

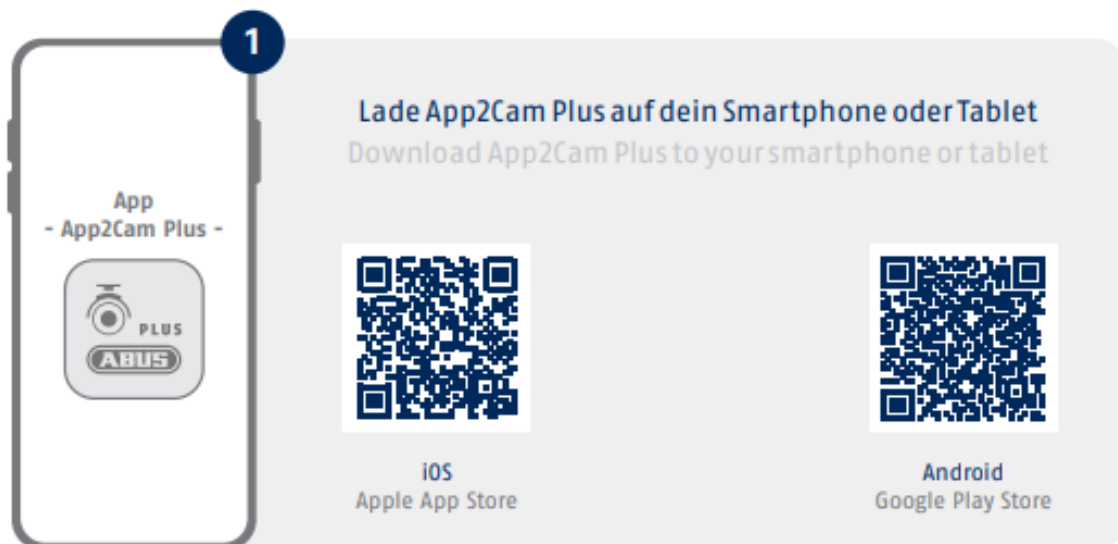

During installation, help pages are available for the various steps. Click on the  icon to access the help.

The app requires various permissions. Depending on the operating system of your mobile device, the corresponding requests are made at the beginning or at the end of start-up.

4.3. Setting up the camera

4.3.1. LAN setup

Before you start setup, first connect the network cable and (for recordings) a standard commercially available USB stick to the base station. Then connect the power cable to the base station. If you insert a USB stick later: first disconnect the base from the power supply so that the storage medium is recognised correctly.

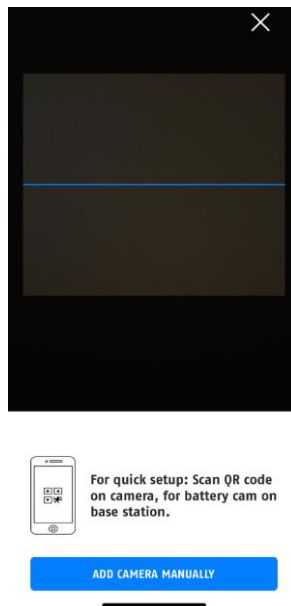
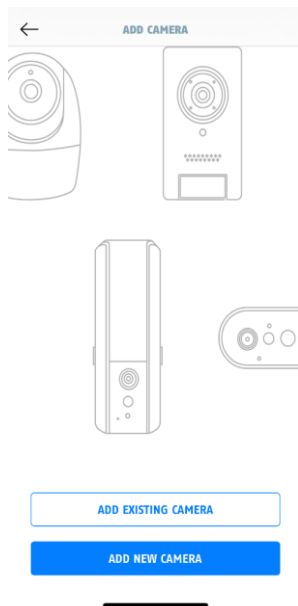
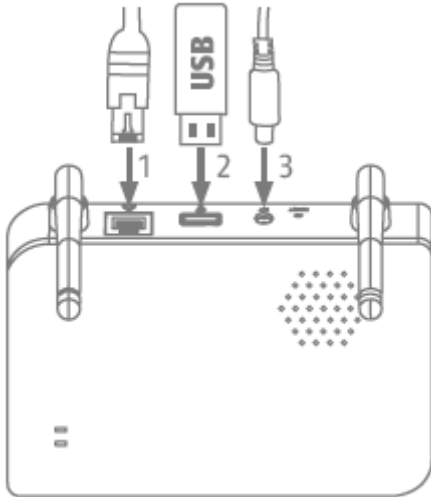

1. Start App2Cam Plus and select "Add new device" to start the start-up process.
2. Option 1: Scan the QR code on the bottom of the base station.
3. Option 2: Tap on the "Add device manually" button and then select your camera model from the list.

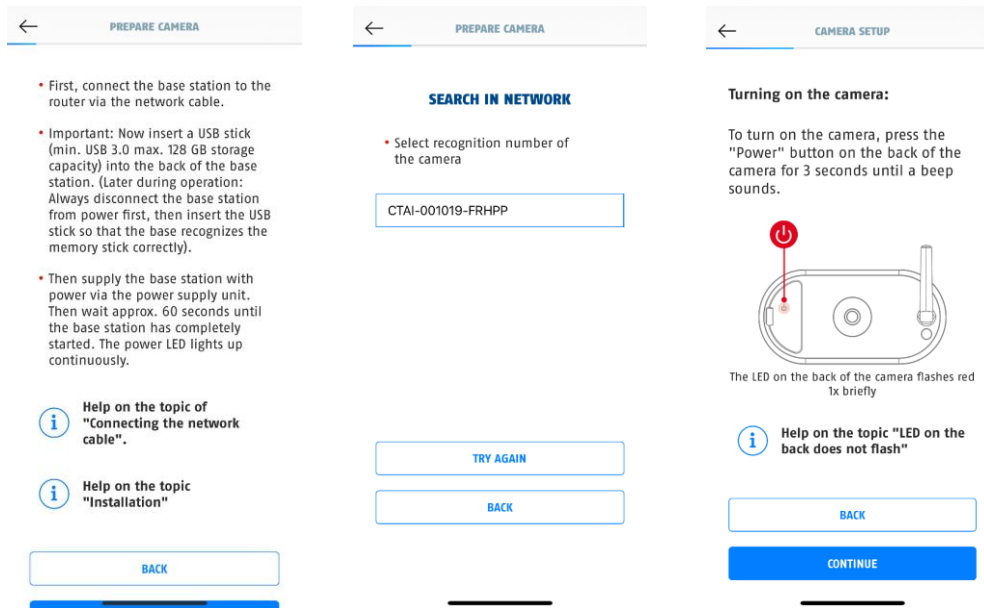

- If you have not already done so, first connect the base station to the router via the network cable. Then connect the base station to the power supply. The base station is ready as soon as the red power LED lights up. Click on "Search camera in network" to continue with the installation.
- Select your base station using the identification number. You will find the identification number (DID) enclosed in the packaging. Alternatively, this can be found on the underside of the base station.
- Attach the camera antenna (if you have not already done so) and switch on the camera by pressing and holding the On/Off button on the back of the camera for 3 seconds. This causes the status LED on the back of the camera to flash (red). Confirm in the app with "Next".

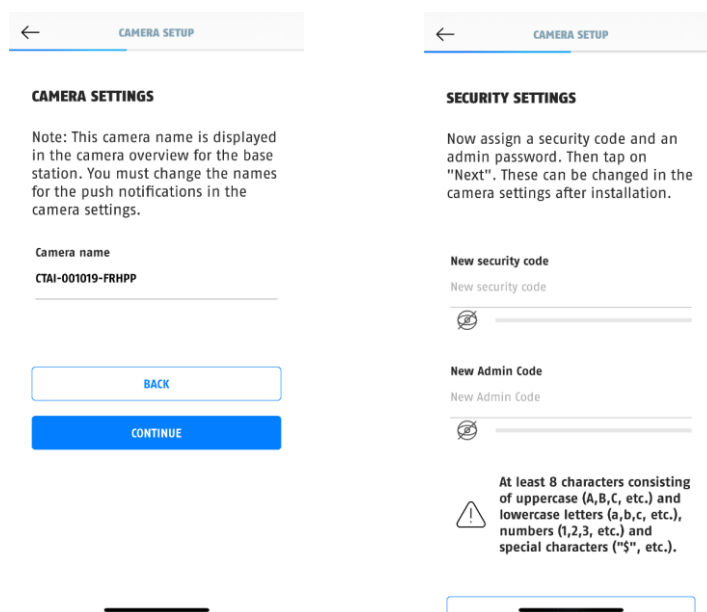

- Assign a name for the base station. This name will be displayed later in the camera overview. For push notifications, you must also enter the name in the camera settings after start-up. The name can be changed later on at any time.
- Now assign a security code and an admin password. Then tap on "Next".
- For the best possible camera experience, we recommend that you always operate the base station and cameras with the latest firmware. Confirm the message with "OK".

4.3.2. Adding a base station that has already been set up

If a base station has already been set up via another smartphone or user, select this method to add previously set up base stations.

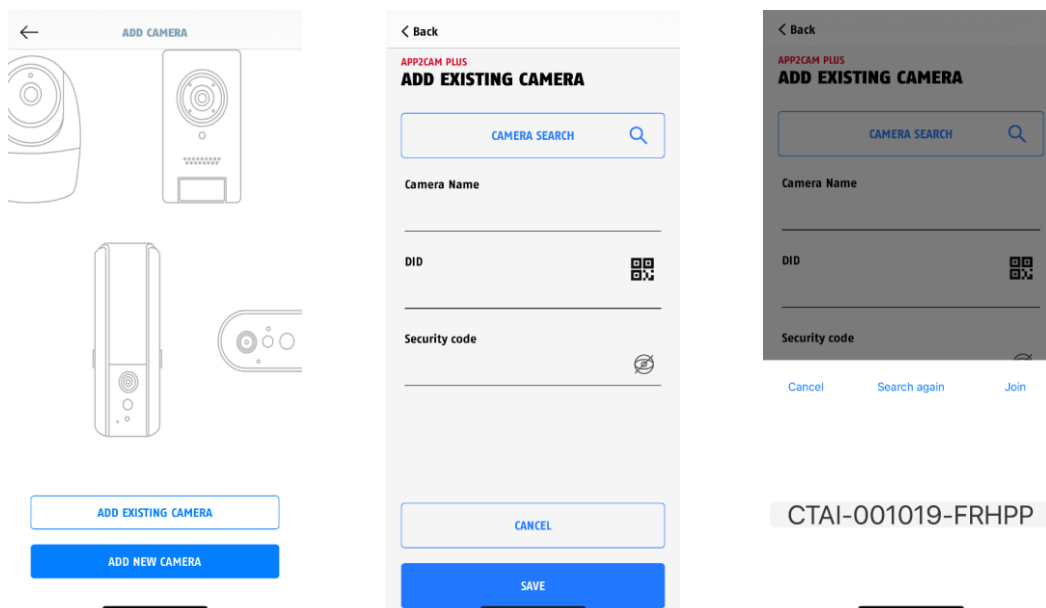

Open the app and click on "Add connected device" to add a camera, then click on "Add connected camera".

Enter a name for your base station. To enter the DID, you have the following options: scan the QR code on the bottom of the base station or search for the base station in the network using the "Search camera" button or enter the DID of the base station manually.

Enter the security code already assigned to the base station.

Press the "Save" button to add the base station.

You have now successfully completed start-up.

4.3.3. Assigning a new camera to a base station

The camera and base station are already paired/connected when delivered from the factory or in a common set package (PPIC91000, PPIC91520); in this case, skip this step. This step is only necessary if the items/components have been purchased individually or independently of each other; i.e. usually after purchasing an additional camera (PPIC91520).

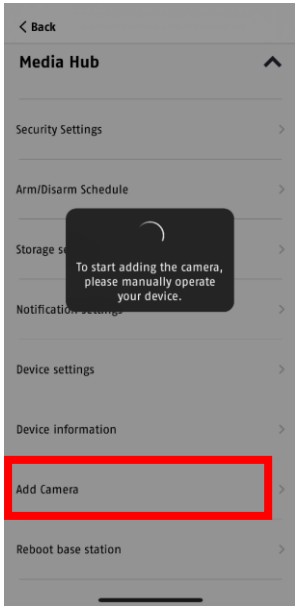

Carry out the following two steps within 1 minute.

1. In the app, go to the path: Camera overview > Live view > Camera settings > Base station settings > Add camera

Press and hold for 3 seconds

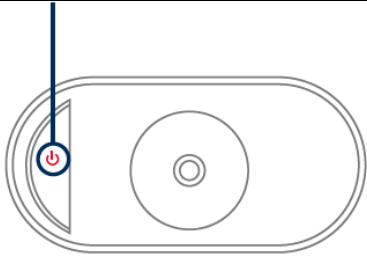

2. Switch on the camera by pressing and holding the On/Off button for 3 seconds.

On the back of the camera, the status LED (red) lights up and the camera outputs a signal tone.

The camera is in pairing mode ex-works and now automatically connects to the base station.

As soon as the camera and the base station are connected (if not deactivated in the settings), this is confirmed by voice output from the base station: "Camera connection successfully completed"

If start-up was not successful, start pairing again using the app. You also have to press the camera's On/Off button three times in succession to start pairing mode manually. A signal tone should be output when activated.

4.4. App2Cam Plus: Overview

	<p>Note</p> <p>Please note that some of the functions explained or shown in these instructions may not be compatible with older generation camera models, or the camera functions may be different due to differences in the hardware.</p>
	<p>Note</p> <p>The screenshots and icons shown were taken from the iOS app.</p> <p>The Android app contains slightly different labels, layouts or functionalities to a minor extent.</p> <p>This is described in the respective items or mentioned with the additional information (iOS only) or (Android only).</p>





During operation, the app usually starts with the camera overview.

By tapping on the preview image, you can access the live view including the live image of your camera(s) and there continue to the settings for the base station and the camera(s).







Note: Since the Battery Camera Pro is connected to the app via the corresponding base station, you will always see a preview image in the camera overview, even if several cameras are connected to one base station (more details are provided on this in the following section on the live view).

The menu at the bottom of the screen takes you to the recordings (if the USB stick is inserted and correctly recognised) and also to the app settings and general information.

4.4.1. Camera overview

 Add new camera	Setting up new camera / Add camera
	Motion alarm function is activated (also see Live view)
	Activation of the 4-fold view
	Update the connections to the cameras
Delete camera	Swipe the camera you want to delete to the left in the camera overview. A red button appears; click on this to delete the camera.

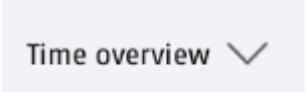
4.4.2. Recording menu/Recordings/Storage

	Delete displayed recordings ATTENTION! Icon displayed in app at top right: delete all existing recordings Delete individual recording: Swipe to the left in the line with the corresponding preview image; tap on the recycle bin that appears
	Connection update Update the connections to the cameras
	Camera and channel selection (1-4) Channel order = order of the Battery Camera Pro devices put into operation
	Select period
	Display bar chart Number of recordings within the last few days. Tap to set corresponding filter
	Shows recordings of the last 24 hours or with trigger person

4.4.3. Info / App settings

 Einstellungen	
Discover ABUS	Here you will find ideas for using the app, the camera and compatible devices.
Rate app	Rate our app and send us your suggestions for improvement.
Instructions	You can find more information about the app and your device in the Quick Guide, at support.abus-sc.com , on the ABUS YouTube channel, or at abus.com .
Video acceleration (Android only)	<p>Enable/disable hardware decoding</p> <p>Hardware decoding is available for use on Android. Some Android devices have special hardware features that optimise decoding of video streams. On older products or older Android devices, this may impact negatively on performance.</p>
Notification settings	Activation / deactivation of push notifications via the smartphone / tablet settings
App code	<p>Assign a secure app password to protect against unauthorised access.</p> <p>Password input is requested every time the app is started. If you have forgotten the code: Uninstall app, download again, add base/camera(s) again and make personal settings.</p>
Legal topics	Here you will find all legally relevant documents
App info	Information about the currently installed app version

4.5. App2Cam Plus: Live view

4.5.1. Live view functions



Einstellungen für diese Kamera vornehmen
Make settings for this camera



Bewegungserkennung ist aktiviert
Die eingelernten Kameras zeichnen bei Bewegung auf und versenden Benachrichtigungen (Push oder E-Mail), wenn diese in den Einstellungen der Basisstation aktiviert sind.

Alarm is active
The camera records when movements are detected and sends notifications (push or email) if the functions are activated in the camera settings.



Bewegungserkennung ist deaktiviert
Die Kamera zeigt ein Livebild, führt aber keine Bewegungserkennung durch.

Alarm is deactivated
The camera shows a live image but does not perform motion detection.

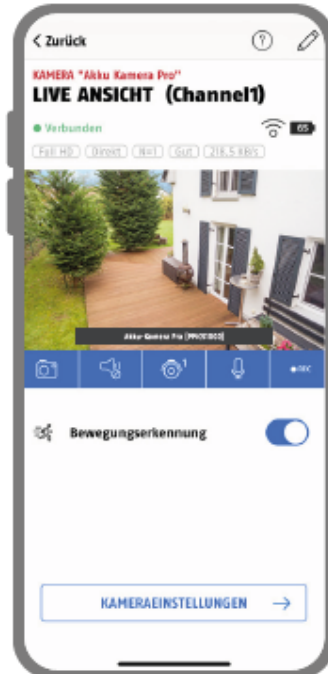

Schnappschuss erstellen
Take snapshot



Manuelle Aufnahme starten
Start manual recording



Audio aktivieren/deaktivieren
(für Aufzeichnungen mit/ohne Ton, siehe Kameraeinstellungen)
Activate/deactivate audio
(for recordings with/without sound, see camera settings)



Gegensprechfunktion
Zum Aktivieren des Mikrofons deines Endgerätes und des Lautsprechers an deiner Kamera drücke dauerhaft auf das Mikrophon-Symbol. Die Verbindung zur Kamera bleibt offen, solange du das Symbol gedrückt hältst.



Wechsel zwischen Kamera 1/2/3/4
Switch between camera 1/2/3/4

Intercom function
To activate the microphone on your mobile device and the loudspeaker on your camera, press the microphone icon continuously. The connection to the camera remains open as long as you keep the icon pressed.

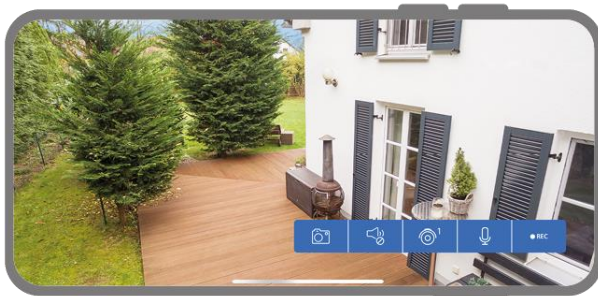



Activate landscape mode simply by rotating your phone/tablet sideways.

4.5.2. Camera indicators

<p>CAMERA "CTAI-000050-CHTWM"</p> <p>LIVE VIEW (Channel1)</p> <p>● Connected</p>	
<p>CAMERA "CTAI-000050-CHTWM"</p>	<p>Camera name You can change the name of the camera in the camera settings.</p>

4.5.3. Stream indicators

<p>Full HD Direct N=1 Good 61.3 KB/s  100</p>	
<p>CIF VGA HD Full HD</p>	<p>Image resolution of the current stream</p>
<p>Direct Relay server</p>	<p>Current connection status Direct: The Peer2Peer Server was able to set up a direct connection between your end device and the camera. Relay server: The Peer2Peer Server was unable to set up a direct connection. The video data is saved on the relay server for a short time so that your mobile device can get the data from the server. This causes a delay in the stream. See also note after this table.</p>
<p>N = 1</p>	<p>Number of mobile devices currently accessing the live view</p>
<p>Low Normal Good</p>	<p>Current connection quality This shows the connection between the base station and the router.</p>
<p>xxx KB/s</p>	<p>Display of the current kilobit consumption per second</p>
	<p>Connection strength from base station to the camera whose live image is currently being displayed</p>
	<p>Current battery status of the camera whose live image is currently being displayed</p>

**Note**

If the connection to your camera is always established via the relay server, please check the following settings:

- Check whether UPnP is activated in your router.
- Check whether a hardware firewall or a software firewall is preventing a direct connection.
- Check whether several "hops" (routers) are installed between the device and the internet.

4.6. App2Cam Plus: Recordings

4.6.1. Recording menu

Tap the Recordings icon in the camera overview to open the event list.

In the event list you can set a start and end time; click on the date selection for this. With this filter, the app will show you all recorded events in this period.

In the time overview, the frequency of the triggers is displayed for different time periods.

Recordings with object recognition are displayed with icons for recognition.

Click on the preview image to view it; the triggering object is shown here.

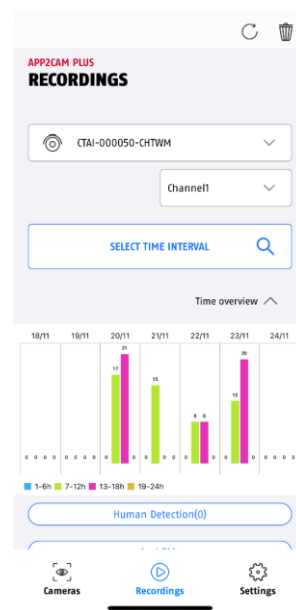
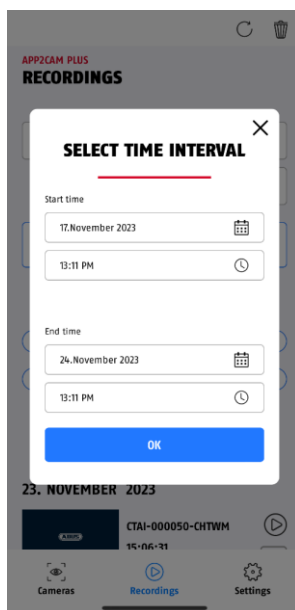
**Note**

Note the set duration for recordings. Recordings are displayed in the memory as soon as they are completed.

4.7. Playback





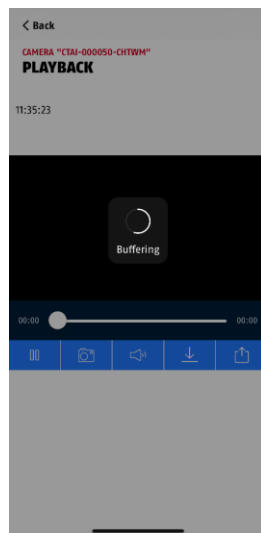



Playback of a recording is started by tapping on an entry in the event list in the "Recordings" screen. Various functions are available in playback mode. In landscape mode (hold mobile phone/tablet sideways), you see the recording in widescreen format.

The recordings usually require a short loading time before they can be played.



	<p>Note During playback, the recording is temporarily stored on your mobile phone/tablet. If you want to keep your mobile data volume low, we recommend using the playback mainly via Wi-Fi.</p>
---	---

4.7.1. Playback functions

	
	<p>Pause playback</p>
	<p>Start playback</p>
	<p>Take snapshot</p>
 	<p>Activate/deactivate audio output Here you have the option to activate or deactivate audio for playback.</p>
	<p>Download recording Storage location iOS: Gallery Storage location Android: in the device manager under "Internal storage/Movies"</p>
	<p>Share recording (forward)</p>

4.7.2. Download and share recording (download/forward)

To download a file to your smartphone, click on the download icon. The file is now downloaded and is subsequently displayed in red in the recording list.

You can share the file by clicking on the Share icon.

	<p>Note</p> <p>The downloaded data is stored differently on the iOS and Android operating systems.</p> <p>iOS: The events are stored on the device and can be accessed in the gallery.</p> <p>Android: The saved data can be found in the device manager under "<i>Internal storage/Movies</i>".</p>
---	---

4.7.3. Opening camera settings

To open the camera settings, click on the corresponding button in the live view.

Use the admin password that you entered during start-up.

	<p>Note</p> <p>The admin password was assigned during start-up. It is used to protect your personal settings if several users have access to the camera. Only pass it on if other users are also to be given access to the camera and base station settings.</p> <p>If necessary: Activate "Save admin password" to access the settings from the next access without entering a password.</p> <p>You can change your admin password at any time in the settings.</p>
---	---

4.7.4. Camera information

This screen contains initial information about the camera and the base station.

In the live view, click on the pencil in the top right-hand corner to access the camera information.



System name:

Change the name of the camera here; this name appears in the camera overview

DID:

Device ID of the base station as selected/entered during set-up; do not change, otherwise the connection will be terminated.

Security Code:

Enter the security code of the camera here.

Tap "Save" to go to the settings of the base station and camera.

4.7.5. Camera settings

Settings are available for the base station and for the cameras.

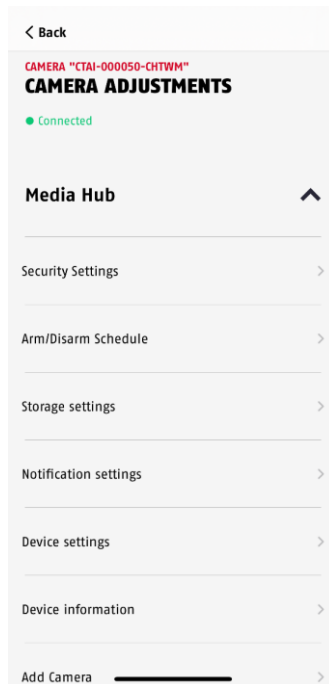

In the base station settings, you have the option of deleting cameras from your base station.

**Note**

Although the individual items have a different layout than in Android, the functions are identical and available on both platforms.

**Note**

Always make changes to the camera's settings (e.g. changes to the admin password) in the camera's local network. We strongly advise you not to change settings in a public Wi-Fi network, as it is always possible for other people to record the settings.

4.7.6. Base station settings

4.7.6.1 Security settings

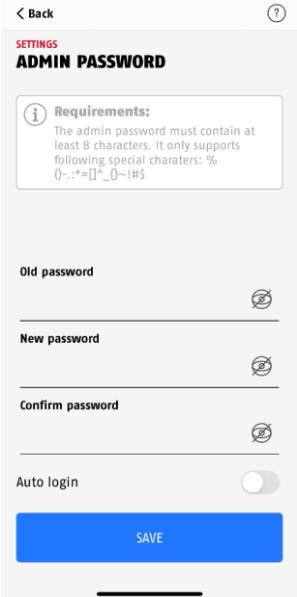
Security settings		<p>Make the security settings for your base station here.</p> <p>The changes in the settings are applied only after exiting the menu.</p>
Change security code		<p>The security code was assigned during set-up. It is used to permit access via additional mobile phones/tablets.</p> <p>If you have forgotten your security code, you can carry out set-up again by resetting to the factory settings.</p> <p>IMPORTANT: All settings will be deleted and the network connection disconnected. For help on resetting to factory settings and set-up, please refer to the relevant chapters of this manual.</p>
Change admin password		<p>The admin password grants access to the settings of the base station and permits activation/deactivation of motion detection.</p> <p>During installation, you assign your own admin password.</p> <p>If you have forgotten your admin password, you can carry out start-up again by resetting to factory settings.</p> <p>IMPORTANT: All settings will be deleted and the network connection disconnected. For help on resetting to factory settings and set-up, please refer to the relevant chapters of this manual.</p>
End Auto Login		<p>If you have already activated Auto Login, you can deactivate the function here.</p> <p>This menu item is only displayed if the function has already been activated.</p>

4.7.6.2 Schedule settings

Activation/deactivation schedule

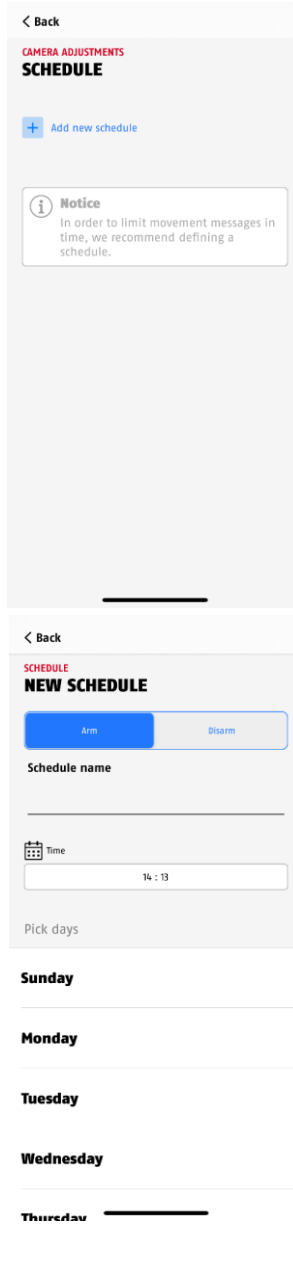

Schedule settings

Tap the plus symbol  to add a schedule that automatically activates or deactivates the "Motion detection" function (see Live view).

You can save a schedule if you want to activate or deactivate the motion detection of all cameras at certain times. For example, if you are at home at certain times and do not want to receive any notifications.

Separate schedules are created for activation and deactivation.

Select the time of activation and assign a schedule name for it.

Select the days for repetition if necessary. Save the schedule with the "Save" button.

For example:



Start time 21:00 from Mon-Fri, action Arm

End time 06:00 from Mon-Fri, action Disarm

The camera records only during the period between 9 pm – 6 am when there is movement.

To delete a schedule, tap the recycle bin icon in the top right-hand corner and then tap the corresponding button with the minus icon.

4.7.6.3 Storage settings

<p>Storage settings</p>		<p>Record without audio</p> <p>Activate the function to save the recordings without audio. For sound recordings, observe the relevant country-specific regulations.</p> <p>Regardless of the audio setting selected for recordings, you can use the intercom function/audio at any time within the live view.</p> <p>Ring memory function</p> <p>There are several ways to overwrite the events on the USB stick.</p> <p>OFF</p> <p>As soon as the USB stick is full, no more recordings are saved.</p> <p>Activated</p> <p>If this function is activated, the oldest recordings are overwritten with newer ones as soon as the USB stick is full.</p> <p>3 / 7 / 30 cycle</p> <p>The data on the USB stick is deleted or overwritten after the selected number of days.</p> <p>The changes in the settings are applied only after exiting the menu.</p>
<p>Recording time</p>		<p>Change the duration of the recording time.</p>
<p>Format USB stick</p>		<p>Format the USB stick.</p> <p></p> <p>When the USB stick is formatted, all data on it is deleted. Before formatting, back up your data on other media/devices as needed.</p>

4.7.6.4 Notification settings

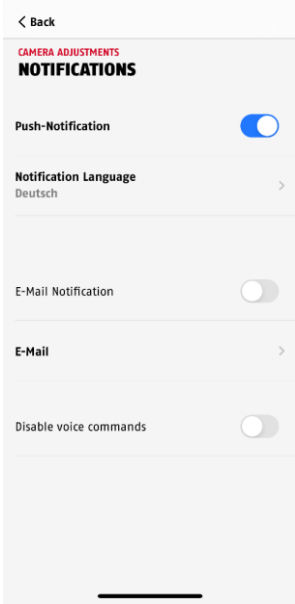
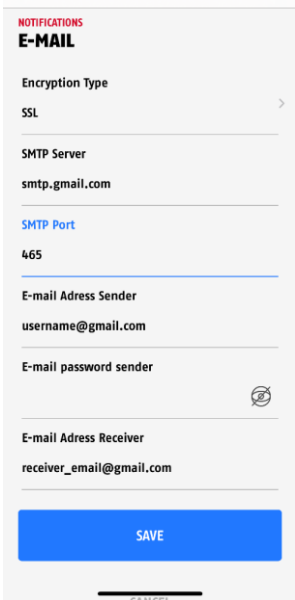
<p>Activate push notification / Notification language</p>		<p>Push notifications</p> <p>Activate push notifications to receive notifications based on motion detections to your smartphone if the "Motion alarm" function is activated at the same time (see Live view or Schedules). You will also receive notifications when the battery level of a camera drops below 15% or when a firmware update is available. Also make sure to grant the app the appropriate permission in the settings of your mobile phone.</p> <p>Notification language</p> <p>You have the option to change the language of the notification under Notification language.</p> <p>Please note that only the language of the push notifications will be changed. The language setting for the app remains the same and must be changed in the smartphone.</p> <p>((Add if none come, analogous to the help article?))</p>
<p>Email notification / Email</p>		<p>Email notification</p> <p>Activate email notifications to receive emails based on motion detections to a mailbox of your choice if the "Motion alarm" function is activated at the same time (see Live view or Schedules). Make sure to enter further details about your mailbox under "E-Mail".</p> <p>E-Mail</p> <p>Use SSL/TLS:</p> <p>Activate the checkbox to transmit e-mail in encrypted form. You can obtain the necessary settings from your e-mail provider.</p> <p>SMTP server:</p> <p>Enter the SMTP server address here, e.g. smtp.test.com</p> <p>SMTP port:</p> <p>Enter the SMTP port here, e.g. 465</p> <p>Sender e-mail address:</p> <p>Enter the sender's e-mail address here, e.g. xxx@test.com</p> <p>Sender e-mail password:</p> <p>Enter the sender's e-mail password here.</p> <p>Recipient's e-mail address:</p> <p>Enter the recipient's e-mail address here, e.g. xxxx123@test.com</p>

		<p>Save the settings with OK. When exiting the advanced settings, press "Confirm". Only then will the e-mail settings be applied.</p>  <p>We recommend using "googlemail" to send e-mails.</p> <p>You can find instructions on how to set this up under Downloads at abus.com.</p>
Deactivate voice commands		<p>Activate or deactivate the voice commands of the base station.</p>

4.7.6.5 Device settings

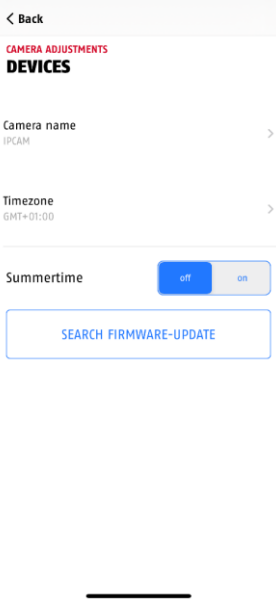
Device settings		<p>The changes in the settings are applied only after exiting the menu.</p>
Camera name		<p>Change the base station name here for the push notification when motion detection is activated/deactivated.</p>
Time zone / Daylight saving time		<p>The world time zones are listed in the selection list. Select the time zone in which the camera is installed.</p> <p>For Germany: If the world time zone uses the changeover to daylight saving time, activate daylight saving time.</p>
Check now for firmware update		<p>By selecting the menu item "Check for firmware update" you can search for current firmware updates.</p> <p>Note: To download and install a new firmware version, a USB storage device must be plugged into the base station and correctly recognised.</p> <p>The update is searched for in the background and cached on the USB stick.</p> <p>Then exit the settings. After about 5 minutes you will receive a push notification that the new camera firmware is ready for installation.</p> <p>IMPORTANT: Do not disconnect the base station from the power supply during the update. Now go to the device settings again and tap on "Install the firmware update now".</p> <p>The update may take a few minutes and is completed when access to the live image is working again.</p>

4.7.6.7 Device information

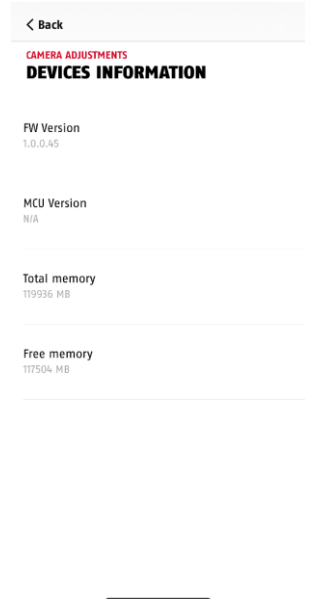
<p>About device</p>		<p>The device information gives you information on the installed firmware version of the camera, the total available memory and the free memory on the USB storage medium.</p>
----------------------------	---	--



4.7.6.8 Add camera

<p>Add camera</p>		<p>Here you can integrate another camera into the base station.</p> <p>For more information, see section 4.3.3</p>
--------------------------	--	--

4.7.6.9 Restart base station

<p>Restart base station</p>		<p>Here you can restart the base station if there are problems with the connection between the base and the camera(s). All settings are retained.</p>
------------------------------------	--	---

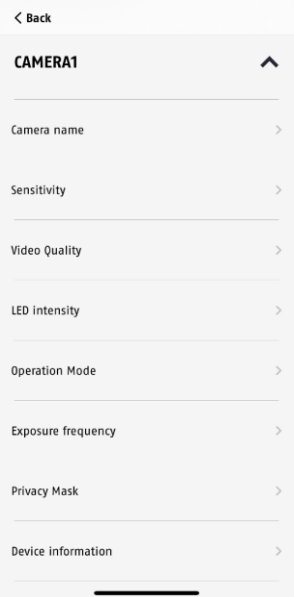
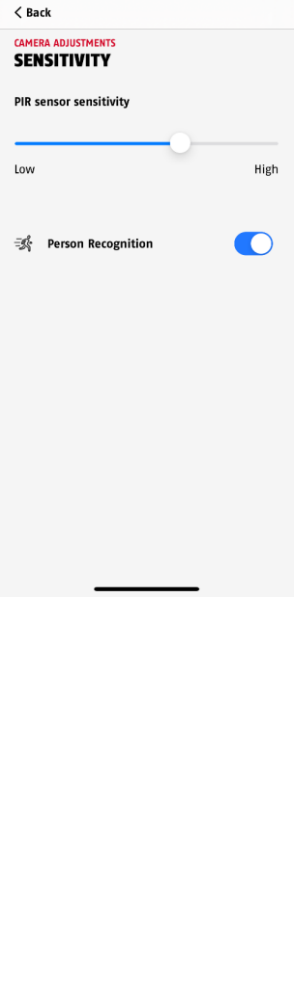
4.7.8. Camera settings (camera 1-4)

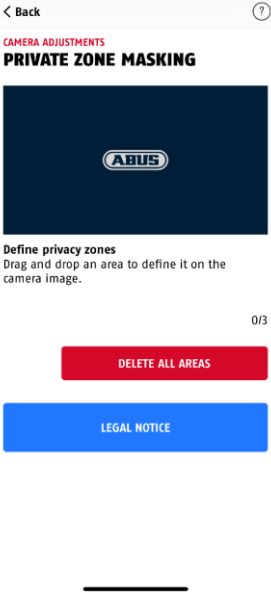

<p>Camera settings</p>		<p>Here you can make the settings for the individual cameras.</p> <p>If several cameras are connected to the base station: the order corresponds to the order of the respective start-up.</p>
<p>Camera name</p>		<p>Change the camera name of the taught-in cameras here.</p> <p>The name is displayed in the live view as well as in the push notifications.</p>
<p>Sensitivity</p>		<p>Two modes are available for motion detection.</p> <p>PIR</p> <p>The camera detects heat using the integrated passive infrared sensor, or PIR for short. Adjust the PIR sensitivity according to the conditions and requirements on site.</p> <p>High = the camera triggers already at low heat movement, e.g. smaller animals</p> <p>Low = the camera only triggers when there is greater thermal movement, e.g. with larger animals or smaller animals that are very close to the camera</p> <p> Heat sources (heaters, fan heaters, etc.) and surfaces that are strongly heated by the sun (stones, glass, etc.) are also detected by the sensor; do not point the camera at them.</p> <p>Recognition of persons</p> <p>This is a connection of the PIR sensor with the object detection function. The control adjusts the sensitivity of the PIR sensor. See section 3.4 for further information on person recognition.</p>

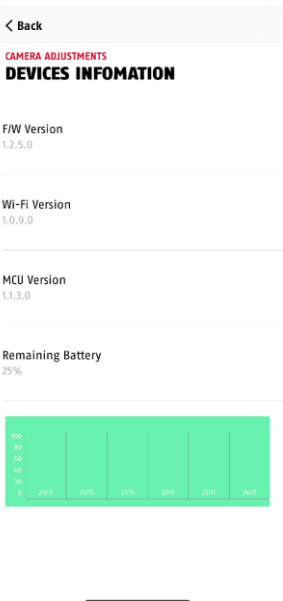
<p>Video quality</p>		<p>Here you have the option to change the resolution for the live view.</p> <p>If the network/Wi-Fi signal is poor, a lower picture resolution can help to obtain a smoother picture. Please note that less image data also results in less image detail.</p> <p>The value set here has no effect on the recording, which is always saved in 3MPx.</p>
<p>LED intensity</p>		<p>Here you can adjust the intensity of the white light LED or switch off the light completely.</p> <p>Adjust the LED intensity according to the environmental conditions.</p> <p>As soon as there are objects in the immediate vicinity of the camera, it is recommended to set the intensity to "Medium" to avoid reflections in the picture. The range of the LED is then reduced accordingly.</p>
<p>Operating mode</p>		<p>Change the operating mode to "Solar" here if you operate the camera with a compatible solar panel from ABUS. The camera then only activates itself when the battery is empty or the battery level is very low.</p>
<p>Exposure frequency</p>		<p>Here you have the option of selecting the mains frequency for your camera.</p> <p>The following selections are available: Select Indoor (50Hz), Indoor (60 Hz) and Outdoor.</p> <p>Default value for Germany: 50 Hz</p>
<p>Privacy zone masking</p>		<p>A preview of the live image and the set up privacy zone(s) is displayed here.</p> <p>Loading the live image takes a few seconds.</p> <p>Privacy zones are defined directly in the preview area. You can draw up to 3 areas (rectangles) with your finger and place and adjust them individually using drag and drop.</p> <p>The app makes marked areas unrecognisable in the live view. The areas are also not recognisable in the recordings.</p> <p>To delete zones, tap on "Delete all zones" or on the "-" sign next to the desired privacy zone. The changes are only applied when you exit the menu item by clicking on "Back".</p>

Device information		<p>The device information shows you the current firmware version, Wi-Fi firmware version, MCU version and the current state of charge of the respective camera.</p>
Delete camera		<p>You have the option of deleting a camera from the base station.</p> <p>First tap on "Delete camera" and then confirm with "Yes".</p>

5. Update firmware

You can update the firmware of your base station in two different ways. Please note that the settings of the base station are still retained with both methods so you do not need to set them again.

	<p>The following applies to both update variants: A USB storage device must be plugged into the base station and correctly recognised in order to cache the new firmware version. When inserting a USB stick, make sure that the base is disconnected from the power supply so that the storage medium is recognised correctly.</p>
	<p>Updating the base station takes approx. 3-5 minutes. Do not disconnect the base station from the power supply during this time!</p>
	<p>The camera should not detect any movement during the firmware update. It is therefore recommended to place the camera on its front side. Please place the camera near the base station during the update to avoid disconnections.</p>

5.1. Update via server

Option 1:

The base station checks at 6-hour intervals whether new firmware is available on the firmware server for the camera and base station. After the base station has downloaded the firmware, a message will appear the next time you enter the camera settings so that you can start the update.

Tap on the menu item "Check now for firmware update". A message appears stating that the base station is ready for updating.

Option 2:

If you do not want to wait for the 6-hour interval, you can also have the base station actively search for a newer firmware. To do this, press the menu item "Check now for firmware updates" in the camera settings. If firmware has not already been downloaded, a newer version will now be actively searched for and then saved to the USB stick; this can take up to 5 minutes, exit the camera settings to do this.

After the base station has downloaded the firmware, a message appears the next time you enter the camera settings so that you can confirm the installation of the firmware. To do this, click on the menu item "Install the new firmware now".

Update the firmware of the cameras:

If your base station is operated with the latest firmware and the camera firmware it contains differs from the firmware installed in your camera, this should be installed.

Enter the settings of the respective camera(s) in the camera settings; all information of the camera is then retrieved and compared with the base station. If the firmware is outdated, you will find an "Update" message below the settings of the respective camera(s) with outdated firmware when entering the camera settings.

6. Overview of voice commands

The voice commands of the base station make installation and operation easier. You can deactivate and reactivate the voice commands as required in the settings of the base station.

Voice command	Help
Ready for camera connection	To add another camera to your base station, select "Add camera" in the camera settings and wait until the voice command is issued. Then press the On/Off button on the back of the camera for 3 seconds.
Camera connection successfully completed	The new camera is now connected to the base station.
Camera connection failed	The learning process was not successful. Repeat the procedure.
Firmware update successfully completed	After a successful automatic or manual firmware update.
Firmware update failed, please try again	The firmware update could not be carried out successfully. Please check whether there is enough memory on the USB stick. If necessary, delete older recordings or select the memory setting "Ring buffer: On" so that the oldest recordings are automatically deleted to make room for new recordings and updates.

7. Battery FAQs

The battery life of the Battery Camera Pro depends on various factors such as triggering frequency as well as ambient and environmental influences. Here are some tips to increase the battery life.

When should you charge the battery?

You will receive a push notification regularly as soon as the battery drops below the 15% capacity; the live view and recording will continue.

Charging the battery

Remove the camera from the bracket and plug in the USB-C cable.

Use a standard plug-in power supply unit (e.g. a mobile phone charging cable) with 5 V DC and 2 A for the charging process. The battery is fully charged again in approx. 4 hours; the LED on the back of the camera signals this with a steady red light. When using a plug-in power supply with lower power, the charging time will be longer.

Battery life

Thanks to standby mode and intelligent motion detection, up to 6 months of operating time is possible, but this is influenced by ambient and environmental factors. With frequent triggering, the battery life drops much faster. You can improve this by aligning the camera differently. You can find more information here: <https://support.abus-sc.com/knowledge-base/was-ist-bezueglich-des-akkus-der-akku-kamera-pro-zu-beachten>

Outdoor installation

Low outdoor temperatures can negatively affect the camera's battery life. You will notice a faster drop in capacity in this case, please check the status in the camera's settings and recharge early enough.

Different battery life in two cameras

If you have taught-in several cameras in your base station, the operating times of the cameras may differ.

Depending on where and at what distance the cameras were installed, the batteries can be subjected to different loads.

The following factors can influence this:

- Trigger frequency
- Signals that interfere with Wi-Fi transmission
- Temperature differences
- Outdoor installations
- Distance of the cameras to the base station; the closer the cameras are to the base station, the less battery power that is consumed
- Recordings at night, as more power is needed due to the white light LED.
- Permanent or extended live view and thus activation of the camera
- More frequent activation by heat sources
- Increased recordings/push notification due to person-like objects

8. Troubleshooting tips

Installation distances between the base station and the cameras

The distance between two cameras should be at least 2 m. Please install the cameras at a minimum distance of approx. 1 m from the base station to avoid interference.

If you install outside the range of the base station, you will get an unreliable picture or no picture at all. Please check the signal strength icon in the live image to see if it is sufficient. At least 2 bars should be displayed.

Place the base station as close as possible to the camera to get the best possible picture. The following factors can negatively influence transmission: thick brick walls, exterior walls, glass, water pipes and metal.

Camera image is not displayed

Check the signal strength in the live view.

Check the battery charge level in the camera settings.

Is the camera connected to the base station?

Is there an internet connection?

<https://support.abus-sc.com/knowledge-base/warum-zeigt-die-app-kein-livebild-an>

Push notifications are not received

Is the camera deactivated? Also check the schedules.

Are the push notifications deactivated?

Is there an internet connection?

Is the base station unplugged?

Is the permission for the app active in the settings of the mobile phone/tablet?

<https://support.abus-sc.com/knowledge-base/warum-bekomme-ich-keine-push-nachrichten>

How can I reset my base station to factory settings?

Press the reset button on the back of the base station for at least 5 seconds using the reset tool or a paper clip, for example. The power LED on the top starts flashing red. As soon as the factory settings are loaded and the base station is ready for setup, the power LED lights up red continuously.

The base station is not found

Please check the following points:

1. Make sure that your network supports DHCP.
2. Are the mobile device and the base station in the same network? Make sure that both devices are in the same network for initial configuration.
3. The router has no power supply.
4. The base station has no power supply.
5. Try adding the camera by manually entering the data.

Weak network signal or poor image quality

Possible causes could be:

1. Wi-Fi devices can interfere with signal transmission; ensure sufficient distance between the base station, camera and Wi-Fi devices.
Possible interfering factors can also be: thick brick walls, exterior walls, glass, water pipes and metal.
2. Remove dirt from the camera. This can negatively influence the transmission and picture quality.

What could be the causes for the device not recording when there is movement?

Possible causes could be:

1. Is a USB storage medium plugged in and recognised by the system? (Disconnect the base from the power supply, insert the USB stick, reconnect the base to the power supply)
2. Is the camera activated?
3. Are the schedules set correctly?
4. Format USB stick (see instructions in this manual)
5. Check the sensitivity of the PIR in the camera settings; it may be set too low.

The camera image is overexposed (white areas in the image).

The camera has a white light LED for night operation. The light is reflected on reflective surfaces such as glass or white surfaces. Do not place the camera in front of glass surfaces and make sure to install the camera in an outdoor area protected from direct sunlight if possible.

The time and date display is not correct.

Possible causes could be:

1. Are the date and time settings on your mobile device set correctly? The system takes the time from your mobile device.
2. Is the correct time zone selected?
3. Restart the base station by disconnecting it from the power supply and plugging it back in after approx. 5 seconds.

9. Open Source licence notes

The product contains software components that are licensed by the rights holders as free software or open source software (hereinafter referred to as "OSS"). The corresponding licences are enclosed with the product in printed form and/or can be accessed via a graphical user interface. You can acquire usage rights to the extent regulated therein directly from the rights holders.

The open source licences take precedence over all other licence conditions and contractual agreements with ABUS in respect of the corresponding OSS software components contained in the product.

In general, licence information for ABUS products can be found at www.abus.com in the download area of the product description.