

Features

- Wide range input: 85-264VAC
- Operating temperature from -40°C to +90°C
- OVC III and LPS rated
- 2MOPP medical certified, B and BF compliant
- 4000m operating altitude
- Class B EMC filter built-in

Regulated Converter



RACM90-K

90 Watt

2" x 4"



Open Frame & Enclosed Single Output

Description

The RACM90-K AC/DC power supply series provides 90W output and is Limited Power Source (LPS)-rated according to safety standards for medical, ITE, industrial and household markets. With an industry-standard 2"x4" footprint, variants are available as an open card or with an enclosure. Input is wide-range for nominals from 100 to 240Vac, the output is tightly regulated and easy system integration is enabled by a wide compliance margin to EMC standard EN55032 class B. On-board dual fuses are included and the product includes immunity to surges for installation class 3 and over-voltage category OVCIII. Certifications are maintained to 4000m altitude and with a wide operating temperature range, the series is one of the most versatile on the market.

Selection Guide

Part Number	Input Voltage Range [VAC]	nom. Output Voltage [VDC]	Output Current [A]	Output Power [W]	Efficiency typ. ⁽¹⁾ [%]
RACM90-12SK ⁽²⁾	85-264	12	7.5	90	87
RACM90-15SK ⁽²⁾	85-264	15	6	90	89
RACM90-24SK ⁽²⁾	85-264	24	3.75	90	89
RACM90-36SK ⁽²⁾	85-264	36	2.5	90	90
RACM90-48SK ⁽²⁾	85-264	48	1.87	90	90

Notes:

Note1: Efficiency is tested at nominal input and full load at +25°C ambient

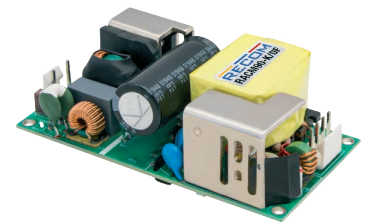

2MOPP 250VAC

- ANSI/AAMI ES60601-1 Ed. 3.1 certified
- CSA/CAN-C22.2 No. 60601-1:14 certified
- IEC/EN60601-1 certified
- IEC/EN62368-1 (pending)
- IEC/EN60335-1 (pending)
- IEC/EN61558-2-16 (pending)
- IEC/EN61558-1 (pending)
- EN55032 compliant
- EN55035 compliant

Model Numbering



Notes:

Note2: "/OF" = standard 2"x4" open frame version
 "/ENC" = standard enclosed version

Ordering Examples:

RACM90-12SK/OF	12Vout	Single	open frame	2" x 4"
RACM90-15SK/ENC	15Vout	Single	enclosed	2.4" x 4.6"

Specifications (measured @ Ta= 25°C, nom. Vin, full load and after warm-up unless otherwise stated)

BASIC CHARACTERISTICS

Parameter	Condition	Min.	Typ.	Max.
Nom. Input Voltage	60Hz	90VAC		
	50Hz			240VAC
Operating Range ⁽⁴⁾	47-63Hz	85VAC		264VAC
	DC	120VDC		370VDC
Input Current	115VAC			2A
	230VAC			1.2A
Inrush Current	cold start	115VAC		30A
		230VAC		40A
No load Power Consumption	@230VAC		200mW	
ErP Standby Mode Conformity (Output Load Capability)	115/230VAC	P _{IN} = 0.5W	0.2W	
		P _{IN} = 1W	0.6W	
Input Frequency Range	AC Input	47Hz		63Hz
Minimum Load		0%		
Power Factor	115VAC		0.5	
	230VAC		0.4	
Start-up Time			150ms	
Rise Time			25ms	
Hold-up Time	115VAC		12ms	
	230VAC		70ms	
Internal Operating Frequency	100% load at nominal Vin		65kHz	
Output Ripple and Noise ⁽⁵⁾	20MHz BW			1% of Vout

Notes:

Note4: The products were submitted for safety files at AC-Input operation

Note5: Measurements are made with a 0.1µF MLCC & 10µF E-cap in parallel across output. (low ESR)

Efficiency vs. Load

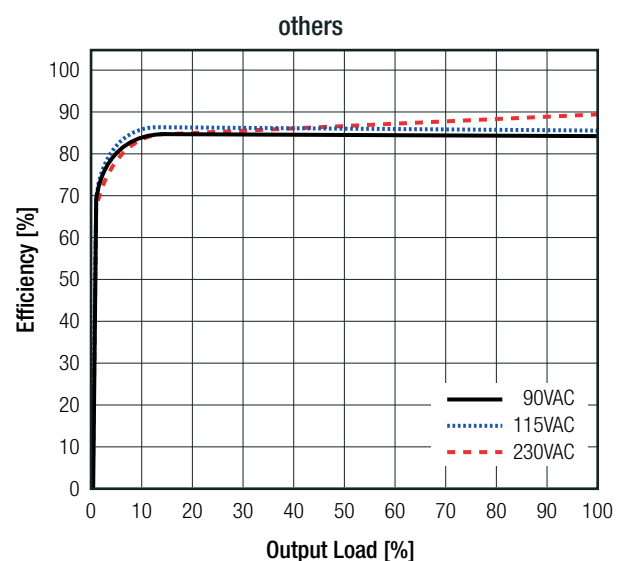
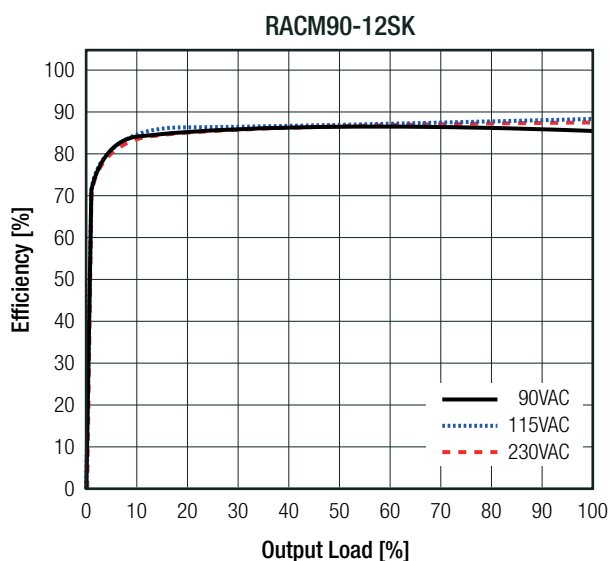

continued on next page

Specifications (measured @ Ta= 25°C, nom. Vin, full load and after warm-up unless otherwise stated)

REGULATIONS		
Parameter	Condition	Value
Output Accuracy		±2.0% typ.
Line Regulation	low line to high line, full load	±0.5% typ.
Load Regulation ⁽⁶⁾	10% to 100% load	1.0% typ.
Transient Response	25% load step change	4.0% max.
	recovery time	500µs max.

Notes:

Note6: Operation below 10% load will not harm the converter, but specifications may not be met

Deviation vs. Load
(@ 115-230VAC)

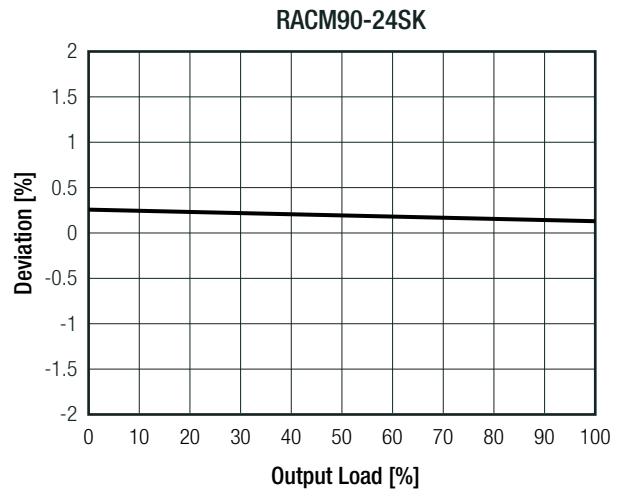
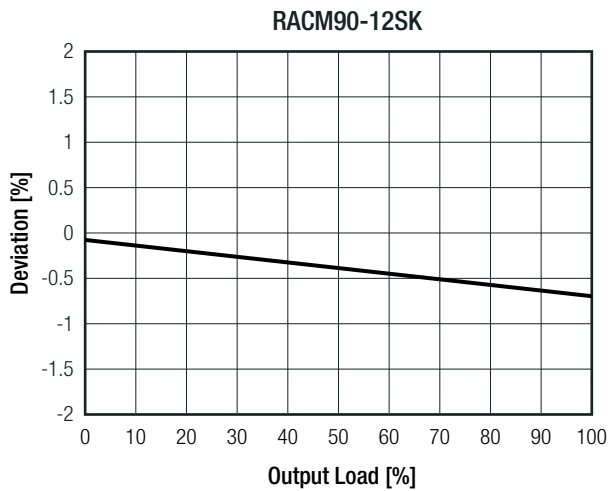

PROTECTIONS			
Parameter	Type	Value	
Internal Input Fuse	L and N (dual fusing)	T4A, slow blow type	
Short Circuit Protection (SCP)		hiccup, auto recovery	
Over Voltage Protection (OVP)		130% - 150%, hiccup mode	
Over Voltage Category	according to 61558-2-16	OVCIII (up to 2000m)	
	according to 60601-1	OVCII	
Over Current Protection (OCP)		130% - 150%, hiccup mode	
Isolation Voltage ⁽⁷⁾	I/P to O/P	1 minute	4kVAC
Isolation Resistance	I/P to O/P, V _{iso} = 500VDC		1GΩ min.
Isolation Capacitance	I/P to O/P, 100kHz/0.1V		100pF max.
Touch Current	264VAC/63Hz	NC	<100µA
		SFC	<500µA
Insulation Grade		reinforced	
Means of Protection	≤300Vrms working voltage	2MOPP	

Notes:
Note7: For repeat Hi-Pot testing, reduce the time and/or the test voltage

Specifications (measured @ $T_a = 25^\circ\text{C}$, nom. V_{in} , full load and after warm-up unless otherwise stated)

ENVIRONMENTAL

Parameter	Condition		Value
Operating Temperature Range	with derating @ natural convection 0.1m/s		-40°C to $+90^\circ\text{C}$
Operating Altitude	according to 60601-1		4000m (OVCI)
	according to 61558-2-16		2000m (OVCI)
Temperature Coefficient			$\pm 0.05\%/K$
Operating Humidity	non-condensing		5% - 95% RH max.
Pollution Degree			PD2
Vibration	according to MIL-STD-202G		10-500Hz, 2G 10min./1cycle, period 60min. along x,y,z axes
MTBF	according to MIL-HDBK-217F, G.B.	$T_{AMB} = +25^\circ\text{C}$	776×10^3 hours
		$T_{AMB} = +40^\circ\text{C}$	668×10^3 hours
Design Lifetime	$T_{AMB} = +45^\circ\text{C}$	12/15Vout	26×10^3 hours
	$T_{AMB} = +50^\circ\text{C}$	26/36/48Vout	

Thermal Rating

(@ natural convection 0.1m/s)

RACM90-K/OF

100VAC

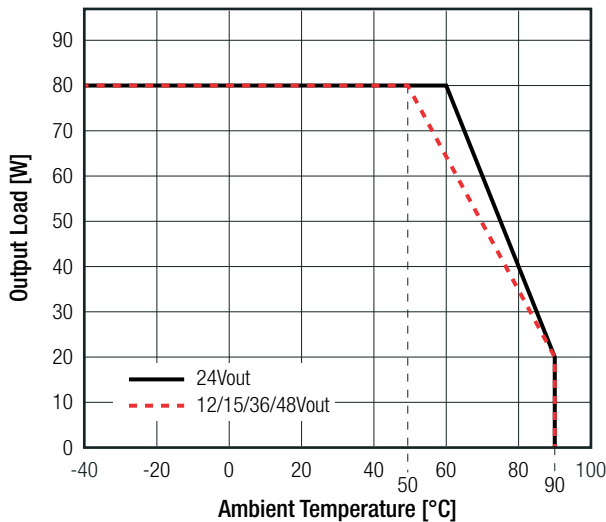

120-240VAC

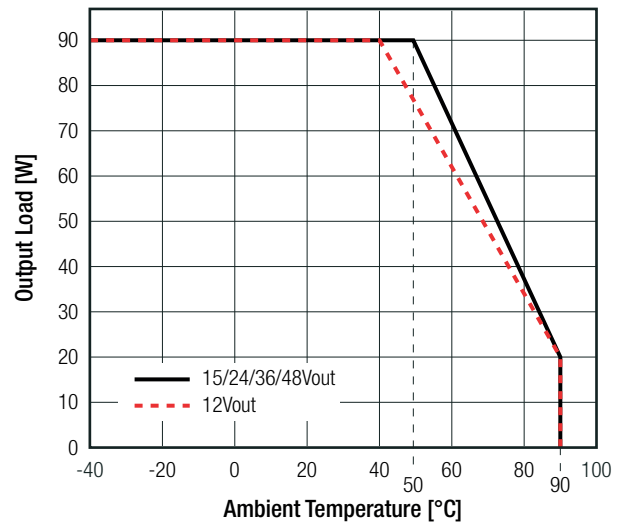

RACM90-K/ENC

100VAC

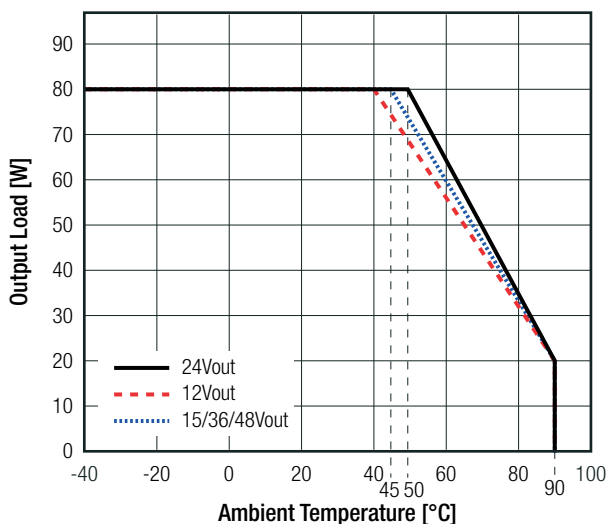

120-240VAC

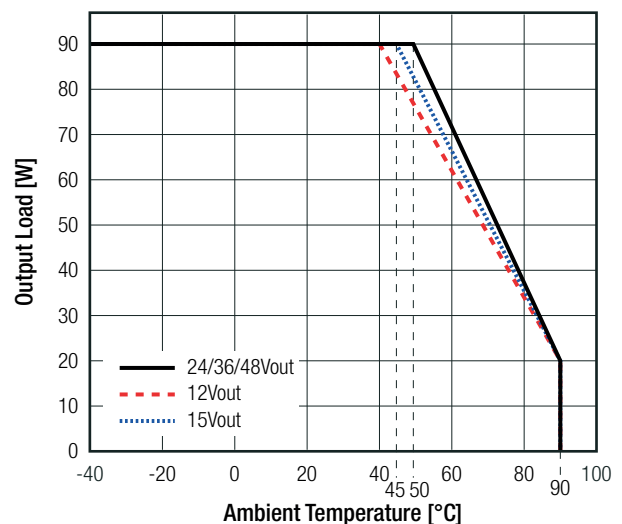

Specifications (measured @ Ta= 25°C, nom. Vin, full load and after warm-up unless otherwise stated)

SAFETY AND CERTIFICATIONS		
Certificate Type (Safety)	Report Number	Standard
Medical electrical equipment Part 1: General requirements for basic safety and essential performance	E511305-D1002-1/A0/C0-UL	CAN/CSA-C22.2 No. 60601-1-14, 3rd Edition ANSI/AAMI ES60601-1:2005 + A2:2010
Medical electrical equipment Part 1: General requirements for basic safety and essential performance		IEC60601-1:2005 + AM1:2012, 3rd Edition EN60601-1:2006 + A12:2014
Audio/Video, information and communication technology equipment - Safety requirements (CB Scheme)	pending	IEC62368-1:2014
Audio/Video, information and communication technology equipment - Safety requirements (LVD)	pending	EN62368-1:2014
Audio/Video, information and communication technology equipment - Part1: Safety requirements		EN IEC 62368-1:2020
Household and similar electrical appliances – Safety – Part 1: General requirements (LVD)	pending	IEC60335-1:2010 EN60335-1:2012
Safety of power transformers, power supplies, reactors & similar products for supply voltages up to 1100 V Part 2: Particular requirements (CB Scheme)	pending	IEC61558-2-16:2009
Safety of power transformers, power supplies, reactors & similar products for supply voltages up to 1100 V Part 2: Particular requirements	pending	EN61558-2-16:2009
Safety of power transformers, power supplies, reactors and similar products for supply voltages up to 1100 V (CB Scheme)	pending	IEC61558-1:2017
		EN IEC 61558-1:2019
RoHS2		RoHS 2011/65/EU + AM2015/863
EMC Compliance (EN61204-3)	Condition	Standard / Criterion
Low voltage power supplies, d.c. output Part 3: Electromagnetic compatibility	JYTAB-R01-2100249	EN/IEC61204-3:2018
ESD Electrostatic discharge immunity test	Contact: ±4kV	EN61000-4-2:2009, Criteria B
Radiated, radio-frequency, electromagnetic field immunity test	10V/m (80-1000MHz) 3V/m (1400-2000MHz) 1V/m (2000-2700MHz)	EN61000-4-3:2006, Criteria A
Fast Transient and Burst Immunity	AC Port: L-N 2kV	EN61000-4-4:2012, Criteria A
Surge Immunity	AC Port: L-N 0,5, 1kV	EN61000-4-5:2014, Criteria A
Immunity to conducted disturbances, induced by radio-frequency fields	AC Port: 10Vrms (0.15-80MHz)	EN61000-4-6:2014, Criteria A
Power Magnetic Field Immunity	30A/m	EN61000-4-8:2010; Criteria A
Voltage Dips and Interruptions	Dips: 100% (0.5, 1.0P), 30%, 20% 60% Interruptions: 100%	EN61000-4-11:2004, Criteria A
		EN61000-4-11:2004, Criteria B EN61000-4-11:2004, Criteria B
Limits of Voltage Fluctuations & Flicker		EN61000-3-3:2013
EMC Compliance (EN55032)	Condition	Standard / Criterion
Electromagnetic compatibility of multimedia equipment - Emission requirements	JYTAB-R01-2100250	EN55032:2015
Electromagnetic compatibility of multimedia equipment - Immunity requirements		EN55035:2017
ESD Electrostatic discharge immunity test	Contact: ±2, 4kV	EN61000-4-2:2009, Criteria B
Radiated, radio-frequency, electromagnetic field immunity test	3 V/m (80-5000MHz)	EN61000-4-3:2006+A2:2010, Criteria A
Fast Transient and Burst Immunity	AC Port: L-N 1kV	EN61000-4-4:2012, Criteria A
Surge Immunity	AC Port: L-N 0,5, 1kV	EN61000-4-5:2014, Criteria A
Immunity to conducted disturbances, induced by radio-frequency fields	AC Port: 3Vrms (0.15-10MHz) 3-1Vrms (10-30MHz) 1Vrms (30-80MHz)	EN61000-4-6:2014, Criteria A
Power Magnetic Field Immunity	1A/m	EN61000-4-8:2010, Criteria A
Voltage Dips and Interruptions	Dips: 100%, 30% Interruptions:100%	EN61000-4-11:2004 , Criteria A
		EN61000-4-11:2004, Criteria B
Limits of Harmonic Current Emissions		EN61000-3-2:2014
Limits of Voltage Fluctuations & Flicker		EN61000-3-3:2013

Specifications (measured @ Ta= 25°C, nom. Vin, full load and after warm-up unless otherwise stated)

DIMENSION AND PHYSICAL CHARACTERISTICS		
Parameter	Type	Value
Material	PCB	FR4, (UL94-V0)
	baseplate / case ("/ENC)	aluminum
Dimension (LxWxH)	"/OF" Version	101.6 x 50.8 x 32.0mm
	"/ENC" Version	118.3 x 62.7 x 38.7mm
Weight	"/OF" Version	180g typ.
	"/ENC" Version	265g typ.

Dimension Drawing "/OF"(mm)

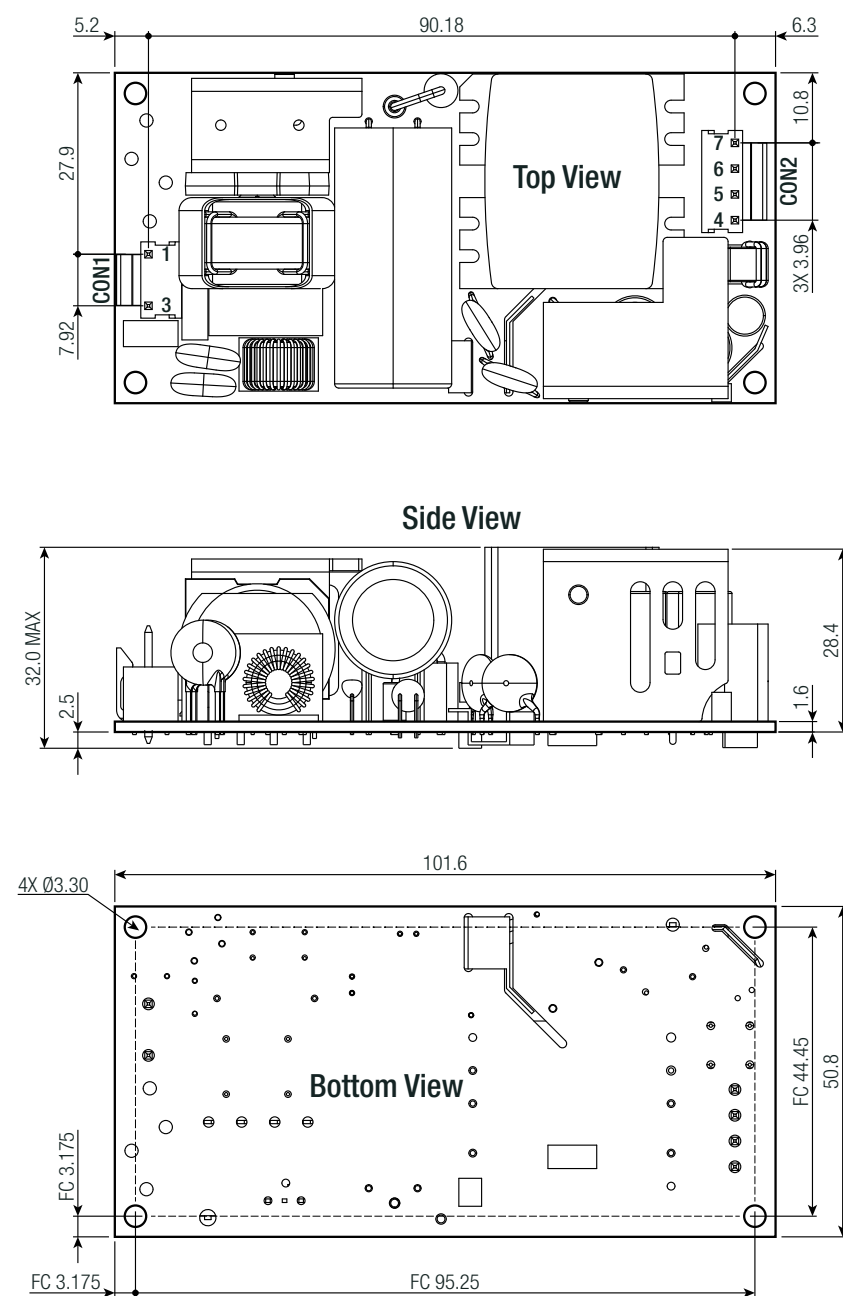

AC Input Side View

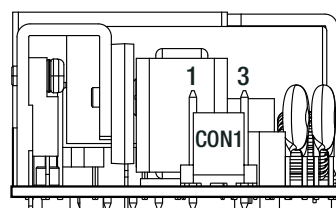

DC Output Side View

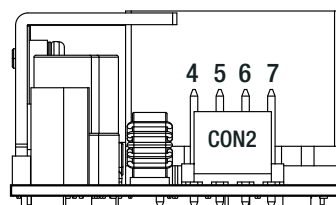

Connector Information

#	Function	Terminal
AC Input (CON1)		
1	VAC in (N)	3 Pins (Pin2 removed)
3	VAC in (L)	with 3.96mm pitch
DC Output (CON2)		
4,5	+VDC out	4 Pins
6,7	-VDC out	with 3.96mm pitch

FC= fixing centers

Compatible Connector

Housing

Molex 41695 Series or equivalent

Crimp Terminal

Molex 2478 Series or equivalent

Tolerances: xx.x= ±0.5mm
xx.xx= ±0.25mm

continued on next page

Specifications (measured @ Ta= 25°C, nom. Vin, full load and after warm-up unless otherwise stated)

Dimension Drawing "/ENC"(mm)

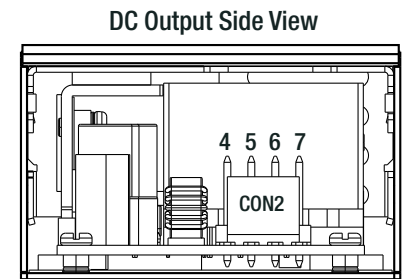
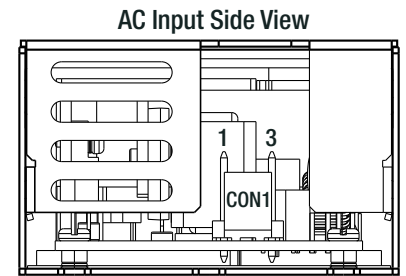
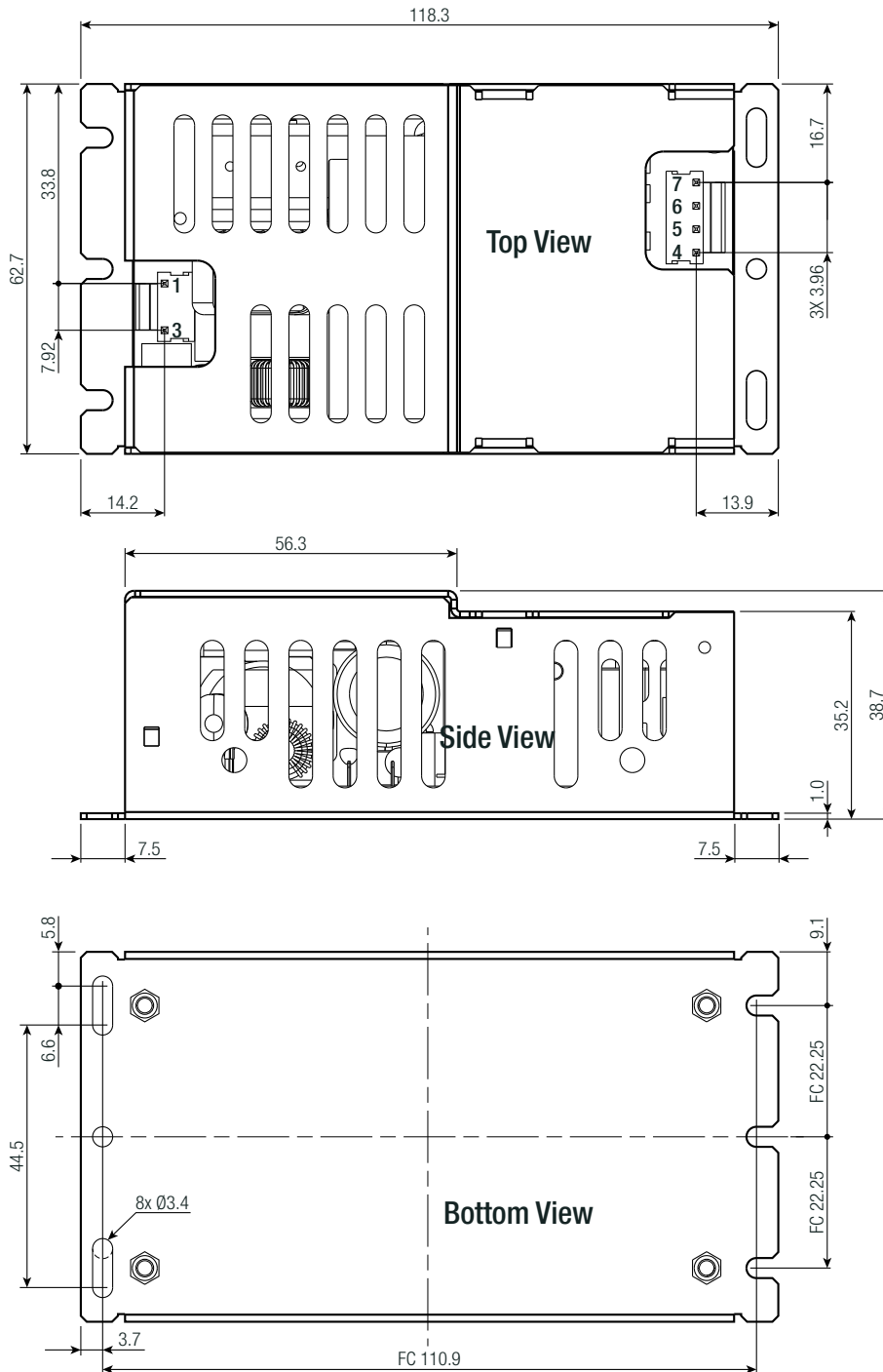

Connector Information

#	Function	Terminal
AC Input (CON1)		
1	VAC in (N)	3 Pins (Pin2 removed)
3	VAC in (L)	with 3.96mm pitch
DC Output (CON2)		
4,5	+VDC out	4 Pins
6,7	-VDC out	with 3.96mm pitch

FC= fixing centers

Compatible Connector

Housing

Molex 41695 Series or equivalent

Crimp Terminal

Molex 2478 Series or equivalent

Tolerances: xx.x= ±0.5mm
xx.xx= ±0.25mm

Specifications (measured @ Ta= 25°C, nom. Vin, full load and after warm-up unless otherwise stated)

APPLICATION AND INSTALLATION

Mounting

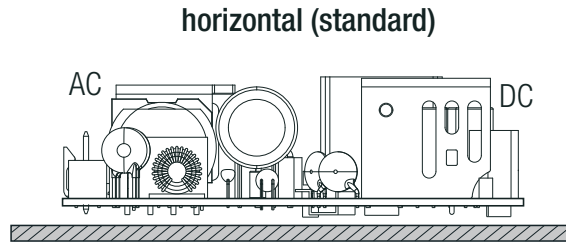
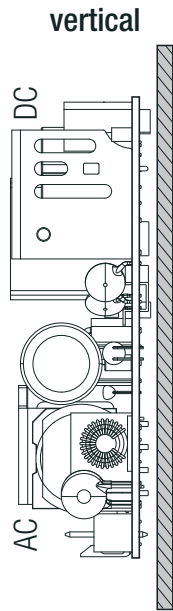

If module is mounted vertical or upside-down with natural convection cooling, the power must be derated $\geq 10\%$.

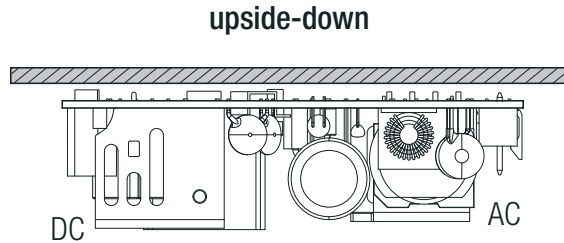

Blockdiagram ("OF")

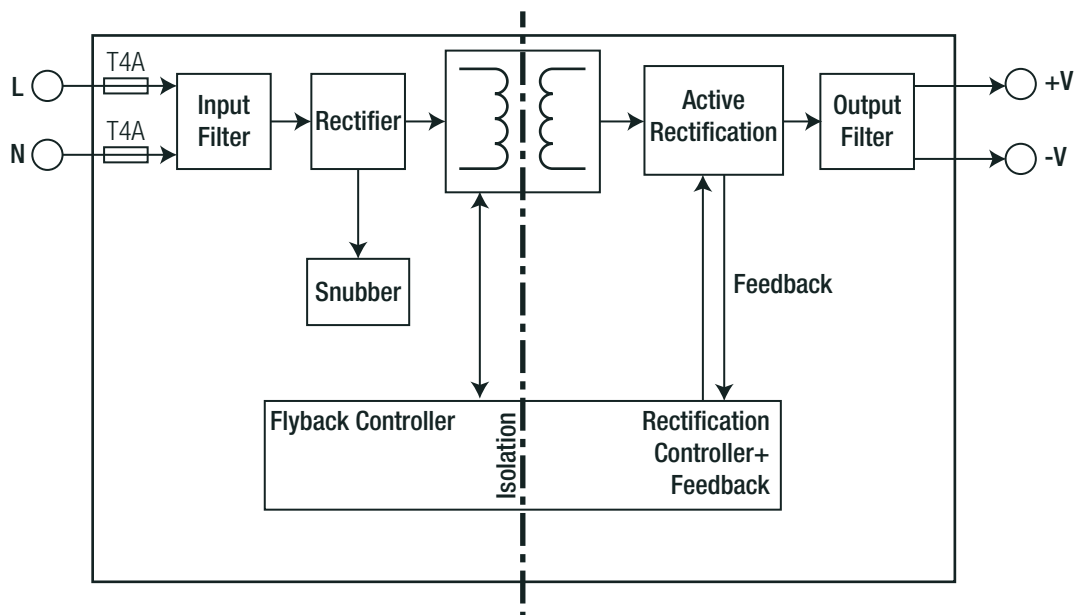

continued on next page

Specifications (measured @ Ta= 25°C, nom. Vin, full load and after warm-up unless otherwise stated)

APPLICATION AND INSTALLATION

Blockdiagram (“/ENC”)

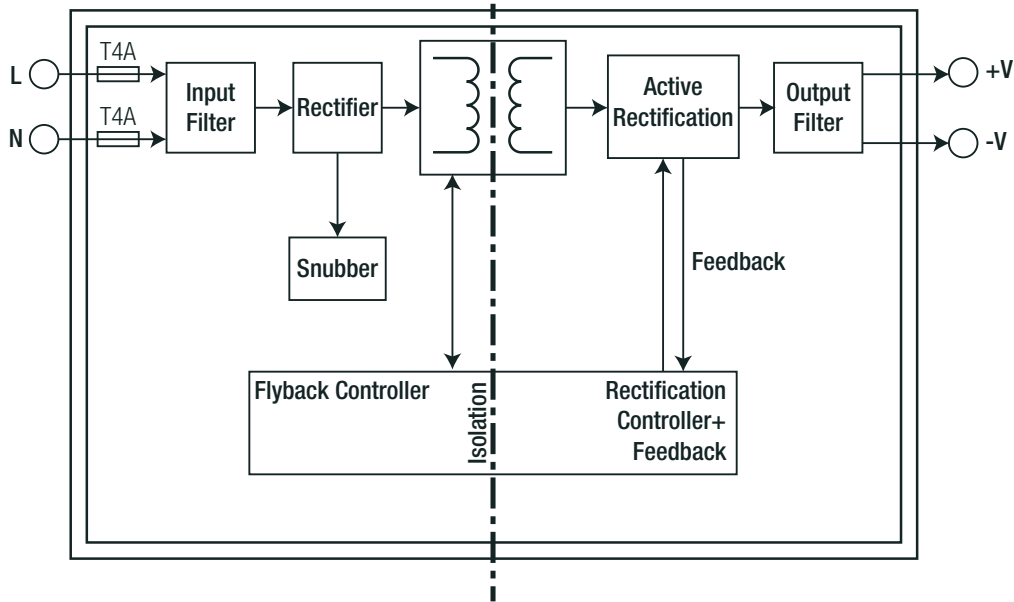

PACKAGING INFORMATION

Parameter	Type		Value
	Packaging Dimension (LxWxH)	"/OF" type	
"/ENC" type		435.0 x 370.0 x 94.0mm	
Packaging Quantity	"/OF" type		9pcs
	"/ENC" type		18pcs
Storage Temperature Range			-40°C to +90°C
Storage Humidity	non-condensing		95% max.

The product information and specifications may be subject to changes even without prior written notice. The product has been designed for various applications; its suitability lies in the responsibility of each customer. The products are not authorized for use in safety-critical applications without RECOM's explicit written consent. A safety-critical application is an application where a failure may reasonably be expected to endanger or cause loss of life, inflict bodily harm or damage property. The applicant shall indemnify and hold harmless RECOM, its affiliated companies and its representatives against any damage claims in connection with the unauthorized use of RECOM products in such safety-critical applications.