



SmartOTDR Mainframe Handheld Fiber Tester

User Manual

SmartOTDR Mainframe Handheld Fiber Tester

User Manual



VIAVI Solutions
1-844-GO-VIAVI
www.viavisolutions.com

Notice

Every effort was made to ensure that the information in this document was accurate at the time of printing. However, information is subject to change without notice, and VIAVI reserves the right to provide an addendum to this document with information not available at the time that this document was created.

Copyright

© Copyright 2023 VIAVI Solutions Inc. All rights reserved. No part of this guide may be reproduced or transmitted, electronically or otherwise, without written permission of the publisher. VIAVI Solutions and the VIAVI logo are trademarks of VIAVI Solutions Inc. (“Viavi”).

The Bluetooth® word mark and logos are registered trademarks owned by Bluetooth SIG, Inc. and any use of such marks by VIAVI is under license.

All other trademarks and registered trademarks are the property of their respective owners.

Patented as described at www.viavisolutions.com/patents.

Open source disclaimer - IMPORTANT READ CAREFULLY

This product includes third party software licensed under the terms of separate open source software licenses. By using this software you agree to comply with the terms and conditions of the applicable open source software licenses. Software originated by VIAVI is not subject to third party licenses. Terms of the VIAVI Software License different from applicable third party licenses are offered by VIAVI alone.

EU WEEE and Battery Directives

This product, and the batteries used to power the product, should not be disposed of as unsorted municipal waste, and should be collected separately and disposed of according to your national regulations.

VIAVI has established a take-back processes in compliance with the EU Waste Electrical and Electronic Equipment (WEEE) Directive, 2012/19/EU, and the EU Battery Directive, 2006/66/EC.

Instructions for returning waste equipment and batteries to VIAVI can be found in the WEEE section of [VIAVI's Standards and Policies web page](#).

If you have questions concerning disposal of your equipment or batteries, contact the VIAVI WEEE Program Management team at WEEE.EMEA@VIASolutions.com.



Table of Contents

About This Guide	xiii
Purpose and scope	xiv
Assumptions	xiv
Technical assistance	xiv
Conventions	xiv
Chapter 1 Safety information	1
Battery and AC/DC safety information	2
Optical Connectors Handling Precaution	3
Laser Safety instructions	3
Laser classes	3
Warning labels for the laser classes	4
Chapter 2 Introducing the SmartOTDR	5
Unpacking the SmartOTDR	6
Hard keys and Indicators	8
Front panel hard keys	8
Front panel LED indicators	9
Power Supply	9
Chapter 3 Starting up	11
Setting the adaptable plug to the mains adapter	12
Charging the battery	13
Connecting the mains adapter	13

First use of the battery	14
Charging the Li-Po battery	14
Battery charge level display	14
Turning the SmartOTDR on and off	15
Turning on the unit	15
Turning off the unit	15
Built-in kickstand	16
First startup: configuring the regional settings	17
Chapter 4 Setting-up the SmartOTDR	19
Displaying the System Settings screen	20
Configuring screen and display settings	21
Backlight	21
Screen Saver	21
Defining the Automatic shutdown and the storage limit	22
Automatic shutdown	22
Storage Limit	22
Chapter 5 Optical options	23
Optical Power Meter and Light Source Functions	24
Built-in Visual Fault Locator (VFL) Function	24
VFL connector	24
Using the built-in VFL	24
Chapter 6 Microscope application	27
Microscope Overview	28
Connecting the microscope	29
P5000i probe USB connection	29
FiberChek probe WIFI connection	29
FiberChek probe USB Connection	30
Configuring the microscope	31
Test Setup	31
Link Description	34
File configuration	36
Tip and Profile Management	38
Using the microscope	40
Running an automated test	40

Viewing prior images (Mosaic Mode)	42
Accessing online help	43
Chapter 7 Connectivity	45
Establishing connection	46
Checking Bluetooth/WIFI option is installed	46
Via Bluetooth	46
Pairing the Platform with a device	46
Searching new devices to be paired with the Platform	48
Removing the Pairing	49
Via Wifi	50
Configuring the WiFi access	50
Connection to SSID	51
Configuring the WiFi mode to which the Platform is connected	52
Creating a network from the SmartOTDR	53
Via Ethernet	53
Connecting the SmartOTDR and the PC	53
Configuring the SmartOTDR via Ethernet	54
Via Cloud Storage	56
Principle and prerequisites of the Cloud Storage	56
Configuring and connecting to Cloud Storage on the SmartOTDR	57
Remote Control	59
Smart Access Anywhere	59
Connection modes	59
Pre-requisite for using the Smart Access Anywhere Application	61
Downloading the VIAVI application on PC	61
Downloading the VIAVI application on Tablet/Smartphone	63
Launching the SmartAccess Anywhere application	63
Using Remote screen and File Transfer applications	65
Working with files and directories on SmartOTDR	69
Connection information and settings	69
Data Transfer	73
Transferring files via Bluetooth	73
Transferring files to/from a PC via WIFI or Ethernet	74
Transferring files using Cloud Storage	75
VNC	76
Transferring the interface on a PC via WIFI or Ethernet	76
Virtual control buttons bar	77
Equivalence between the keyboard and SmartOTDR	78
Stratasync	79
Principle and prerequisites of the Stratasync	79
Configuring and synchronizing the SmartOTDR	80

Connecting the SmartOTDR to Stratasync	81
Chapter 8 File management	83
File Explorer Overview	84
Directories and Files selections	84
Directory selection	84
Files selection	85
Directories & Files editing functions	86
Copy/Cut & Paste files/directories	86
Renaming a directory / file	86
Deleting a directory / file	87
Working with directories and files from the explorer	87
Creating a directory	87
Opening files	87
File Types	88
Sorting files	88
Creating a screenshot	89
Taking a screenshot	89
Name of the screenshots files	89
Merging pdf or txt files	90
Storage media	91
Storage media built into the SmartOTDR	92
External USB storage media	92
USB memory stick connection	92
USB memory stick disconnection	92
Abbreviations for storage media	93
Chapter 9 Technical specifications	95
General specifications	96
Display specifications	96
Memory	96
Input/Output	96
Battery	96
Mains adapters	97
Dimensions - Weight	97

Environment.....	98
Temperature.....	98
Humidity.....	98
EMI/ESD.....	98
Drop test.....	98
Shocks.....	98
Bumps.....	98
Vibration.....	99
Flammability.....	99
Characteristics of the Source (standard) and Power Meter (optional)	99
Source.....	99
Broadband power Meter (through non-filtered OTDR port).....	99
Dual-Band Power Meter (through filtered OTDR port) - 118FA65PPM version only.....	100
Characteristics of the options.....	100
VFL.....	100
Bluetooth and WIFI.....	101
Characteristics of the OTDR.....	101
OTDR Optical Interfaces.....	101
OTDR Optical characteristics.....	101
Characteristics of reflectometry measurements.....	101
Manual Measurement.....	102
Typical specifications.....	103
Chapter 10 Options and accessories	105
Ordering Information.....	106
Chapter 11 Maintenance and Troubleshooting	109
Maintenance procedure.....	110
Cleaning.....	110
Cleaning plates and housings.....	110
Cleaning the screen.....	110
Cleaning the optical cable connector.....	111
Cleaning the optical connections of the SmartOTDR.....	111
Accessing to the SmartOTDR information.....	111
General page.....	111
Software options page.....	112
Services Data page.....	113
Accessing to the Platform documentation.....	113

Installing a new version of the software	114
Downloading from Internet	114
Installation from VIAVI Server	114
Installation from another server	116
Installation from a USB memory stick	116
Launching the upgrade	118
Checking new upgrade on VIAVI Server	118
Upgrading from the boot	119
Install Software License	120
Install options from VIAVI Server	121
Enter Manually the License	121
Import the license from the USB memory stick	122
Locking the SmartOTDR	123
Sending equipment to VIAVI for calibration, maintenance, or repair .	125
Guarantee conditions	125
Recycling Information	125
Troubleshooting	126
Interpreting alarms	126
Formatting the USB memory stick onto the SmartOTDR	127
Erase disk	127
Touchscreen calibration («Autotune» process for capacitive touchscreen)	128
Replacing the battery	129
Accessing to the battery	129
Installing a new battery	129
Installing the Bluetooth/WIFI option	131
General information on warranty	132
Hardware Warranty	132
Warranty disclaimer	133

Index

135



About This Guide

VIAVI SmartOTDR is an handheld OTDR designed for the construction, turn-up and maintenance of fiber networks.

The topics discussed in this chapter are as follows:

- [“Purpose and scope” on page xiv](#)
- [“Assumptions” on page xiv](#)
- [“Technical assistance” on page xiv](#)
- [“Conventions” on page xiv](#)

Purpose and scope

The purpose of this guide is to help you successfully use the SmartOTDR features and capabilities. This guide includes task-based instructions that describe how to install, configure, use, and troubleshoot the SmartOTDR.

Additionally, this guide provides a complete description of VIAVI's warranty, services, and repair information, including terms and conditions of the licensing agreement.

Assumptions

This guide is intended for novice, intermediate, and experienced users who want to use the SmartOTDR effectively and efficiently. We are assuming that you have basic computer and mouse/track ball experience and are familiar with basic telecommunication concepts and terminology.

Technical assistance

If you require technical assistance, call 1-844-GO-VIAVI. For the latest TAC information, go to <http://www.viavisolutions.com/en/services-and-support/support/technical-assistance>.

Conventions

This guide uses naming conventions and symbols, as described in the following tables.

Table 1 Typographical conventions

Description	Example
User interface actions appear in this typeface .	On the Status bar, click Start .
Buttons or switches that you press on a unit appear in this TYPEFACE .	Press the ON switch.

Table 1 Typographical conventions

Description	Example
Code and output messages appear in this <i>typeface</i> .	All results okay
Text you must type exactly as shown appears in this <i>typeface</i> .	Type: a:\set.exe in the dialog box
Variables appear in this <i>typeface</i> .	Type the new <i>hostname</i>
Book references appear in this <i>typeface</i> .	Refer to <i>Newton's Telecom Dictionary</i>
A vertical bar means "or": only one option can appear in a single command.	platform [a b e]
Square brackets [] indicate an optional argument.	login [platform name]
Slanted brackets < > group required arguments.	<password>

Table 2 Keyboard and menu conventions

Description	Example
A plus sign + indicates simultaneous keystrokes.	Press Ctrl+s
A comma indicates consecutive key strokes.	Press Alt+f,s
A slanted bracket indicates choosing a submenu from menu.	On the menu bar, click Start > Program Files.

Table 3 Symbol conventions



This symbol represents a general hazard.



This symbol represents a risk of electrical shock.



NOTE

This symbol represents a Note indicating related information or tip.



This symbol, located on the equipment or its packaging indicates that the equipment must not be disposed of in a land-fill site or as municipal waste, and should be disposed of according to your national regulations.

Table 4 Safety definitions



WARNING

Indicates a potentially hazardous situation which, if not avoided, could result in death or serious injury.



CAUTION

Indicates a potentially hazardous situation which, if not avoided, may result in minor or moderate injury.

Safety information

This chapter gives the main information on the safety conditions when using the SmartOTDR:

- [“Battery and AC/DC safety information” on page 2](#)
- [“Optical Connectors Handling Precaution” on page 3](#)
- [“Laser Safety instructions” on page 3](#)

Battery and AC/DC safety information

Lithium-Polymer (Li-Po) battery

- The Li-Po battery is designed for maximum safety.

In particular, each cell is provided with a safety valve to prevent excessive internal pressure in the event of overcharging or exposure to very high temperatures.

General precautions

- Do not use any mains adaptor or battery other than those supplied with the unit, or supplied by VIAVI as an option for this unit.
If another adapter or battery is used, it may damage the SmartOTDR itself. Using the SmartOTDR with a battery other than the one supplied by the manufacturer of the SmartOTDR may entail risks of fire or explosion.
The battery may explode, leak or catch fire:
 - if it is exposed to high temperature or fire
 - if it is opened or dismantled.
- If you do not intend to use the unit for several weeks, it is advisable to remove the battery in order to prolong its useful life, and to recharge it fully before using it again.
- In case of communication problems with the battery, informed to the user, the battery charging information is no more actualized.
Restart the equipment to restore the communication with battery.

Other basic safety precautions are as follows:

- Do not use AC/Adapter/Charger outdoors or in wet or damp locations
- Connect the AC/Adapter/Charger to the correct mains voltage, as indicated on the ratings label.
- Do not allow anything to rest on the power cord, and do not locate the product where people can walk on the power cord.
- Avoid using this product during an electrical storm. There may be a remote risk of electric shock from lightning.
- Do not use this product in the vicinity of a gas leak or in any explosive environment.

- Do not attempt to service this product yourself, as opening or removing covers may expose you to dangerous, high voltage points and other hazards. Contact qualified service personnel for all service.

Optical Connectors Handling Precaution

- Typical optical connectors are rated for 500 mating cycles. Limiting the number of connections will prolong the OTDR connector's lifetime.
- To ensure accurate and repeatable OTDR measurements, OTDR's optical connector must be cleaned and in good condition.
- SmartOTDR's protective cover primary purpose is to protect the optical connector ferrule end face from scratch and pitting defects. It does not protect the ferrule end face from dust contamination. We strongly recommend inspecting the OTDR optical connector with a fiber inspection probe before using it and clean it if necessary.

Laser Safety instructions

The provisions contained in two standards define the safety procedures to be observed both by users and by manufacturers when utilizing laser products:

- IEC 60825-1: 2014 - Safety of laser products – Part 1: Classification of products, requirements and user guidelines.
- FDA 21 CFR § 1040.10 - Performance standards for light-emitting products - Laser products.

Due to the range of possible wavelengths, power values and injection characteristics of a laser beam, the risks inherent in its usage vary. The laser classes form groups representing different safety thresholds.





Laser classes

Standards IEC 60825-1: 2014 and FDA21CFR§1040.10:

- VFL option: Class 2.

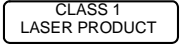
Warning labels for the laser classes

Due to the reduced dimensions of the optical modules, it is not possible to attach the required warning labels to them. In line with the provisions of Article 7.1 of the IEC 60825-1: 2014 standard, the laser class identification labels are shown below:

Reference standard	IEC 60825-1: 2014	FDA21CFR§1040.10
Class 1	 A white rectangular label with a black border containing the text: CLASS 1 LASER PRODUCT	
Class 1M	 A yellow rectangular label with a black border containing the text: LASER RADIATION DO NOT VIEW DIRECTLY WITH OPTICAL INSTRUMENTS CLASS 1M LASER PRODUCT	
Class 2	 A yellow rectangular label with a black border containing the text: LASER RADIATION DO NOT STARE INTO BEAM CLASS 2 LASER PRODUCT	 A yellow rectangular label with a black border containing the text: CAUTION LASER RADIATION - DO NOT STARE INTO BEAM CLASS II LASER PRODUCT and a sunburst icon.

The user must take the necessary precautions concerning the optical output of the unit and follow the manufacturer's instructions.

Introducing the SmartOTDR

This chapter provides a general description of the SmartOTDR.

Topics discussed in this chapter include the following:

- [“Unpacking the SmartOTDR” on page 6](#)
- [“Hard keys and Indicators” on page 8](#)
- [“Power Supply” on page 9](#)

Unpacking the SmartOTDR

- 1 Open the cardboard box and pull the SmartOTDR and its accessories out of the box..
- 2 Check if all standard accessories are included in the box. Optional accessories might be delivered in a separate box.

If any part is missing or damaged please contact your local VIAVI customer service.

Each SmartOTDR comes with:

Table 5 Standard SmartOTDR accessories

A Li-Polymer battery, set into the equipment and which must be charged before use
A mains adapter used for mains operation of the unit and battery charging
4 country adaptable plugs (Europe / UK / US / Australia)
A hands-free soft case
A stylus pen for capacitive touchscreen

Figure 1 SmartOTDR



Figure 2 SmartOTDR: Front view

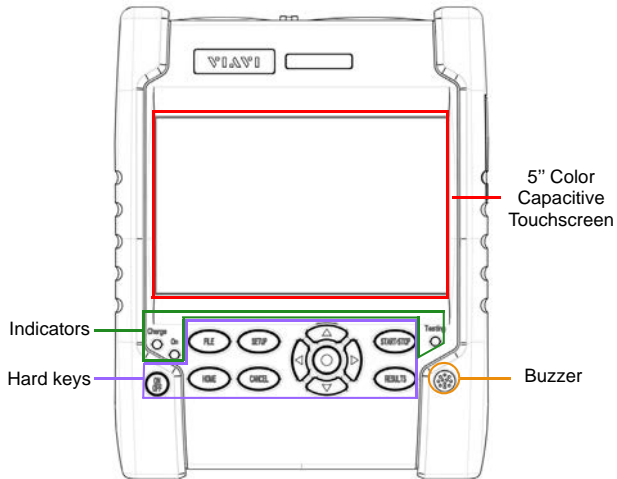
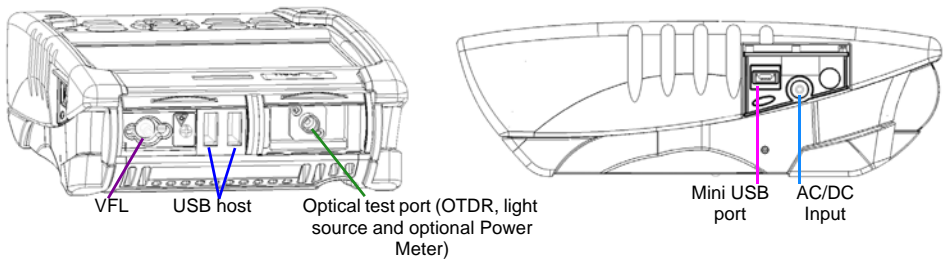

Figure 3 SmartOTDR: Side and top views



Hard keys and Indicators

Front panel hard keys

Figure 4 Hard keys and Indicators

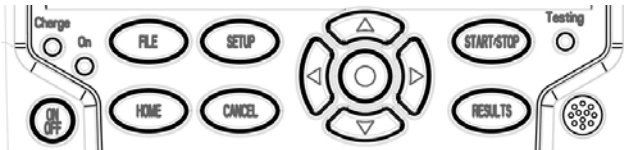















Table 6 Hard keys description

Hard key	Function
	Power (ON/OFF) button
	To access the File Explorer and manage test results.
	To access the Home page.
	To access the active test application settings.
	To deselect a test application.
	To Start or stop a measurement.
	To access the active test application results.
	To navigate on the link map or scroll through the list of test results.

Front panel LED indicators

The SmartOTDR is equipped with three LED indicators, lit into a different color according to the status of the unit.

Table 7 Indicators Status

On indicator		
	<i>Blinking</i>	The unit is off and connected to an external power source.
	<i>Solid green</i>	The unit is on, connected to an external power supply or operating on battery power.
Charge indicator		
	<i>Solid green</i>	The unit is connected to an external power source and the battery is fully charged.
	<i>Solid red</i>	The unit is connected to an external power source, and the battery is on charge.
Testing indicator		
	<i>Solid red</i>	An OTDR measurement is in progress

When the **Charge** indicator is blinking red, this mean the power supply is not compatible with the battery used. Charge is disabled.

Power Supply

The SmartOTDR operates with the following power source

Figure 5 SmartOTDR power supply

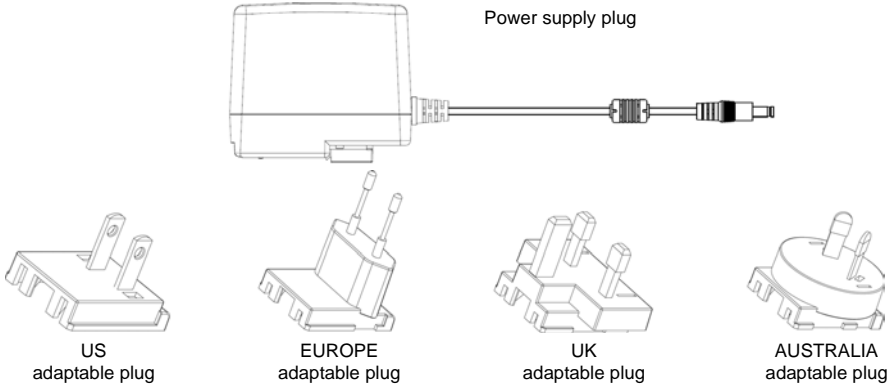

Starting up

This chapter describes the first steps to perform when using the SmartOTDR.

The topics discussed in this chapter are as follows:

- [“Setting the adaptable plug to the mains adapter” on page 12](#)
- [“Charging the battery” on page 13](#)
- [“Turning the SmartOTDR on and off” on page 15](#)
- [“Built-in kickstand” on page 16](#)
- [“First startup: configuring the regional settings” on page 17](#)

Setting the adaptable plug to the mains adapter

The SmartOTDR is supplied as standard with a mains adapter and 4 country adaptable plugs (Europe / UK / US / Australia).

Setting the correct plug to the mains adapter

- 1 Slide AC plug into adapter body as shown below.
- 2 Ensure tabs are located in slots shown before installing AC plug.
- 3 Insert AC plug fully until it «snaps» (clicking noise) into place.

Figure 6 Setting the adaptable plug onto the mains adapter

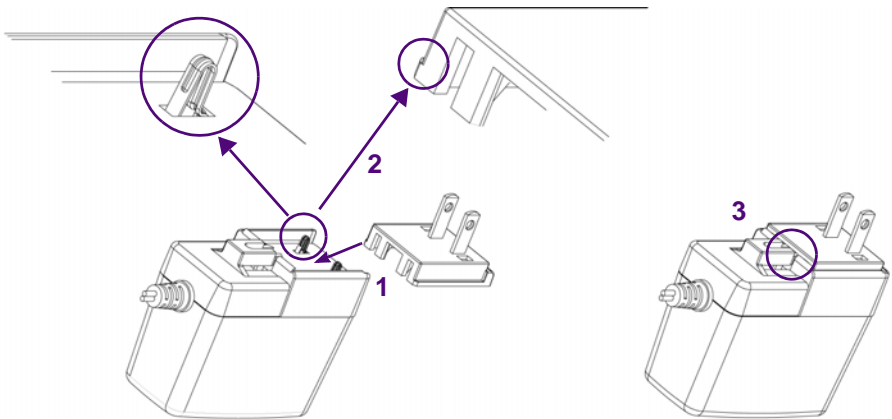

If the adapter plug is not correctly set onto the mains adapter, the connector may be damaged.

Removing the AC plug from the mains adapter

- 1 Press both sides of dovetail.
- 2 While holding the dovetail, press down on AC plug slightly and slide AC plug out.

Figure 7 Removing the adaptable plug from the mains adapter

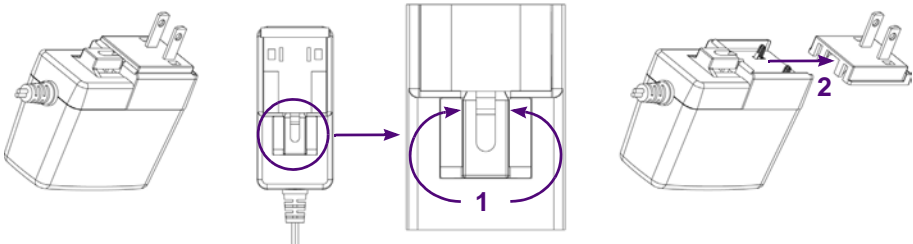

Charging the battery



CAUTION

Upon reception of the product, the battery of the SmartOTDR needs to be fully recharged, no later than 6 months after the date of calibration. If the product is unused for a long period, the battery needs also to be periodically fully recharged, with a period not longer than 12 months

Connecting the mains adapter

- 1 Set the appropriate adaptable plug to the power supply cable, according to your country (see [page 12](#)).
- 2 At the right side of the SmartOTDR, lift up the power supply socket protector and plug in the mains adapter.
- 3 Connect the adapter to the mains.
The **On** indicator LED starts blinking green.



Use only the mains adapter supplied with the SmartOTDR. The adapter for some other electronic device may appear to be identical, but entails a risk of damage to the SmartOTDR.

First use of the battery

When the unit is being used for the very first time or when the battery has been replaced, the unit is not able to detect the charge level of the new battery.

In that case, the icon  is displayed on the upper banner of the screen.

For the battery status icon to reflect the actual power level of the new battery:

- 1 Connect the unit to a power source. Do not disconnect it until the battery is fully charged.
- 2 Once fully charged, disconnect the unit from mains, turn it on and allow the battery to completely discharge.
- 3 The battery can then be charged, and the unit used simultaneously.

Charging the Li-Po battery

On connection to the mains:

- if the user does not press **ON**, the battery will start the charge. In this case, the **Charge** indicator will be lit in red.
- when the user presses the **ON** key, the instrument starts up and the battery will charge during use (**Charge** indicator in solid red).

Once the battery is fully charged, the **Charge** indicator is lit in solid green.



The unit will need about 5 hours to be fully charged.

Battery charge level display





When the battery is installed in the instrument, a battery icon is displayed in the upper right corner of the screen. Example: .

Table 8 Battery icons



The battery capacity is superior to 75%

Table 8 Battery icons

	The battery capacity is set between 50% and 75%
	The battery capacity is set between 25% and 50%
	The battery capacity is inferior to 25%
	The battery capacity is unknown. Perform a full charge/discharge cycle to get back to a valid indication. This icon may appear when the unit is new and being turned on for the first time, when the battery has been replaced or when the battery has been unused for an extended period of time (several months).

- When the level becomes too low, the instrument emits a beep to inform the user until it switches off automatically after saving the current settings and test data.

Turning the SmartOTDR on and off

Turning on the unit

- 1 Press the **ON/OFF** key.
If the equipment is powered to mains, the battery will charge.
The **On** indicator pass from blinking to solid green.
The VIAVI logo appears on the screen while an auto test is carried out.
The unit is ready to be used when the Home page or running test application is displayed.



In the event of an unexpected mains power cut, if there is no battery, the current results and configuration will not be saved. Next time the instrument is turned on, it will return to its initial configuration.

Turning off the unit

To turn the unit off, press the ON/OFF button.



NOTE

Unless specified otherwise in this documentation, the settings configured on the unit are kept in memory even when the unit is turned off.



NOTE

If the unit stops responding, you can force a hardware reset by pressing and holding down the ON/OFF button for about 4 seconds.

Built-in kickstand

When used outside of its hand-free soft case, the unit can be set on a flat surface (table, ground...) that is stable and not exposed to vibration.

The unit can be used with the built-in kickstand closed ("seated user" position) or pulled out ("standing user" position).

To change the stand from "seated user" position to "standing user" position, pull the stand outside of its housing until the stop.

Push the stand to return to «seated user» position.

Figure 8 SmartOTDR «seated» and «standing» user positions



First startup: configuring the regional settings

The first time the SmartOTDR is turned on, the screen displayed allows to configure regional settings (language, date, time, date & time format).

Those settings can be changed later if necessary in the **System Settings** Menu.

Figure 9 Regional Settings



- 1 Touch **Language** and select a language from the list.
- 2 Touch **Date** and enter the current date, using the numeric keypad displayed using the menu key **Edit Number**.
- 3 Touch **Time** and enter the current time, using the numeric keypad displayed using the menu key **Edit Number**.
Date and time are displayed on the upper right side of the screen.
- 4 Touch **UTC Offset(hours)**, tap **Edit Number**, enter your time zone offset and tap **Enter**.
- 5 Touch **Date Format** and configure the following parameters:
 - **Date format**: select one of the options **dd/mm/yy** or **mm/dd/yy**.
 - **Time format**: select one of the options **24 hour clock** or **12 hour clock**.
- 6 Once all parameters are correctly entered, press **Exit** menu key to return to **System Settings** page.



NOTE

For "Day Light Saving", only change the UTC offset as needed. This will automatically update the time field.

Setting-up the SmartOTDR

This chapter describes the operations for configuring the instrument.

The topics discussed in this chapter are as follows:

- [“Displaying the System Settings screen” on page 20](#)
- [“Configuring screen and display settings” on page 21](#)
- [“Defining the Automatic shutdown and the storage limit” on page 22](#)

Displaying the System Settings screen

To display the **System Settings** screen, you must:

- 1 Press the **HOME** hard key to reach the **Home** page.

Figure 10 Home page



- 2 Activate the **Settings** icon  to open the **System Settings** screen.

Figure 11 System Settings page

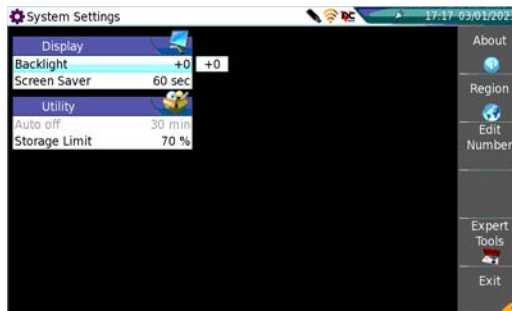

NOTE

If you are in the Regional Settings page, and you press **Exit**, then the **System Settings** page automatically displays.

Configuring screen and display settings

In the **System Settings** page, the following parameters can be defined:

Backlight

- 1 Touch **Backlight**
- 2 Define the backlight level of the screen, using the left and right direction keys, or press **Edit Number** softkey and use the displayed keypad.
 - Min backlight level: -5
 - Max backlight level: +5



NOTE

The higher the backlight level, the higher the power consumption. Reducing the display brightness (backlight level) will save battery power.

Screen Saver

The screen saver feature allows saving battery power without turning off the unit.

To configure the screen saver:

- 1 Touch **Delay** and select the time of inactivity before the screen saver starts: **60s**, **3 min**, **5 min**.
The parameter **No** deactivates the screen saver function.

When the screen saver is enabled and the unit is inactive for the specified amount of time, the screen becomes black and a SmartOTDR picture is displayed.

Defining the Automatic shutdown and the storage limit

Automatic shutdown

The automatic shutdown function turns off the SmartOTDR automatically when the unit has been inactive for a specified amount of time. Work in progress is automatically saved.



The automatic shutdown function is available when the unit is on battery operation only.

- 1 In the **Utility** box, touch **Auto off** parameter.
- 2 Choose the duration of inactivity before the unit automatically turns off: **5**, **10** or **30 minutes**.

Storage Limit

Enter a percentage value between **70%** and **95%** in the **Storage Limit** box.

A pop-up message will be displayed when the defined storage limit is reached.

Optical options

The unit can be equipped with an optional built-in Visual Fault Locator (VFL).

The topics discussed in this chapter are as follows:

- [“Optical Power Meter and Light Source Functions” on page 24](#)
- [“Built-in Visual Fault Locator \(VFL\) Function” on page 24](#)

Optical Power Meter and Light Source Functions

For power meter and light source functions, please refer to the OTDR User Manual.

Figure 12 Optical connectors

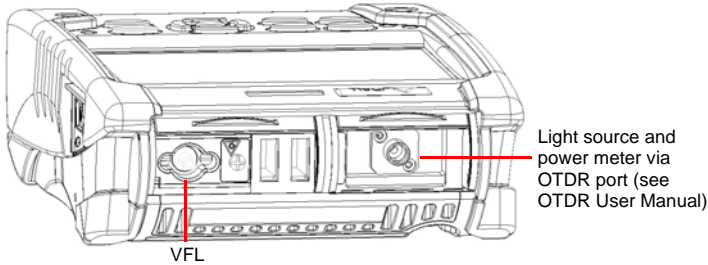

Built-in Visual Fault Locator (VFL) Function

VFL connector

The VFL interface is fitted with universal 2.5mm sleeve accepting all 2.5 mm connector ferrules (FC, SC, ST, DIN, E2000, etc.)

Using the built-in VFL

A visual fault locator (VFL) is an essential tool that quickly and easily locates problems such as sharp bends, breaks, and damages in fiber with a visible red laser light.

It can also be used to conduct end-to-end continuity tests and to perform fiber tracing and identification. The maximum working distance of a VFL is 5 km.



NOTE

In some cases, the pulsed mode (blinking light) makes it easier to identify faults than continuous light.

To operate the VFL:

- 1 Connect the fiber to the VFL port located at the top of the unit.
- 2 Press the **HOME** key and activate the VFL .
- 3 Select CW for Continuous Wave Mode or 1 Hz for Pulsed Mode.

Figure 13 VFL activation



When VFL is active, the icons   display on the upper banner of the screen.

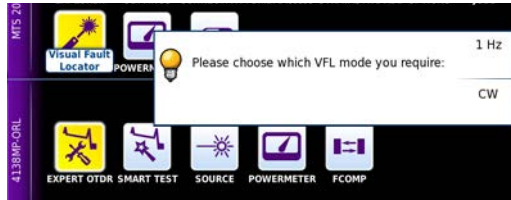

NOTE

Press again the **VFL** icon or the **CANCEL** hardkey on the unit to turn off the function.

Microscope application

The microscope application is a hot-plug feature enabled when connecting a VIAVI fiber inspection microscope to a VIAVI instrument that supports optical fiber testing.

The topics discussed in this chapter are as follows:

- [“Microscope Overview” on page 28](#)
- [“Connecting the microscope” on page 29](#)
- [“Using the microscope” on page 40](#)

Microscope Overview

A probe microscope enables verification that optical fiber connectors are sufficiently defect-free and suitable for service.

The P5000i Digital Probe Microscope and the FiberChek Probe Microscope are portable handheld microscopes used to view and inspect both the bulkhead (female) and patch cord (male) sides of fiber optic connectors as well as other optical devices like transceivers.

The P5000i probe and the FiberChek probe require an FBPT inspection tip. An FBPP barrel assembly may also be required depending upon the tip.

The P5000i probe is connected to the instrument with a USB-A connector.

The FiberChek is connected to the instrument with a micro-USB connector or via WIFI.

Figure 14 P5000i Probe components



Before using the P5000i scope, ensure that the Bluetooth option on the host instrument has never been activated after starting the instrument. If it has been activated, stop and restart the instrument before using the P5000i probe.

Fig. 15 FiberChek Probe Overview

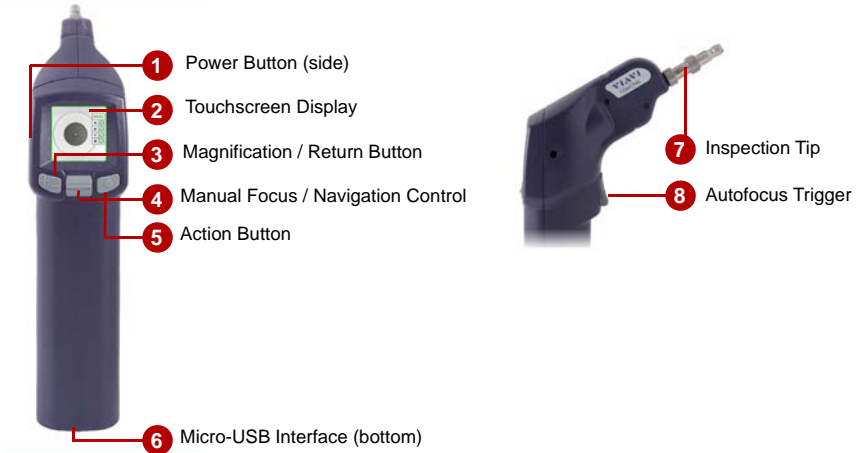

Connecting the microscope

P5000i probe USB connection

1 Plug the P5000i probe into a USB port from the SmartOTDR.

2 Touch the Home button

3 Launch the Microscope application



More than one application may be active on the unit (e.g. both inspection and OTDR)

4 Connect the probe with the fiber being inspected using the appropriate tip.

FiberChek probe WIFI connection

1 Turn on the microscope.

2 Enable the WIFI connection on the microscope.

3 On the unit, press the **HOME** button.

4 Touch **Connectivity > Wireless**.

- 5 Verify that **WLAN Mode = Wireless Client**
- 6 Touch **SCAN SSID** to locate the microscope.

Fig. 16 Microscope FiberChek detected via WIFI



- 7 Touch the FiberChek SSID.
- 8 Touch **Select**.
The FiberChek SSID will appear under Configuration.
- 9 Touch **Connect SSID**.
The WIFI icon will change if the connection is successful.
- 10 Return to the **Home** page.
- 11 Launch the **Microscope** application .
More than one application may be active on the instrument (e.g., both inspection and OTDR).
- 12 Connect the probe to the fiber being inspected using the appropriate tip.

FiberChek probe USB Connection

- 1 Connect the micro-USB end of a micro-USB-to-USB-A cable to the micro-USB port on the FiberChek probe.
- 2 Plug the USB-A end of the cable into a USB port on the instrument.

Figure 17 USB connection of the FiberChek probe



- 3 Touch the **Home** button.
- 4 Launch the **Microscope** application . More than one application may be active on the instrument (e.g., both inspection and OTDR).
- 5 Connect the probe to the fiber being inspected using the appropriate tip.

Configuring the microscope

Test Setup

- 1 Launch the microscope application and connect a fiber to the probe inspection tip.

Figure 18 Scope Live view

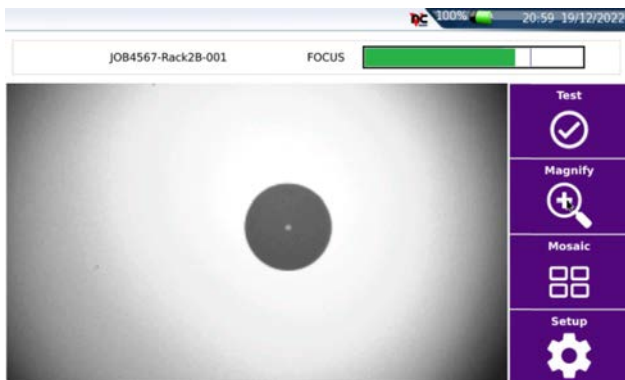

- 2 Touch the **Setup** softkey
- 3 Touch the **Test Setup** link

Figure 19 P5000i Scope Setup

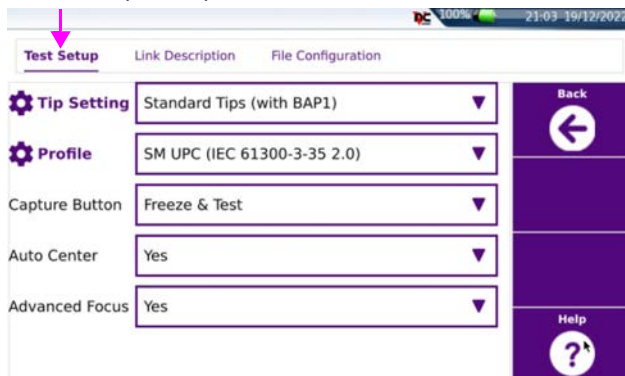

- 4 Touch the **Profile** dropdown box and select the Profile to be used for automated end face image analysis.

Figure 20 Profiles' List

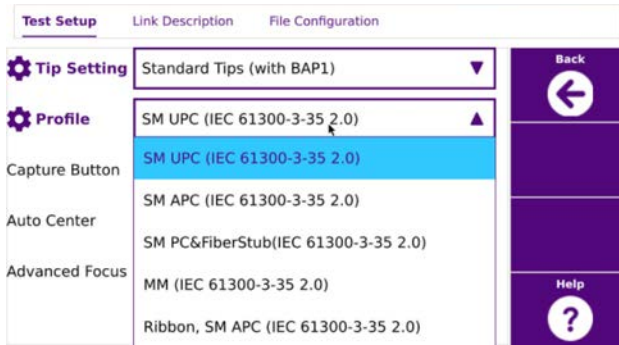

The profile contains the failure criteria used during automated assessment of the end face image.

- 5 Touch the **Tip Setting** dropdown box and select the Tip Setting to be used to illuminate the fiber end face.

Only tip settings that are valid for the selected profile will be displayed.

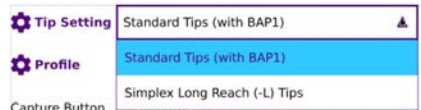

- It is important to select the appropriate tip setting for the inspection tip connected to the probe
 - The tip setting changes how the fiber end face is illuminated. The objective is to provide enough illumination to expose defects, while not providing too much illumination such that there is a lack contrast between the end face and a defect.
- 6 Touch the **Capture Button** dropdown box to change the operation of the **Test** softkey and probe capture button/trigger.

Freeze & Test: the live end face image is captured, and an automated profiled-based analysis is performed

Freeze image: the live end face image is captured
 - 7 Touch the **Auto Center** dropdown box to change automated image centering

Yes: the end face image is automatically centered within the image view window

No: automated image centering is disabled
 - 8 Touch the **Advanced Focus** dropdown box to change Focus meter appearance

Yes: meter is Green when the image is sufficiently in focus for automated analysis.



Red when the image focus is too low.



No: indication of focus level via colors is disabled

Link Description

- 1 Launch the microscope application and connect a fiber to the probe inspection tip.
- 2 Touch the **Setup** softkey.
- 3 Touch the **Link Description** link.

Figure 21 Link configuration

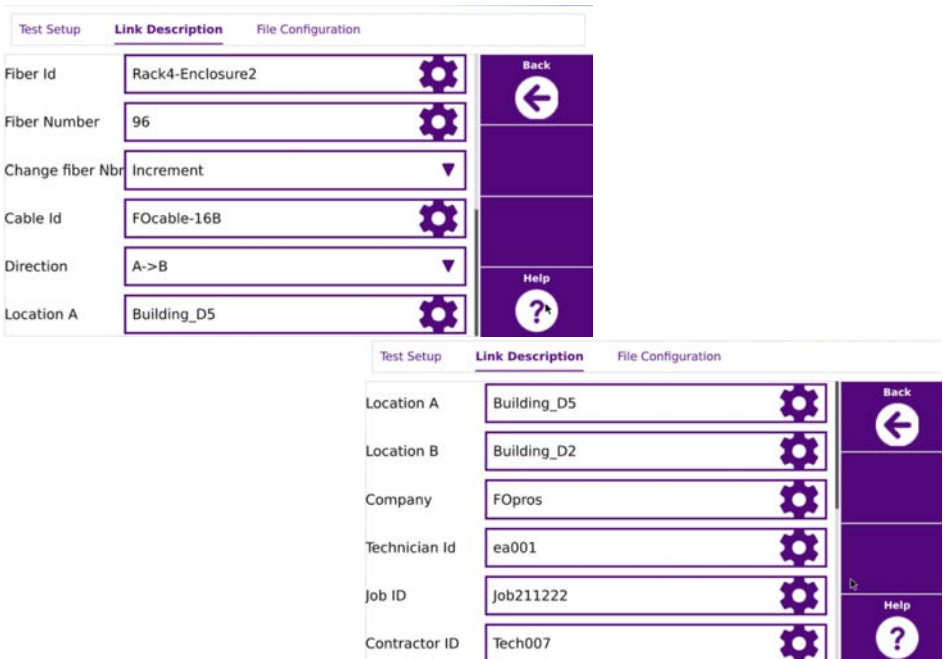

- 4 Touch the **Fiber Id** setup icon to change the name used to identify the fiber under test.
An alphanumeric keypad is displayed to facilitate creation of a new name
- 5 Touch the **Fiber Number** setup icon to change the number used to identify the fiber under test.
A numeric keypad is displayed to facilitate changing the fiber number.
- 6 Touch the **Change Fiber Nbr** to enable automatic fiber number updating:
No: the fiber number is not updated automatically.
Increment: the fiber number is automatically incremented by 1 after saving a test result.
Decrement: the fiber number is automatically decremented by 1 after saving a test result.
User Defined: the fiber number is automatically updated as defined by the user. A setup field appears when **User Defined** is selected.
Touching the setup icon opens a keypad where the update value is entered.
A minus sign ("-") before the value indicates automated decrementing, whereas no sign indicates automated incrementing by the value entered.
- 7 Touch the **Cable Id** set up icon to change the name used to identify the cable under test.
A combination of **Cable Id**, **Fiber Id**, and **Fiber Number** is typically sufficient to uniquely identify the fiber under test.
- 8 Touch the **Direction** dropdown box to identify the direction from which the test is performed:
A -> B: from the origin to the extremity.
B -> A: from the extremity to the origin.
- 9 Touch the **Location A** setup icon to change the name of location A (origin).
- 10 Touch the **Location B** setup icon to change the name of location B (extremity).
- 11 Touch the **Company** setup icon to change the name of the company performing the test.
- 12 Touch the **Technician ID** icon to change the name of the individual performing the test.
- 13 Touch the **Job ID** icon to change the name of the job used to identify a group of tests.
- 14 Touch the **Contractor ID** to change the name of the contractor performing the test.
These descriptors are listed in the header of a PDF report when a test result is saved.

Figure 22 Header of the PDF report

FOpros	
Cable ID	FOcable-16B
Fiber ID	Rack4-Enclosure2 96
Direction	A->B
Location A	Building_D5
Location B	Building_D2
Technician Id	ea001
Job ID	Job211222
Probe	FBP-P5000I S/N 1486070078
Test date	21/12/2022 17:13 (UTC+0)
Profile	SM UPC (IEC 61300-3-35 2.0)
Comment	SC/UPC Connector

Pass

File configuration

- 1 Launch the microscope application and connect a fiber to the probe inspection tip.
- 2 Touch the **Setup** softkey
- 3 Touch the **File Configuration** link

Figure 23 File configuration



- 4 Touch the **Dir. Naming** setup icon to change the directory where test results will be saved on the instrument.
An alphanumeric keypad is displayed to facilitate the creation of a new directory name.

Touch the "[auto]" key to expose a list of useful recommendations like **Function / Job_Id** or **Current_Dir**.
The directory name after making changes is indicated in the gray box immediately below **Dir. Naming**.

Fig. 24 Directory - Edition keypad

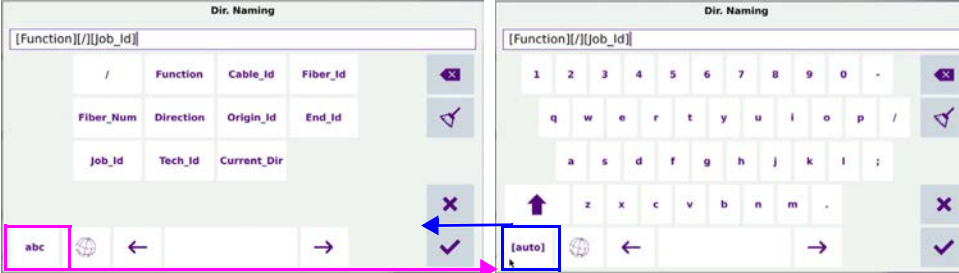

- 5 Touch the **Filenaming** setup icon to change the default file name scheme for individual test results

An alphanumeric keypad is displayed to facilitate the creation of a file naming scheme.

Touch the "[auto]" key to expose a list of useful recommendations like **Cable_Id**, **Fiber_Id**, **Fiber_Num**, and **Date_Time** to derive a unique naming scheme. Separating naming elements with a "-" character makes it easier to read the file name.

The file naming scheme after making changes is indicated in the gray box immediately below **File naming**.

Figure 25 Filenaming - Edition keypad (auto)

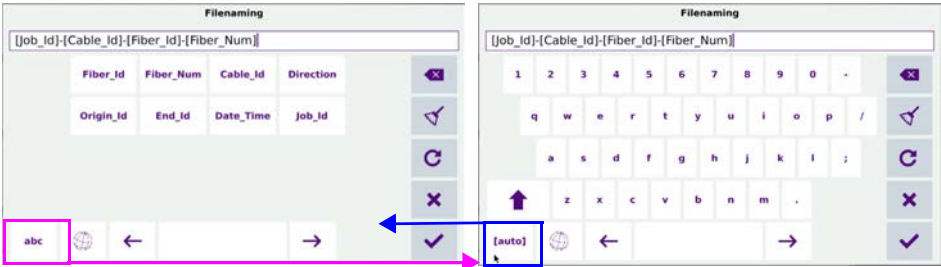

- 6 Touch the **Logo** setup icon to add a custom logo to test reports
 - a Copy a logo file in JPG format to a USB flash drive.
 - b Plug the USB drive into the instrument.
 - c Navigate to the USB drive.
 - d Select the logo file.
 - e Touch **Load**.
- 7 Touch the Auto Save dropdown box to automatically save a test result:
Yes Always: test result always saved.
Yes on Pass: test result saved only if the test result is a Pass.
No: automatic saving is disabled.
- 8 Touch **Report As** file formats to define how test results are saved:
Format options: **JPG** (default), **PDF**, **JSON**.
More than one format may be selected.

Tip and Profile Management

- 1 Touch the setup icon next to **Tip Setting** to manage tip settings.
- 2 Touch the check boxes next to the tip setting name to define what settings will appear in the **Tip Setting** dropdown box.

Figure 26 Manage tips



- 3 Touch **Apply**.

- 4 Touch the **Add** softkey to add a new tip setting:
 - a Copy the new tip setting onto a USB flash drive.
 - b Plug the USB drive into the instrument.
 - c Navigate to the USB drive.
 - d Select the tip setting file.
 - e Touch **Load**.
- 5 Touch the setup icon next to **Profile** to manage profiles.
- 6 Touch the check boxes next to the profile name to define what profiles will appear in the **Profiles** dropdown box

Figure 27 Manage Profiles



- 7 Touch the **Add** softkey to add a new profile:
 - a Copy the new profile onto a USB flash drive.
 - b Plug the USB drive into the instrument.
 - c Navigate to the USB drive.
 - d Select the profile file.
 - e Touch **Load**.

Using the microscope

Running an automated test

- 1 Launch the microscope application.
- 2 Connect a fiber to the probe inspection tip.
- 3 Focus the end face image:
Use the focus control wheel if a P5000i microscope or the autofocus trigger if a FiberChek microscope.
The focus meter will indicate the focus level.
The focus meter will be green if **Advanced Focus = Yes** and the focus level is sufficient for automated analysis.

Figure 28 Example of the result using the P5000i scope

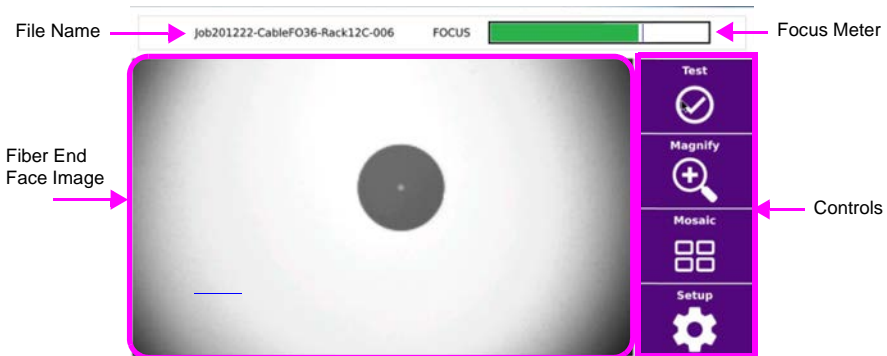







- 4 Touch the **Test** softkey  or press the test button on the microscope. The **Test** softkey will be accessible if the **Capture Button** setting = **Freeze & Test**.
The **Freeze** softkey  will be accessible if the **Capture Button** setting = **Freeze image**.
- 5 View the end face image and note the test result:
 - **Pass**: green  next to result, image outlined in green, green  per zone.
 - **Fail**: red  next to result, image outlined in red, red  next to failing zones.

Figure 29 Scope Test results



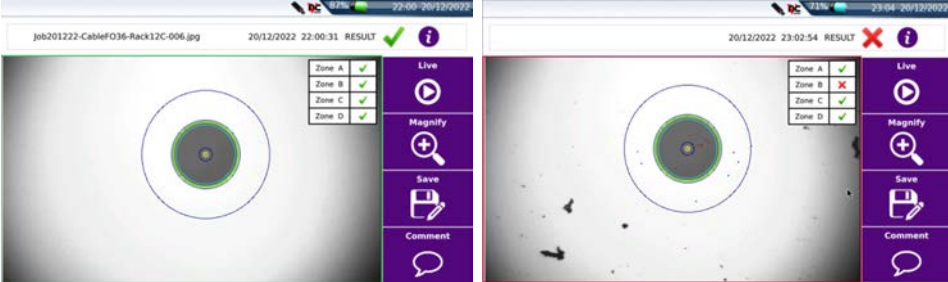

- 6 Touch the zone information box to hide the box and the overlays.
Touch the overlays icon  to unhide the zone information box and the overlays.
- 7 Touch the information icon  to view additional test result details.

Figure 30 Additional test results details





- 8 Touch the Magnify softkey to toggle between low and high magnification image views

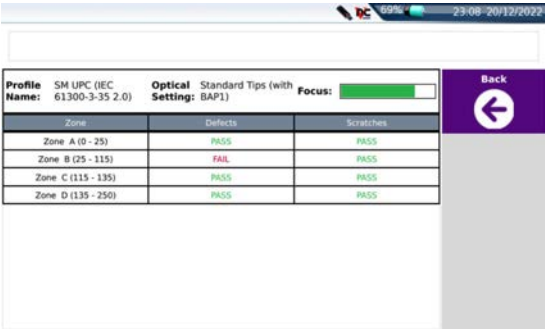

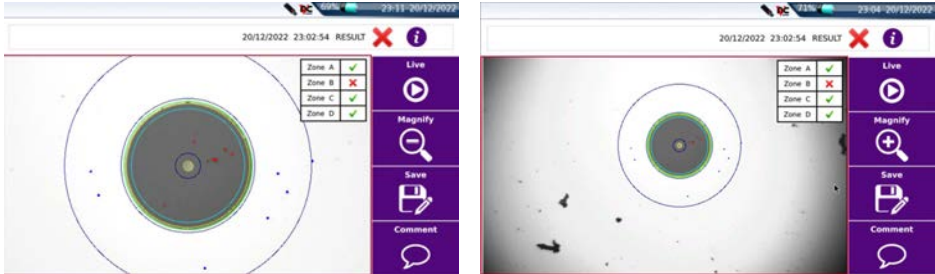
Figure 31 Magnified images



- 9 Touch the **Comment** softkey  to add a note to a saved test result:
 - An alphanumeric keypad is displayed to facilitate adding a comment.
 - The comment will appear on the bottom left corner of the image and on reports.
- 10 Touch the **Live** softkey  to exit the tested or captured image view.
- 11 Touch the **Save** softkey  to save the test result:
 - Touching the softkey is unnecessary if **Auto Save = "Yes Always"** or **Auto Save = "Yes on Pass"** and the result is a pass. Enabling **Change Fiber Nbr** (not equal to **"No"**) is recommended if **Auto Save** is set to **Yes**. The file name with an extension will appear in the top information bar when the save operation is complete.
 - Touching the **Save** key opens an alphanumeric keypad to facilitate creating the file name.
- 12 Touch the **Live** softkey to return to fiber inspection.

Viewing prior images (Mosaic Mode)

- 1 Touch the **Mosaic** softkey  .
 - Up to four end face images are displayed.
 - Top left is the current Live view.
 - The three most recent images are displayed in order of acquisition: top right, bottom left, bottom right.

Figure 32 Mosaic mode



- 2 Touch the **Magnify** softkey to toggle between low and high magnification image views.
- 3 Touch an image to select it.
A yellow outline will appear around the selected image.
- 4 Touch the **Full** softkey  to return to a single-image, full screen view.
- 5 Touch **Test** or **Setup** softkeys if the Live (top left) image is selected.
- 6 Touch the **Save** or **Comment** softkeys if a non-live image is selected.

Accessing online help

- 1 Touch the **Help** softkey  located on several setup screens to find a link and QR code for online help.

Online help includes videos, posters, and product information.

Connectivity

This chapter describes the different ways to access to the SmartOTDR interface or content using different connection modes.

Topics described in this chapter are as follows:

- [“Establishing connection” on page 46](#)
- [“Remote Control” on page 59](#)
- [“Stratasync” on page 79](#)

Establishing connection

Checking Bluetooth/WIFI option is installed

Once the WIFI/Bluetooth option is installed (see “Installing the Bluetooth/WIFI option” on page 131):

- 1 Turn on the SmartOTDR, pressing **ON** button.
- 2 On the **Home** page, press **Connectivity** icon .
- 3 Check the following icons are displayed according to the option(s) installed:



You can also go in **Settings > About** and check that **Bluetooth** and **Wireless** options have a green tick / check mark.



NOTE

WIFI and Bluetooth options do not require any software license to be active.

Via Bluetooth

Pairing the Platform with a device

- 1 On the **Home** page, press **Connectivity** key
 - 2 Under **Connectivity** page, select **Bluetooth**
- The following screen displays

Figure 33 Bluetooth disabled

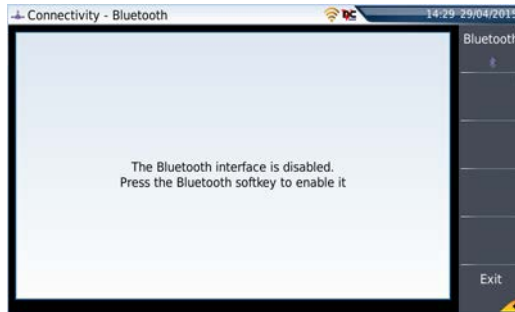

- 3 Press the menu key **Bluetooth** to enable the Bluetooth interface. The icon  is displayed on the upper banner of the screen. The Paired Bluetooth Devices screen appears.
- 4 Press the **Become Pairable** soft key to wait for another device to initiate the connection to the SmartOTDR. A screen as the following one displays:

Figure 34 Waiting for pairing





- 5 Activate Bluetooth on the equipment which need to be paired with the Platform
- 6 If you are asked to, validate a pairing code on the equipment.
- 7 In this case, validate the pairing code on both equipments.

Both equipment are now paired:

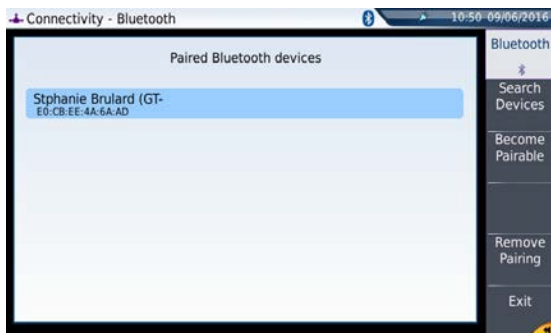
Figure 35 Platform paired with one equipment



The icon has a blue background when paired with a device , versus no background when not paired .

Searching new devices to be paired with the Platform

- 1 If the desired device is not displayed on the screen, or if no devices are detected, press the **Search Devices** soft key.
The SmartOTDR is searching for the devices which could be used via Bluetooth with the equipment.



REMINDER



You may need to activate bluetooth on the other device to allow pairing.

A barograph is displayed during research 

Once the research is completed, a list of the available devices is displayed, with the level of detection of the SmartOTDR

Figure 36 List of devices found



- a Select the device to be paired with the Platform
It will be underlined in blue.
 - b Push the **Pair** key to connect the device to the Platform
- 2 If prompted, enter a pairing code. The code must be identical on the SmartOTDR and the device.
 - 3 Once the bluetooth device and the Platform are paired, a screen is displayed with the description of the device (see [Figure 35 on page 48](#)).
The icon has a blue background when paired with a device , versus no background when not paired .

You can now go to the file explorer and transfer files from the SmartOTDR toward the bluetooth device and vice versa (see [“Transferring files via Bluetooth” on page 73](#)).

Removing the Pairing

To remove the pairing between the two equipments

- 1 From the Home page, press **Connectivity > Bluetooth**.
- 2 Push the **Remove pairing** key
The icon on the upper banner of the screen becomes  showing the Platform is no more connected to a bluetooth device, but the Bluetooth option is still active.

To deactivate the bluetooth onto the Platform, press **Bluetooth** menu key to disable the interface.

Via Wifi

Configuring the WiFi access

- 1 Restart the SmartOTDR, pressing **ON** button.
- 2 On the **Home** page, press **Connectivity**.
The **Connectivity** page opens.
- 3 In the new page, select the **WIFI** icon.
The WiFi **Setup** screen displays.
- 4 Press **Wireless** menu key to enable the Wifi interface.
The icon  is displayed on the upper banner.



Figure 37 WIFI Setup screen



Once the Setup screen is displayed, configure the WiFi connection:

- 5 Press **Scan SSID** menu key to scan for Service Set Identifiers (SSIDs) in the area.
- 6 Wait for the list of SSIDs to be displayed.

Figure 38 List of SSIDs found



- 7 Select the desired network to connect to.
- 8 Press **Select** menu key to validated the connection.
The display goes back to Setup screen.
The **SSID** parameter is automatically configured with the one selected.
- 9 In **Encryption** parameter, select the type of encryption wished: **None**, **WEP Static**, **WPA Personal**, **WPA Enterprise**.
- 10 According to encryption type selected, enter **Login** (if any needed) and **Key/Password**.





NOTE

Login and Password are kept in memory, even if the WiFi is deactivated or the SmartOTDR switch off and restarted.

- 11 In the **AutoConnect** parameter, select if the connection to SSID selected must be done automatically (**On**) or not (**Off**).

Connection to SSID

Once configuration is valid, connect the SmartOTDR to the Wireless network:

- 1 In the Setup screen, press **Connect SSID** menu key.
or
If **AutoConnect** is defined to **On**, the connection is launched automatically.
Once association of Platform with SSID is established, the icon  becomes  to indicate the connection is active.

Configuring the WiFi mode to which the Platform is connected

To work on WIFI with the Platform, configure the **802.11** parameter on the WIFI Setup screen.

1 Select the mode of connection:

- **Config 1 to 4** static mode enabling input of the configuration of 4 sites. If this parameter is selected, the following parameters must be entered:
 - Site Name the user can enter the name of the site in the Edit menu.
 - IP Address IP address of the SmartOTDR
 - IP Mask address of the mask of the sub-network
 - IP Gateway IP address of the machine enabling access outside the sub-network.
 - DNS (Domain Name Server) IP address of the machine providing the IP address on the basis of the name
- **Dynamic** in this mode, which requires a DHCP server, the SmartOTDR requests an IP address from this server which will be allocated dynamically if dynamic host configuration is activated on the local network.
After selecting this mode or after power-on, the SmartOTDR tries to establish a connection to obtain an address from a DHCP server. If for any reason, this process fails, the equipment reverses to static IP address mode with User1 IP address.

Note the IP address of the Platform, to be able to remote screen on PC or to transfer files.

Figure 39 WIFI connection in Dynamic mode

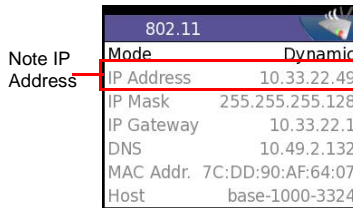

802.11	
Mode	Dynamic
IP Address	10.33.22.49
IP Mask	255.255.255.128
IP Gateway	10.33.22.1
DNS	10.49.2.132
MAC Addr.	7C:DD:90:AF:64:07
Host	base-1000-3324

2 Configure the **Proxy** dialog box:

In the **Use proxy** parameter

- Select **No** if no proxy is used.

- Select **Manual** to enter manually the **Proxy address**
- Select **Auto** and enter the **Pac address**.

Creating a network from the SmartOTDR

A WIFI network can be created from the SmartOTDR, in order to associate it to a Smart-phone or Tablet.

- 1 From the **Home** page, press **Connectivity > Wireless 802.11**.
- 2 On the **Setup** screen, select the Wlan Mode for WIFI connection: **Ad-hoc (IBSS)** or **AP Master**.
- 3 Press **Create Network** menu key and wait for the network creation.
The network creation on platform is completed once the dialog box is no more displayed.
- 4 On the Smart device, open the Wifi setup age.
- 5 Check the Platform has been detected (SSID identifier displayed in the list of WIFI networks found)
- 6 Touch this SSID and follow the instruction on your Smart Device to link it to the Platform.

Via Ethernet

The connection between SmartOTDR and PC can be done directly, or via a local network.

Connecting the SmartOTDR and the PC

- 1 Connect the SmartOTDR to the PC via an Ethernet cable, using the USB Ethernet - adapter and an ethernet cable.

Figure 40 Connection SmartOTDR and PC

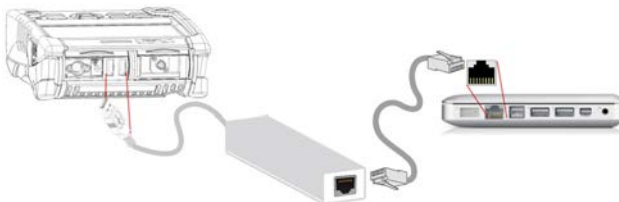

- 2 Make sure the network configuration onto the PC is set to the **Dynamic** mode:
 - a Click on **Start > Control Panel**.
 - b Double click on **Network Connection**.
 - c Double click on **Local Area Connection**.
 - d In the dialog box, click on **Properties**.
 - e Check the parameter **Internet Protocol (TCP/IP)** is selected () and click once on it (underlined in blue)
 - f Click on **Properties** button.
 - g On the tab **General**, check the parameter **Obtain an IP address automatically** is selected () ; if not, click to select it.

Figure 41 Internet Protocol

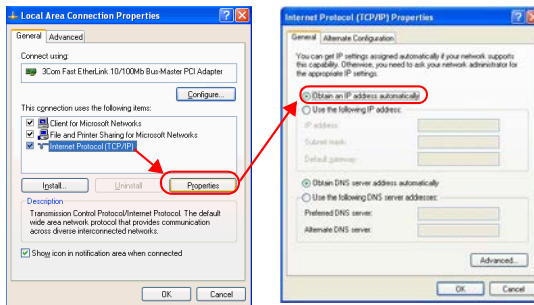

- h Click on **Ok** and close all the dialog boxes opened onto the PC.

Configuring the SmartOTDR via Ethernet

- 1 In the **Home** page, validate the **Connectivity** icon.
- 2 In the connectivity page, validate the **Ethernet** icon 
- 3 In the **I/O Interfaces** box, configure the following parameters:

Remote Screen

Remote screen = Session or Permanent must be confirmed in both cases, in the Interface E/S window.

- **No** the screen cannot be remote on to a PC or on to another SmartOTDR.
- **Session Mode** the Remote screen function is inactive once the SmartOTDR is switched off.
- **Permanent Mode** the Remote screen function is still active when the SmartOTDR is switched off and restarted.
- **Permanent with password** Same function as the Permanent mode, with an access to the equipment via VNC protected by a password:
42000

The password to access VNC can be modified:

- 1 Touch the **Change password** menu key.
- 2 Enter the current password in the Edition keypad and touch **Enter** to validate.
- 3 Enter the new password and touch **Enter** to validate.

Ethernet > Mode

Parameters of the local Ethernet network to which the SmartOTDR is connected:

- **Config 1 to 4** static mode enabling input of the configuration of 4 sites. If this parameter is selected, the following parameters must be entered:
 - Site Name the user can enter the name of the site in the Edit menu.
 - IP Address IP address of the SmartOTDR
 - IP Mask address of the mask of the sub-network
 - IP Gateway IP address of the machine enabling access outside the sub-network.
 - DNS¹ IP address of the machine providing the IP address on the basis of the name
 - Domain name name of the local network to which the SmartOTDR is connected.
- **Dynamic** in this mode, which requires a DHCP server, the SmartOTDR requests an IP address from this server which will be allocated dynamically if dynamic host configuration is activated on the local network.
After selecting this mode or after power-on, the SmartOTDR tries to establish a connection to obtain an address from a DHCP server. If for any reason, this process fails, the

1.Domain Name Server

SmartOTDR reverses to static IP address mode with User1 IP address.



NOTE

Once the SmartOTDR is connected to the network, the icon  indicates the connection is working.

Proxy > Use proxy

- 1 Select **No** if no proxy is used.
- 2 If **Manual** has been selected, enter the **Proxy Address**.
- 3 If **Auto** has been selected, enter the **Pac Address**.

Figure 42 Example of configuration for I/O Interfaces box

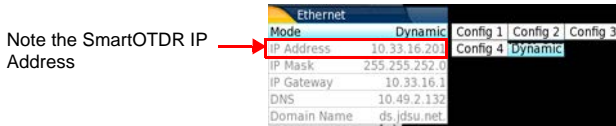

- 4 Note the IP Address.
- 5 Wait about 10 seconds the connection is established.

The SmartOTDR Interface can now be transferred onto the PC, or the internal memory or USB key contents can be transferred on PC.

Via Cloud Storage

Principle and prerequisites of the Cloud Storage

The Cloud storage defined the outsourcing of data on distant servers, which avoid the data storage on a local workstation.

The cloud storage onto a SmartOTDR allows to transfer the files from the Platform toward a distant server and vice-versa.

Before configuring the Cloud Storage on Platform, you must first create an account on a Cloud Platform on internet.

The Cloud storage function onto the SmartOTDR works exclusively with sites using the **WebDav technology** such as CloudSafe (<https://secure.cloudsafe.com/pages/index.html>) or Box (<https://www.box.com/pricing/>).

Once account is created, with WevDav configuration, you get the following information for connection:

- URL
- Login Name
- Login Password

Configuring and connecting to Cloud Storage on the SmartOTDR

Configuring the SmartOTDR

Once an account has been created on the Cloud site, configure the SmartOTDR before establishing the connection:



Before configuring the Cloud Storage, make sure the configuration for Ethernet parameters and Proxy parameters are correctly configured.

See “Ethernet > Mode” on page 55 and “Proxy > Use proxy” on page 56.

- 1 On the **Home** page, press **Connectivity**.
- 2 In the **Connectivity** windows, press **Cloud/File Storage**  .
A new page opens
- 3 In the **Url** parameter, enter the URL define for the Cloud server created on internet
- 4 In the **User** parameter, enter your Login created on your account
- 5 In the **Key / Password**, enter the password attributed by the Cloud server.

Figure 43 Example of configuration



Configuration on Cloud server (example with CloudSafe)

Connecting Cloud Storage

Once configuration has been established on the SmartOTDR, it is ready to be connected with Cloud server:

- 1 Select one parameter of the Cloud Storage window on SmartOTDR
- 2 Press **Connect Cloud Storage** menu key

The connection launches.

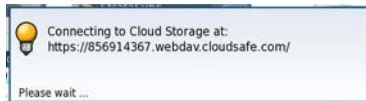

- 3 Once connection is established, a message displays in the window

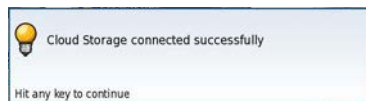

- 4 Press any key to continue, and start files transfer.

The icon  is displayed on the upper banner as long as the connection is active.

Disconnecting from Cloud storage

To disconnect the SmartOTDR from Cloud storage:

- 1 Press **HOME** hard key.
- 2 Select a parameter of the **Cloud Storage** window.
- 3 Press **Disconnect Cloud Storage** menu key.

Remote Control

Smart Access Anywhere

The SmartOTDR can be accessible to any network test locations, using a specific function: **Smart Access Anywhere**.

This function allows one distant user, on a PC, to transfer the Platform Interface and work on SmartOTDR or to access the internal memory / USB memory stick contents on the PC and perform files transfer from SmartOTDR to PC and vice-versa.

This feature does not need any license code if the user wants assistance from a VIAVI person located within the VIAVI network.

This feature requires a license code into the unit if the user wants any other assistance/support ("company A" willing to be remotely controlled by "company A or B").

The license **SAA-L2** is used for SmartAccessAnywhere using Ethernet, wifi hotspot connection, or USB / Wifi connection through smartphone.

The SmartOTDR can be used in combination with a PC in order to transfer the Platform Interface onto a PC, or to access the internal memory or USB memory stick contents on the PC.

Connection modes

Different kinds of connection are available to access to a distant SmartOTDR.

According to the connection type used, specific requirements are mandatory.

WIFI connection

- 1 The WIFI connection can be used to access to SmartOTDR from any location. This connection is available exclusively if the **WIFI option is installed onto the SmartOTDR** which will be seen remotely.

Figure 44 WIFI connection



USB/WIFI connection via Smartphone (Tethering)

To access to a SmartOTDR remotely, the connection between the unit and the VIAVI application can be established via a USB cable or WIFI, and through a Smartphone, having Internet Sharing capability via USB or WIFI.

- 1 To establish connection between SmartOTDR and Smartphone using USB, connect the USB cable on SmartOTDR and on Smartphone connector.

Figure 45 USB connection through Smartphone



- 2 To establish connection between the SmartOTDR and Smartphone using WIFI, the **WIFI option must be installed onto the SmartOTDR.**

Figure 46 WIFI connection through Smartphone



Pre-requisite for using the Smart Access Anywhere Application

To access to a SmartOTDR from any locations, specific requirements are mandatory:

- a license installed on SmartOTDR which will be accessible from any locations.
- an Ethernet connection (the Platform must have an IP address - see “Ethernet > Mode” on page 55) and, if the network uses a proxy, this proxy must be configured (see “Proxy > Use proxy” on page 56).
- the VIAVI application, downloaded for free at the address «<http://smartaccess.updatemyunit.net>».
- port 22 (SSH) or 443 (HTTPS) output opened
- according to connection mode selected:
 - the WIFI option installed on SmartOTDR.
 - a USB cable to connect SmartOTDR with Smartphone.
 - a Smartphone from given list and having appropriate basic subscription for internet connection sharing.

Downloading the VIAVI application on PC

The VIAVI application **Smart Access Anywhere** must be downloaded on the PC which will be connected to the SmartOTDR remotely.



NOTE

It is not necessary to have administrator privileges to install the VIAVI application on PC. This application is just saved on PC.

- 1 On PC, open an internet browser page and type the following address: `http://smartaccess.updatemyunit.net`
 - 2 Click on the link **SmartAccessAnywhere_Vxx.xx.xx.zip**
 - 3 Select **Save** in the dialog box.
 - 4 Open the directory into which has been save the zip file and unzip files into a directory
 - 5 Open the directory and double click on **SmartAccessAnywhere.exe**
- The Smart Access Anywhere application opens:

Figure 47 Smart Access Anywhere: Connection page

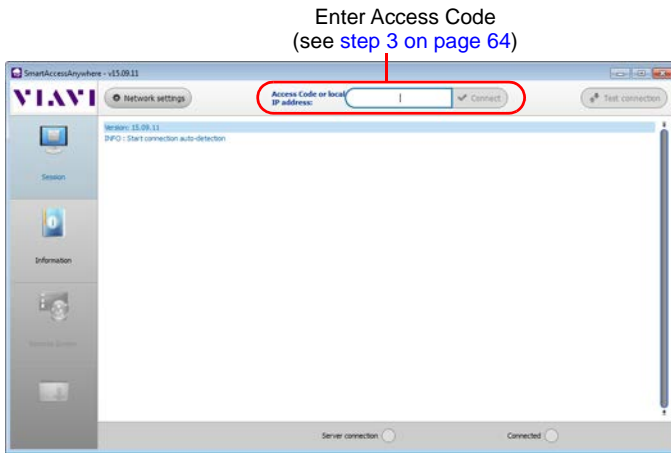

If the software version is not the last one available, a message displays, on the upper part of the screen to indicate the latest version available can be downloaded at the address: <http://smartaccess.updatemyunit.net>.

Figure 48 Warning message of a new version available

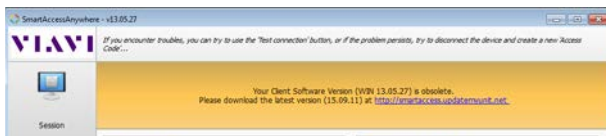

Downloading the VIAVI application on Tablet/Smartphone

The VIAVI application **Smart Access Anywhere** can be downloaded on a Smartphone or tablet which will be connected to the SmartOTDR remotely.



NOTE

It is not necessary to have administrator privileges to install the VIAVI application. This application is just saved on the smartphone or tablet.

- 1 On Smart device, open an internet browser page and type the following address:
`http://smartaccess.updatemyunit.net`
- 2 Click on the link **SmartAccessAnywhere_Vxx.xx.xx.apk**
The downloading starts.
Some security messages can be displayed.
- 3 Follow the process on the Smart device to confirm the installation of the application on the instrument.
- 4 Once the installation is completed, the icon appears on Tablet/Smartphone.
- 5 Click on the icon to launch the SmartAccess Anywhere application.

Launching the SmartAccess Anywhere application

Once connection is configured, the SmartAccess Anywhere application can be launched

On SmartOTDR



- 1 On the **Home** page, select the **SmartAccess** icon .
As soon as the icon is selected, the SmartOTDR begin to connect to SmartAccessAnywhere Server.
- 2 Once connection is established with the server, the SmartOTDR displays a message with the code to be used to access to the equipment remotely.

Figure 49 Access code displayed



- 3 Note this access code and transfer it to the distant user, who will access the unit remotely.
- 4 Press **OK** to hide the message.

On the distant PC

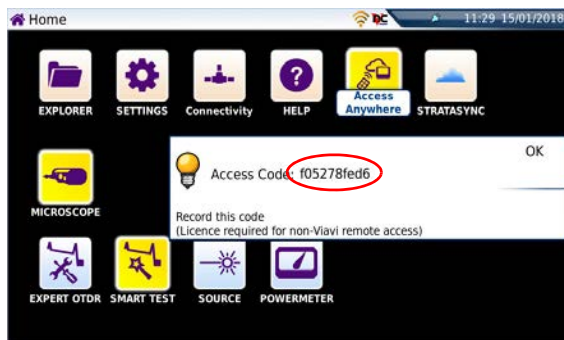
- 1 On the PC of the distant user, once the application is launched, enter the Access Number on the upper part of the screen.
 - 2 Click on **Connect** to validate
- The following screen displays:

Figure 50 Smart Access Anywhere: Home page

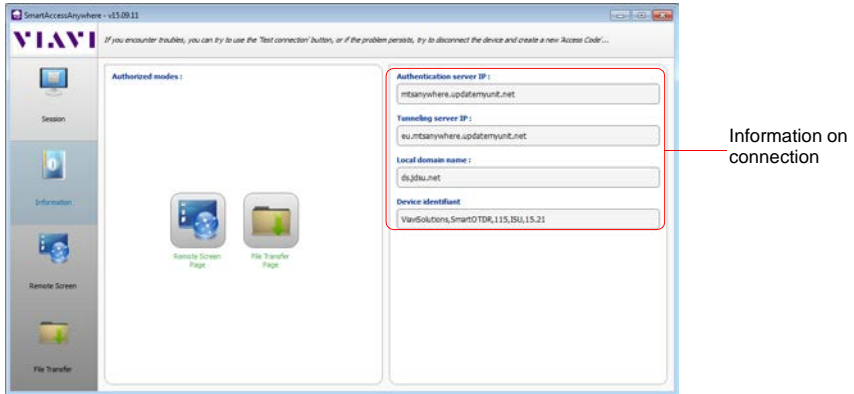

After remote upgrade or reboot, please wait for more than 2 minutes before re-starting the link between the PC and the unit with SmartAccessAnywhere.

Using Remote screen and File Transfer applications

Once the Introduction page is displayed, the user can work on distant SmartOTDR:

- transfer the interface to work on the unit (perform acquisition, configure the equipment...)
- transfer files from the equipment toward the PC, and vice-versa.

Transferring the interface onto the PC/Smartphone/Tablet

To display the remote SmartOTDR onto the PC:

- 1 On the Introduction page, click on



or



Remote Screen Page

On the left menu, click on

Remote Screen

The current screen of the SmartOTDR displays:

Figure 51 Smart Access Anywhere: Remote screen

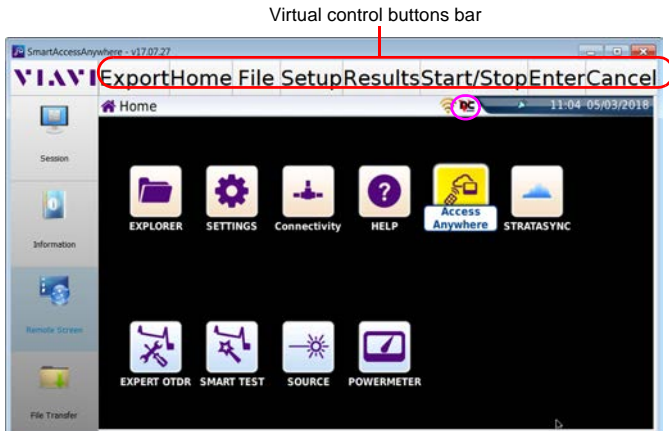

The VNC icon  on the upper banner of the unit indicates the remote screen is active.

- 2 On the upper part of the screen, the virtual control buttons bar is permanently displayed and allows to emulate hard keys.
You may click on any of these buttons to obtain exactly the same results than using the hard keys on the front panel of the SmartOTDR.
- 3 You can use keyboard mouse of the PC to control the SmartOTDR (see [“Equivalence between the keyboard and SmartOTDR”](#) on page 78).

Transferring files

To work on files (onto PC and onto unit):

- 1 On the Introduction page, click on .

or

- On the left menu, click on .

The file Explorer on PC and the one of the SmartOTDR displays:

Figure 52 File Transfer page

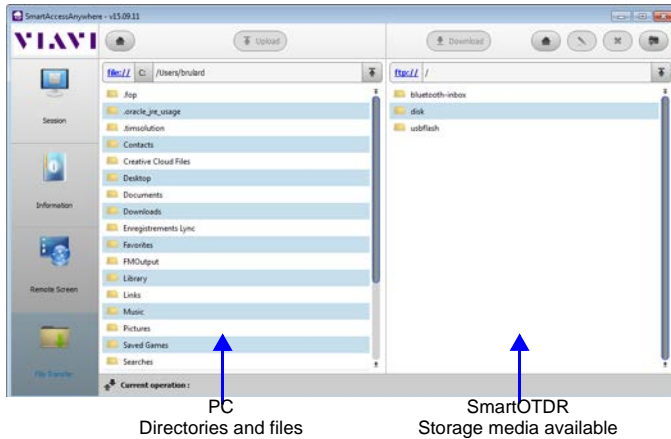

- 2 Double-click on one directory/storage media to display the contents (directories / sub-directories / files)

Navigation buttons

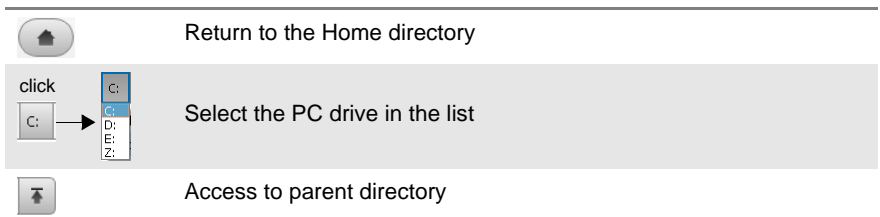

Transferring files from PC to SmartOTDR

- 1 On the SmartOTDR explorer, select the storage media, and if wished the (sub-)directory into which file will be transferred.
- 2 On the PC file explorer, select the file to be transferred
- 3 Click on the button **Upload**  .

At the bottom of the screen, a new banner displays with information on file transfer:

Figure 53 Information on file transfer

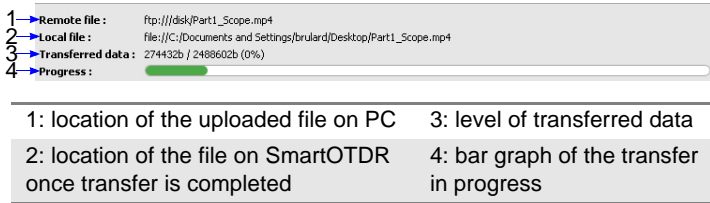

Only one file can be uploaded from PC to SmartOTDR at the same time.

Once transfer is completed, the banner disappears and the transferred file is underlined in blue on SmartOTDR explorer.

Transferring files from SmartOTDR to PC

- 1 On the PC explorer, select the storage media, and if wished the (sub-)directory into which file will be transferred.
- 2 On the file explorer of the SmartOTDR, select the file to be transferred.
- 3 Click on the button **Download**  .
A dialog box open, allowing to modify the location on PC of the file.
- 4 Select the directory into which file will be saved.
- 5 Press **Save** to start the transfer

Under both file explorers, a new banner displays with information on file transfer (see [Figure 52 on page 67](#)).

Once transfer is completed, the banner disappears and the transferred file is underlined in blue on PC explorer.

Working with files and directories on SmartOTDR

Renaming file or directory

- 1 Select a file/directory stored on the SmartOTDR hard disk or USB key.
- 2 Click on .
- 3 In the new dialog box opened, enter a new name for the file/directory, **keeping the file extension**.
- 4 Press **OK** to validate.



Deleting file

- 1 Select a file stored on the SmartOTDR hard disk or USB key.
- 2 Click on .
- 3 In the new dialog box opened, press **Yes** to confirm the deletion (or **No** to keep the file).



Creating a new directory

- 1 Select the storage and, if wished, the directory into which the new directory will be stored.
- 2 Click on .
- 3 In the new dialog box opened, enter a name for the new directory (*newdir* is given by default).
- 4 Press **OK** to validate.
The new directory is automatically created at the location selected.



Connection information and settings

Displaying session information

At any time during application use, the information about the session in progress can be displayed.

- 1 Press **Session** menu key on left of the screen .
A screen as the following one displays:





Figure 54 Session page

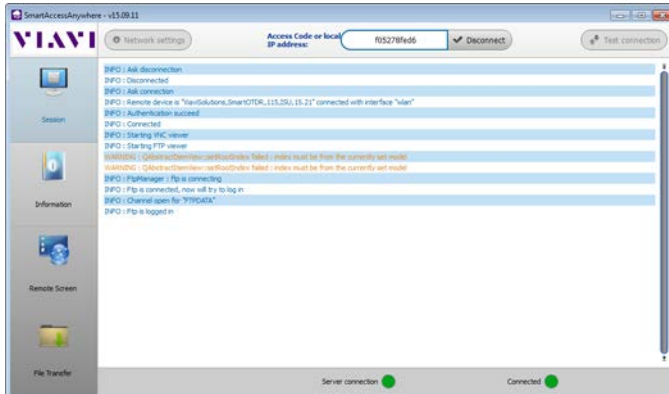

This page gives information on connection «in real time».

Modifying connection settings

To modify the settings for connection to internet:

- 1 Press **Session** menu key on left of the screen 
- 2 Disconnect from application pressing 
- 3 On the session screen (see [Figure 54 on page 70](#)), press button 

The following screen displays:

Figure 55 Connection settings

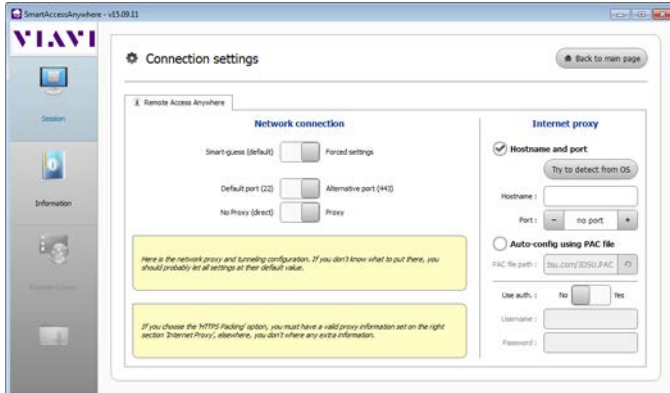

By default, the connection is defined to **Smart-guess (default)**.



- 4 To modify the current parameters, select **Forced settings**.



The parameters for Port configurations turn automatically active.

- 5 Modify, if necessary, the port used: **Default port (22)** is selected by default
- 6 Select **Alternative port (443)** if necessary
- 7 If the parameter **Alternative port (443)** is selected, you can defined if the proxy is used or not in the following parameter.

The **Internet proxy** configuration is available exclusively if the port selected is **Alternative port (443)** and if the **Proxy** is selected..

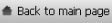

It is recommended to configure parameters of connection with your local network administrator, if the default parameters need to be modified.

- 8 Once configuration is completed, press  .
The **Home** page displays (see [Figure 50 on page 65](#)).

Testing connection

Before entering the Access code to activate the application, the connection to internet can be tested from displayed screen.

- 1 Open the Smart Access Anywhere application on PC
- 2 Press  button

The test is automatically launched

- 3 Press  to display logs in real time

Once completed, the results for connection display:

Figure 56 Test results

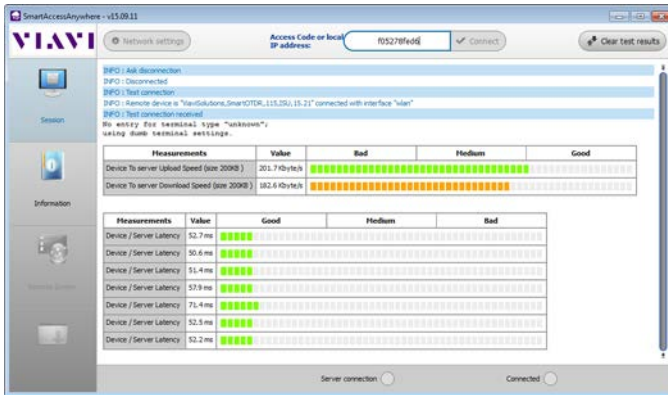

The screen displays, in two different tables:

- the Upload and Download speed (in Kbyte/s) from Device to server.
 - the Latency between Device and server (in ms).
- 4 Press  to delete the current table, and retest connection if wished.
 - 5 If connection is valid, enter the access code and establish connection (see ["Launching the SmartAccess Anywhere application"](#) on page 63 - ["On the distant PC"](#) on page 64).

Data Transfer

The SmartOTDR enables to transfer files, from or toward the product using Wifi, Bluetooth or Ethernet connection.

Transferring files via Bluetooth

Once the connection has been established with a bluetooth device:

- 1 On the **Home** page, press **File Explorer** key to go in the File Explorer.
- 2 Select the file(s) to be transferred from the Platform toward the PC.
- 3 Push **Export > Send by Bluetooth** menu keys Send by Bluetooth.

A confirmation message displays once the transfer is completed.

Figure 57 Confirmation of files sending

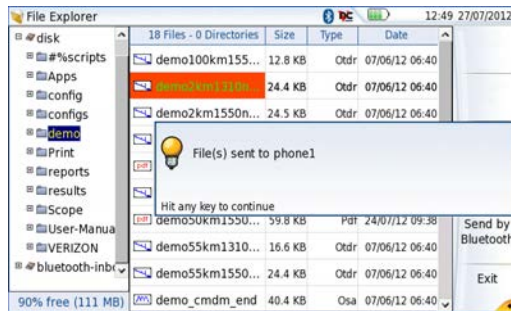

You can also transfer file(s) from the bluetooth device toward the Platform.

In this case, the files received will be stored in a storage media created automatically on the Platform: *bluetooth-inbox*.

Figure 58 Confirmation of file receiving



WARNING

The files stored in bluetooth-inbox will be lost once the SmartOTDR is switched off. Copy/Paste the files to keep toward another storage media (disk, usb key...).

Transferring files to/from a PC via WIFI or Ethernet

Once connection is established between the Platform and the PC:

- 1 On the PC, use an FTP client, and access to internal memory via an internet browser page (I.E, Mozilla Firefox...).
- 2 In the address bar, type the following address (10.33.16.229 being the IP address of the SmartOTDR defined when the connection was configured):
`ftp://mts1000:JDSU@10.33.16.229/disk/`
This allows to access to internal memory.
`ftp://mts1000:JDSU@10.33.16.229/usbflash/`
This allows to access to the contents of the USB memory stick connected to the SmartOTDR.
- 3 If an identification is required, enter:
 - User name: mts1000
 - Password: JDSUThe PC then displays the contents of the internal memory or of the USB memory stick from the SmartOTDR.

Figure 59 Internal memory of the SmartOTDR

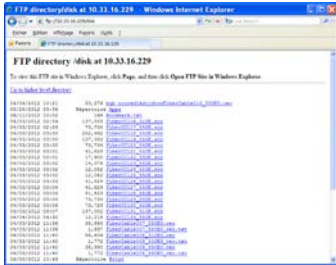

Internal memory open via Internet Explorer

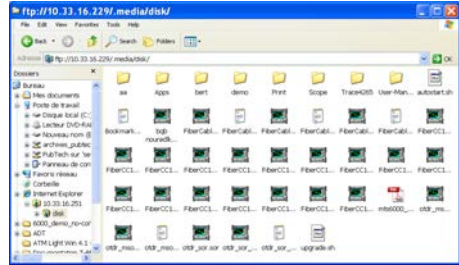

Internal memory open via Windows Explorer

- 4 If internal memory of the Platform is accessible via Internet Explorer (or any other explorer), right click on one file and click on **Save target as...** to transfer file onto the PC.

If internal memory of the Platform is accessible via Windows Explorer, select one / several files and click on **Copy**, then click on **Paste** on PC to transfer file(s).

Transferring files using Cloud Storage

Once connection between SmartOTDR and cloud storage server is successfully established (see [“Configuring and connecting to Cloud Storage on the SmartOTDR” on page 57](#)), the files can be transferred from one Platform to the other.

- 1 Press **HOME** hard key.
- 2 Press **Explorer** on the **Home** page

In the **Explorer** page, a new storage media is available: **cloud-storage**.



The cloud-storage media is not available when File Explorer is opened from a FO application.

- 3 Transfer the files from the disk or USB memory stick of the SmartOTDR toward the cloud storage or vice-versa:
 - a Select the file(s) to be transferred
 - b Press the **Edit > Copy** or **Cut** menu keys
 - c Select the storage media (and the directory) into which files must be copied.
 - d Press **Paste** menu key

Figure 60 File Explorer with cloud storage

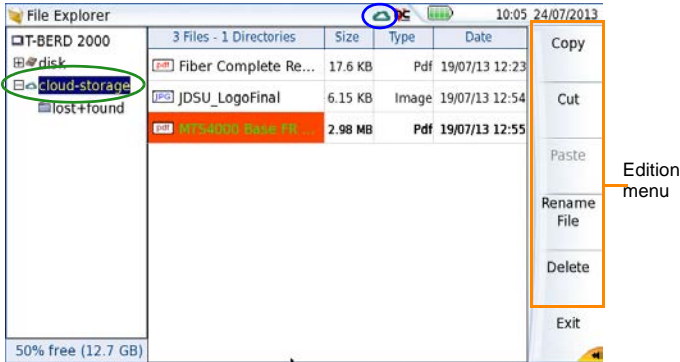

The cloud storage is automatically disconnected once the SmartOTDR is switched off. Reconnect from the System Settings page of the SmartOTDR after the Platform restart.

VNC

The SmartOTDR can be used in combination with a PC in order to transfer the Interface onto a PC.

The transfer of the interface can be done using a VNC window on PC.



For an intensive use of the deport screen or when it is used via a WAN network, it is strongly recommended to use a dedicated VNC client. The VNC clients recommended are Tight VNC (V 1.2.9 or later) and Real VNC (V 4.1.1 or later).

Transferring the interface on a PC via WIFI or Ethernet

Once the connection is established between the SmartOTDR and the PC, proceed as follow:

- 1 Install a VNC viewer on your PC and open a VNC window.
 - 2 Considering 10.33.22.49 is the IP Address of the SmartOTDR (as shown [Figure 39 on page 52](#)), enter this IP address in the VNC window
 - 3 Press **Enter** to validate.
- The screen of the SmartOTDR appears offset on your PC.

Figure 61 VNC window

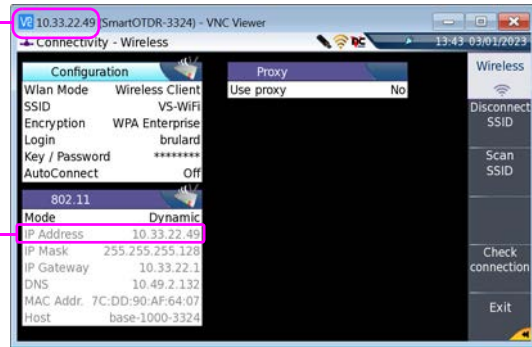

NOTE

Once Remote screen is accessible via VNC, the icon  displays on the upper banner of the screen until the connection is cut or the SmartOTDR is switched off.

Virtual control buttons bar

It is possible to emulate hard keys with Virtual Control buttons. This virtual control bar is especially useful when the SmartOTDR screen is exported on a remote PC.

To display those buttons, click once on the top of the screen in the status bar, at the same height than the date and time.

Figure 62 Virtual control buttons bar



The virtual control buttons bar is displayed during a few seconds. You may click on any of these buttons to obtain exactly the same results than using the hard keys on the front panel of the SmartOTDR.

Equivalence between the keyboard and SmartOTDR

The PC keyboard can replaced all the buttons and keys of the SmartOTDR except the **ON/OFF** button:

- The menu keys to the right are replaced by the function keys **F1** to **F6**.
- The buttons below the screen are equivalent to **Ctrl + a** letter (see table below).
- The direction keys have the same function on the external keyboard and on the SmartOTDR.

Function on the SmartOTDR	External keyboard
HOME	Ctrl + H
SET-UP	Ctrl + U
FILE	Ctrl + F
RESULTS	Ctrl + R
START/STOP	Ctrl + S
EXPORT	Ctrl + P ^a
◀ ▶ ▲ ▼	← ↑ → ↓
Menu keys 1 to 6 (from top to bottom)	F1 → F6
Validate a selection	Entrée/Enter
Deselect a function on the Home page	Escape/Echap.

- a. The Export function is available directly on the SmartOTDR pushing simultaneously the left and right arrow keys.



NOTE

Those equivalences are also valid with a keyboard directly connected to the SmartOTDR via one USB port.

Stratasync

Principle and prerequisites of the Stratasync

Stratasync is a new solution that provides network operators with an agile and centralized way to manage and analyze data from thousands of deployed VIAVI test instruments directly from the cloud.

StrataSync is a hosted, cloud-based software application that provides VIAVI instrument asset, configuration, and test-date management.

StrataSync improves technician and instrument efficiency.

StrataSync allows to:

- Manages and tracks test instruments
- Collects and analyzes results from the entire network
- Informs and trains the workforce

Figure 63 Principle of the Stratasync application

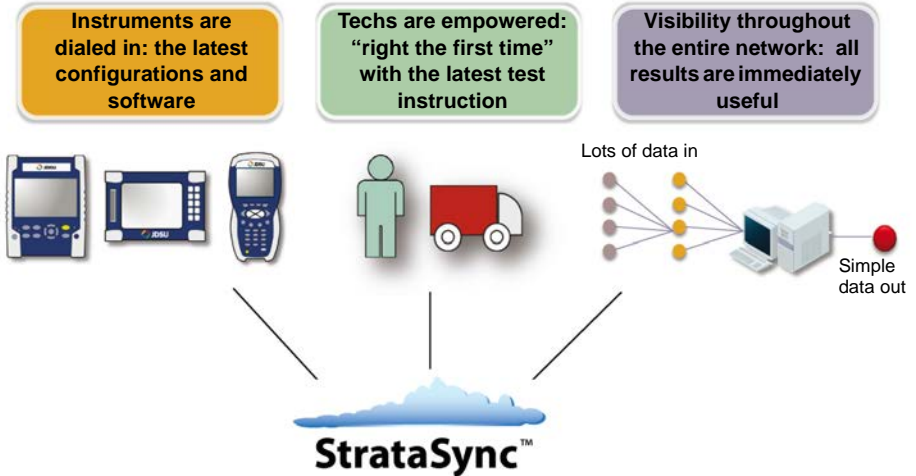

Pre-requisites for using the Stratasync with the SmartOTDR

The user must have subscribed to Stratasync, and by consequence, he must have acquired an **account Identifier** and a **password**.

The Ethernet and Proxy parameters must have been correctly configured in the System Settings page of the SmartOTDR (see [“Ethernet > Mode” on page 55](#) and [“Proxy > Use proxy” on page 56](#)).

Configuring and synchronizing the SmartOTDR

The SmartOTDR can be configured to be synchronized with the Stratasync.



- 1 On the **Home** page, press **Connectivity**.
- 2 Check the configuration of the **Ethernet** and **Proxy** parameters (see [“Configuring the SmartOTDR via Ethernet” on page 54](#)
- 3 In the **Connectivity** windows, press **Stratasync** 
- 4 Configure the Stratasync parameters:
 - a In the **Server Type** parameter, the **Viavi Server** is selected by default and it is recommended to keep this parameter.
However, the user can select if necessary the **Server Name** parameter and enter the name in the following parameter.
 - b In the **Account ID** parameter, enter the same identifier as the one used to access to Stratasync.
 - c The **Technician ID** parameter is automatically fulfilled after synchronization (if it has been defined by the administrator of the Stratasync)
 - d To upload the files from a directory onto the SmartOTDR toward Stratasync, select the parameter **Upload from** and press right arrow key to enter the directory path (example: `disk/Stratasync`). The directory Stratasync is defined by default.

Figure 64 Stratasync configuration

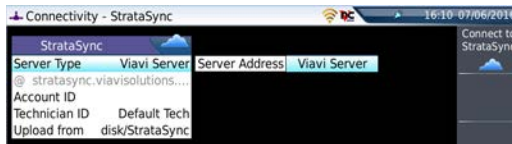

Connecting the SmartOTDR to Stratasync

Once SmartOTDR is configured in the **System Settings** page:

- 1 In **Home** page, press Stratasync icon .

The synchronization with Stratasync starts

The icon  displays on the upper banner of the SmartOTDR during synchronization.

Once the icon is no more displayed, this mean that the synchronization is completed.

- 2 For the first synchronization only, a message displays on the SmartOTDR to indicate the addition of the equipment in Stratasync.

Figure 65 First synchronization - Message on SmartOTDR

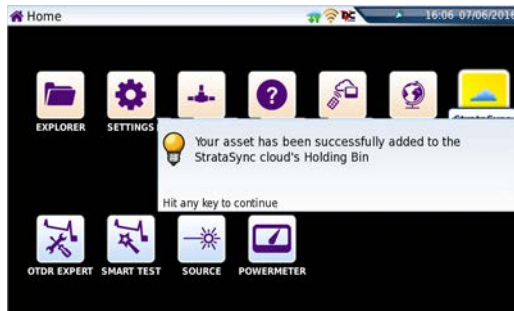

The SmartOTDR is now available in Stratasync.

File management

This chapter describes the files management using a SmartOTDR.

The topics discussed in this chapter are as follows:

- [“File Explorer Overview” on page 84](#)
- [“Directories and Files selections” on page 84](#)
- [“Directories & Files editing functions” on page 86](#)
- [“Working with directories and files from the explorer” on page 87](#)
- [“Creating a screenshot” on page 89](#)
- [“Merging pdf or txt files” on page 90](#)
- [“Storage media” on page 91](#)

File Explorer Overview

To reach the File Explorer page

- On the **Home** page, select the **File Explorer** icon.
The File Explorer page displays.

Figure 66 File Explorer page

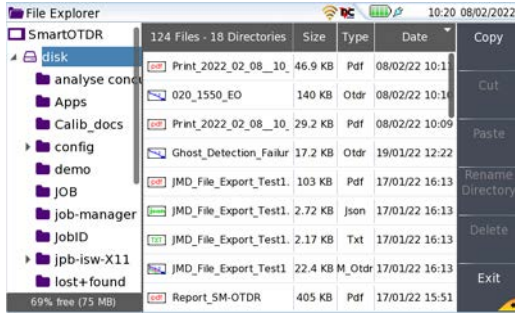

Directories and Files selections

Directory selection

To select a directory from the explorer page:

- 1 Press on the directory that must be selected on the left of the screen.
The list of files the directory contains displays on the right side of the screen
The selected directory is underlined in blue
- 2 Touch the arrow at the left of the directory name, or press validation hard key , to display the sub-directories if any.

Figure 67 Directory selection



Files selection

To select one or several files from the explorer page:

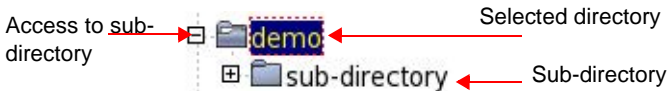
- 1 Press on files that must be selected.
or
To select a list of files using the keys of the Platform:
 - a Select and validate the first file of the list (underlined in red)
 - b Set the cursor on the last file of the list (underlined in blue)
 - c Maintain the right direction key ► pushed until all the files are selected.
- or
Touch **Select all** menu key to select all files into the directory.



NOTE

The last selected file is underlined in red and the previous one(s) selected is/are underlined in blue.

Figure 68 Example of files selection

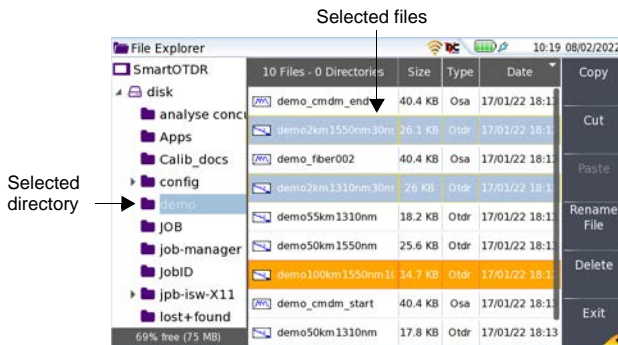

Directories & Files editing functions

Copy/Cut & Paste files/directories

To copy (cut) one or several files, or one directory, and paste them in another place:

- 1 Select the directory / the file(s) (see [“Directories and Files selections” on page 84](#)).
- 2 Press **Edit** menu key
- 3 Press **Copy** to keep the directory / file(s) to their initial location.
or
Press **Cut** to delete the directory / file(s) from their initial location
- 4 On the left of the screen, select the directory; or select the new storage media.
- 5 Press **Paste** menu key.

Renaming a directory / file

- 1 Select the directory / file to be renamed (see [“Directories and Files selections” on page 84](#)).
- 2 Press **Edit > Rename Directory** or **Rename File**.
The Edition keypad displays.

Figure 69 Edition keypad for renaming file



- 3 Press **Clear** if you wish to delete the entire name
- 4 Enter a new name for the directory / file.
- 5 Press **Enter** to validate the new name.

Deleting a directory / file

- 1 Select the directory or file(s) to be deleted (see “[Directories and Files selections](#)” on page 84).
- 2 Press **Edit > Delete**.
A confirmation dialog box displays.
- 3 Press **Yes** to delete the selected directory or file(s).
Press **No** to cancel the deletion.

Working with directories and files from the explorer

Creating a directory

To create a new directory from the explorer page:

- 1 Check the cursor is set on the left of the screen
- 2 Select the storage media into which the directory must be created
- 3 If you want to create a sub-directory, select the directory into which it must be created.
- 4 Press the right menu key **Create Directory**.
The edition keypad displays
- 5 Enter a name for this directory
- 6 Press **Enter** key to validate the new directory

Opening files





Once a file is selected, press **Load** menu key.







Opening several files at the same time can be done exclusively with trace files (example: all OTDR trace files if a reference trace has been defined). Other type of files (PDF, TXT...) must be open one by one. If different types of files have been selected in the Explorer, only the last one selected will open.

File Types

For files recognized by the SmartOTDR, the types are symbolized by icons. E.g.

Icon	Type of FO file
	OTDR file (.SOR extension)
	Multi OTDR file (.MSOR extension)
	FTTH OTDR file (.CSOR extension)
	Power Meter file (.LTS extension)

Icon	Type of file
	PDF File (.PDF extension)
	Text file (.TXT extension)
	License file (.LIC extension)
	CSV file (.CSV extension)

Sorting files

Whether files are selected or not, the key **Sort** allows to access to a sub-menu allowing to sort the file according to pre-defined parameters:

- **Sort by name:** the files display in an ascending order (from A to Z). If you press once again on the key, the files display in a descending order (from Z to A).
- **Sort by size:** by clicking once on this key, the files display from the smallest to the heaviest one. Pressing a second time allows to sort the files in opposite order.
- **Sort by type:** pressing once on this key; the SmartOTDR displays files in an ascending order (the file type A to file type W). By pressing again, the SmartOTDR displays the files in opposite order.
- **Sort by date:** pressing once on this key; the SmartOTDR displays files from the more recent to the less one. By pressing again on key, the Platform displays files from the older to the more recent one.



NOTE

You can also sort files pressing on the column titles in the files list

Creating a screenshot

You can create captures of what is displayed on the screen, directly from the SmartOTDR and save it into a pdf file.

Taking a screenshot

Once the screenshot parameters are configured:

- 1 Reach the display which will be saved as a screenshot in a file.
- 2 If necessary, make modifications on this display (example: zoom on trace...)
- 3 Press simultaneously the left and right arrow keys ◀ ▶ for about 5 seconds or

Touch the upper banner of the screen and, in the virtual control buttons bar, press **Export** key

The icon  displays until the end of process.

- 4 Press the **FILE** key to find the PDF file in the Explorer.
For trace results, the file is saved in the same directory than the file used for screenshot., or in the last directory selected.
For other page open and used for a screenshot, the file is saved in the directory **Print** into the disk.

Name of the screenshots files

The screenshot is saved in a file, which is automatically named as follow:

- *Print_date (year/month/day)_time (hour/minute/second).pdf*

Figure 70 Example of screenshot, open on the SmartOTDR

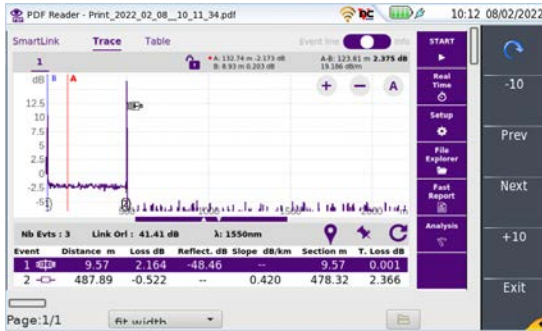



Merging pdf or txt files

In the Explorer page, two pdf/txt files or more, generated via the results traces can be merged in one pdf file.

- The pdf files that can be merged are those generated via the **Fast Report** key on trace results page or via the **Export** key on the upper banner (or left and right arrow keys).
 - The txt files that can be merged are those saved with the results trace (see OTDR Application User Manual).
- 1 In the Explorer, select the two or more pdf/txt files generated
 - 2 Press **Export** menu key
 - 3 Press **Merge** key

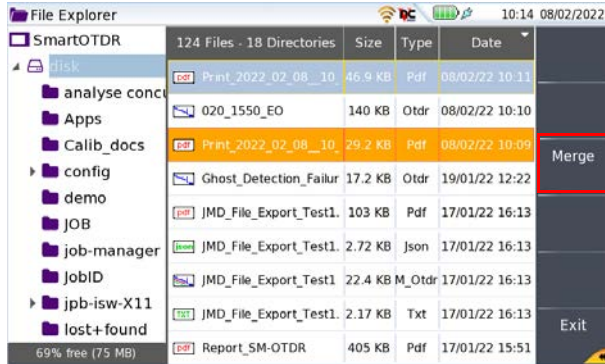
Figure 71 Files selection and Merge key



The icon  is displayed during merging process.

After a few seconds, the files are merged in one pdf/txt file, which name by default is: *merged_year_month_date__hour_min_sec.pdf/txt*.

The file is automatically saved in the same directory as the one where files have been selected.

It gathers all results from pdf/txt files selected (and traces for pdf file), in one single pdf file of several pages (1 results screen per page, if the results table does not exceed one page).



NOTE

Once merged file is saved, it can be renamed in the Explorer (see [“Renaming a directory / file” on page 86](#)).

Storage media

For saving or recalling data, the SmartOTDR offers a wide choice of media, both built-in and external.

Free space on selected media is clearly displayed at the bottom of the left panel.

Storage media built into the SmartOTDR

The SmartOTDR is delivered with an internal memory, which maximum capacity is of 2GB (with a minimum of about 128 Mb are available for data storage).

External USB storage media

The SmartOTDR is equipped with 2 USB ports as standard. One of these can be used to connect an external storage medium, in particular a USB memory stick.



NOTE

Although two USB ports are present, it is not possible to use simultaneously more than one external USB storage medium.

USB memory stick connection

- 1 Insert the USB memory stick in one of the SmartOTDR's USB port.
A sound is emitted to confirm the successful insertion and recognition of a USB memory stick.
Then, the icon  is displayed in the upper banner to inform the user the USB stick is ready to be used.



When a file is moved in the explorer of the Platform, the end of the move on the screen does not mean that writing of data into the memory is complete. Some data may still be in a writing process if the storage unit is removed prematurely.

USB memory stick disconnection

- 1 Before disconnecting the USB memory stick, always select a storage device different from usbflash (select disk for example) in the explorer.
- 2 Make sure you no longer have any running applications using the usbflash storage media.
- 3 The user must push the **EJECT USB** key, available in **File Explorer**.
The icon becomes  to indicate it can be removed safely. In this state, the USB stick cannot be used anymore

The USB memory stick can then be disconnected from the Platform USB port.



NOTE

The USB memory stick can also be removed using the **Expert Tools > Media Utilities** menu, accessible via the **System Settings** page.

See [Chapter 11 “Maintenance and Troubleshooting”](#) if any problem occurs with the USB memory stick

Abbreviations for storage media

The abbreviations used in the explorer for the different storage media are:

Abbreviation	Storage medium
disk	Internal flash memory
usbflash	USB memory stick
bluetooth-inbox	Bluetooth storage media (option) ^a
cloud-storage	Cloud storage media available on PC

a. The files stored in bluetooth-inbox are lost when the SmartOTDR is switched off.

Technical specifications

This chapter contains the technical specifications of the SmartOTDR mainframe.

The topics discussed in this chapter are as follows:

- [“General specifications” on page 96](#)
- [“Characteristics of the Source \(standard\) and Power Meter \(optional\)” on page 99](#)
- [“Characteristics of the options” on page 100](#)
- [“Characteristics of the OTDR” on page 101](#)

General specifications

Display specifications

Screen

- Backlight high visibility color capacitive touchscreen
- Size: 5 inches

Resolution

- 800 x 480 pixels

Memory

Standard memory: internal memory, with a capacity of 2GB (with a minimum of about 125 Mb are available for data storage).

Input/Output

- Two USB 2.0 host ports.
- One Mini USB 2.0 device
- Built-in buzzer
- Built-in WIFI/Bluetooth (BLE) (optional)

Battery

The instrument is supplied with one Lithium-Polymer battery.

Li-Po Battery charging time

If the battery is completely discharged, the time taken to recharge is:

- approximately 5 hours, if the apparatus is not in use (**Charge** indicator solid red)
- about 10.5 hours if the instrument is used during charging (**On** indicator lit in fix green, **Charge** indicator lit in solid red).

Endurance of the SmartOTDR with battery

Measurement conditions:

- at +25 °C,
- at full battery capacity (4.8 Ah),

Li-Polymer Battery

Conditions of use	Endurance
According to Telcordia GR-196-CORE recommendation: Normal conditions, with normal backlight, 3 acquisition of 30 seconds per quarter of hour, auto off	up to 20 hours
Under continuous acquisition, with high screen backlight: with a E136FB SmartOTDR	Up to 5h45

Mains adapters

	Standard Mains Adapter
Input	100-240 V, 50-60 Hz
Output	12V DC 2 A max
Compliance	EN 60950

Supply or Power assigned in AC and in DC: 24 W

Dimensions - Weight

Dimensions

175 x 138 x 57 mm (6.9 x 5.4 x 2.4 in)

Weight

About 900 gr (1.98 lb)

Environment

Temperature

- Operating temperature range: -20°C to +50°C (-4°F to +122°F)
- Operating temperature range with guaranteed specifications: 0°C to +40°C (+32°F to +104°F)
- Storage: -20°C to +60°C (-4°F to +140°F)

Humidity

- 5 to 95% without condensation

EMI/ESD

- CE Compliant (EN61326-1)
- FCC 47-1 Part 15 Compliant

Drop test

In accordance with the Telcordia GR-196-CORE recommendations, the SmartOTDR resists the following test:

- 6 impacts dropped from a height of 76 cm on a pinwood floor of 5 cm thickness (1 impact on each of its 6 sides, with power off).

Shocks

The SmartOTDR resists the following test:

- 3 shocks per axis along each of the 3 axes, with power off.
- Impacts of 15g, 1/2 sine, duration 11 ms, at 10 second intervals.

Bumps

The SmartOTDR resists the following test:

- 1,000 bumps per axis along each of the 3 axes, with power off.
- Jolts of 15g, 1/2 sine, duration 6 ms, at 1 second intervals.

Vibration

The SmartOTDR resists the following vibration tests:

- Complete test comprising 6 cycles along each of the x, y and z axes.
- One cycle of 5 to 200 Hz and back to 5 Hz with a sweep duration of one minute/octave.
- 3 mm amplitude displacement test, for the range 5 Hz to 15 Hz.
- 3g acceleration test for the range 16 Hz to 200 Hz.

Flammability

The SmartOTDR housing (in ABS, type V0) does not propagate fire.

Characteristics of the Source (standard) and Power Meter (optional)

Source

- Output Power Level¹: -3.5 dBm
- Stability long term (8h): $\pm 0.05 \text{ dB}^2$

Broadband power Meter (through non-filtered OTDR port)³

Specifications given for 25°C, after 20 minutes stabilization and zero setting.

- Calibrated wavelengths: 1310 / 1490 / 1550 / 1625 / 1650 nm⁴
- Selectable Wavelengths: 1310 to 1650 nm
- Tone detection: 270Hz, 330Hz, 1 kHz, 2 kHz and TWINTest
- Max Input Power Level: +10 dBm
- Measurement Range: -55 to 0 dBm
- Accuracy at calibrated wavelengths: $\pm 0.5 \text{ dB}$ (at -30 dBm)⁵

1. +/- 1 dB

2. After 30min light source stabilization time

3. Not available on 118FA65 version

4. 1625 nm ,not calibrated on 138FB65 version

- Display resolution: 0.01 dB / 0.01nW
- Linearity: ± 0.5 dB⁶

Dual-Band Power Meter (through filtered OTDR port) - 118FA65PPM version only

- Calibrated Wavelengths : 1310 / 1490 / 1550 / 1625 / 1650 nm
- Selectable Wavelengths :
 - Power Meter Mode (1 channel): 1310 to 1500 nm and 1540 to 1650 nm
 - PON Power Meter Mode (2 channels): 1310 / 1550 nm ; 1490 / 1550 nm ; 1490 / 1577 nm
- Tone detection : 270 Hz, 330 Hz, 1 kHz, 2 kHz, and TWINTest
- Max Input Power Level: +26 dBm???
- Measurement Range:
 - 1310 to 1500 nm : -35 to + 5 dBm
 - 1540 to 1650 nm : -35 to +23 dBm
- Accuracy at calibrated wavelengths: +/- 0.5 dB (at -30 dBm)³
- Display resolution: 0.01 dB / 0.01 nW
- Linearity: +/- 0.5 dB⁵
- Channels isolation from external source:
 - 1310/1490: > 40dB
 - 1550 to 1650: > 20dB

Characteristics of the options

VFL

- Wavelength: 650 nm
- Length of fiber: up to 5 km
- Class 2 laser (standards EN60825-1 and FDA21 CFR Part 1040.10).

5.Except 1650 nm

6.from -50 dBm to -5 dBm

Bluetooth and WIFI

- WIFI: standard IEEE802.11n
- Bluetooth Option
 - Class 2
 - Range: up to 20 meters
 - Bluetooth V2.1 + EDR

Characteristics of the OTDR

OTDR Optical Interfaces

Interchangeable optical connectors: SC delivered standard, LC and FC also available

OTDR Optical characteristics

Laser safety class (21 CFR)	Class 1
Distance units	Kilometer, meter, feet, and miles
Group index range	1.300000 to 1.700000 in 0.00001 steps
Number of data points	Up to 256,000 data points
Distance measurement	Automatic or dual cursor
Display range	0.1 km to 260 km for single-mode
Cursor resolution	1 cm
Sampling resolution	4 cm for single-mode
Accuracy	$\pm 1 \text{ m} \pm \text{sampling resolution} \pm 1.10^{-5} * \text{x distance}$ (Excluding group index uncertainties)

Characteristics of reflectometry measurements

Distance measurement

- Automatic or Dual cursor

- Distance displayed takes into account the calibration of the refractive index of the fiber.
- Index adjustable from 1,30000 to 1,70000 in steps of 0,00001
- Resolution of display: 1 cm max.
- Resolution of cursor: 1 cm max.
- Spacing of measurement points: from 4 cm, with up to 256 000 acquisition points.
- Accuracy: $\pm 1\text{m} \pm \text{sampling resolution} \pm 1 \cdot 10^{-5} \times \text{distance}$ (excluding errors of calibration of refractive index of the fiber).
- Display span: 0.1 km m to 260 km for single mode

Attenuation measurement

- Automatic, manual, 2-point, 5-point, and LSA
- Resolution of display: 0,001 dB
- Resolution of cursor: 0,001 dB
- Linearity: ± 0.04 dB/dB for single mode
- Display span: 1.25 dB to 55 dB

Reflectance / ORL Measurement

- Resolution of display: 0,01 dB
- Accuracy: ± 2 dB

Automatic measurement

- Automatic measurement of all the elements of the signal. Slope measurement by least squares or 2 points of measurement.
- Display threshold of faults:
 - 0 to 5.99 dB in steps of 0.01 dB for event thresholds
 - -11 to -99 dB in steps of 1 dB for the reflectance
 - 0.01 to 5.99 dB in steps of 0.01 dB for attenuation
- Display of slope and attenuation for a segment of fiber.
- Display of the position of a fault and of attenuation.
- Display of the reflectance of the fault.
- Display of ORL

Manual Measurement

- Measurement of slope between the cursors.

- Measurement of attenuation between two segments of fiber.
- Measurement of reflectance of a reflecting element.
- Measurement of ORL between the two cursors.
- Measurement of splice by 2 or 5 points method

Typical specifications

Typical values, measured at 25°C unless specified.

	100A Series	100AS Series	100B Series
Central Wavelength^a	1310 nm ± 20nm 1550 nm ± 20nm filtered 1650 nm ± 20 nm	1310 nm ± 20nm 1550 nm ± 20nm	1310 ± 20nm 1550 ± 20nm filtered 1625 nm ± 20nm filtered 1650 nm ± 20nm
Cut Wavelength range on live port (filtered)	1290 - 1580 nm Isolation > 45 dB		E136FB Module 1290 - 1580 nm Isolation > 45 dB E138FB65 Module 1260 - 1620 nm Isolation > 45 dB
Typical RMS Dynamic Range^b	37 / 35 / 32 dB	30 / 30 dB	40 / 40 / 41 dB
Distance Range	Up to 260 km		
Pulse width	5 ns to 20µs		3 ns to 20µs
Event Dead Zone^c	1.35 m		0.90 m
Attenuation Dead Zone^d	4 m		2.5 m
Splitter Attenuation Dead Zone	40 m after 12dB splitter loss ^e	NA	45 m after 15dB splitter loss ^f

a. Laser, at 25° C and measured at 10 µs

b. Typical value corresponding to the one-way difference (in dB) between the extrapolated backscattering level at the beginning of the fiber and the RMS (SNR = 1) noise level, after 3 minutes averaging and high dynamic resolution, using the largest pulse width.

- c. EDZ measured at ± 1.5 dB below the peak of a unsaturated reflective event using the shortest pulse width.
- d. ADZ measured at ± 0.5 dB from the linear regression, using a FC/UPC- type reflectance, at shortest pulse width.
- e. At 1650 nm
- f. At 1550 nm

Options and accessories

This chapter shows the part numbers of the SmartOTDR equipments and of the available options.

The topics discussed in this chapter are as follows:

- [“Ordering Information” on page 106](#)

Ordering Information

SmartOTDR Description ^a	Part Number
SmartOTDR 1550nm AS Range Handheld Tester With Continuous Light Source & PC/APC Connector	E100AS-PC/-APC
SmartOTDR 1550nm A-Range Handheld Tester with Continuous Light Source & APC Connector	E100A-APC
SmartOTDR filtered 1650 nm A-Range Handheld Tester with APC connector	E118FA65-APC
SmartOTDR filtered 1650 nm A-Range Handheld Tester with PON-XGPON (1490/1550/1578 nm) Power meter and APC connector	E118FA65PPM-APC
SmartOTDR 1310/1550nm A-Range Handheld Tester with Continuous Light Source & PC connector	E126A-PC
SmartOTDR 1310/1550nm A-Range Handheld Tester with Continuous Light Source & APC connector	E126A-APC
SmartOTDR 1310/1550nm & Filtered 1650nm B-Range Handheld Tester with Continuous Light Source & APC connector	E138FB65-APC
SmartOTDR 1310/1550nm & Filtered 1625nm B-Range Handheld Tester with Continuous Light Source & APC connector	E136FB-APC
SmartOTDR 1310/1550nm & Filtered 1650nm A-Range Handheld Tester with PC or APC connector	E138FA65-PC/-APC

a. For ordering in the USA replace E for F in the part number, e.g. E100AS-PC becomes F100AS-PC.

SmartOTDR Mainframe option	Part Number
Calibration Report	E100TDRCR

Battery and Power Supply	Part Number
Lithium Polymer battery for SmartOTDR (tray + batteries) (see "Replacing the battery" on page 129)	E10LIPO
AC/DC Power Supply	E20PWMC

Power Meter / VFL options	Part Number
Built-in VFL option with UPP 2,5 & 1,25 mm connectors for SmartOTDR	E10VFL
Optical power meter option for SmartOTDR (same port as OTDR)	E10PM
MP-60A;USB Optical power meter with accessories	MP-60A
MP-80A;USB Optical power meter high power with accessories	MP-80A

WiFi / Bluetooth options	Part Number
Built-in WiFi/Bluetooth Option for SmartOTDR	E10WIFIBLUE
External USB Wifi/Bluetooth dongle	EWIFIBLUE



NOTE

For other accessories, spare parts and software options, refer to the SmartOTDR datasheet.

Maintenance and Troubleshooting

This chapter describes how to maintain your unit and identify and correct problems related to the SmartOTDR.

The topics discussed in this chapter are as follows:

- [“Maintenance procedure” on page 110](#)
- [“Recycling Information” on page 125](#)
- [“Troubleshooting” on page 126](#)
- [“General information on warranty” on page 132](#)

Maintenance procedure

Maintenance work on this instrument must only be undertaken by qualified personnel using suitable equipment.

In most cases, it is advisable to contact the nearest VIAVI Service Centre, which will undertake the appropriate troubleshooting and repair work.

The performance and technical complexity of the SmartOTDR class this instrument in a new generation of equipment, for which VIAVI has laid down a maintenance policy based on the principle of standard module replacement.

In implementation of this policy, we have set up powerful card troubleshooting test resources in our factories and a rapid dispatch system operating between our factories and branches.

Only by this procedure can the high quality of the instrument continue to be ensured after repair work. This procedure also has the advantage of reducing repair costs and time.

In the interests of quality and efficiency, we strongly recommend adoption of the following procedure in the event of a fault, before any other steps are taken:

- Verify that the instrument is plugged in.
- Check the connections of any peripheral equipment to the Platform.
- If a fault is detected, or in case of doubt, it is advisable to contact the nearest VIAVI Service Centre, which will undertake the appropriate repair work.

Cleaning

Cleaning plates and housings

The front and rear plates and the housings may become tarnished with handling. To clean them, use only a rag moistened with soapy water.

Never use any product containing acetone, trichlorethylene, benzine or alcohol, as these will attack the printed markings.

Cleaning the screen

To clean the screen, use an antistatic product.

Cleaning the optical cable connector

- Use a non-fluffy type of paper, such as Joseph paper, soaked in isopropyl alcohol.
- Pay particular attention to the polished face of the fiber, rubbing it in a direction perpendicular to the axis of the fiber.

Cleaning the optical connections of the SmartOTDR

- Squirt a highly volatile solvent (such as isopropyl alcohol) into the connector.
- Blow out the connector using a clean dry air supply from an aerosol can fitted with an extension.



NOTE

If your equipment has a universal connector, unscrew its adaptor to access the ferule.

Accessing to the SmartOTDR information

On the SmartOTDR, some screens allow to display information on different elements of the equipment.

To display the information on the SmartOTDR

- 1 On the **Home** page, validate **Settings** icon to reach the **System Settings** page.
- 2 On the right menu keys, press **About** to display the presentation screen of the SmartOTDR.

General page

The **General** page is displayed by default, and allows to display the presentation screen, with all the information concerning the software versions, the hardware options and the OTDR module.

Figure 72 General page

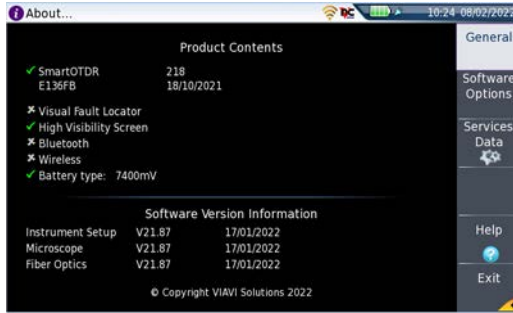

This page shows:

- The software version information
 - The product contents: base, optical options, battery type, touchscreen used, module type and date of calibration for options.
- The options set into the SmartOTDR are marked with a green tick.

Software options page

This page allows to visualize the software options available on the SmartOTDR.

- 1 Once on the **About** screen, press **Software Options** menu key to display the list of software options available on your SmartOTDR.

Figure 73 Software Options page

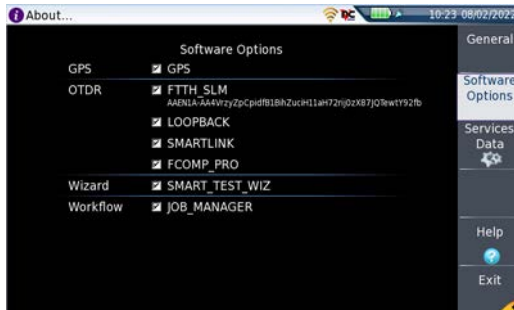

Services Data page

This page allows to display information about the elements inside the SmartOTDR (CPU, Memory, hardware revision, screen reference...).

- 1 Once on the **About** screen, press **Services Data** menu key to display the list of elements contained on your SmartOTDR.

Figure 74 Services Data page

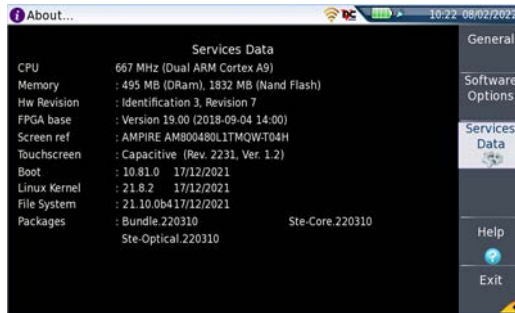

Accessing to the Platform documentation

All necessary documents for the Platform use are available from a QR Code onto the help page of the equipment.

- 1 Press **Help** key  from the About, Software Options or Service Data page.
- 2 In the pdf page, scan the QR Code to access the online documentation for the equipment : User manual, Getting Started Manual, Quick Card....

Figure 75 Help page



Installing a new version of the software



When a new software version is loaded, there is a risk of re-initialization of the internal memory. Before installing the new software, it is therefore advisable to save the results in the memory.



Do not interrupt the installation process, as this could damage the instrument.

To avoid any interruption of the installation procedure, the SmartOTDR must be operating on the mains: if the procedure is started while operating on battery, a message indicates that the instrument must be connected to the mains.

Downloading from Internet

When the software is obtained from the Internet, it must be saved on a storage medium before the software upgrade of the product can be carried out. To do this:

- 1 Open an Internet browser.
- 2 Enter the internet address <http://www.updatemyunit.net>, which will give access to the installation/update portals for all VIAVI products.
- 3 Click on the link [SmartOTDR® Platform](#).

A new page opens, displaying the current version available

- 4 According to your region, click on the one of the following icon to download the archive.



Download from European server



Download from North American server



Download from Singapore server

- 5 In the new dialog box displayed, click on **Save** to save the exe file on the PC.
- 6 Once completed, connect the USB memory stick to the PC and follow the instructions chapter "[Installation from a USB memory stick](#)" on page 116, from [step 2](#).

Installation from VIAVI Server

The update can be performed directly onto the equipment, using the VIAVI server.

- 1 Connect the SmartOTDR to a PC via an Ethernet cable or via WIFI.



- 2 Check on the **WIFI** setup page that the connection mode is defined to Automatic (**Home > Connectivity > /WIFI> Mode: Dynamic**).
- 3 On the **Home** page, press **Connectivity** icon .
- 4 Press **Upgrade** icon .
- 5 In the **Upgrade Server** box:
 - On the line **Address Type**, select **Viavi Server**
The address **smartotdr.updatemyunit.net** is automatically displayed.
- 6 Select if the new release for SmartOTDR must be automatically detected (**Enable**) or not (**Disable**). See [“Checking new upgrade on VIAVI Server” on page 118](#).

Figure 76 Configuration of the VIAVI Server



- 7 Press **Software Upgrade > Check available version**.
The message **Verify IP address of PC server** appears.
- 8 Touch **Continue**.
The list of the software versions available on the PC is displayed next to the versions installed on the SmartOTDR.

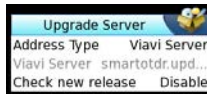
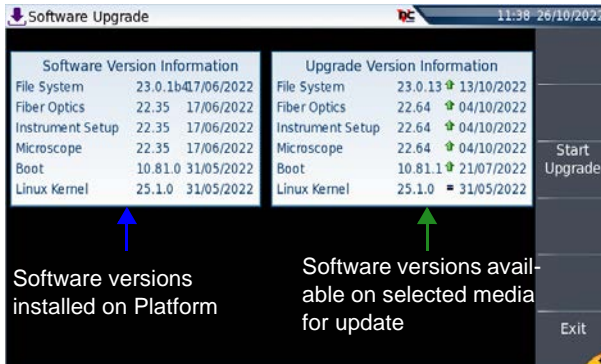

Figure 77 List of software versions (current and new)



Installation from another server

Before starting the software upgrade via Ethernet, make sure the IP address of the PC server.

The update can be performed directly onto the equipment, using an http address.

- 1 Connect the SmartOTDR to a PC via an Ethernet link or via WIFI.
- 2 Check on the **Ethernet** or **WIFI** setup page that the connection mode is defined to Automatic (**Home > Connectivity > Ethernet / WIFI > Mode: Dynamic**).
- 3 On the **Home** page, press **Connectivity** icon .
- 4 Press **Upgrade** icon .
- 5 In the **Upgrade Server** box:
 - On the line **Address Type**, select **Server Name** or **IP Address**.
 - Enter the Server Name (if **Server Name** has been previously selected) or the Server Address (if **IP Address** has been previously selected)
- 6 Select if the new release for SmartOTDR must be automatically detected (**Enable**) or not (**Disable**). See “[Checking new upgrade on VIAVI Server](#)” on page 118.
- 7 Press **Software Upgrade > Check available version**.
The message *Verify IP address of PC server* appears.
- 8 Touch **Continue**.
The list of the software versions available on the PC is displayed next to the versions installed on the SmartOTDR (see [Figure 77 on page 115](#)).

Installation from a USB memory stick

You must be equipped with a USB memory stick with a minimum capacity of 128 Mo.

Before installing the upgrade, you must format the USB memory stick (see “[Formatting the USB memory stick onto the SmartOTDR](#)” on page 127).

- 1 Once formatted, disconnect the USB memory stick from the SmartOTDR using the key **Eject USB** available pressing **Settings > Expert Tools > Media Utilities**.



As for any media formatting, please note that all data present on the USB memory stick will be irremediably lost.

- 2 Connect the USB memory stick to the PC
- 3 Unzip the upgrade files on the PC and transfer it to the USB memory stick:
 - a Download and save on your PC the.exe upgrade file that you can get from the web (<http://updatemyunit.net> see “[Downloading from Internet](#)” on page 114).
 - b Once the transfer is completed, double click on the.exe file: A window will appear. Check that the folder is correct i.e. the USB memory stick driver is appearing in the line at the bottom of the dialog box then press OK. If not, click on the icon  in order to select the right USB drive.

Figure 78 List of software update



- c Press **OK** and wait for the end of loading.
- 4 Then remove the USB memory stick, using the appropriate procedure, from your PC
- 5 Insert the memory stick into one of the USB ports on the product.

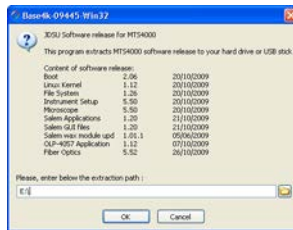

NOTE

A bip is emitted each time the USB memory stick is inserted or removed from the USB port.

- 6 On the Home page, press **Connectivity** icon .
- 7 Press **Upgrade** icon .
- 8 Press **Software Upgrade > Upgrade from USB**.
The message Are you sure? is displayed
- 9 Touch **Confirm**.
The list of the software versions available on the USB stick is displayed next to the versions installed on the SmartOTDR (see [Figure 77 on page 115](#)).

Launching the upgrade

Whatever is the method selected for upgrade (Server, USB key...) and once the list of the software versions available is displayed next to the versions installed on the SmartOTDR (see [Figure 77 on page 115](#)), follow these instructions to launch the upgrade:

- 1 Touch **Show Prev choice** or **Show Next Choice** to display the previous and next versions available.
- 2 Touch **Start Upgrade** to start the upgrade of the selected software(s).



NOTE

The software versions list does not always appear (cf previous versions) as well as the **Previous / Next Choice** buttons.

Upgrading begins. The SmartOTDR is automatically rebooted. Upgrading takes several minutes. Finally, the SmartOTDR is automatically restarted.



During the upgrade, the Testing indicator is lit in red. Do not push any button or remove the USB memory stick while the indicator is lit. The USB stick can be removed if necessary once the Testing indicator is off.

Checking new upgrade on VIAVI Server

If the VIAVI Server is selected for upgrade (see [Figure 76 on page 115](#)), the parameter **Check new release** can be defined to automatically inform user of a new upgrade available for Platform.

- 1 In the **Connectivity** screen, press **Upgrade** icon.
- 2 Check the **Address Type** is set to **Viavi Server**.
- 3 Define the parameter **Check new release** to **Enable**.

If the parameter is set to **Enable**, a message displays, at any time, when one update is available on server.

Figure 79 Checking new release

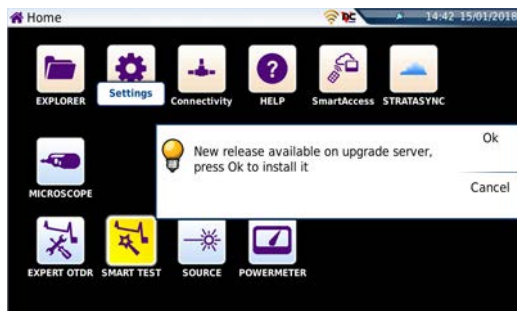

- 4 Press **Ok** to display the list of software versions available (see [Figure 77 on page 115](#)) and follow instructions “[Launching the upgrade](#)” on [page 118](#).

Upgrading from the boot

This method is used to make a complete reinstallation of the software versions.



This operation should not be processed without VIAVI Technical Assistance Center formal approval.

- 1 Turn off the SmartOTDR using the **ON/OFF** button, keeping the equipment connected to the mains.
- 2 Insert the USB stick onto which the software versions are stored into one of the USB port of the Platform
- 3 Press simultaneously **SETUP + START/STOP** buttons
- 4 Maintaining the two buttons pressed, press **ON** button to start the SmartOTDR.
- 5 A menu displays, then the screen allows to select **Upgrade from USB**
After a few seconds, a new page displays indicating that to continue the reboot, the validation key must be pressed.
Press the hard key .
The reboot starts automatically.



The Testing indicator will be lit in red during upgrade. Do not push any key or remove the USB memory stick until the lit turns off.

Once the upgrade is completed, the SmartOTDR will automatically turns on and display the Home page.

Install Software License

This page allows to import the license to get a software option.

Figure 80 Example of a License file (.lic)

```
# JDSU Software Option license file for MTS1000 PLATFORM
#
# This license file contains your licenses.
#
# Lines starting with #, blank lines, small header lines, and any
# other lines not starting with a JDSU keyword are comments that
# licenses reader ignores.
#
# Except as noted, please do not modify lines starting with
# keywords.
#
#-----
# This file should be loaded onto your MTS1000 product in order
# to activate your software options.
#-----
#
# To do so,
# First copy this file onto a USB stick.
# Then, starting from the Home screen (press "Home" to go to this
# screen):
#
# Press the following keys:
#   Expert Tools
#         -> Upgrades
#               -> Install Option
#                       -> Import License
#
# You should then select this file from the File Explorer window
# and press "Load".
# followed by "Confirm".
#
# The challenge codes contained in this file will then be loaded
# automatically and your
# software options will be installed.
#
# At the end of this sequence you will be asked to reboot the
# unit.
#
# You may also enter these challenge codes manually, if you wish.
#
#-----
# Demo License expiry class = 30 days
# Demo License expiry date = 2019-03-09
#
#-----
# Validation date : 0000-00-00 00:00:00
# Generation date : April 9, 2019, 10:47:32
# Challenges Codes
#   lic_id=9991 ( AAA10w )   fct=FTTH-SLM (OTDR PON + Smart Link
# Mapper + OFI)MULES3   lic file Path =SMARTOTDR_base_mn=03 CID=
# 0000 Expiry=2485
# MTS1000LIC AAA10w:
AA4VryzpcidR1mhZuc1M1aR7z1g0KyColL79e42c1b
```

Licence Code

To import the license, you can either enter manually the license code, given in the license file, (.lic file) or import this file with a USB memory stick connected to the SmartOTDR.



It is strongly recommended to perform the installation using the importation of License via a USB memory stick.

Install options from VIAVI Server

- 1 In the **Home** page, touch **ADD OPTIONS** icon.
- 2 Touch **Install From Server** softkey.

Fig. 81 Install options from VIAVI Server

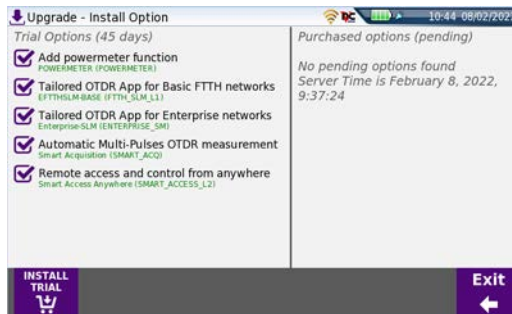

- 3 On the left part of the screen, select or deselect the options to be installed or not for 30 days trial.
- 4 In the right part, are displayed the purchased license(s) and that can be installed onto the Platform.
- 5 Touch **INSTALL TRIAL** to start the installation of the selected options.
- 6 Touch **INSTALL PURCHASED** to start the installation of the license(s) which have been purchased to VIAVI.

To display the list of installed options, from the **Home** page, touch **Settings** icon and press **About > Software Options** softkeys (see [Figure 73 on page 112](#)).

Enter Manually the License

- 1 In the **Home** page, touch **ADD OPTIONS** icon.
- 2 Touch **Enter Challenge**

- The edition keypad is displayed
- 3 Enter the challenge code of the option, set at the bottom of the file (see [Figure 80 on page 120](#)),

Figure 82 Enter the License code

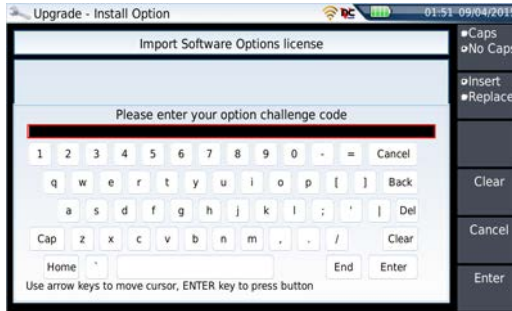

The license file can be opened via a word processing software such as Word...

The challenge code must be entered exactly as it is in the .lic file, paying attention to the lower-case and upper-case letters etc.

- 4 Press the **Enter** key to validate the code.
Your software options will be installed.
At the end of this sequence you will be asked to reboot the unit to apply the modifications, pushing the key . Confirm the reboot to restart the Platform.

Import the license from the USB memory stick



CAUTION

Any file linked to the license file (.lic) must be saved at the root of the USB key.

- 1 In the **Home** page, touch **ADD OPTIONS** icon.
- 2 Touch **Import File**.

If the USB memory stick is not already connected to the Platform, a message asking the memory stick insertion is displayed. **Confirm** it once the stick is connected.

- 3 In the File Explorer, select the USB stick, then the license file (.lic) to be imported,
- 4 Touch **Load** > **Confirm**
The challenge codes contained in this file will then be loaded automatically and your software options will be installed.

Figure 83 License imported



- 5 At the end of this sequence you will be asked to reboot the unit to apply the modifications, pushing the key .
- 6 Confirm the reboot

Locking the SmartOTDR

The SmartOTDR can be locked at any time:

- 1 In the **HOME** page, select the **Settings** icon .
- 2 In the **System Settings** page, touch **Expert Tools** > **Instrument Lock**.
- 3 Confirm the SmartOTDR locking by pressing **Confirm** (or use the **Cancel** key to cancel the process).
The numeric keypad is displayed
- 4 Enter the password to lock the instrument: 42000 with the numeric keypad displayed.

Figure 84 Password



- 5 Touch **Enter**
The SmartOTDR locking screen is displayed.

Figure 85 Locking screen



Touch the **Notepad Message** key to add a message using the text edition.

Unlocking the SmartOTDR

- 1 Once the locking screen is displayed, click on the key **Unlock Instrument**.
- 2 Press **Confirm** to confirm the Platform must be unlocked.
- 3 Enter the password **42000** using the numeric keypad displayed and validate.
The screen automatically displays the **HOME** page.

Sending equipment to VIAVI for calibration, maintenance, or repair

VIAVI Solutions is a single-source supplier for all of your factory and on-site test equipment repair, warranty, maintenance, and calibration service needs.

Please complete the on-line RMA form to obtain authorization prior to shipping your instrument to VIAVI for repair or calibration. Do not ship the equipment until you receive the Return Authorization (RA) number from VIAVI. You may use this number to track your equipment during repair, calibration, or upgrade.

Guarantee conditions

Any repair operation supervening within the guarantee period of the instrument will be carried out at the expense of Viavi. However, for any sub-assembly upon which work has been carried out otherwise than by VIAVI Service Centers, the cost of a replacement sub-assembly will be invoiced.

Recycling Information

VIAVI recommends that customers dispose of their instruments and peripherals in an environmentally sound manner. Potential methods include reuse of parts or whole products and recycling of products components, and/or materials.



Waste Electrical and electronic Equipment (WEEE) Directive

In the European Union, this label indicates that this product should not be disposed of with household waste. It should be deposited at an appropriate facility to enable recovery and recycling.

Troubleshooting

Interpreting alarms

Troubleshooting	Solution
Nothing happens when the ON/OFF key is pressed.	- Make sure that the battery is present or charged; or the mains adapter is properly connected (see “Connecting the mains adapter” on page 13).
Nothing happens on screen, whatever is the action done (menu key / hard key pressed...)	- The Platform must be rebooted. See “Built-in kickstand” on page 16 .
Nothing happens on touchscreen, whatever is key pressed (icon, menu key...)	- Perform an Autotune. See “Touchscreen calibration («Autotune» process for capacitive touchscreen)” on page 128 .
You are using the SmartOTDR in the ordinary way when it suddenly switches off.	- Check the instrument is not configured to Auto off. See “Defining the Automatic shutdown and the storage limit” on page 22 . - Check the battery charge level. See “Charging the battery” on page 13 .
The battery refuses to charge (the Charge indicator does not go on when the instrument is connected to the mains and is not operating).	- There is no battery in the instrument. - The temperature level of the equipment does not allow the battery charging for safety reasons. Wait the equipment cools down. - The battery needs to be changed. See “Replacing the battery” on page 129 .
Error message when USB has been disconnected	- The USB disconnection has not been done properly (see “USB memory stick disconnection” on page 92) - The data transfer was not completed when USB key was disconnected.
No beep is emitted when the USB memory stick is connected	- A previous USB memory stick has not been properly disconnected (see “USB memory stick disconnection” on page 92). - The USB memory stick is not detected by the SmartOTDR: use another memory stick, or another storage media.

Troubleshooting	Solution
Error message when upgrade via Ethernet is confirmed	- Check the Server Name is correctly entered (see “Installation from another server” on page 116)
Error message when upgrade via USB key is confirmed	Check the USB key is correctly connected (see “USB memory stick connection” on page 92)
Error message when unlocking the instrument	- The password is not the correct one (see “Locking the SmartOTDR” on page 123).

Formatting the USB memory stick onto the SmartOTDR

If the USB icon  is displayed on the upper banner of the screen, when a USB memory stick is connected to the SmartOTDR, this may mean the memory stick must be formatted.

If the stick needs to be formatted, proceed as follows:

- 1 Insert the memory stick into one of the USB port on the top of the SmartOTDR.
- 2 Press the **HOME** button
- 3 Validate the **Settings** icon to open the **System Settings** page.
- 4 On the right menu keys, successively select **Expert tools > Media utilities > Usbflash Format**.
- 5 Confirm your choice to actually format the USB memory stick.



As for any media formatting, please note that all data present on the USB memory stick will be irremediably lost.

Erase disk

To delete all the disk contents of the SmartOTDR:

- 1 On the Home page, press the **Settings** icon to open the **System Settings** page
- 2 Press **Expert Tools > Media Utilities**,
- 3 Select **Disk Erase** to delete all the disk contents into the SmartOTDR.
A confirmation must be validated before the deletion.
- 4 Enter the password 02468753 and press **Enter** to start disk erasing.

Touchscreen calibration («Autotune» process for capacitive touchscreen)

In case of problem with the capacitive touchscreen of your SmartOTDR, an «Autotune» can be performed:

From the **Home** page:

- 1 Press **Settings** icon top open the **System Settings** screen
or

If the use of the touchscreen is not possible, press simultaneously the up and down arrow keys on the Platform to open the **System Settings** screen.

- 2 Press again the up and down arrow keys simultaneously.
A dialog box displays, asking if you wish to perform an Autotune.



Figure 86 Autotune process



- 3 Press **Confirm** to start Autotune process.
A dialog box displays during the process.

 Autotune in progress. Please don't touch the product



NOTE

Do not touch the product during the Autotune process!

Once the dialog box is closed, the Autotune process is completed, and the screen is calibrated.

Replacing the battery



CAUTION

Battery is not interchangeable in the field. It must be replaced exclusively for maintenance purpose.

Accessing to the battery

To access the battery of the SmartOTDR, proceed as follows:

- 1 Switch off the instrument and disconnect the mains supply.
- 2 Turn the instrument face down on a flat surface.
- 3 Remove the battery door
- 4 Gently pull on the battery's connector and disconnect it from its socket.

Figure 87 Battery location

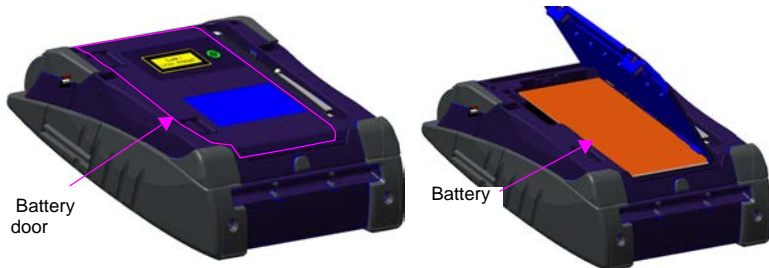

Date and Time parameters will be lost when battery is disconnected.

Installing a new battery

- 1 Connect the battery's connector to the socket.
- 2 Set the battery into its seating.

Figure 88 Setting a new battery

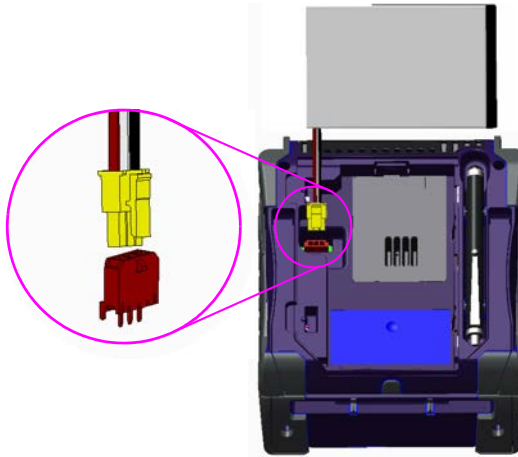

- 3 Close the battery door
The instrument can be turned on.



NOTE

Take care to set the connector of the battery in the right way on the plug of the base!
Do not forget the black foam to wedge the battery.



When putting a battery back into its seating, make sure that its connector engages correctly in the socket and that the door is correctly closed.

Contact VIAVI local Sales Service to get a new battery.



Do not use any battery other than the one supplied with the instrument, or supplied by VIAVI.

Installing the Bluetooth/WIFI option

The Bluetooth and WIFI interfaces allow interface and file transfers.



BLUETOOTH OPTION

The product is approved in accordance to R&TTE directive concerning transmitter module marked by CE0678. It is manufactured by MITSUMI and it is an OEM product.

This device complies with Part 15 of the FCC Rules. Operation is subject to the following two conditions: (1) this device may not cause harmful interference, and (2) this device must accept any interference received, including interference that may cause undesired operation. This device contains FCC-ID: POOWML-C40.

The Bluetooth/WIFI option consists of a USB dongle and a printed circuit board (PCB) to be connected to the bottom part of the SmartOTDR.

To install the Bluetooth/WIFI option onto the SmartOTDR:

- 1 Switch off the SmartOTDR and unplug it from mains.
- 2 Remove the cover on the underside of the Platform, unscrewing the two screws. If the board is already set into the Platform, follow instructions on [step 4](#).
- 3 Insert the board, pressing it gently but firmly, taking care to the connectors.

Figure 89 View board and connectors



- 4 Insert the Bluetooth/WIFI USB dongle into the connector of the board.

Figure 90 Bluetooth set into the Platform



- 5 Screw back the cover onto the Platform.
The Bluetooth/WIFI option can be launched.

General information on warranty

The warranties described herein shall apply to all commercially available VIAVI products. Any additional or different warranties shall apply only if agreed to by VIAVI in writing. These warranties are not transferable without the express written consent of VIAVI.

Hardware Warranty

VIAVI warrants that Hardware Product sold to customer shall, under normal use and service, be free from defects in materials and workmanship. Information regarding the specific warranty period for this product can be obtained by contacting your local VIAVI Customer Service Representative, or at our web site www.viavisolutions.com. If installation services have been ordered, the warranty period shall begin on the earlier of (1) completion of installation, or (2) thirty (30) days after shipment to customer. If Installation Services have not been ordered, the warranty period shall begin upon shipment to Customer. Hereafter these periods of time shall be collectively referred to as the Initial Warranty Period.

VIAVI's obligation and customer's sole remedy under this Hardware Warranty is limited to the repair or replacement, at Acterna's option, of the defective product. VIAVI shall have no obligation to remedy any such defect if it can be shown: (a) that the Product was altered, repaired, or reworked by any party other than VIAVI without VIAVI's written consent; (b) that such defects were the result of customer's improper storage, mishandling, abuse, or misuse of Product; (c) that such defects were the result of customer's use of Product in conjunction with equipment electronically or mechanically incompatible

or of an inferior quality; or (d) that the defect was the result of damage by fire, explosion, power failure, or any act of nature.

VIAVI performed repairs shall be warranted from defective material and workmanship for a period of ninety (90) days, or until the end of the Initial Warranty Period, whichever is longer. Risk of loss or damage to Product returned to VIAVI for repair or replacement shall be borne by customer until delivery to VIAVI.

Upon delivery of such product, Viavi shall assume the risk of loss or damage until that time that the product being repaired or replaced is returned and delivered to customer. Customer shall pay all transportation costs for equipment or software shipped to VIAVI for repair or replacement. VIAVI shall pay all transportation costs associated with returning repaired or replaced product to customer.

Warranty disclaimer

For hardware and/or services furnished by VIAVI, the foregoing warranties are in lieu of all other warranties and conditions, express or implied. VIAVI specifically disclaims all other warranties, either express or implied, on any hardware, documentation or services including but not limited to warranties relating to quality, performance, noninfringement, merchantability or fitness for a particular purpose, as well as those arising from any course of dealing, usage or trade practice.

Under no circumstances will VIAVI be liable for any indirect or consequential damages related to breach of this warranty.

Index

A

- About page [111](#)
- Accessories [105](#)
- Adapter
 - specifications [97](#)
- Attenuation
 - Specifications [102](#)

B

- Battery
 - charging time [96](#)
 - specifications [96](#)
- Bluetooth
 - pairing [47](#)
 - remove pairing [49](#)
 - search devices [48](#)
 - specifications [101](#)

C

- Cleaning
 - plates, housings and screen [110](#)
- Connectors
 - cleaning [111](#)
- CSV file [88](#)
- Cursor
 - Resolution [102](#)

D

- Distance
 - Specif. OTDR measurement [101](#)

F

- File
 - storage media [91](#)
- File Transfer
 - Bluetooth [73](#)
 - WIFI [74](#)

G

- Guarantee conditions [125](#)

I

- Indicators [8](#)
- IOR
 - Specifications [102](#)

L

- License
 - enter manually [122](#)
 - import from USB [122](#)
- License file [88, 120](#)

M

- Measurement
 - Distance (specif.) [101](#)
 - Reflectance (specif.) [102](#)
 - Memory
 - capacity [96](#)
 - MSOR file [88](#)
-

O

- Optical connectors
 - precautions [3](#)
 - OTDR
 - Specif. measurement [101](#)
 - OTDR file [88](#)
-

P

- PDF File [88](#)
 - Platform
 - indicators [8](#)
 - locking [123](#)
 - reset [16](#)
 - switching off [15](#)
 - switching on [15](#)
 - troubleshooting [126](#)
 - Power meter
 - connection [24](#)
 - Power Meter file [88](#)
-

R

- Reflectance
 - Specifications [102](#)
-

S

- Screen
 - specifications [96](#)
 - Screenshot [89](#)
 - Services data [113](#)
 - Software update
 - via Internet [114](#)
 - via USB [116](#)
 - Storage media [91](#)
 - abbreviations [93](#)
-

T

- Text file [88](#)
 - Transfer interface
 - ethernet Mode [55](#)
 - proxy config. [56](#)
 - remote screen [54](#)
-

U

- USB
 - connection [92](#)
 - disconnection [92](#)
 - upgrade via [116](#)
-

V

- VFL
 - connection [24](#)
 - specifications [100](#)
-

W

- WIFI
 - configuration [52](#)
-



**7SMART102
Rev 006, 02-23
English**

Viavi Solutions

North America:	1.844.GO VIAVI / 1.844.468.4284
Latin America	+52 55 5543 6644
EMEA	+49 7121 862273
APAC	+1 512 201 6534
All Other Regions:	viavisolutions.com/contacts
email	TAC@viavisolutions.com