



Phocos Any-Grid™ series

Pure Sine Wave Hybrid Inverter Charger with
MPPT Solar Charge Controller

PSW-H-8kW-230/48V

PSW-H-5kW-230/48V

PSW-H-3kW-230/24V

PSW-H-6.5kW-120/48V

PSW-H-5kW-120/48V

PSW-H-3kW-120/24V

User and Installation Manual



English

For further languages see
Für weitere Sprachen siehe
Pour autres langues voir
Para otros idiomas ver
对于其他语言请参阅

www.phocos.com

Contents

1.0	Introduction	2
2.0	Important Safety Information	2
3.0	Regulatory Information	3
4.0	Overview	4
4.1	Functional Overview	4
4.2	Product Overview	5
5.0	Installation	6
5.1	Package Contents	6
5.2	Installation of Battery Wiring Extension Box and Cable Glands	6
5.3	Mounting the Unit	7
5.4	Battery Connection	8
5.5	AC Input and AC Output Connection	9
5.6	PV Connection	11
5.7	Final Assembly	13
5.8	Remote Display Panel Installation	13
5.9	Installing Multiple Units in Parallel, Split Phase or 3-Phase Configuration	15
6.0	BLE Communication	21
7.0	Relay Contact	21
8.0	Operation	22
8.1	Inverter Power ON/OFF	22
8.2	Display and Control Module	22
8.3	Display Symbols	23
8.4	Device Operation Settings	25
8.5	USB and Timer Settings	34
8.6	Screen Views of Current Values	36
8.7	Operating Mode Description	43
9.0	Fault Reference Codes	46
10.0	Warning Codes	47
11.0	Troubleshooting	49
12.0	Specifications	52
12.1	Grid Mode	52
12.2	Off-Grid Mode	53
12.3	Battery Charging	55
12.4	General	56
13.0	Warranty	57
13.1	Conditions	57
13.2	Liability Exclusion	57

1.0 Introduction

Dear customer, thank you for choosing this quality Phocos product. The Any-Grid™ pure sine wave hybrid inverter / charger series has numerous outstanding features and use-cases such as:

- Function as purely Off-Grid inverter for applications with no AC power source
- Function as solar enabled (optional) uninterruptible power supply (UPS) functionality for intermittent or unstable AC sources
- Function as grid-connected or AC-generator-connected inverter to reduce energy demand from the AC source by prioritizing solar and/or battery power, thus saving energy costs
- Grid injection of excess energy possible where it is legal, with or without a connected battery. Accidental injection is prevented by requirement of a PIN code for activation
- Both neutral (N) and live (L) wires of the AC input are automatically disconnected (break-before-make relays) from the AC output when the Any-Grid operates in Off-Grid mode
- High-voltage MPPT solar charge controller allows the connection of more solar panels in series (compared to other Off-Grid solar charge controllers), typically eliminating the need for expensive combiner boxes
- Battery charging from an AC source such as the public power grid or a genset
- Compatibility with multiple battery types including lead-acid (gel, AGM and liquid electrolyte) and Lithium-based batteries such as LiFePO4
- Battery-free mode: if an AC source is available, photovoltaic (PV / solar) power can be used as first priority, even with no battery attached
- Removable wired display unit can be installed in a different room (up to 20 m / 66 ft cable can be used)
- All-in-one hybrid unit allows simple and fast installation, and easy configuration
- Monitor the unit in real-time with the PhocosLink Mobile BLE smartphone App
- Optional accessory: Phocos Any-Bridge™ AB-PLC Monitoring & Control Gateway (sold separately) to connect to the PhocosLink Cloud from anywhere with any internet-capable device via its web browser

This manual describes the assembly, installation, operation and troubleshooting of this unit.

2.0 Important Safety Information

SAVE THESE INSTRUCTIONS: This manual contains important instructions for models PSW-H-5kW-230/48V, PSW-H-8kW-230/48V, PSW-H-6.5kW-120/48V and PSW-H-5kW-120/48V (referred to as 48 Vdc models), as well as the PSW-H-3KW-230/24V and PSW-H-3kW-120/24V (referred to as 24 Vdc models) that shall be followed during installation and maintenance of the hybrid inverter/charger. The PSW-H-8kW-230/48V, PSW-H-5kW-230/48V and PSW-H-3KW-230/24V are also referred to as 230 Vac models, the PSW-H-6.5kW-120/48V, PSW-H-5kW-120/48V and PSW-H-3KW-120/24V as 120 Vac models. Read and save this manual for future reference.

WARNING: The installation of this unit may only be undertaken by qualified personnel with appropriate training. High voltages in and around the unit can cause serious injury or death. This unit must be installed in accordance with rules and regulations at the site of installation.

CAUTION: A battery can present a risk of electrical shock, burn from high short-circuit current, fire or explosion from vented gasses. Observe proper precautions.

WARNING: This unit must be connected to a permanent grounded wiring system. Be sure to comply with local requirements and regulations when installing this unit.

BATTERY TYPE: Suitable for use with lead-acid (gel, AGM and liquid electrolyte) and Lithium-based batteries such as LiFePO4.

OVERCURRENT PROTECTION FOR BATTERY: Install an overcurrent protection device with a minimum of 1000 A interrupt rating as close as possible to the battery terminal. Select a device rated for 1.25 times the nominal current rating of the inverter/charger. An overcurrent protection device must be purchased separately.

1. Before using the unit, read all instructions and cautionary markings on this unit, the batteries, the solar modules, any connected loads.

2. Please do not disassemble or attempt to repair Phocos products. This unit does not contain user serviceable parts. Damage to the warranty seal will lead to a loss of warranty of the product and can lead to injury.
3. To reduce risk of electric shock, disconnect all wirings before attempting any maintenance or cleaning. Switching off the unit is not sufficient, turn off and / or disconnect all connections to the unit.
4. For safe operation of this unit, please adhere to appropriate cable size requirements in this manual.
5. Be very cautious when working with uninsulated metal tools on or around batteries. They can short-circuit batteries or other electrical parts and could cause an explosion and / or injury.
6. Strictly follow the installation procedure when connecting or disconnecting AC or DC terminals. Please refer to the **"Installation"** section of this manual for details.
7. Appropriate fuses or breakers are required near the battery supply and AC input and AC output of this unit.
8. **WARNING:** It is highly recommended and legally required in many countries to install a Type B residual current device (RCD) between the AC output of the unit(s) and the AC loads to protect humans from hazardous electric shock due to faulty AC wiring, faulty loads or a potential inverter fault.
Only in Off-Grid mode, the neutral (N) and ground (PE) of the AC output are automatically bridged inside the Any-Grid to ensure the RCD's functioning if the AC installation is wired correctly as a TN-S or TN-C-S earthing system. In a TN-C-S installation the bridge between neutral (N) and ground (PE) must be between the public grid and AC input of the Any-Grid to ensure that there is never more than one bridge between N and PE.
9. Never allow any AC or DC connections to be short-circuited. Do not connect to the mains when the battery input is short-circuited.
10. Only qualified service persons may service this device. If errors persist after following the **"Troubleshooting"** section in this manual, please send this unit back to a local Phocos dealer or service center for maintenance.
11. **WARNING:** Because this inverter (AC output) is not isolated from the PV input, only solar panels are acceptable for use which do not require positive or negative grounding as grounding the positive or negative PV cables is not allowed. To avoid any malfunction, do not connect any PV modules with possible current leakage to the inverter. For example, positive- or negative-grounded PV modules will cause current leakage to the inverter. Grounding of the PV module frame is permitted and frequently required by local law.
The battery is galvanically isolated from the inverter and PV input, therefore the battery positive or negative terminal may be grounded if required.
12. **CAUTION:** When using more than one Any-Grid, ensure that each Any-Grid is connected only to its own PV array. There may be no electrical contact between units' PV arrays, or the Any-Grids will be damaged.
13. **CAUTION:** It is highly recommended to use a surge arrester, also named surge protective device (SPD) near the PV input terminals of this unit. This is to prevent damage to the unit from lightning, thunderstorms, or other voltage surges on the PV cables. The max. DC operating voltage of the SPD must be between 450 and 480 Vdc for 230Vac models (500 to 550Vdc for PSW-H-8KW-230/48V). For example, the *Citel DS240-350DC* or *Phoenix Contact VAL-SEC-T2-2+0-380DC-FM* is suitable (*Citel DDC50-21Y-500* for PSW-H-8KW-230/48V). For 120 Vac models the max. DC operating voltage must be between 250 to 280 Vdc, so for example the *Citel DS240-220DC* or *Phoenix Contact VAL-SEC-T2-2+0-220DC-FM* is suitable.
14. **CAUTION:** It is highly recommended to use a surge arrester, also named surge protective device (SPD) near the AC input terminals of this unit, if the AC input is used. This is to prevent damage to the unit from lightning, thunderstorms or other voltage surges on the AC input conductors (for example coming from the public grid). The max. AC operating voltage of the SPD must be between 275 and 300 Vac for 230 Vac models. For example, the *Citel DS415-230* or *Phoenix Contact VAL-MS230* (for most public grids or generators, higher protection) or *Citel DS415-320* (for public grids with large voltage swings, lower protection) are suitable.
For 120Vac models the SPD must have a max. AC operating voltage between 140 and 150 Vac. For example, the *Citel DS415-120* or *Phoenix Contact VAL-SEC-T2-1S-175-FM* is suitable.

3.0 Regulatory Information

This product is CE (applies to 230 Vac models) and RoHS (Restriction of Hazardous Substances) compliant. The PSW-H-6.5KW-120/48V model is UL1741 and CSA22.2 No. 107 and FCC Class A (applies to the display unit) compliant.

Please find the CE declaration and other certifications at www.phocos.com.



This product is manufactured in an ISO 9001 (quality management) and ISO 14001 (environmental management) certified facility.

This equipment is suitable for use in non-hazardous locations only.

This is a class A device: in a domestic environment this product may cause radio interference in which case the user may be required to take adequate measures.

4.0 Overview

4.1 Functional Overview

This pure sine wave hybrid inverter charger with solar charge controller (MPPT) can provide power to connected loads by utilizing PV power, AC power and battery power. Most connections are optional, but there must be at least one power source (AC or PV):

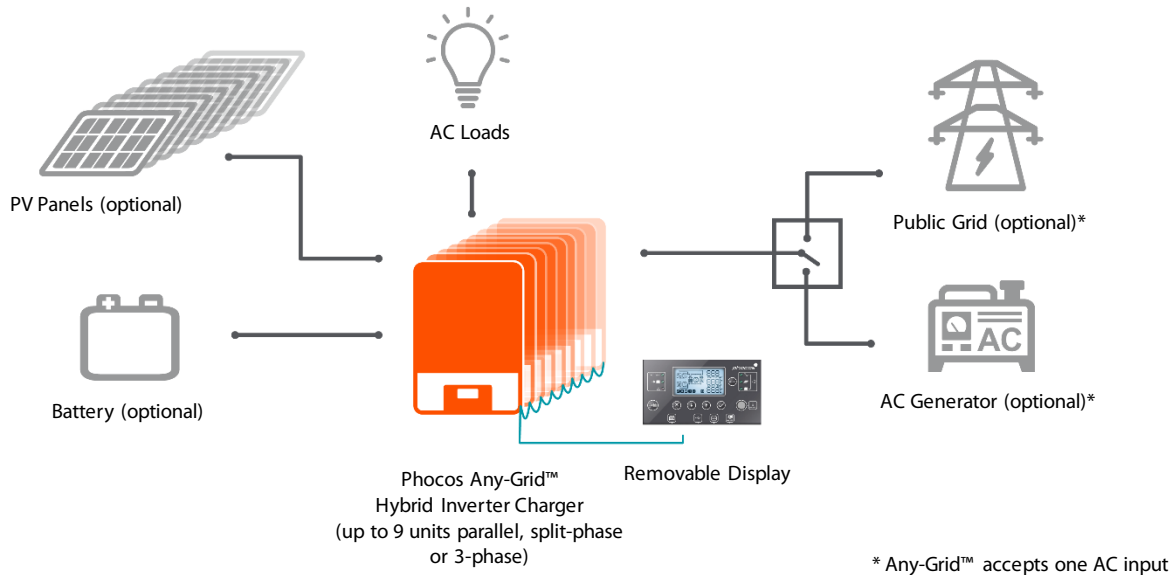

Fig. 1: System Overview

This unit has one each of the following power connections: battery, PV, AC input, AC output. The unit is designed to provide continuous power from PV / battery or an AC source, depending on the set priority. Independently, the priority for charging the battery can be set (the battery can only be charged from AC when the unit is not working in Off-Grid mode). The switching time between Grid (also valid when an AC generator is used) and Off-Grid modes is only 10 milliseconds (typical) when a single Any-Grid unit is used. Timers can be used to change the priorities based on hourly time slots; this is useful for areas where grid power has differing costs throughout the day. The integrated maximum power point tracking (MPPT) solar charge controller can handle particularly high PV voltages, allowing for a simpler installation and lower costs than most Off-Grid solar charge controllers. Typically, no combiner boxes or string fuses / diodes are required.

The pure sine wave AC output and the surge power capability (twice the continuous power rating) assure all types of AC loads can be powered. Ensure that the peak power requirement of the loads is below the surge power capability of this inverter.

Two special functions allow even more flexibility: Battery-Free mode and Grid Injection.

In Battery-Free mode, no battery is connected to the unit and an AC source must be present. The unit will then provide as much power from PV as is available to supply loads, adding any missing power from the AC source. If there is more PV power available than can be utilized by the loads, then the PV power is reduced to ensure no power feed-in into the grid.

The Grid Injection functionality allows feeding any excess power into the grid. If there is excess PV power beyond what is utilized by the load and for battery charging, this power can be fed into the public grid to take advantage of net metering or feed-in tariffs. In this way all the PV power can be used even if the battery is full, and the loads do not require all the available PV power. Feeding into the grid may be prohibited in some areas so this function is locked by a PIN code to avoid accidental grid injection.

4.2 Product Overview

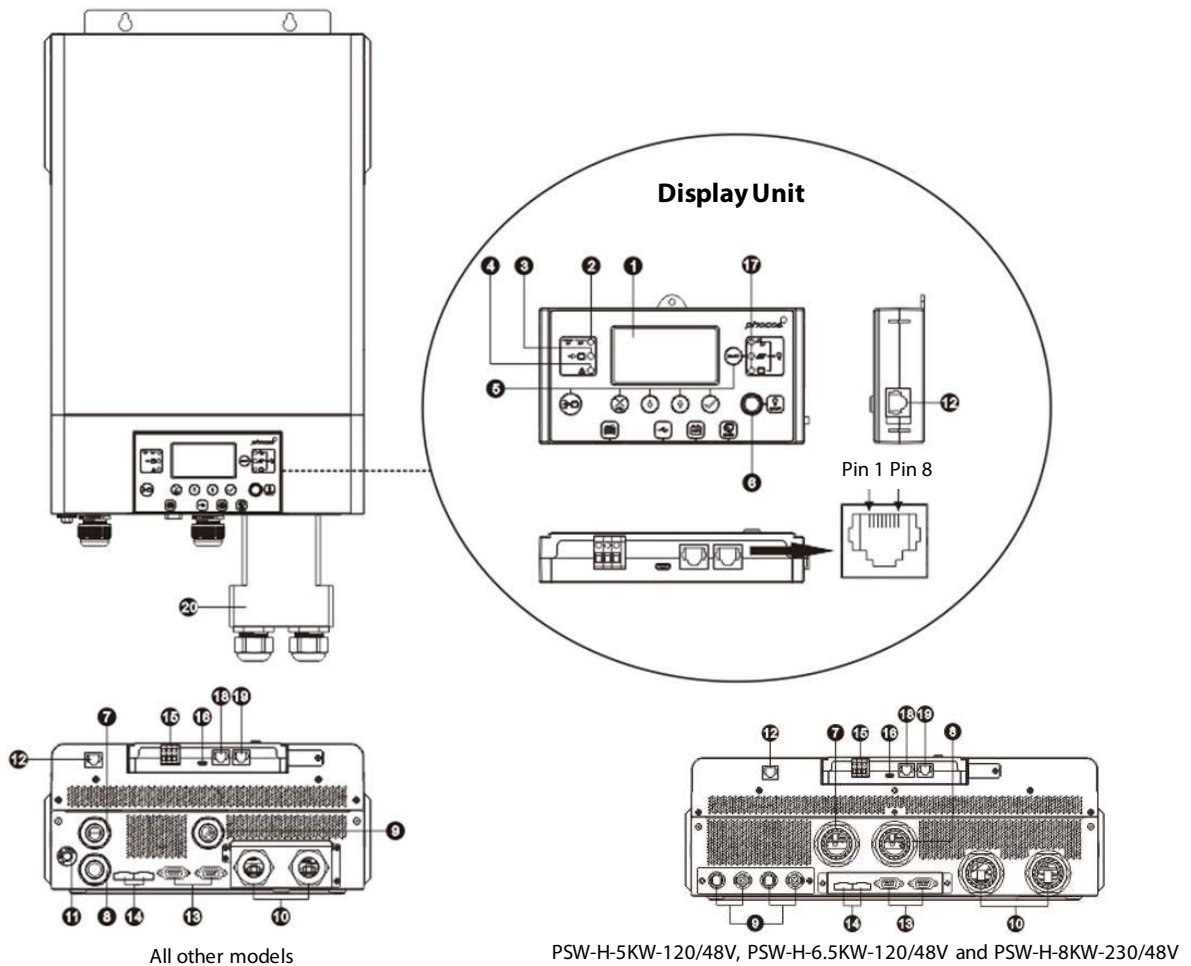

Fig. 2: Product Overview

1. LCD screen
2. Inverter status indicator
3. Charging indicator
4. Fault indicator
5. Function buttons
6. AC output on/off switch (solar charging still functions when the AC output is powered off)
7. AC input terminals (public grid or AC generator connection)
8. AC output terminals (load connection)
9. PV terminals
10. Battery terminals
11. Resettable circuit breaker
12. Remote display unit communication port
13. Parallel communication port (for inter-connecting multiple Any-Grid units)
14. Current sharing port (for inter-connecting multiple Any-Grid units)
15. Relay contact
16. USB-OTG communication port
17. Output source indicators and USB function indicators
18. Battery Management System (BMS) communication port: CAN, RS-485 and RS-232
19. RS-232 communication port
20. Battery wiring extension box (only included with PSW-H-3KW-120/24V and PSW-H-6.5KW-120/48V)

5.0 Installation

5.1 Package Contents

Before installation, please inspect the unit to ensure nothing inside the package is damaged. Package contents:

- Any-Grid unit
- This manual
- RS-232 cable (SUB-D to RJ-45)
- Parallel communication cable (gray connectors, needed for systems with multiple Any-Grid units)
- Current sharing cable (green connectors, needed for systems with multiple Any-Grid units on a phase)
- 3 pcs. ring terminals for battery connection (2 pcs. required for installation)
- 4 pcs. MC4 connectors for PV connection (PSW-H-5KW-120/48V, PSW-H-6.5KW-120/48V and PSW-H-8KW-230/48V)

5.2 Installation of Battery Wiring Extension Box and Cable Glands

Note: Cable glands applicable to 120 Vac models and PSW-H-8KW-230/48V only. Battery wiring extension box applicable to PSW-H-3KW-120/24V and PSW-H-6.5KW-120/48V only.

Installation of the battery wiring extension box is necessary for UL conformity. If UL conformity is not required in your region, it is sufficient to only install the cable glands (step 3) shown below.

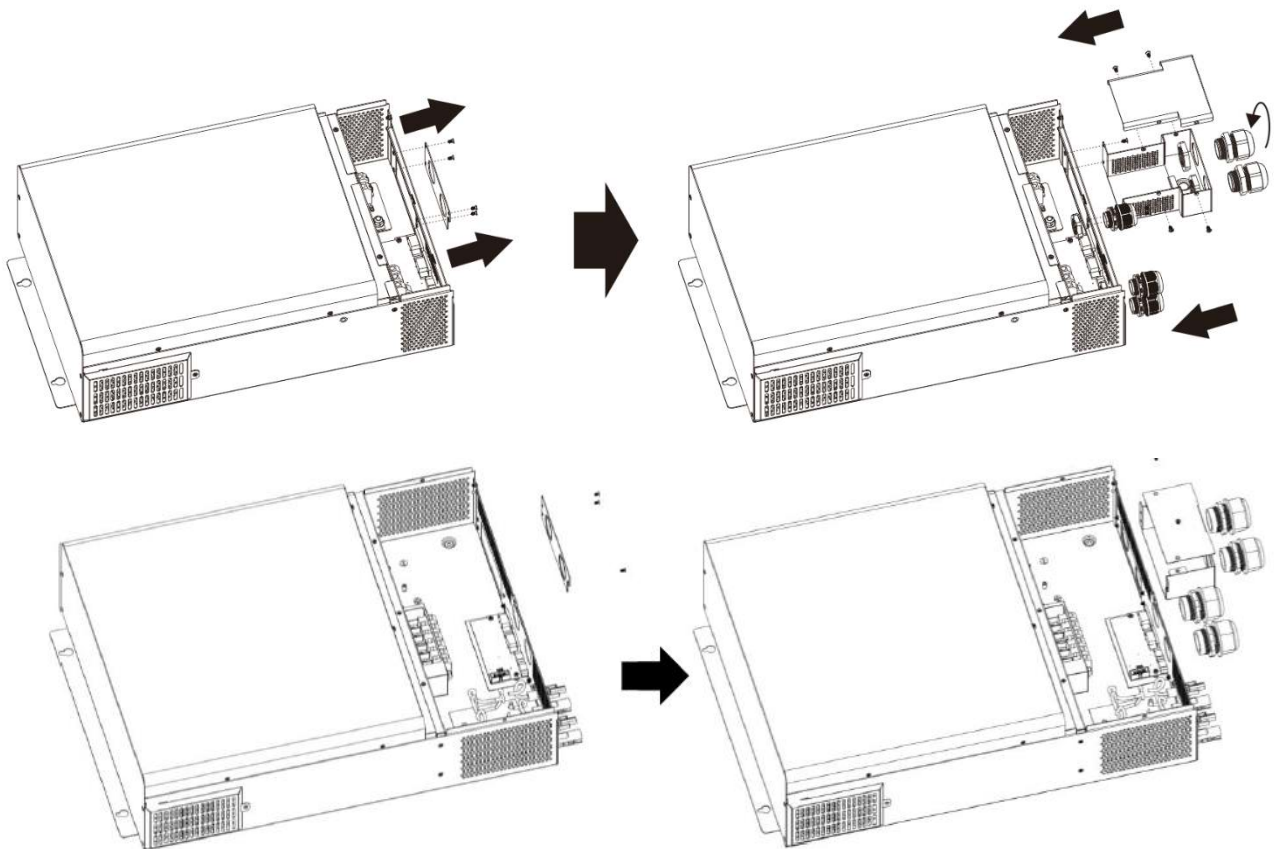

Fig. 3.1: Installation of cable glands and battery wiring extension box (PSW-H-3KW-120/24V and PSW-H-6.5KW-120/48V)

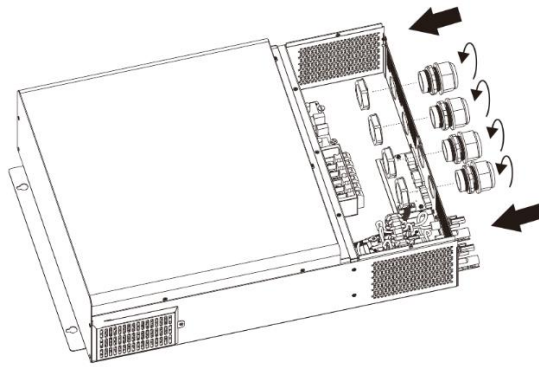
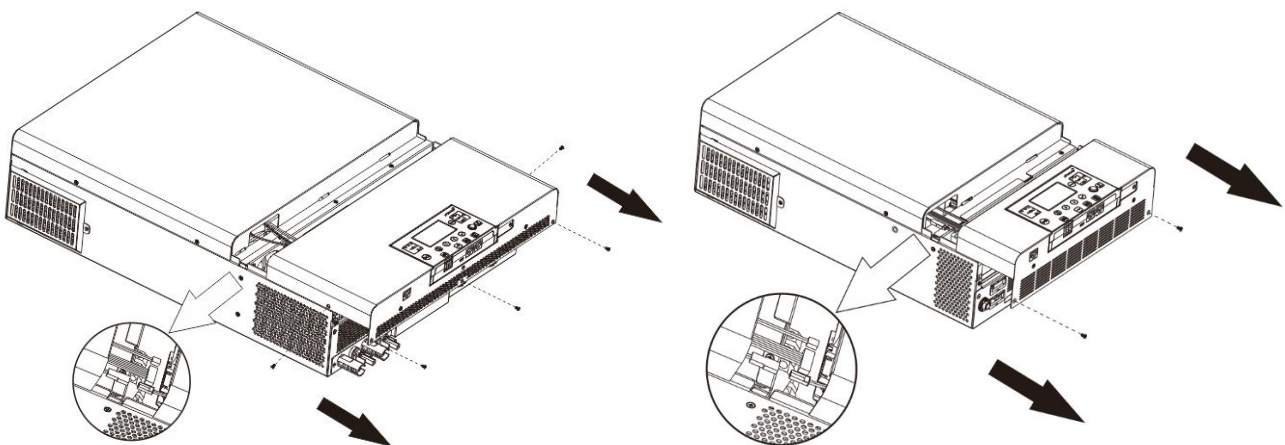

Fig. 3.2: Installation of cable glands (PSW-H-5KW-120/48V and PSW-H-8KW-230/48V)

1. Remove faceplate by removing 4 screws (**Fig. 3**, left).
2. Assemble battery wiring extension box and mount in place of the faceplate (**Fig. 3**, right) with screws.
3. Install the 5 (PSW-H-3KW-120/24V, **Fig. 3.1**, right) or 4 (PSW-H-5KW-120/48V and PSW-H-8KW-230/48V, **Fig. 3.2**) included cable glands.

5.3 Mounting the Unit

Before connecting all wirings, please take off bottom cover by removing five (PSW-H-5KW-120/48V and PSW-H-6.5KW-120/48V) or two (all other models) screws as shown below and carefully sliding the cover down. Before removing the cover entirely, remove the 3 wire harnesses by their connectors (**Fig. 4**).



PSW-H-5KW-120/48V, PSW-H-6.5KW-120/48V
and PSW-H-8KW-230/48V

All other models

Fig. 4: Removal of bottom cover

WARNING: Only mount this unit on concrete or another solid non-combustible surface capable of securely holding the weight of the unit.

- Install this inverter at eye level to ensure legibility of the display
- Ensure the ambient temperature is between -10 ~ 50 °C, 14 ~ 122 °F at all times. In order to fulfill UL requirements, inverters must be operated at an ambient temperature of -10 ~ 40 °C, 14 ~ 104 °F.
- Avoid excessively dusty environments, direct sunlight, and corrosive environments such as salty air.
- The unit is designed for vertical installation on a solid wall

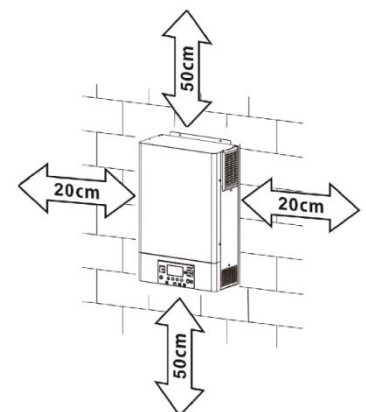

- Ensure a minimum distance to other objects and surfaces as shown in **Fig. 5.1** to guarantee sufficient heat dissipation and to have enough space for removing wires.
- Install in a room where noise is not an issue as the unit has fans for cooling. Under maximum load, the fan noise typically does not exceed 60 dBa. Under no load, but with the AC output turned on, the minimum noise is approximately 35 dBa, as the fans rotate at about 30% of their maximum speed. The fans are speed-controlled according to current PV and inverter power. Air is taken in from the top vents and expelled toward the bottom.

Fig. 5.1: Minimum distance to other objects

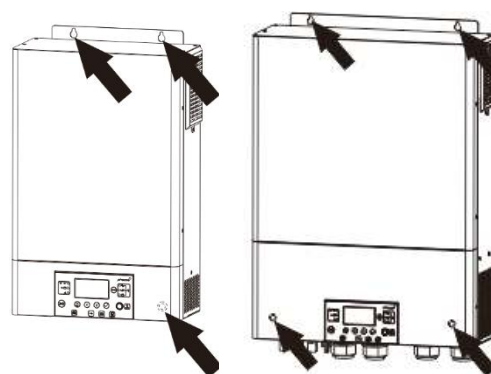

All other models

PSW-H-5KW-120/48V
PSW-H-6.5KW-120/48V
PSW-H-8KW-230/48V

Install the unit by using four (PSW-H-5KW-120/48V, PSW-H-6.5KW-120/48V and PSW-H-8KW-230/48V) or three (all other models) M4 or M5 screws (**Fig. 5.2**) appropriate for the weight of the unit and wall material, use wall plugs. The bottom screw hole is only accessible after removal of the bottom cover (**Fig. 4**). This bottom cover must remain removed for the rest of this “**Installation**” chapter until instructed otherwise.

Fig. 5.2: Mounting holes

5.4 Battery Connection

WARNING: The installation of this unit may only be undertaken by qualified personnel with appropriate training. High voltages in and around the battery and unit can cause serious injury or death. This unit must be installed in accordance with rules and regulations at the site of installation.

WARNING: Choose a suitable battery fuse as outlined in the chapter “Important Safety Information”, section “OVERCURRENT PROTECTION FOR BATTERY”.

WARNING: Ensure the battery cables are sized according to the table below. Inadequate battery cables can cause excessive heat or fire during operation.

Recommended battery cable cross-section, battery size and fuse / DC circuit breaker rating:

Any-Grid model	PSW-H-5KW-230/48V	PSW-H-8KW-230/48V	PSW-H-5KW-120/48V	PSW-H-6.5KW-120/48V	PSW-H-3KW-230/24V	PSW-H-3KW-120/24V
Battery cable cross-section	35 ~ 50 mm ² AWG 0 ~ AWG 2	70 mm ² AWG 2/0	50 mm ² , AWG 0	70 mm ² AWG 2/0	35 ~ 50 mm ² , AWG 0 ~ AWG 2	
Nominal battery voltage	48 Vdc				24 Vdc	
Min. battery capacity (lead-based)	200 Ah					
Battery discharge current capability	140 Adc cont. 280 Adc surge (5s)	184 Adc cont. 368 Adc surge (5s)	115 Adc cont. 280 Adc surge (5s)	154 Adc cont. 308 Adc surge (5s)	168 Adc cont. 336 Adc surge (5s)	168 Adc cont. 336 Adc surge (5s)
Fuse / breaker rating	175 Adc, min. 66 Vdc	230 Adc, min. 66 Vdc	175 Adc, min. 66 Vdc	200 Adc, min. 66 Vdc	210 Adc, min. 33 Vdc	210 Adc, min. 33 Vdc

Steps to connect the battery:

1. **WARNING: Ensure the battery cables are not yet connected to the battery.**
CAUTION: Ensure none of the cable insulation is jammed in the ring terminal before crimping.

Crimp one battery ring terminal (included) to each the positive and negative battery lead (unit side). If choosing ring terminals other than the included ones, make sure they have an inside ring diameter of 8.4 mm, 0.31 in (PSW-H-5KW-120/48V, PSW-H-6.5KW-120/48V and PSW-H-8KW-230/48V) or 6.4 mm, 0.25 in (all other models) to fit the battery terminal bolts of the Any-Grid securely.

- Remove the pre-installed nuts from the battery terminal bolts. Insert the ring terminal of the battery cables through the casing holes (cable glands for 120 Vac models) and flat onto the corresponding battery terminal (**Fig. 6**). Screw down the previously removed nuts with a torque of 5 Nm, 3.7 lbf-ft (PSW-H-5KW-120/48V, PSW-H-6.5KW-120/48V and PSW-H-8KW-230/48V) or 2 ~ 3 Nm, 1.5 ~ 2.2 lbf-ft (all other models). Ensure the ring terminals sit flush on the connectors.

CAUTION: Do not apply any antioxidant substances to the battery terminals of the unit before they are adequately fastened.

CAUTION: Over-tightening the terminal nuts can cause damage to the terminal, under-tightening can cause a loose connection and excessive heat during operation, make sure to use the prescribed torque.

- Install the fuse holder or breaker in the positive battery cable (or negative, if the battery must be positive-grounded).

WARNING: Ensure the fuse is not yet installed or make sure the circuit breaker is secured in the open position for the rest of the installation procedure until instructed to do otherwise.

- Connect the other end of the battery cables to the battery. Ensure the polarity of the battery terminals on the Any-Grid match the battery polarity.

CAUTION: Reverse polarity connection to the battery may damage the unit.

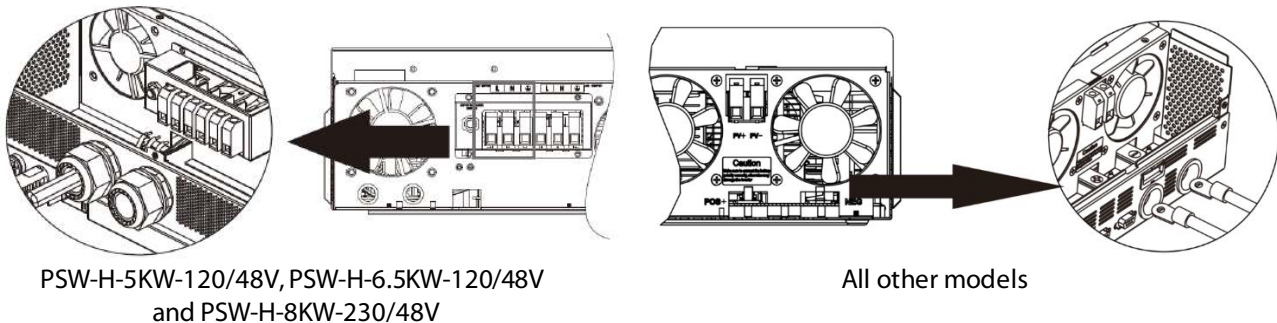

Fig. 6: Battery connection

5.5 AC Input and AC Output Connection

WARNING: Before connecting an AC source to the AC input of the Any-Grid, install an AC circuit breaker between the Any-Grid and AC input power source. This will ensure the inverter can be securely disconnected during maintenance and fully protected from over current of AC input. Make sure the breaker is open / off for the rest of the installation procedure until instructed otherwise.

WARNING: Ensure that the installation has adequate grounding and connect the protective earth (PE) terminals to this ground as instructed below. Failure to do so can cause serious injury or death once the unit is powered up or the AC source is activated via its breaker.

WARNING: Ensure the AC cables are sized according to the table below. Inadequate AC cables can cause excessive heat or fire during operation.

CAUTION: Do not connect an AC source to the "AC OUTPUT" labelled terminal of the unit as this will destroy the unit. Only connect it to the "AC INPUT" labeled terminal.

CAUTION: Only AC sources with a neutral may be used. Using two phases on a single Any-Grid instead, will cause damage.

CAUTION: Short-circuiting the L (live phase) AC input or AC output terminal to the metal body of the unit will cause permanent damage not covered under warranty.

Recommended AC cable cross-section and AC circuit breaker rating:

Any-Grid model	PSW-H-5KW-230/48V	PSW-H-3KW-230/24V	PSW-H-3KW-120/24V	PSW-H-5KW-120/48V PSW-H-6.5KW-120/48V PSW-H-8KW-230/48V
AC input and output cable cross-section	4 ~ 10 mm ² , AWG 7 ~ AWG 11			6 ~ 16 mm ² , AWG 4 ~ AWG 9
Circuit breaker rating	40 Aac ≥ 280 Vac	30 Aac ≥ 280 Vac	40 Aac ≥ 140 Vac	60 Aac, ≥ 280 Vac for PSW-H-8KW-230/48V, 140Vac for 120 Vac models

Steps to connect the AC source and AC loads:

1. **WARNING: Ensure the battery cable fuse is removed or breaker is secured in the open position. WARNING: Ensure the AC source breaker is secured in the open position and there is no voltage on the conductors before continuing.**
2. Remove 10 mm / 0.4 in of insulation for the six AC conductors (neutral "N", live "L" and protective earth "PE" for the AC source and loads).
3. Insert the three AC source wires through the rectangular casing hole (cable gland for 120 Vac models and PSW-H-8KW-230/48V) marked "AC INPUT". Insert the "PE" protective conductor (⊕) first into the corresponding AC input terminal and tighten with a torque of 1.4 ~ 1.6 Nm (1.0 ~ 1.2 lbf·ft). Repeat for the neutral "N" and live "L" conductors.

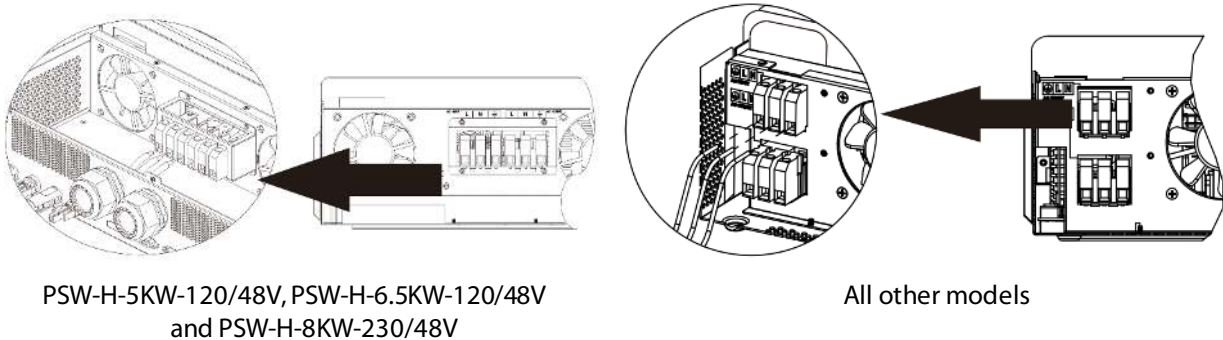

Fig. 7: AC input connection

4. Insert the three AC load wires through the rectangular casing hole (cable gland for 120 Vac models and PSW-H-8KW-230/48V) marked "AC OUTPUT". Insert the "PE" protective conductor (⊕) first into the corresponding AC output terminal and tighten with a torque of 1.4 ~ 1.6 Nm (1.0 ~ 1.2 lbf·ft). Repeat for the neutral "N" and live "L" conductors.

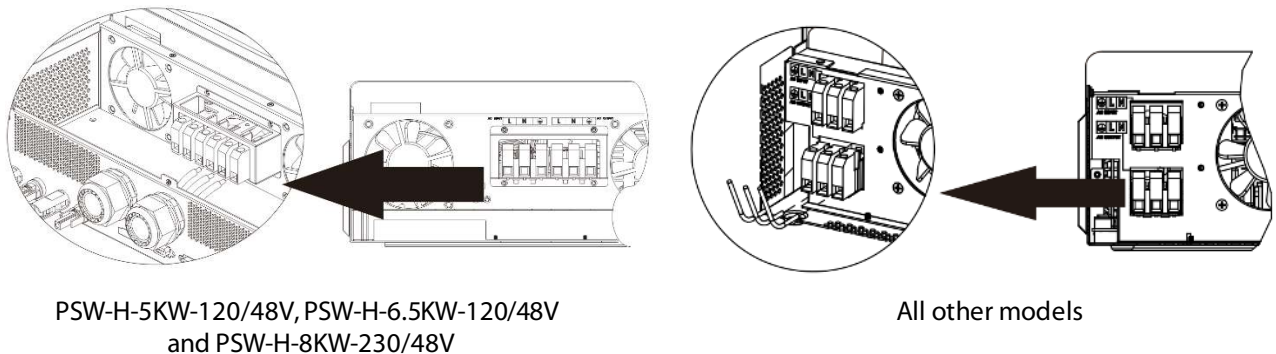

Fig. 8: AC Output connection

5. Make sure the six wires are securely connected.
CAUTION: Over-tightening the terminal screws can cause damage to the terminal, under-tightening can cause a loose connection and excessive heat during operation, make sure to use the prescribed torque. Ensure none of the conductor insulation is jammed between the terminal contacts.
CAUTION: Ensure the polarity is correct on all wires. Failure to do so may cause a short-circuit at the AC source when several units are working in parallel operation.

5.6 PV Connection

WARNING: Before connecting the PV module array to the PV input of the Any-Grid, install a DC circuit breaker between each Any-Grid PV terminal pair and the PV modules. This ensures the inverter can be securely disconnected during maintenance and is protected from over-current of the PV modules. PV modules produce a dangerous voltage even at low light. Make sure the breaker is open / off for the rest of the installation procedure until instructed otherwise.

WARNING: Ensure the PV cables are sized according to the table below. Inadequate PV cables can cause excessive heat or fire during operation.

CAUTION: Short-circuiting the PV+ to the PV- terminal or any of these terminals to the metal body of the unit will cause permanent damage not covered under warranty.

Recommended PV cable cross-section and DC circuit breaker rating:

Any-Grid model	PSW-H-5KW-230/48V PSW-H-3KW-230/24V	PSW-H-3KW-120/24V	PSW-H-5KW-120/48V PSW-H-6.5KW-120/48V	PSW-H-8KW-230/48V
PV cable cross-section	2.5 ~ 16 mm ² , AWG 5 ~ AWG 13		4 ~ 6 mm ² , AWG 10 ~ AWG 12	
Circuit breaker rating	30 Adc, min. 450 Vdc	30 Adc, min. 250 Vdc	25 Adc, min. 250 Vdc per PV input	30 ~ 35 Adc, min. 500 Vdc

For selecting the correct PV module configuration, please consider the following points:

- The total open circuit voltage (Uoc / Voc) of the PV module array may never exceed the values in the table below. Consider the coldest possible temperatures at the installation location together with the temperature coefficient of the PV modules used.
- The total maximum power point voltage (Umpp / Vmpp) of the PV module array must be above the minimum values in the table below. Consider the hottest PV module temperatures at installation location.
- The total maximum power point current (Impp / Amp) of the PV array may not exceed the values below.

Any-Grid model	PSW-H-8KW-230/48V	PSW-H-5KW-230/48V	PSW-H-3KW-230/24V	PSW-H-5KW-120/48V	PSW-H-6.5KW-120/48V	PSW-H-3KW-120/24V
Max. PV voltage (Uoc)	500 Vdc	450 Vdc		250 Vdc		
Min. PV mpp voltage (Umpp)	120 Vdc		90 Vdc			
Max. mpp current (Impp)	30 Adc (up to 27 Adc usable) per input, 40 Adc total max. usable	27.5 Adc (up to 22 Adc actually usable)		27.5 Adc (up to 22 Adc usable) per input, 30 Adc total max. usable	27.5 Adc (up to 22 Adc usable) per input, 36 Adc total max. usable	27.5 Adc (up to 22 Adc actually usable)

Steps to connect the PV module array:

1. PSW-H-5KW-120/48V, PSW-H-6.5KW-120/48V and PSW-H-8KW-230/48V: if the PV array has MC4 connectors, do not remove them. If the array has different connectors, cut them off and remove 8 mm / 0.3 in of insulation from the positive and negative PV cables.
All other models: remove 10 mm / 0.4 in of insulation from the positive and negative PV cables.
2. PSW-H-5KW-120/48V, PSW-H-6.5KW-120/48V and PSW-H-8KW-230/48V: use an MC4 crimping tool to crimp the included MC4 connectors to the PV array (see **Fig. 9.1**, top) if the array does not already have compatible MC4 connectors. *Only use the included MC4 connectors if the PV cable has the cross-section outlined in the first table of this chapter.* Double-check polarity. Then insert the finished MC4 connectors into the PV1 and PV2 connectors on the inverter, positive (+) on the left and negative (-) on the right (see **Fig. 9.1**, bottom).
CAUTION: Ensure correct polarity before connecting. Failure to do so will damage the PSW-H.

All other models: insert the two PV wires through the rectangular casing hole (cable glands for 120 Vac models) marked "PV input". Insert the positive PV cable into the "PV+" terminal and the negative PV cable

into the "PV-" terminal (see Fig. 9.2).

CAUTION: Ensure correct polarity before connecting. Failure to do so will damage the PSW-H.

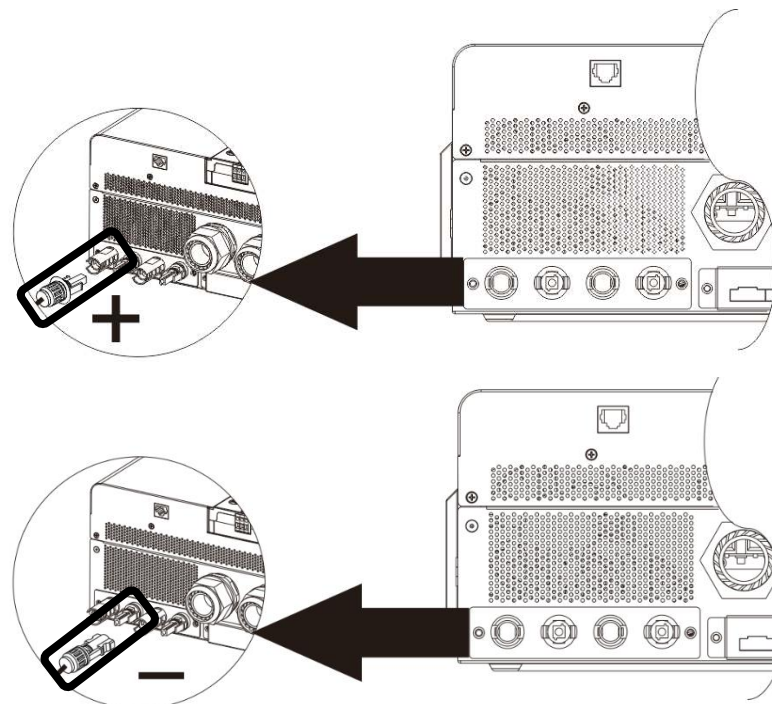
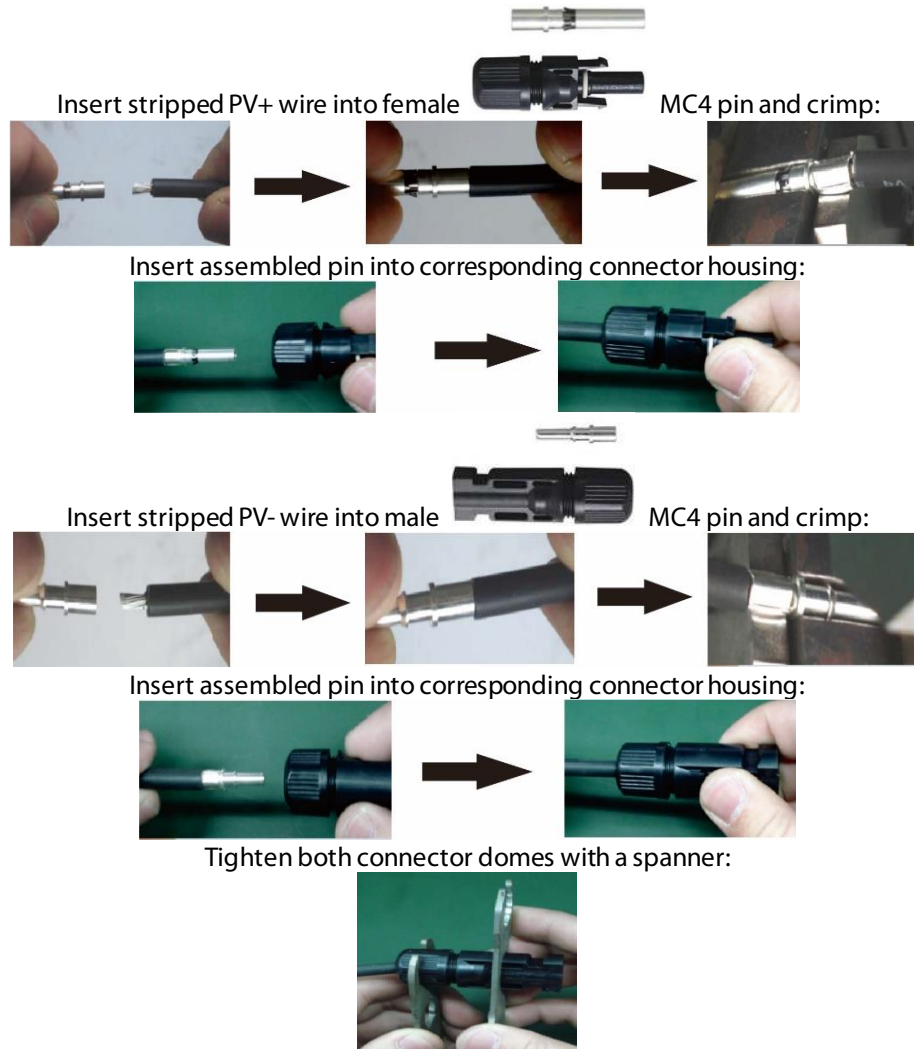

**Fig.9.1: PV connection, PV2 input shown as example
(PSW-H-5KW-120/48V, PSW-H-6.5KW-120/48V and PSW-H-8KW-230/48V)**

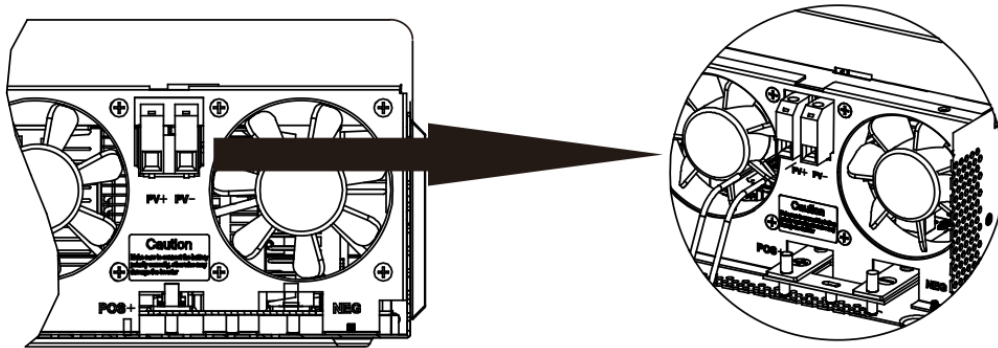

Fig.9.2: PV connection (all other models)

3. All models except PSW-H-5KW-120/48V, PSW-H-6.5KW-120/48V and PSW-H-8KW-230/48V: Tighten both PV terminal screws with a torque of 1.4 ~ 1.6 Nm (1.0 ~ 1.2 lbf-ft) and make sure the two wires are securely connected.

CAUTION: Over-tightening the terminal screws can cause damage to the terminal, under-tightening can cause a loose connection and excessive heat during operation, make sure to use the prescribed torque. Ensure none of the cable insulation is jammed between the terminal contacts.

4. If using the PSW-H-5KW-120/48V, PSW-H-6.5KW-120/48V or PSW-H-8KW-230/48V, repeat step 1 and 2 for the second PV terminal pair and a second PV array, if available.

CAUTION: If using two PV arrays for this model, they must be independent. The positive and negative terminals of the two PV arrays may not touch each other anywhere in the system.

5.7 Final Assembly

After Battery, PV and AC wiring is completed, please slide the bottom cover back up on the unit, re-connect the 3 wire harnesses removed in **Fig. 4**, and secure it by fastening the five (PSW-H-5KW-120/48V, PSW-H-6.5KW-120/48V and PSW-H-8KW-230/48V) or two (all other models) screws as shown below.

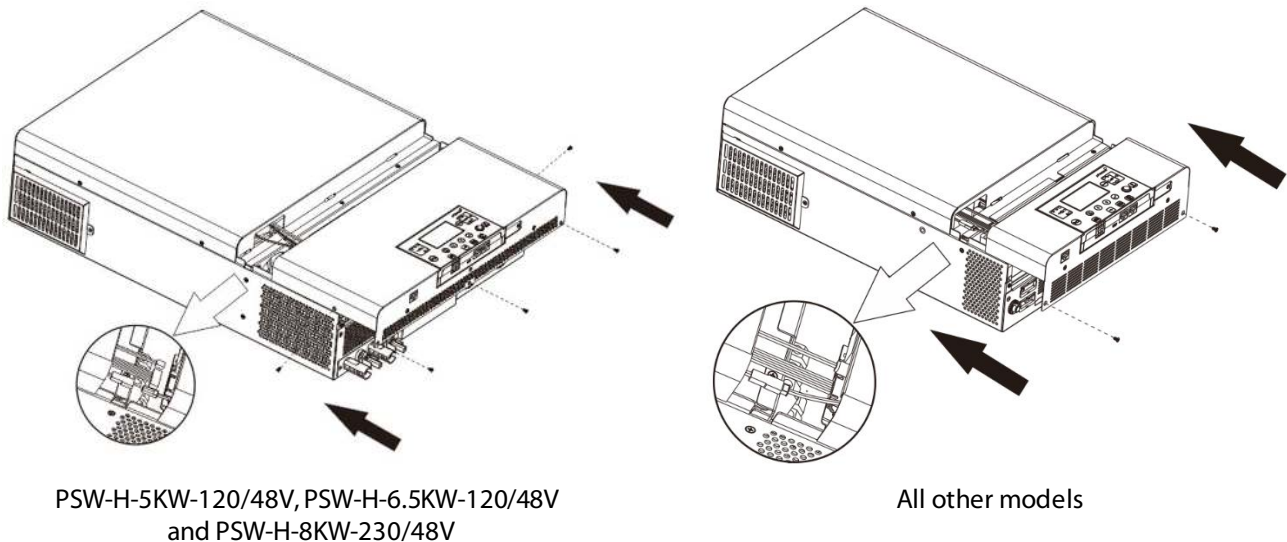

PSW-H-5KW-120/48V, PSW-H-6.5KW-120/48V
and PSW-H-8KW-230/48V

All other models

Fig. 10: Re-applying bottom cover

5.8 Remote Display Panel Installation

The display module can optionally be removed and installed in a remote location with an optional communication cable. Please take the following steps to implement this remote panel installation. Use a standard straight Ethernet patch cable (Cat5 or higher) with male RJ45 connectors on both sides (not included). A maximum cable length of 20 meters or 66 feet is recommended. Follow the steps below to remove the display module and install it away from the inverter unit.

1. Remove the screw holding the bracket on the bottom of the display module (**Fig. 11** → ①) and push down the display unit from the case slightly while removing the metal bracket.
2. Keep pushing the display module down, taking care not to damage the connected cable (**Fig. 11** → ②).

- Remove the cable connected to the display module (Fig. 11 → ③).
- Screw the bracket removed in Fig. 11 → ① back in place (Fig. 11 → ④).

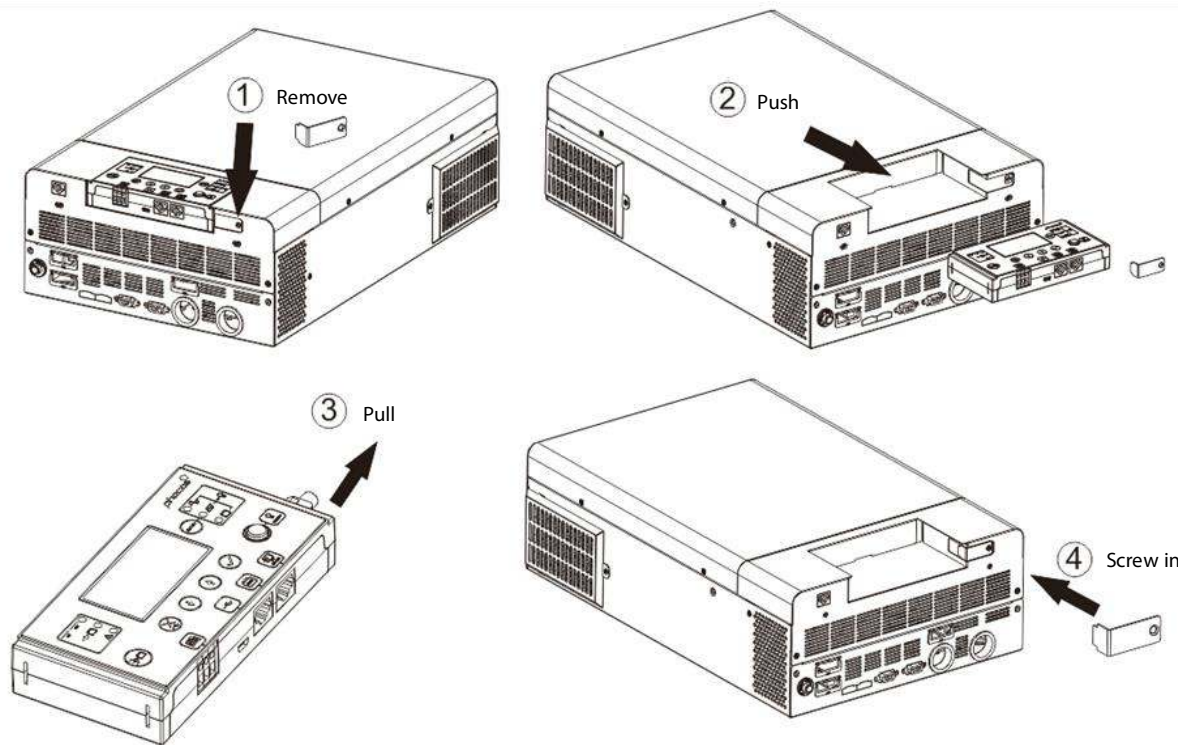

Fig. 11: Remote display removal

- Drill the three mounting holes in the marked distances of 70 mm, 2.76 in into each other (Fig. 12, left). Use M3, size no. 4 diameter screws. The screw heads must be between 5 ~ 7 mm, 0.2 ~ 0.3 in. Screw the bottom two screws into the wall where the display module is to be mounted and let the screw heads protrude 2 mm, 0.08 in. from the wall. Slide the display down on the protruding screw heads. Now insert and tighten the third screw at the top (Fig. 12, right).

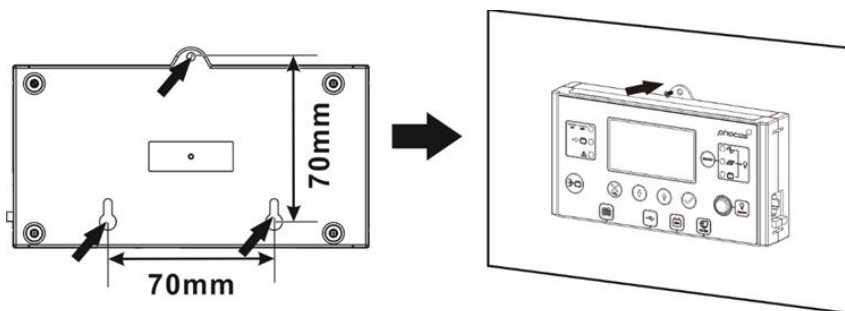

Fig. 12: Remote display mounting hole locations

- Install one end of the Ethernet patch cable (not included) into socket ⑫ (Fig. 2, top right) on the display module (right side). Install the other end of the Ethernet patch cable into socket ⑫ (Fig. 2, bottom left) on the Any-Grid unit.
- If using Lithium batteries designed for battery management system (BMS) communication such as Pylontech batteries, please visit www.phocos.com for a current list of batteries supported with BMS communication. Connect the special battery BMS cable (ask your dealer for details) to socket ⑮ (Fig. 2). **CAUTION: Ensure the battery and BMS is compatible with the Any-Grid and that the pin location is correct before connection. Damage to any communication port or the battery due to incorrect connection or cables is not covered by warranty. Do not use any inverter communication cables included with your battery, consult your Phocos dealer for appropriate Any-Grid cables instead.**

Pin (see Fig. 2)	1	2	3	4	5	6	7	8
Function	RS-232 RX	RS-232 TX	RS-485 B	+12 Vdc	RS-485 A	CAN H	CAN L	GND

5.9 Installing Multiple Units in Parallel, Split Phase or 3-Phase Configuration

Introduction

This entire chapter is only relevant if using more than one Any-Grid unit. Multiple Any-Grid units of the same model number can be used either in parallel on a single phase, split-phase / 2-phase (only 120Vac models), or in a 3-phase configuration with a common neutral. All units must be connected to the same battery bank. This chapter is an addition to all other sections above in the chapter “Installation”, please adhere to all guidelines and safety instructions in those sections accordingly.

Parallel operation on a single phase is possible with up to 9 units.

Alternatively, 3-phase configuration is possible, whereby at least one unit must be installed on each of the 3 phases with a maximum of 7 units on a phase. The total number of units may not exceed 9 in any case.

For 120 Vac models split-phase (2-phase) operation is possible whereby at least one unit must be installed on each of the 2 phases with a maximum of 8 units on a phase. The total number of units may not exceed 9 in any case.

CAUTION: If using an AC source, each unit must be connected to a neutral and a phase conductor, never two phases.

Mounting the Units

When installing multiple units, please keep a minimum distance between the units as shown in **Fig. 13**.

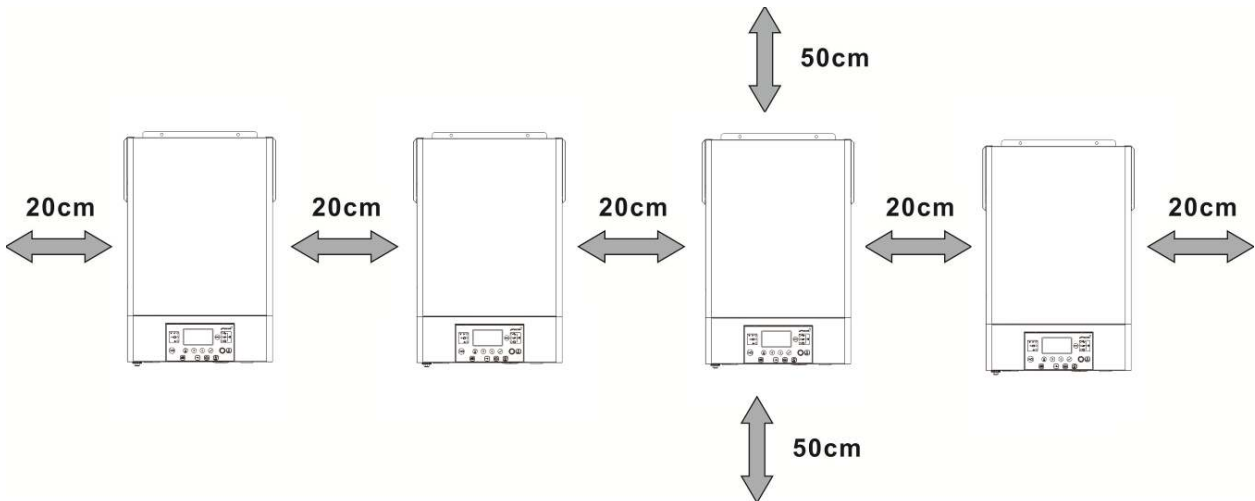

Fig. 13: Minimum distance between units and to other objects

Connections

Use the cable cross-sections, tightening torque and connectors as described for a single unit.

Battery Connection: Make sure to use a separate DC fuse or circuit breaker for each unit. Instead of connecting each unit to the battery, connect each positive battery cable to a bus bar, and each negative battery cable to a second bus bar. These bus bars are then connected to the battery terminals. The cross-section of the bus bars, and the cables from the bus bars to the battery terminals should equal the recommended battery cable cross-section per unit, times the number of units connected to it.

The minimum recommended battery capacity for lead-based batteries is 200 Ah per connected Any-Grid. For example, in a system with 3 units, the battery bank should have a capacity of at least 600 Ah.

CAUTION: All inverters must share the same battery bank. Otherwise, the inverters will go into fault mode.

CAUTION: Please install at least a breaker at the battery terminals and AC input of every individual Any-Grid unit. This will ensure each unit can be securely disconnected during maintenance and fully protected from over-current of battery or AC input. Use the breaker ratings as described in the chapters “Battery Connection” and “AC Input and AC Output Connection”.

AC Connections: Regarding AC input and output, please also follow the same principle. Use the wiring cross-section and circuit breaker as defined for each individual unit, then attach those wires to bus bars. The bus bars from the AC

input are then connected to the AC source, the bus bars from the AC output are connected to the distribution panel and loads.

PV Connections: Use the PV connection as described for individual units. Each unit must be connected to its own PV array and must not have any electrical contact to any other units' PV arrays.

CAUTION: Connecting a single PV array to multiple Any-Grids simultaneously will damage the Any-Grid units. If using PV, each unit must be connected to its own individual PV array, not electrically shared with any other units.

WARNING: Ensure all circuit breakers are open / disabled before wiring the units so that there is no voltage on all battery, AC and PV wires.

General rules for the communications connections (see **Fig. 2** → 13 Parallel Communication Port and 14 Current Sharing Port):

1. Every unit must have both parallel communication ports occupied. These ensure phase synchronization and synchronization of parameters between the units.
2. Current sharing ports must only be occupied for those units where there is more than one unit on that particular phase. If there is only one unit on a phase, then current sharing cables must not be used. These current sharing cables ensure that all units on one phase operate at the same AC power output level.
3. Every parallel communication or current sharing cable used, must either be connected directly between two neighboring units, or with a maximum of one unit between them.
4. Connecting parallel communication cables, assuming units are numbered from 1 to ≤ 9 from left to right:
 - a) Connect the left black parallel communication port of unit 1 to the right port on unit 2.
 - b) Connect the right port of unit 1 to the left port of unit 3.
 - c) Connect the left port of unit 2 to the to the right port of unit 4.
 - d) Continue connecting the right port of each odd-numbered unit to the left port of the next odd-numbered unit. Continue connecting the left port of each even-numbered to the right port of the next even-numbered unit, until there are only two unoccupied black ports.
 - e) Connect the unoccupied black port of the last unit to the unoccupied black port of the second-to-last unit.
5. Connecting current sharing cables just like step 4, assuming units are numbered from 1 to ≤ 9 from left to right on a particular phase (there must be no connection of current sharing cables between any two phases' units!):
 - a) Connect the left green current sharing port of unit 1 to the right port on unit 2.
 - b) Connect the right port of unit 1 to the left port of unit 3.
 - c) Connect the left port of unit 2 to the to the right port of unit 4.
 - d) Continue connecting the right port of each odd-numbered unit to the left port of the next odd-numbered unit. Continue connecting the left port of each even-numbered to the right port of the next even-numbered unit, until there are only two unoccupied green ports on the particular phase.
 - e) Connect the unoccupied green port of the last unit to the unoccupied green port of the second-to-last unit.
 - f) Repeat steps 5a to 5e for further phases with more than one unit.

The following section will show a few examples of how the parallel communication and current sharing cables are mounted. For better visibility download this manual in color at www.phocos.com.

Once commissioning is completed, the following settings menus (see chapter "**Device Operation Settings**") are automatically synchronized between all units: 01, 02, 03, 05, 06, 07, 08, 09, 10, 12, 13, 23, 26, 27, 29, 30, 32, 33, 34, 35, 36, 37, 39 and 41. All settings not mentioned here, and priority timers, can be set on each unit individually.

Example: 5 Units on Single Phase

Note: this example excludes circuit breakers, SPDs, RCDs and bus bars for better visibility.

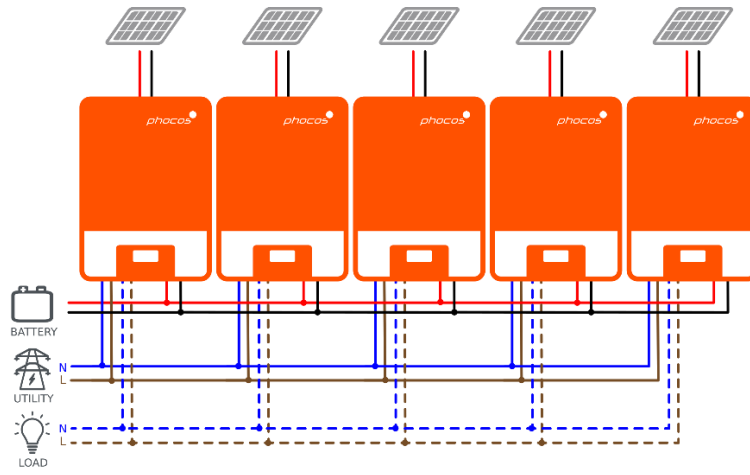

Fig. 14: Power connections of 5 units on a single phase

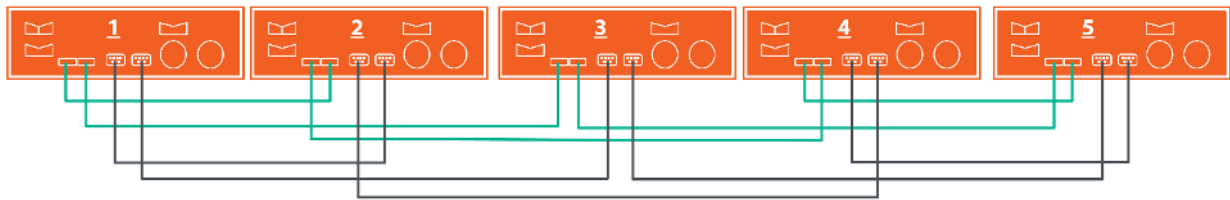

Fig. 15: Communication connections of 5 units on a single phase

Example: 7 Units on Phase 1, 1 Unit on Phase 2, 1 Unit on Phase 3

Note: this example excludes circuit breakers, SPDs, RCDs and bus bars for better visibility.

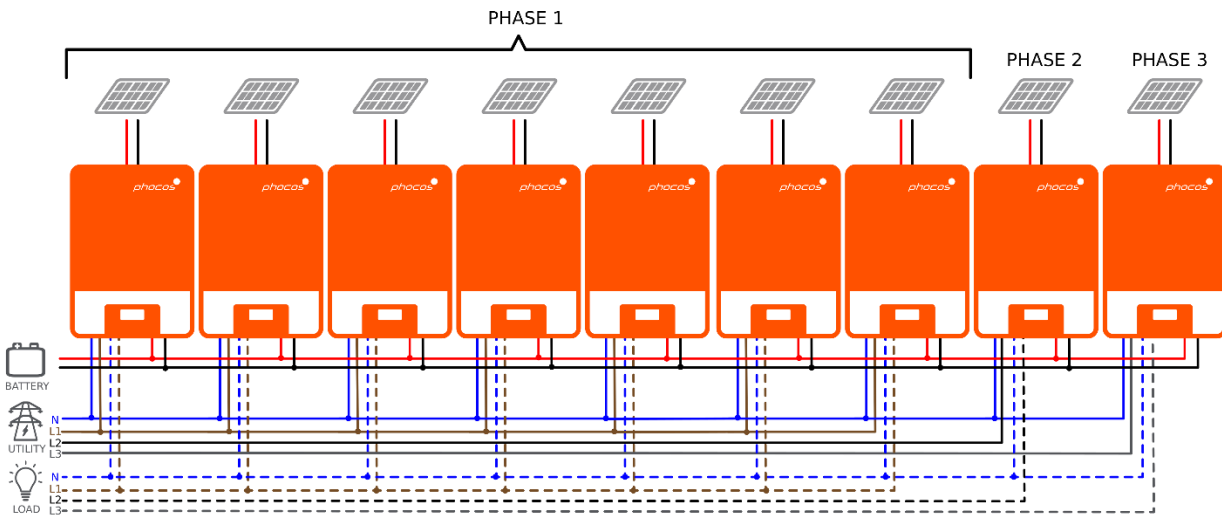

Fig. 16: Power connections of 7 units on P1, 1 unit on P2, 1 unit on P3

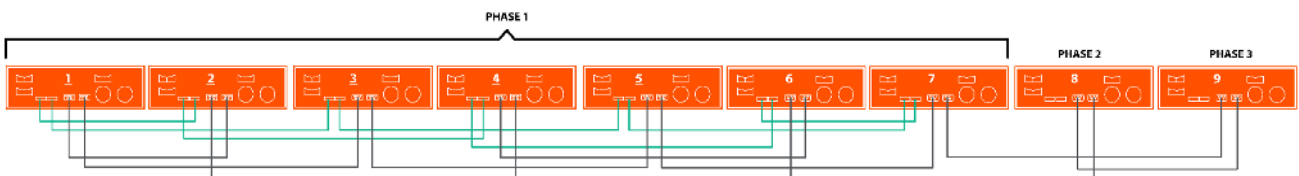

Fig. 17: Communication connections of 7 units on P1, 1 unit on P2, 1 unit on P3

Notice that because there is only one unit on phase 2 (P2) and phase 3 (P3), there are no green current sharing cables connected to these two units.

Example: 4 Units on Phase 1, 4 Units on Phase 2 (split-phase)

Note: this example excludes circuit breakers, SPDs, RCDs and bus bars for better visibility.

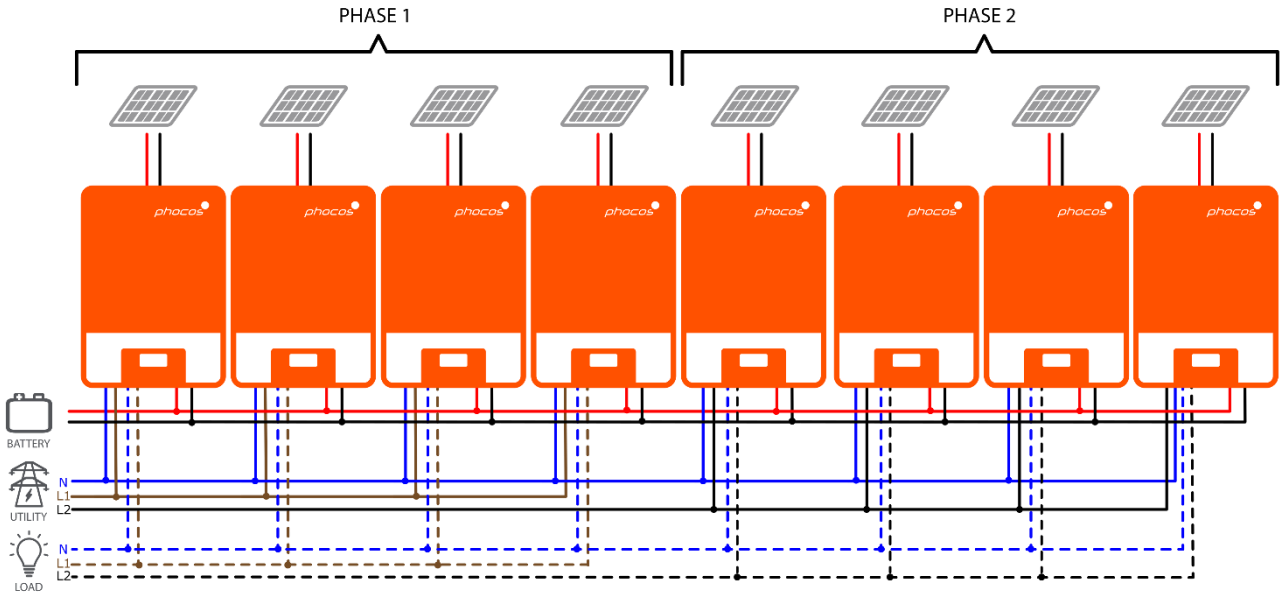

Fig. 18: Power connections of 4 units on P1, 4 units on P2

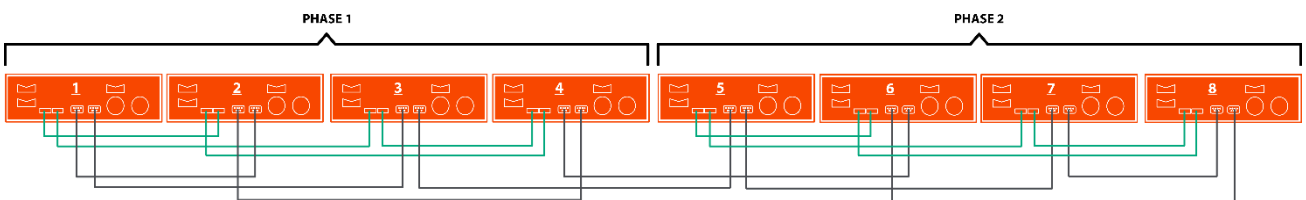



Fig. 19: Communication connections of 4 units on P1, 4 units on P2

Commissioning

CAUTION: Before continuing, ensure the wiring is correct according to the previous chapter. Particularly that all units are connected to the same neutral wire at the AC input and all AC output neutral terminals are connected to a separated common neutral wire. Ensure that all AC input breakers and AC output breakers are open on each individual Any-Grid unit and that each unit is turned off with its AC output on/off switch. Ensure each unit is disconnected from PV and the battery via its battery breaker / fuse.

Parallel in Single Phase

Follow these steps once the wiring is completed:

1. If PV is available, switch it on with its breaker. If an AC source is available, switch it on with its AC input breaker. The turn on the battery breaker /insert the fuse. Finally, turn on one unit with its AC output on/off switch.
2. In the Settings Menu (see chapter “**Device Operation Settings**”) navigate to settings menu 28.
3. Turn the AC output on/off switch off to deactivate the AC output. The unit will remain in Stand-By mode for under a minute and the display will stay on for this time.
4. Set the menu number 28 setting from the default value “Single” (SIG) to “Parallel” (PAL). This will not be possible if the unit is not turned off as described in the previous step. Press  so the entry stops blinking. Now press the  button to accept the new setting and return to the main view.
5. Switch off the PV and AC input breaker if they were on. Wait for the unit to shut down automatically, the display will then turn off completely.
6. Repeat steps 1 to 5 with each further unit connected in parallel.
7. Now turn on each unit. One unit will automatically and randomly be defined as the host unit and will show

the host screen, all other units will show the client screen on their display:

Screen of Host unit	Screen of Client unit(s)

- Switch on the AC input breaker of each unit in quick succession, if an AC source is installed. If this takes too long, then some units may show fault 82 on their screen, but they will restart automatically and upon detecting a valid AC input, will function normally. The displays will show the following:

Screen of Host unit	Screen of Client unit(s)

- If there are no further faults displayed, the parallel system installation is complete. The breakers on the AC output of each unit can be switched on and then loads may be connected.

3-Phase, One or more Units per Phase

Follow these steps once the wiring is completed:

- If PV is available, switch it on with its breaker. If an AC source is available, switch it on with its AC input breaker. The turn on the battery breaker /insert the fuse. Finally, turn on one unit with its AC output on/off switch.
- In the Settings Menu (see chapter “**Device Operation Settings**”) navigate to settings menu 28.
- Turn the AC output on/off switch off to deactivate the AC output. The unit will remain in Stand-By mode for under a minute and the display will stay on for this time.
- Set the menu number 28 setting from the default value “Single” (SIG) to “Phase L1” (3P1). This will not be possible if the unit is not turned off as described in the previous step. Press so the entry stops blinking. Now press the button to accept the new setting and return to the main view.
- Switch off the PV and AC input breaker if they were on. Wait for the unit to shut down automatically, the display will then turn off completely.
- Repeat steps 1 to 5 with each further unit connected on the same phase 1. Then repeat steps 1 to 5 for each unit in phase 2 and, instead of choosing “Phase L1” in step 4, choose “Phase L2” (3P2). Then repeat steps 1 to 5 for each unit in phase 3 and, instead of choosing “Phase L1” in step 4, choose “Phase L3” (3P3).
- Now turn on each unit. The units will show the following in their respective screens:

Screen of Units on Phase L1	Screen of Units on Phase L2	Screen of Units on Phase L3

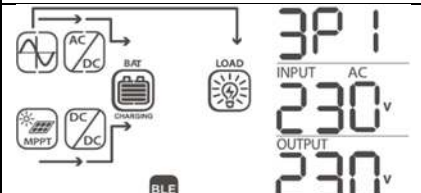
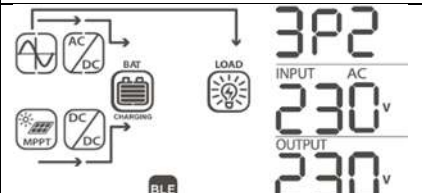
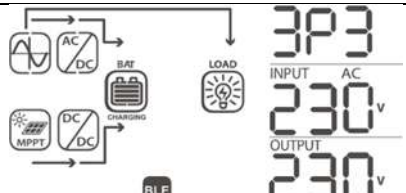

- Switch on the AC input breaker of each unit in quick succession, if an AC source is installed. If this takes too long, then some units may show fault 82 on their screen, but they will restart automatically and upon detecting a valid AC input, will function normally.
- If a valid AC input source is detected and the three phases match with the unit settings in settings menu number 28, they will work normally. Otherwise, the  symbol will flash and Grid Mode will not function. In this case, check that the order or the three phases is correct. If necessary, turn off all units and then switch the setting in settings menu number 28 for all Phase L2 units to Phase L3 and vice-versa by following steps 1 to 5. Then continue with step 7. The displays will now show the following:

Screen of Units on Phase L1	Screen of Units on Phase L2	Screen of Units on Phase L3
		

- If there are no further faults displayed, the 3-phase system installation is complete. The breakers on the AC output of each unit can be switched on and then loads may be connected.

Split-Phase (2-Phase), One or more Units per Phase

Follow these steps once the wiring is completed:

- If PV is available, switch it on with its breaker. If an AC source is available, switch it on with its AC input breaker. Then turn on the battery breaker /insert the fuse. Finally, turn on one unit with its AC output on/off switch.
- In the Settings Menu (see chapter “**Device Operation Settings**”) navigate to settings menu 28.
- Turn the AC output on/off switch off to deactivate the AC output. The unit will remain in Stand-By mode for under a minute and the display will stay on for this time.
- Set the menu number 28 setting from the default value “Single” (SIG) to “Phase L1 for split-phase” (2P1). This will not be possible if the unit is not turned off as described in the previous step. Press  so the entry stops blinking. Now press the  button to accept the new setting and return to the main view.
- Switch off the PV and AC input breaker if they were on. Once the setting is confirmed, wait for the unit to shut down automatically, the display will then turn off completely.
- Repeat steps 1 to 5 with each further unit connected on the same phase 1. Then repeat steps 1 to 5 for each unit in phase 2 and, instead of choosing “Phase L1 for split-phase” in step 4, choose “Phase L2 for split-phase” (2P2).
- Now turn on each unit. The units will show the following in their respective screens:

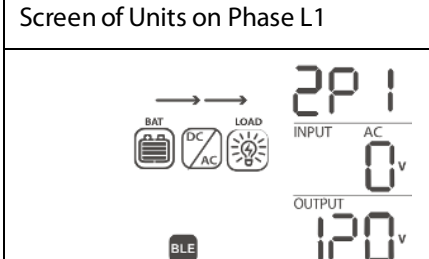
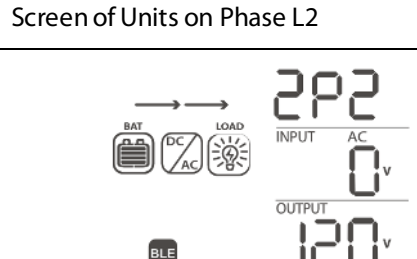
Screen of Units on Phase L1	Screen of Units on Phase L2
	

- Switch on the AC input breaker of each unit in quick succession if an AC source is installed. If this takes too long, then some units may show fault 82 on their screen, but they will restart automatically and upon detecting a valid AC input, will function normally. The displays will show the following:

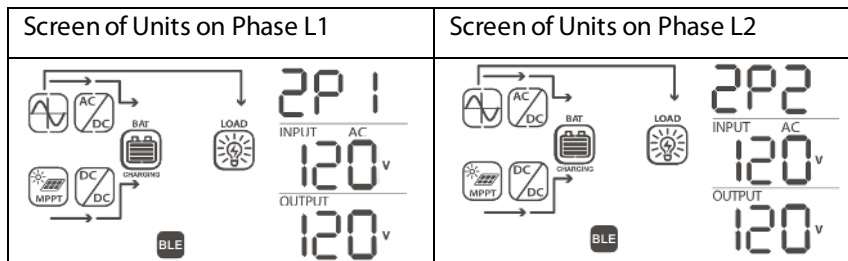

9. If there are no further faults displayed, the split-phase system installation is complete. The breakers on the AC output of each unit can be switched on and then loads may be connected.

6.0 BLE Communication



Google Play™

This unit is equipped with wireless BLE functionality. Download the “PhocosLink Mobile” App from the Google Play™ store or Apple’s App Store® with an Android™ or iOS device, respectively. Once the App is installed, use “pair your device” with the built-in BLE functionality of your device to connect to the Any-Grid unit with the BLE pairing password “123456”. Then open the app and connect to the Any-Grid. The typical maximum communication distance is approximately 6 ~ 7 meters.



Apple App Store®

7.0 Relay Contact

There is one potential-free relay contact (3A / 250Vac) available on the display module (**Fig. 2** → **15**). It may be used to signal an external device when battery voltage reaches a low level, such as a gasoline or diesel generator. The relay may be wired with normally closed (NC) or normally open (NO) logic. The table below indicates the relay states between the common (C) and NO, as well as between C and NC contacts.

Any-Grid Status	Condition		Relay terminals:		
			NC & C	NO & C	
Powered Off or Battery-free mode	Unit is off and AC output is not powered.		Closed	Open	
Powered On	Output is powered from Battery power or Solar power.	Settings Menu 01 set as “Utility / AC input first” (USB) or “Solar / PV first” (SUB)	Battery voltage < Low DC warning voltage (2Vdc for the 48V model / 1Vdc for the 24V model above the value in settings menu 29)	Open	Closed
			Battery voltage > Settings menu 13 or battery charging reaches Floating phase	Closed	Open
		Settings Menu 01 is set as SBU	Battery voltage < Settings menu 12	Open	Closed
			Battery voltage > Settings menu 13 or battery charging reaches Floating phase	Closed	Open

8.0 Operation

8.1 Inverter Power ON/OFF

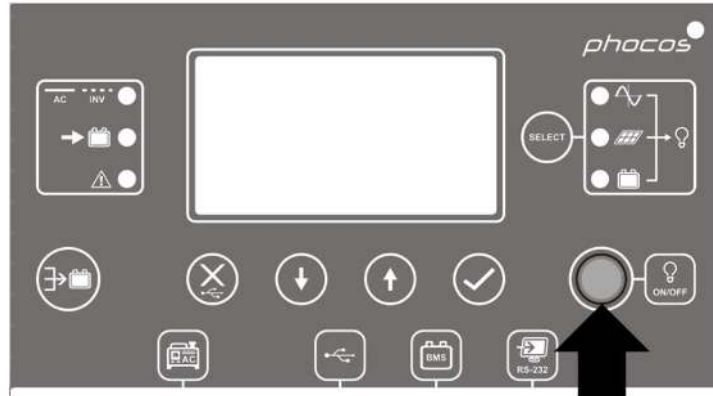

Fig.20: Display module ON/OFF load button location

Ensure the “ON/OFF” switch located on the display module (**Fig.20**) is in the “OFF” position after the initial installation (the button must not be depressed).

Now activate the circuit breakers or insert the fuses to energize the various inputs and outputs in the following order (skip any that are not connected):

1. AC input
2. PV input
3. Battery
4. AC output

Next, press the “ON/OFF” switch to turn on the AC output and thus connected AC loads and the entire unit.

If the “ON/OFF” switch is in the “OFF” position, then the unit will be completely off when there is insufficient sunlight. If PV modules are connected and there is sufficient PV voltage, the unit and display will wake up automatically to charge the batteries during the day. Once the PV voltage drops below the threshold, the unit will again turn completely off to save energy during the night. The AC output and thus the AC loads will remain off as long as the “ON/OFF” switch is in the “OFF” position.

8.2 Display and Control Module

The display and control module, shown in **Fig.21**, includes six LED indicators, six function buttons, an ON/OFF button, and an LCD screen, indicating the operating status and allowing the programming of settings parameters.

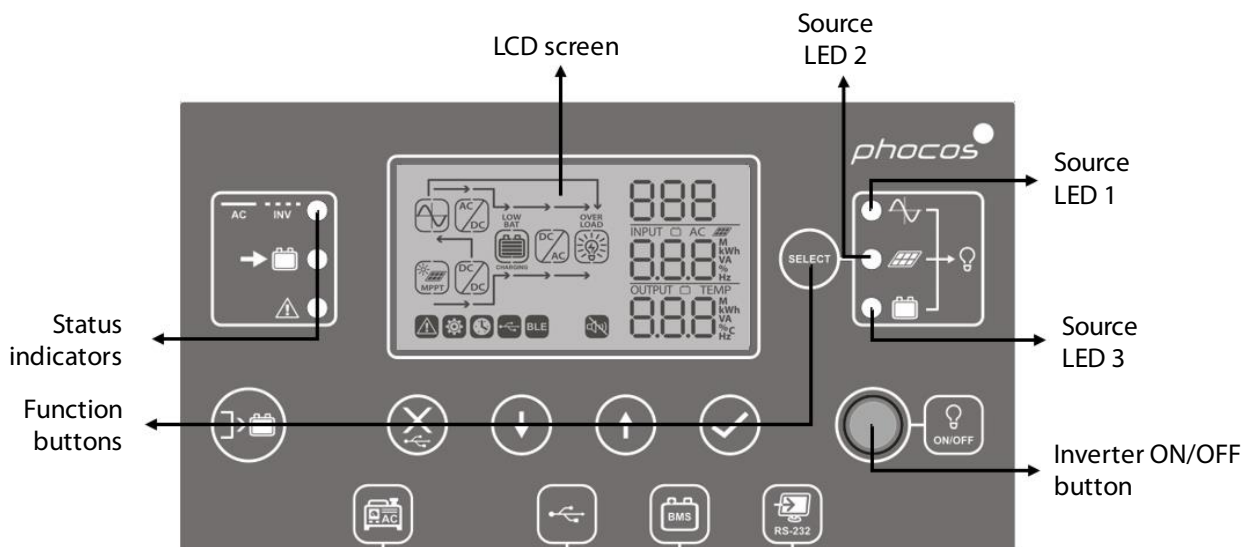











Fig.21: Display module buttons and indicators

Indicator Description

LED Indicator	Color	Solid On / Flashing	Description
Source LED 1	Green	Solid On	AC output powered by AC input
Source LED 2	Green	Solid On	AC output powered by PV
Source LED 3	Green	Solid On	AC output powered by battery
Status indicators		Green Solid On	AC output powered by AC input (Grid mode)
		Green Flashing	AC output powered by integrated inverter (Off-Grid mode)
		Green Solid On	Battery is fully charged
		Green Flashing	Battery is charging
		Red Solid On	Fault mode
		Red Flashing	Warning mode

Function Buttons

Function Button	Description	
	Escape / close	Exit settings without confirming
	USB function setting	Select USB-OTG functions
	Timer setting for AC output source priority	Setup timer for prioritizing AC output source
	Timer setting for the battery charger source priority	Setup timer for prioritizing battery charger source
	Up	To last selection
	Down	To next selection
	Enter	To confirm/enter the selection in setting mode

8.3 Display Symbols

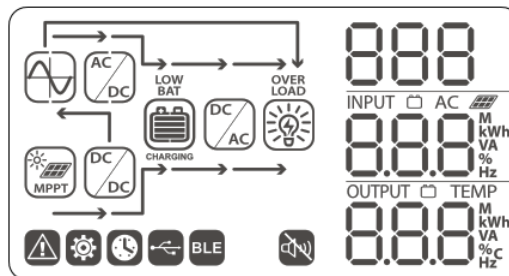

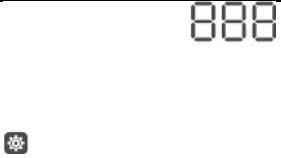
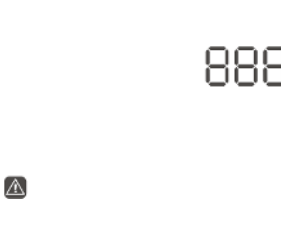

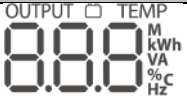
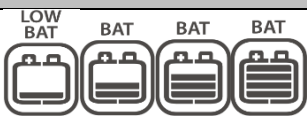

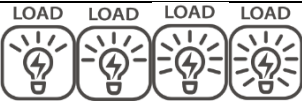











Fig. 22: LCD screen symbols





Symbol	Description
Input Information	
AC	Indicates AC input
	Indicates PV input

	Indicates input voltage, input frequency, PV voltage, charging current, charging power, battery voltage.																					
Settings menu and Fault Information																						
	Indicates the setting menus																					
	Indicates warning and fault codes. Warning:  flashing with warning code. Fault: F88 shown with fault code.																					
Output Information																						
	Indicates output voltage, output frequency, load in % of nominal power, load in VA, load in Watt and discharging current.																					
Battery Information																						
	Indicates battery level in 0 ~ 24%, 25 ~ 49%, 50 ~ 74% and 75 ~ 100% (left to right) increments.																					
While the battery is charging, the battery indicator shows the following:																						
<table border="1"> <thead> <tr> <th>Status</th> <th>Battery voltage (48 V model / 24 V model)</th> <th>LCD Display</th> </tr> </thead> <tbody> <tr> <td rowspan="4">All battery charging modes except Floating phase</td> <td>< 48V / < 24V</td> <td>4 bars flash in turns</td> </tr> <tr> <td>48 ~ 50V / 24 ~ 25V</td> <td>Bottom bar constantly on and other three bars flash in turns</td> </tr> <tr> <td>50 ~ 52V / 25 ~ 26V</td> <td>Bottom two bars constantly on and other two bars flash in turns</td> </tr> <tr> <td>> 52V / > 26V</td> <td>Bottom three bars constantly on and top bar flashes</td> </tr> <tr> <td colspan="2">Floating phase. Batteries are fully charged.</td> <td>4 bars constantly on</td> </tr> </tbody> </table>	Status	Battery voltage (48 V model / 24 V model)	LCD Display	All battery charging modes except Floating phase	< 48V / < 24V	4 bars flash in turns	48 ~ 50V / 24 ~ 25V	Bottom bar constantly on and other three bars flash in turns	50 ~ 52V / 25 ~ 26V	Bottom two bars constantly on and other two bars flash in turns	> 52V / > 26V	Bottom three bars constantly on and top bar flashes	Floating phase. Batteries are fully charged.		4 bars constantly on							
Status	Battery voltage (48 V model / 24 V model)	LCD Display																				
All battery charging modes except Floating phase	< 48V / < 24V	4 bars flash in turns																				
	48 ~ 50V / 24 ~ 25V	Bottom bar constantly on and other three bars flash in turns																				
	50 ~ 52V / 25 ~ 26V	Bottom two bars constantly on and other two bars flash in turns																				
	> 52V / > 26V	Bottom three bars constantly on and top bar flashes																				
Floating phase. Batteries are fully charged.		4 bars constantly on																				
While the battery is discharging, the battery indicator shows the following:																						
<table border="1"> <thead> <tr> <th>Load Percentage</th> <th>Battery voltage (48 V model / 24 V model)</th> <th>LCD screen</th> </tr> </thead> <tbody> <tr> <td rowspan="4">Load > 50%</td> <td>< 44.4 / < 22.2V</td> <td>0 ~ 24%</td> </tr> <tr> <td>44.4 ~ 46.4V / 22.2 ~ 23.2V</td> <td>25 ~ 49%</td> </tr> <tr> <td>46.4 ~ 48.4V / 23.2 ~ 24.2V</td> <td>50 ~ 74%</td> </tr> <tr> <td>> 48.4V / > 24.2V</td> <td>75 ~ 100%</td> </tr> <tr> <td rowspan="4">Load < 50%</td> <td>< 45.4 / 22.7V</td> <td>0 ~ 24%</td> </tr> <tr> <td>45.4 ~ 47.4V / 22.7 ~ 23.7V</td> <td>25 ~ 49%</td> </tr> <tr> <td>47.4 ~ 49.4V / 23.7 ~ 24.7V</td> <td>50 ~ 74%</td> </tr> <tr> <td>> 49.4V / > 24.7V</td> <td>75 ~ 100%</td> </tr> </tbody> </table>	Load Percentage	Battery voltage (48 V model / 24 V model)	LCD screen	Load > 50%	< 44.4 / < 22.2V	0 ~ 24%	44.4 ~ 46.4V / 22.2 ~ 23.2V	25 ~ 49%	46.4 ~ 48.4V / 23.2 ~ 24.2V	50 ~ 74%	> 48.4V / > 24.2V	75 ~ 100%	Load < 50%	< 45.4 / 22.7V	0 ~ 24%	45.4 ~ 47.4V / 22.7 ~ 23.7V	25 ~ 49%	47.4 ~ 49.4V / 23.7 ~ 24.7V	50 ~ 74%	> 49.4V / > 24.7V	75 ~ 100%	
Load Percentage	Battery voltage (48 V model / 24 V model)	LCD screen																				
Load > 50%	< 44.4 / < 22.2V	0 ~ 24%																				
	44.4 ~ 46.4V / 22.2 ~ 23.2V	25 ~ 49%																				
	46.4 ~ 48.4V / 23.2 ~ 24.2V	50 ~ 74%																				
	> 48.4V / > 24.2V	75 ~ 100%																				
Load < 50%	< 45.4 / 22.7V	0 ~ 24%																				
	45.4 ~ 47.4V / 22.7 ~ 23.7V	25 ~ 49%																				
	47.4 ~ 49.4V / 23.7 ~ 24.7V	50 ~ 74%																				
	> 49.4V / > 24.7V	75 ~ 100%																				

Load Information	
	Indicates overload
	Indicates load level by 0 ~ 24%, 25 ~ 49%, 50 ~ 74% and 75 ~ 100% (left to right) increments.
Mode Operation Information	
	Constantly on: AC source valid Blinking: AC source present but rejected
	Constantly on: PV input valid Blinking: PV voltage detected, but not within allowed range
	Load supplied by AC input
	AC source charger circuit is active
	PV charger circuit is active
	DC to AC inverter circuit is active
	Alarm disabled
	BLE is ready to connect
	USB disk connected
	Timer setting or time display

8.4 Device Operation Settings

General Settings

Press  for 3 seconds to enter settings mode. Press  or  to select between settings menus. Once selected, press  to confirm the selection or  to exit without confirmation.

Settings menus

Menu no.	Description	Selectable Option and Notes
00	Exit setting mode	Escape 00 ESC





01	AC output source priority: Configure the priority of which power sources supply the AC output load	Utility / AC input first (Default) "USB" for: Utility → Solar → Battery 01 * USB	AC input / utility will provide power to the loads as first priority. If there is excess solar power beyond what is required for battery charging, this power is used to supply power to the loads instead. The battery is not discharged (Grid mode). Solar and battery will provide power to the loads when AC input / utility power is unavailable (Off-Grid mode).
		Solar / PV first "SUB" for: Solar → Utility → Battery 01 * SUB	Solar provides power to the loads as first priority. If solar power is not sufficient to power all connected loads, AC input / utility power will supply the loads simultaneously (Grid mode). If no solar power is available (ex. at night), AC input / utility power is used exclusively. The battery is only discharged when the AC input / utility power is unavailable (Off-Grid mode).
		SBU priority "SBU" for: Solar → Battery → Utility 01 * SBU	Solar powers the loads as first priority. If solar power is not sufficient to power all connected loads, the battery will supply power to the loads at the same time. The Any-Grid is disconnected from the grid at this time (Off-Grid mode). AC input / utility provides power to the loads (Grid mode) only when the battery voltage drops to either low-level warning voltage or the setting point in settings menu 12. When first applying SBU priority, it may take up to 10 minutes for the Any-Grid to switch to Off-Grid mode.
02	Maximum total battery charging current of AC and solar charging combined: Max. total charging current = AC input charging current + solar charging current This setting is important to limit charging current for some battery types.	10A 02 * 10	80A (Default) 02 * 80
		Can be set from 10 ~ 80 Adc (up to 120 Adc for PSW-H-6.5KW-120/48V and PSW-H-8KW-230/48V) in 10 Adc increments. This is the battery-side DC charging current.	
03	AC input voltage range	Appliances 03 * APL	Accepted AC input voltage range from 90 ~ 280 Vac for 230 Vac models, 80 ~ 140 Vac for 120 Vac models.

		UPS (Default) 03 UPS	Accepted AC input voltage range from 170 ~ 280 Vac for 230 Vac models, 90 ~ 140 Vac for 120 Vac models.
05	<p>Battery type</p> <p>Settings menus 26, 27 and 29 can only be modified if “User-defined” is selected here.</p> <p>Please visit www.phocos.com for a current list of (Lithium) batteries supported and their specific settings guides.</p> <p>CAUTION: Do not use inverter communication cables supplied with your batteries unless instructed by Phocos guides as this may damage the PSW-H and/or the battery!</p>	AGM (Default) 05 AGM	Flooded 05 FLD
		User-defined 05 USE	Battery charging voltages and low voltage disconnect (LVD) can be manually defined in settings menu 26, 27 and 29.
		Pylontech battery 05 PYL	For use with Pylontech Lithium batteries. Ensure the battery management system (BMS) communication is connected.
		WeCo battery 05 WEC	For use with WeCo Lithium batteries. Ensure the battery management system (BMS) communication is connected.
		BYD battery 05 BYD	For use with BYD Lithium batteries. Ensure the battery management system (BMS) communication is connected.
		RS-485 (MODBUS RTU) battery 05 RS4	For use with Lithium batteries using the Phocos MODBUS RTU communication protocol. Ensure the battery management system (BMS) communication is connected.
06	Automatic restart if an AC output overload occurs	Restart disabled (Default) 06 LFD	Restart enabled 06 LFE
07	Automatic restart when over-temperature occurs	Restart disabled (Default) 07 OTD	Restart enabled 07 OTE

08	<p>Solar power feed-in into grid</p> <p>A PIN code is required to change this setting. Grid feed-in / injection may not be legal at the site of installation. Contact your dealer for more details.</p> <p>Only activate when using the public grid as AC source, else your AC generator and the Any-Grid could be damaged.</p>	<p>Disabled (Default)</p> <p>08</p> <p>Grid</p>	<p>Enabled</p> <p>08</p> <p>Grid</p>
09	<p>AC output frequency</p> <p>Only relevant for Off-Grid mode</p>	<p>50 Hz (Default, 230 Vac models)</p> <p>09</p> <p>50_{Hz}</p>	<p>60 Hz (Default, 120 Vac models)</p> <p>09</p> <p>60_{Hz}</p>
10	<p>AC output voltage</p> <p>Only relevant for Off-Grid mode</p> <p>Note: To avoid damage, this value can only be changed if the inverter is in Stand-By mode (AC output turned off). See chapter “Installing Multiple Units in Parallel, Split Phase or 3-Phase Configuration” for detailed instructions.</p>	<p>230 Vac (Default, 230 Vac models)</p> <p>10</p> <p>230_V</p>	<p>From 220 ~ 240 Vac in 10 Vac increments for 230 Vac models.</p> <p>110, 120 and 127 Vac for 120 Vac models, default 120 Vac.</p>
11	<p>Maximum AC source charging current (battery side)</p> <p>If settings menu 02 is smaller than this value, charging will be limited by the value in settings menu 02.</p>	<p>30 Adc (Default)</p> <p>11</p> <p>30_A</p>	<p>Available values: 2 Adc and 10 ~ 80 Adc (up to 120 Adc for PSW-H-6.5KW-120/48V and PSW-H-8KW-230/48V) in 10 Adc increments.</p>
12	<p>Voltage set-point to switch from Off-Grid mode to Grid mode when “SBU priority” is selected in settings menu 01.</p> <p>This may be a percentage for some battery types selected in setting menu 05.</p>	<p>48 Vdc (48 Vdc model Default) 24 Vdc (24 Vdc model Default)</p> <p>12</p> <p>48_V</p>	<p>Available values: 44 ~ 57 Vdc in 1 Vdc increments for 48Vdc model.</p> <p>Available values: 22 ~ 28.5Vdc in 0.5 Vdc increments for 24Vdc model.</p>
13	<p>Voltage set-point to switch from Grid mode to Off-Grid mode when selecting “SBU priority” in settings menu 01.</p>	<p>Battery fully charged</p> <p>13</p> <p>FULL_V</p>	<p>54 Vdc (48 Vdc model Default) 27 Vdc (24 Vdc model Default)</p> <p>13</p> <p>54_V</p> <p>Available values: “FULL” and 48 ~ 64 Vdc in 1 Vdc increments for 48Vdc model.</p> <p>Available values: “FULL” and 24 ~ 32 Vdc in 1 Vdc increments for 24Vdc model.</p> <p>The battery is considered fully charged when the float charging phase is reached.</p>

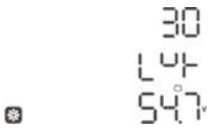
16	Battery charger source priority Configure the priority of which power sources are used to charge the battery. The AC source can only charge the battery if in Grid, Stand-By or Fault modes. In Off-grid mode only solar / PV power can charge the battery.	Solar first 16 ☼ C50	Solar power will charge battery as first priority. Utility will charge battery only when solar energy is not available and the unit is in Grid mode.
		Solar and Utility (Default) 16 ☼ SNU	Solar power and AC input power will charge battery at the same time if the unit is in Grid mode. While the AC output and PV are active, grid charging is temporarily disabled until either PV becomes unavailable or the AC output is no longer active.
		Only Solar 16 ☼ 050	Solar power will be the only battery charging source regardless of the operating mode.
18	General alarm control	Alarm on (Default) 18 ☼ 60N	Alarm off 18 ☼ 60F
19	Automatic return to default overview display screen	Return to default display view (Default) 19 ☼ ESP	The display will return to the default overview (input voltage / output voltage) if no button is pressed for approx. 1 minute.
		Remain at last view 19 ☼ FEP	The display will remain at the selected view indefinitely, until another view is selected.
20	Display backlight control	Backlight always on (Default) 20 ☼ LON	Backlight off after one minute of no button presses 20 ☼ LOF
22	Beeps while primary source is interrupted	Alarm on (Default) 22 ☼ AON	Alarm off 22 ☼ AOF
23	Overload by-pass: When enabled, the unit will quickly switch to Grid mode if an AC output overload occurs in Off-Grid mode. It will return to Off-Grid mode once the load power has normalized.	By-pass disabled (Default) 23 ☼ byd	By-pass enabled 23 ☼ byE

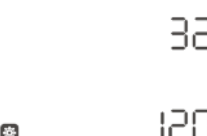
25	Record fault codes to internal datalogger	Record enabled (Default) 25 FEN	Record disabled 25 Fds
26	Boost battery charging voltage	57.6 Vdc (48 Vdc model Default) 28.8 Vdc (24 Vdc model Default) 26 Cu 57.6v	If "User-defined" is selected in settings menu 05, this value can be changed. Available values: 48.0 ~ 64.0Vdc in 0.1 Vdc increments for 48 Vdc model. Available values: 24.0 ~ 32.0Vdc in 0.1 Vdc increments for 24 Vdc model.
27	Floating battery charging voltage	55.2 Vdc (48 Vdc model Default) 27.6 Vdc (24 Vdc model Default) 27 FLd 55.2v	If "User-defined" is selected in settings menu 05, this value can be changed. Available values: 48.0 ~ 64.0Vdc in 0.1 Vdc increments for 48 Vdc model. Available values: 24.0 ~ 32.0Vdc in 0.1 Vdc increments for 24 Vdc model.
28	AC output mode Note: To avoid damage, this value can only be changed if the inverter is in Stand-By mode (AC output turned off). See chapter "Installing Multiple Units in Parallel, Split Phase or 3-Phase Configuration" for detailed instructions. Split-phase / 2-phase modes are only available on 120 Vac models.	Single: This unit is used alone in a single-phase application (Default) 28 S1 0	Parallel: This unit is one of several units in a single-phase application 28 PAR
		Phase L1: This unit is one of several units and on phase 1 in a three-phase application 28 3P 1	Phase L2: This unit is one of several units and on phase 2 in a three-phase application 28 3P 2
		Phase L3: This unit is one of several units and on phase 3 in a three-phase application 28 3P 3	Phase L1: This unit is one of several units and on phase 1 in a split-phase (2-phase) application 28 2P 1
		Phase L2: This unit is one of several units and on phase 2 in a split-phase (2-phase) application, with 120° phase-shift relative to phase 1: 28 120 2P 2	Phase L2: This unit is one of several units and on phase 2 in a split-phase (2-phase) application, with 180° phase-shift relative to phase 1: 28 180 2P 2

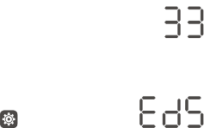
29	<p>Low voltage disconnect</p> <p>The AC output is turned off when the battery reaches this voltage level to protect the battery from deep discharge. The low DC / battery warning voltage is 2 Vdc for the 48V model and 1 Vdc for the 24V model above this setting.</p> <p>Note: It is necessary for each unit to have a PV array or AC source connected to wake up after a low voltage disconnect event.</p>	<p>44.0 Vdc (48 Vdc model Default) 22.0 Vdc (24 Vdc model Default)</p> 	<p>If "User-defined" is selected in settings menu 05, this value can be changed.</p> <p>Available values: 37.5 ~ 54.0Vdc in 0.1 Vdc increments for 48 Vdc model.</p> <p>Available values: 18.8 ~ 27.0Vdc in 0.1 Vdc increments for 24 Vdc model.</p> <p>This voltage is fixed and independent of the load power level.</p>
30	<p>Low voltage reconnect</p> <p>If the AC output is turned off due to low voltage disconnect (settings menu 29), the AC output is automatically turned back on once this voltage is reached. This value must be at most 0.5 Vdc below settings menu 27, and at least 4 Vdc for the 48 V model or 2 Vdc for the 24 V model higher than settings menu 29.</p> <p>Note: It is necessary for each unit to have a PV array or AC source connected for low voltage reconnect to function.</p>	<p>54.7 Vdc (48 Vdc model Default) 27.1 Vdc (24 Vdc model Default)</p> 	<p>If "User-defined" is selected in settings menu 05, this value can be changed.</p> <p>Available values: 41.6 ~ 63.5Vdc in 0.1 Vdc increments for 48 Vdc model.</p> <p>Available values: 20.9 ~ 31.5Vdc in 0.1 Vdc increments for 24 Vdc model.</p>
32	<p>Boost battery charging duration</p> <p>The duration for which the boost voltage from settings menu 26 is held before the Floating phase is reached.</p>	<p>Automatic</p> 	<p>120 min (Default)</p>  <p>If "User-defined" is selected in settings menu 05, this value can be changed. Available values: "Automatic" and 5 ~ 900 minutes in 5 min. increments.</p> <p>If "Automatic" is set, the duration of bulk phase (see chapter "Specifications" → "Battery Charging") is multiplied by 10, with a minimum of 10 minutes and maximum of 8 hours.</p>
33	<p>Battery equalization</p> <p>Battery equalization helps prevent sulfation of lead-acid batteries and is beneficial for bringing all cells to the same voltage. Consult your battery manual to make sure the battery can withstand the higher voltages required for this purpose. This is typically the case for flooded lead-acid batteries.</p>	<p>Enabled</p> 	<p>Disabled (Default)</p>  <p>If "User-defined" or "Flooded" is selected in settings menu 05, this value can be changed.</p>

34	Battery equalization voltage	59.2 Vdc (48 Vdc model Default) 29.6 Vdc (24 Vdc model Default) 34 E _Q 59.2 ⊗	Available values: 48.0 ~ 64.0Vdc in 0.1 Vdc increments for 48 Vdc model. Available values: 24.0 ~ 32.0Vdc in 0.1 Vdc increments for 24 Vdc model.
35	Battery equalization duration The duration for which the equalization voltage from settings menu 34 is held before the Floating phase is reached.	120 min. (Default) 35 120 ⊗	Available values: 5 ~ 900 minutes in 5 min. increments.
36	Battery equalization timeout If the equalization voltage from settings menu 34 cannot be reached within the duration from settings menu 35, once this timeout is reached, equalization is ended and the charger returns to Floating phase.	180 min. (Default) 36 180 ⊗	Available values: 5 ~ 900 minutes in 5 min. increments.
37	Equalization interval	30 days (Default) 37 30d ⊗	Available values: 0 ~ 90 days in 1-day increments.
39	Equalization phase: forced start	Enabled 39 AEN ⊗	Disabled (Default) 39 AdS ⊗
		If the battery equalization function is enabled in settings menu 33, this function can be enabled. If "Enabled" is selected in this menu, battery equalization is immediately force-started and the display main view will show E _Q (EQ). If "Disabled" is selected, it will cancel the forced equalization function until the next scheduled equalization interval as defined in settings menu 37. E _Q will no longer be shown in LCD main page.	
40	Reset PV and Load energy datalogger storage	Not reset (Default) 40 nrt ⊗	Reset 40 rst ⊗

41	Maximum discharging current This setting is important to limit discharging current for some battery types.	Disabled (Default) 41 ⊗ dds	120 A 41 ⊗ 120
		<p>Depending on the battery type used, its maximum discharge current may be lower than what the Any-Grid unit requires to deliver its full power to AC loads. If set to “Disabled” the unit will draw as much current from the battery as necessary to supply the loads. If overloaded by too much load power, settings menu 23 determines if the unit may switch to the AC input by-pass to deliver more power or protect itself by turning off permanently (until manual restart) or temporarily (depends on settings menu 06).</p> <p>If this setting is not “Disabled” then the unit will allow a maximum of the set discharge current. If this limit is surpassed for more than 5 minutes, the unit will switch to the AC input by-pass temporarily to provide more power to the loads. If no AC source is available, then the unit will shut down for several seconds. After multiple failed attempts the unit will turn off without reattempting to start the loads again.</p> <p>Available values: Disabled and 30 ~ 120 Adc (up to 150 Adc for PSW-H-8KW-230/48V) in 10 Adc increments for 48Vdc model.</p> <p>Available values: Disabled and 30 ~ 150 Adc in 10 Adc increments for 24Vdc model.</p>	
93	Erase all datalogger contents	No reset (Default) 93 ⊗ nrt	Reset 93 ⊗ rst
94	Datalogger storage period	10 days (Default) 94 ⊗ 10	<p>The Any-Grid unit can store measurement data with the following frequency:</p> <p>3 days: 20 entries per hour 5 days: 12 entries per hour 10 days: 6 entries per hour 20 days: 3 entries per hour 30 days: 2 entries per hour 60 days: 1 entry per hour</p> <p>Once the memory is full, the oldest entries are over-written.</p> <p>Available values: 3, 5, 10, 20, 30 and 60 days.</p> <p>Irrespective of this setting the unit stores the last 100 error / warning event codes.</p>
95	Time setting: minute	95 n1 n ⊗ 00	<p>Allows setting the current time in minutes.</p> <p>Available values: 00 ~ 59 minutes.</p>
96	Time setting: hour	96 HOu ⊗ 00	<p>Allows setting the current time in hours (24h notation).</p> <p>Available values: 00 ~ 23 hours.</p>

97	Date setting: day of month		Allows setting the current day of the month. Available values: day 01 ~ 31.
98	Date setting: month		Allows setting the current month. Available values: month 01 ~ 12.
99	Date setting: year		Allows setting the current year (last two digits: ex. 2019 = 19). Available values: year 17 ~ 99.

8.5 USB and Timer Settings

There are three function keys on the display module to implement functions such as USB OTG, timer settings for the output source priority and timer settings for the battery charger source priority.

USB Functionality

Insert a USB OTG storage device (disk) or a USB disk with a USB OTG microUSB adaptor (Micro-B male to USB Type A female, sold separately) into the USB port (see **Fig. 2**). Press for 3 seconds to enter USB function mode. These functions are described in the table below.

Note: If no button is pressed within 1 minute of starting this procedure, the screen it will automatically return to the default main view.

Follow these steps to select the various USB functions:

1. Press for 3 seconds to enter USB function mode:

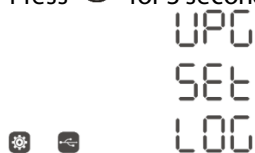

2. Press to enter the following settings program:

Function	Description	Screen View
Export data log	1. By pressing the unit prepares to export the internal data log to a connected USB disk. Once the function is ready, the screen will display . Press the button to confirm the selection.	
	2. Press to select "YES" or to return to the main screen without any change. 3. If "YES" was selected, Source LED 1 (see Fig. 19) will flash once every second during the process. 4. Once the data log copy to the USB disk is complete, the screen will show: and all LEDs will be lit. 5. Now press to return to main screen. Otherwise, it will return to the main view automatically after 1 minute.	

Possible error messages for USB functions:

Error Code	Description
U01	No USB disk is detected
U02	USB disk is write-protected
U03	File from USB disk has incorrect format or USB stick is incompatible

If any error occurs, the error code will be displayed for three seconds. After three seconds, the screen returns to the default main view.

Timer Override Setting for AC Output Source Priority





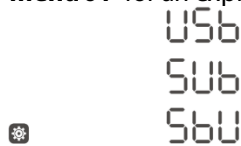

This timer setting is to set up the daily AC output source priority.

Note: If no button is pressed within 1 minute of starting this procedure, the screen will automatically return to the default main view.

To define a daily time period in which a specific AC output source priority is to be temporarily activated, follow the steps below:







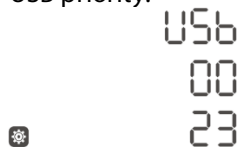

1. Press and hold  for 3 seconds to enter the timer setting for the AC output source priority. The three available priority orders are shown on the display (see chapter “Device Operation Settings” → “Settings menu 01” for an explanation):



2. From top to bottom the priorities shown in the screen represent:
 - a. Utility / AC input first (“USB” for Utility → Solar → Battery)
 - b. Solar / PV first (“SUB” for Solar → Utility → Battery)
 - c. SBU priority (“SBU” for Solar → Battery → Utility)
3. Press either ,  or  to enter one of the three selectable priorities:
 - a.  = USB
 - b.  = SUB
 - c.  = SBU

4. The selected priority order (USB, SUB or SBU) is shown at the top of the screen. The middle shows the starting time and the bottom shows the stopping time in full hours (24h notation). As an example for the USB priority:



5. Press  to select the starting time (middle of screen), it will flash. Now press  or  to change the starting time in 1-hour steps. Then, press  to confirm the starting time, it will stop flashing.
6. Press  to select the ending time (bottom of screen), it will flash. Now press  or  to change the ending time in 1-hour steps. Then, press  to confirm the ending time, it will stop flashing.
7. Now press  to return to main screen.

Timer Override Setting for Battery Charger Source Priority

This timer setting is to set up the daily battery charger source priority.

Note: If no button is pressed within 1 minute of starting this procedure, the screen it will automatically return to the default main view.

To define a daily time period in which a specific battery charging source priority is to be temporarily activated, follow the steps below:

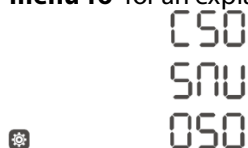

1. Press and hold  for 3 seconds to enter the timer setting for the battery charger source priority. The three available priority orders are shown on the display (see chapter "Device Operation Settings" → "Settings menu 16" for an explanation):



2. From top to bottom the priorities shown in the screen represent:







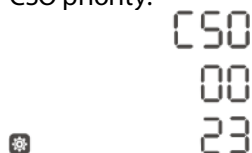

- a. Solar first ("CSO" for Charger Solar)
- b. Solar and Utility ("SNU" for Solar and Utility)
- c. Only Solar ("OSO")

3. Press either ,  or  to enter one of the three selectable priorities:



- a.  = CSO
- b.  = SNU
- c.  = OSO

4. The selected priority order (CSO, SNU or OSO) is shown at the top of the screen. The middle shows the starting time and the bottom shows the stopping time in full hours (24h notation). As an example for the CSO priority:



5. Press  to select the starting time (middle of screen), it will flash. Now press  or  to change the starting time in 1-hour steps. Then, press  to confirm the starting time, it will stop flashing.
6. Press  to select the ending time (bottom of screen), it will flash. Now press  or  to change the ending time in 1-hour steps. Then, press  to confirm the ending time, it will stop flashing.
7. Now press  to return to main screen.

8.6 Screen Views of Current Values

The screen views can be scrolled by pressing  or  to show current values in the following order:

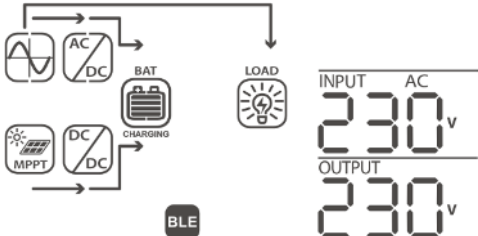
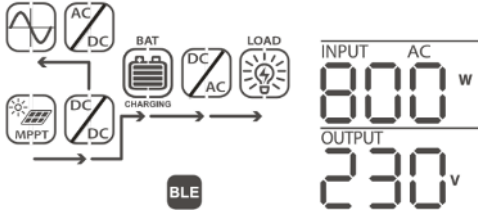
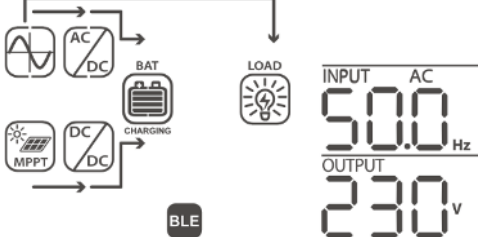
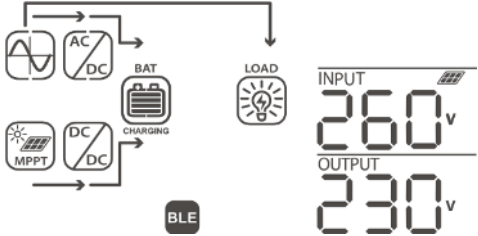
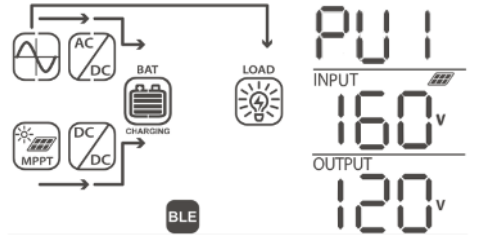
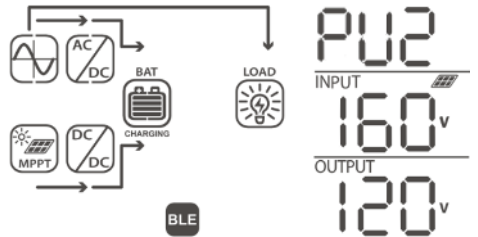
Measurement Values	Screen View Example
<p>AC input voltage / AC output voltage (Default Display Screen)</p>	<p>If there is no grid feed-in: Input voltage = 230 Vac, Output voltage = 230 Vac</p>  <p>If there is grid feed-in: Feed-in power = 800 W, Output voltage = 230Vac</p> 
<p>AC input frequency</p>	<p>Input frequency = 50 Hz, Output voltage = 230 Vac</p> 
<p>PV voltage</p>	<p>PV voltage = 260 Vdc</p>  <p>PV1 voltage (only PSW-H-5KW-120/48V, PSW-H-6.5KW-120/48V and PSW-H-8KW-230/48V) = 160 Vdc</p>  <p>PV2 voltage (only PSW-H-5KW-120/48V, PSW-H-6.5KW-120/48V and PSW-H-8KW-230/48V) = 160 Vdc</p> 

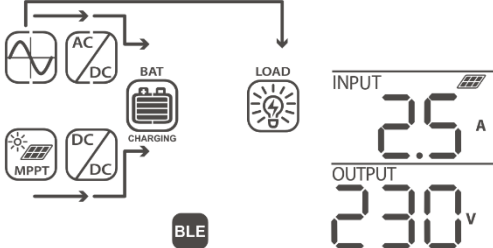
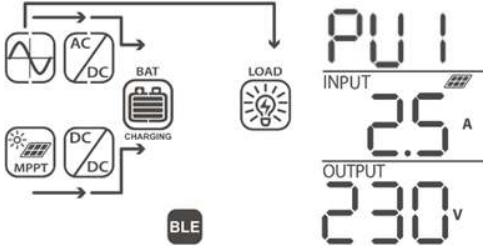
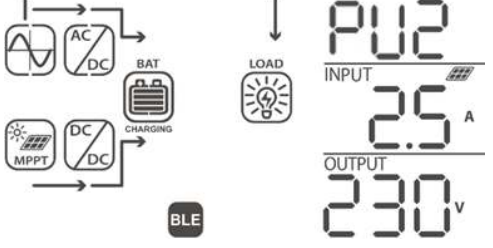
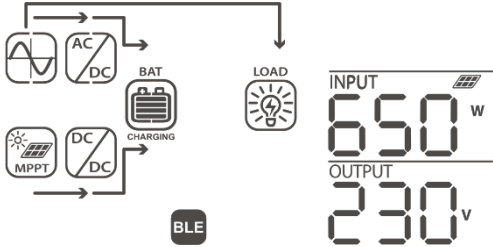
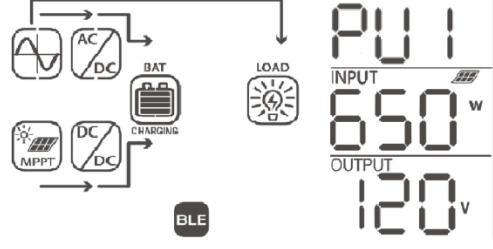
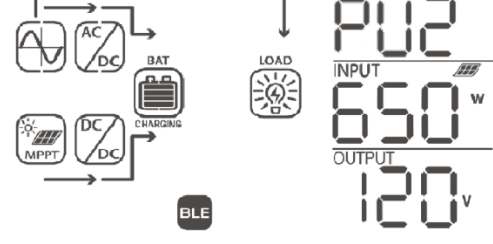
<p>PV current</p>	<p>PV current = 2.5 Acd</p>  <p>PV1 current (only PSW-H-5KW-120/48V, PSW-H-6.5KW-120/48V and PSW-H-8KW-230/48V) = 2.5 Acd</p>  <p>PV2 current (only PSW-H-5KW-120/48V, PSW-H-6.5KW-120/48V and PSW-H-8KW-230/48V) = 2.5 Acd</p> 
<p>PV power</p>	<p>PV power = 650 W</p>  <p>PV1 power (only PSW-H-5KW-120/48V, PSW-H-6.5KW-120/48V and PSW-H-8KW-230/48V) = 650 W</p>  <p>PV2 power (only PSW-H-5KW-120/48V, PSW-H-6.5KW-120/48V and PSW-H-8KW-230/48V) = 650 W</p> 

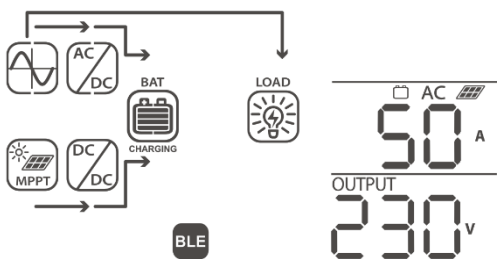
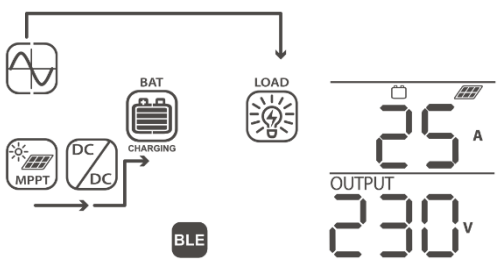
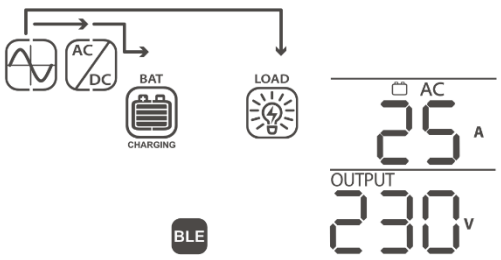
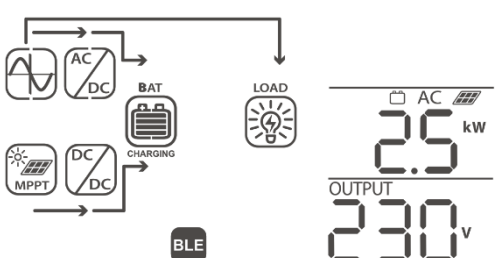
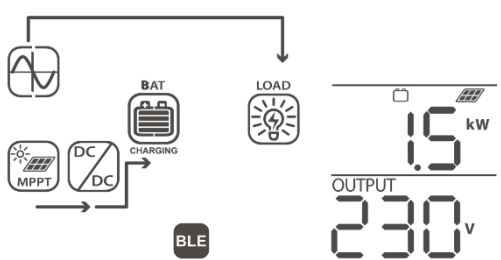
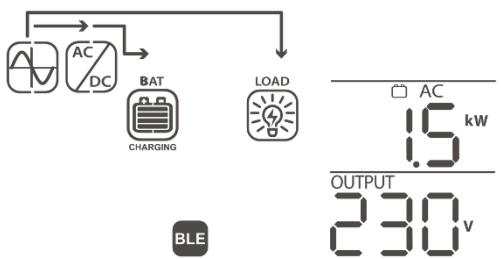
<p>Charging current</p>	<p>AC and PV charging current (battery side) = 50 Adc</p>  <p>PV charging current = 25 Adc</p>  <p>AC charging current = 25 Adc</p> 
<p>Charging power</p>	<p>AC and PV charging power = 2.5 kW</p>  <p>PV charging power = 1.5 kW</p>  <p>AC charging power = 1.5 kW</p> 

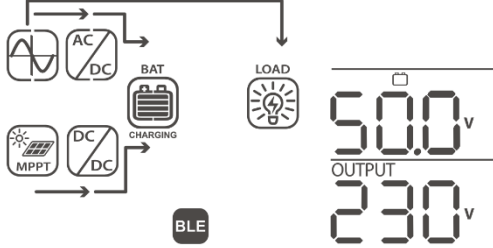
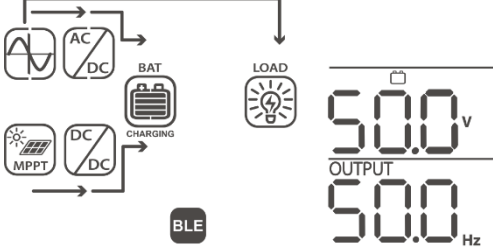
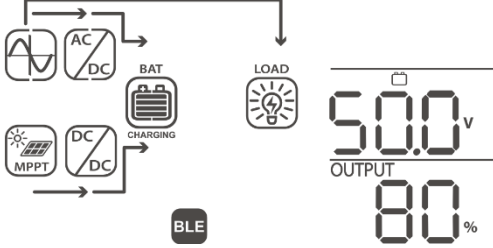
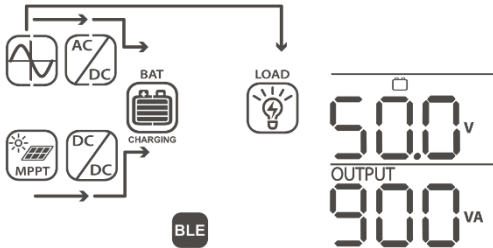
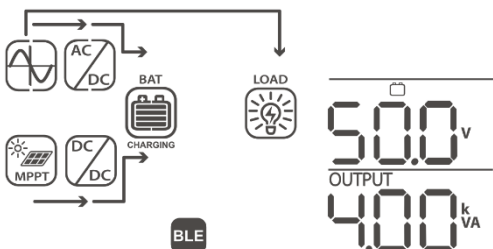

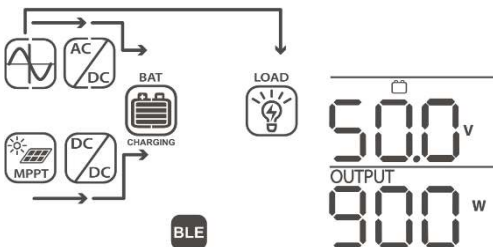
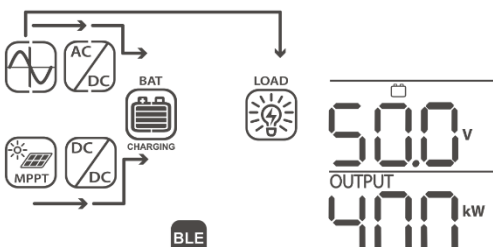
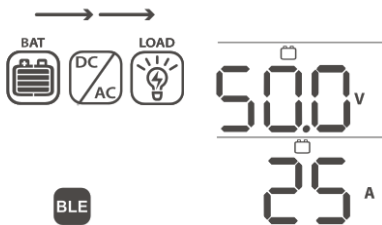
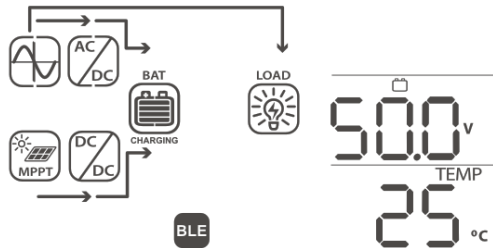
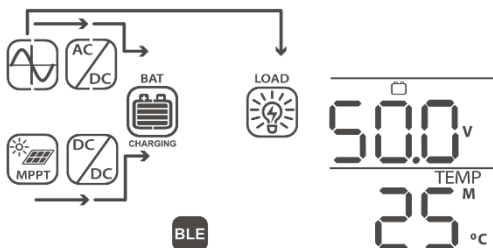
<p>Battery voltage and AC output voltage</p>	<p>Battery voltage = 50 Vdc, output voltage = 230Vac</p> 
<p>AC output frequency</p>	<p>Output frequency = 50 Hz</p> 
<p>AC output percentage of nominal inverter power</p>	<p>Load percent = 80%</p> 
<p>AC output in VA (apparent power)</p>	<p>When load power is lower than 1 kVA, apparent power is shown in VA (ex. 900 VA)</p>  <p>When load power is higher than 1 kVA, apparent power is shown in kVA (ex. 4.00 kVA)</p> 

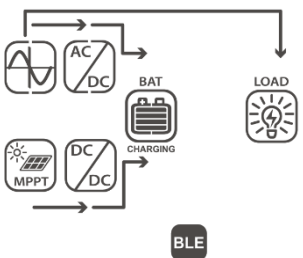
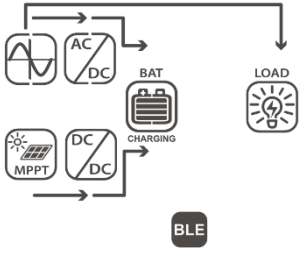
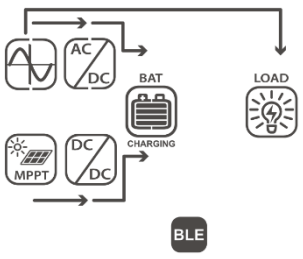
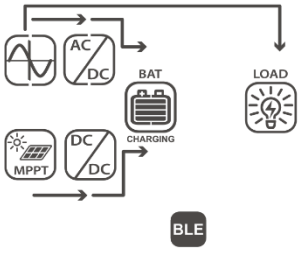
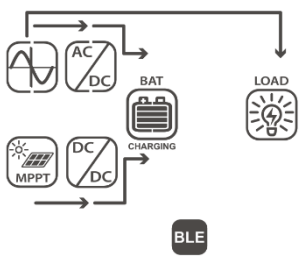

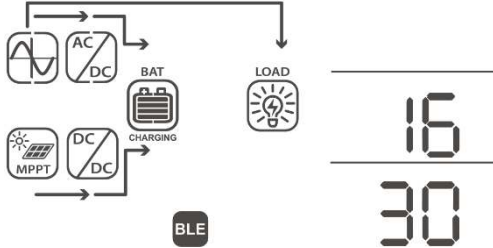
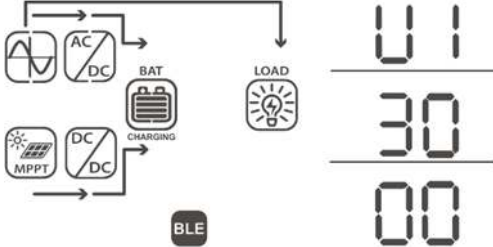
<p>Load in Watt (active power)</p>	<p>When load power is lower than 1 kW, active power is shown in W (ex. 900 W)</p>  <p>When load power is higher than 1 kW, active power is shown in kW (ex. 4.00 kW)</p> 
<p>Battery voltage / DC discharging current</p>	<p>Battery voltage = 50 Vdc, discharging current = 25 Adc</p> 
<p>Battery voltage / inverter internal temperature and solar charge controller internal temperature (Inverter temperature and solar charge controller temperature is displayed in turns)</p>	<p>Battery voltage = 50 Vdc, inverter temperature = 25 °C</p>  <p>Battery voltage = 50 Vdc, solar charge controller temperature = 25 °C</p> 

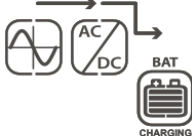
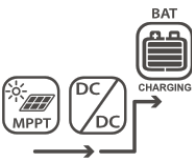
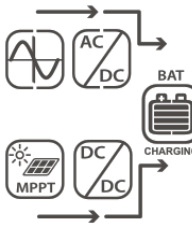

<p>PV energy generated today, and AC output energy consumed today</p>	<p>PV energy = 2.38 kWh, AC output energy = 2.38 kWh</p>  <p>DAY INPUT 2.38 kWh OUTPUT 2.38 kWh</p>
<p>PV energy generated this month, and AC output energy consumed this month</p>	<p>PV energy = 23.8 kWh, AC output energy = 23.8 kWh</p>  <p>MONTH INPUT 23.8 kWh OUTPUT 23.8 kWh</p>
<p>PV energy generated this year, and AC output energy consumed this year</p>	<p>PV energy = 2.38 MWh, AC output energy = 2.38 MWh</p>  <p>YEAR INPUT 2.38 MWh OUTPUT 2.38 MWh</p>
<p>PV energy generated in total, and AC output energy consumed in total</p>	<p>PV energy = 23.8 MWh, AC output energy = 23.8 MWh</p>  <p>TOTAL INPUT 23.8 MWh OUTPUT 23.8 MWh</p>
<p>Current date</p>	<p>October 28, 2019</p>  <p>19 10 28</p>

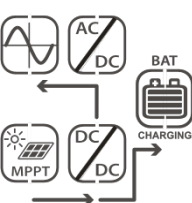
<p>Current time (24h notation)</p>	<p>16:30 hrs.</p> 
<p>3 consecutive views are available:</p> <ul style="list-style-type: none"> • Main unit firmware version (U1) • Display unit firmware version (U2) • BLE controller version (U3) 	<p>U1 firmware version 30.00</p> 

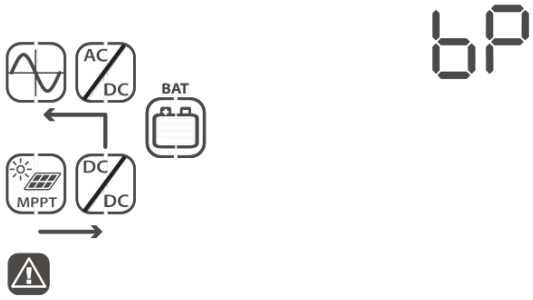
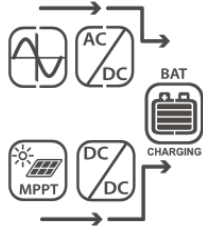
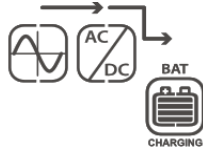
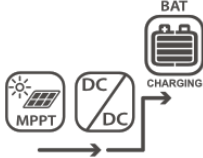
8.7 Operating Mode Description

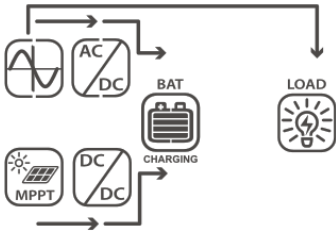
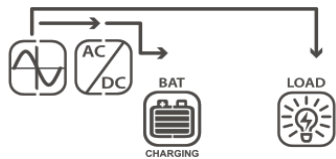
Operating mode	Behaviors	LCD display
<p>Stand-By mode</p> <p>The AC output is not turned on, but the unit can charge the battery without AC output (if the inverter ON/OFF switch is set to the OFF position).</p>	<p>No AC output voltage is supplied by the unit, but it still can charge batteries</p>	<p>Battery is charged by an AC source</p> 
		<p>Battery is charged by solar power</p> 
		<p>Battery is charged by AC source and solar power</p> 
		<p>No charging</p> 
		<p>Battery is charged by solar power and excess power is fed into the grid</p> 

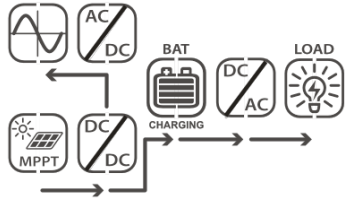
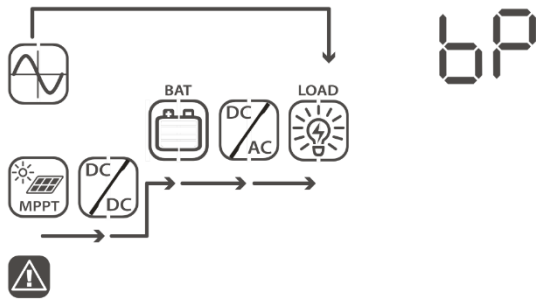
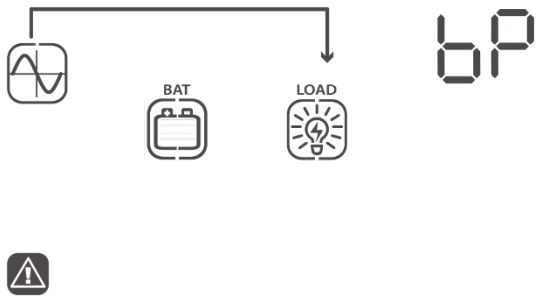
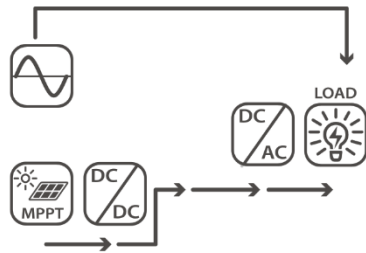
		<p>No battery connected, solar power is fed directly into the grid</p> 
<p>Fault mode</p> <p>Errors are currently active (see chapter "Fault Reference Codes" for details)</p>	<p>Solar power and AC source can charge batteries</p>	<p>Battery is charged by AC source and solar power</p> 
		<p>Battery is charged by an AC source</p> 
		<p>Battery is charged by solar power</p> 
		<p>No charging</p> 
<p>Grid mode</p>	<p>AC output can be powered from the AC input, battery charging is available</p>	<p>Battery is charged and AC loads are powered by AC source</p> 
		<p>Battery is charged and AC loads are powered by an AC source</p> 

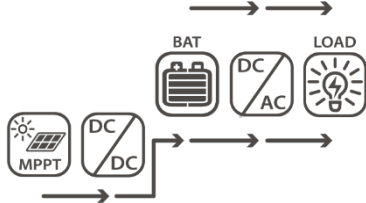
		<p>Battery is charged and AC loads are powered by the grid and excess power is fed into the grid</p> 
		<p>No battery connected, solar power and AC source provide power to AC loads</p> 
		<p>No battery connected, AC source provides power to AC loads</p> 
<p>Battery-free mode No battery is connected to the Any-Grid</p>	<p>AC output power is fully sourced from the AC input and solar power</p>	<p>Solar power and the AC source provide power to the AC output</p> 
		<p>AC source provides power to the AC output</p> 
<p>Off-Grid mode</p>	<p>AC output power from battery (if connected) and solar power</p>	<p>Battery and solar provide power to the AC output</p> 

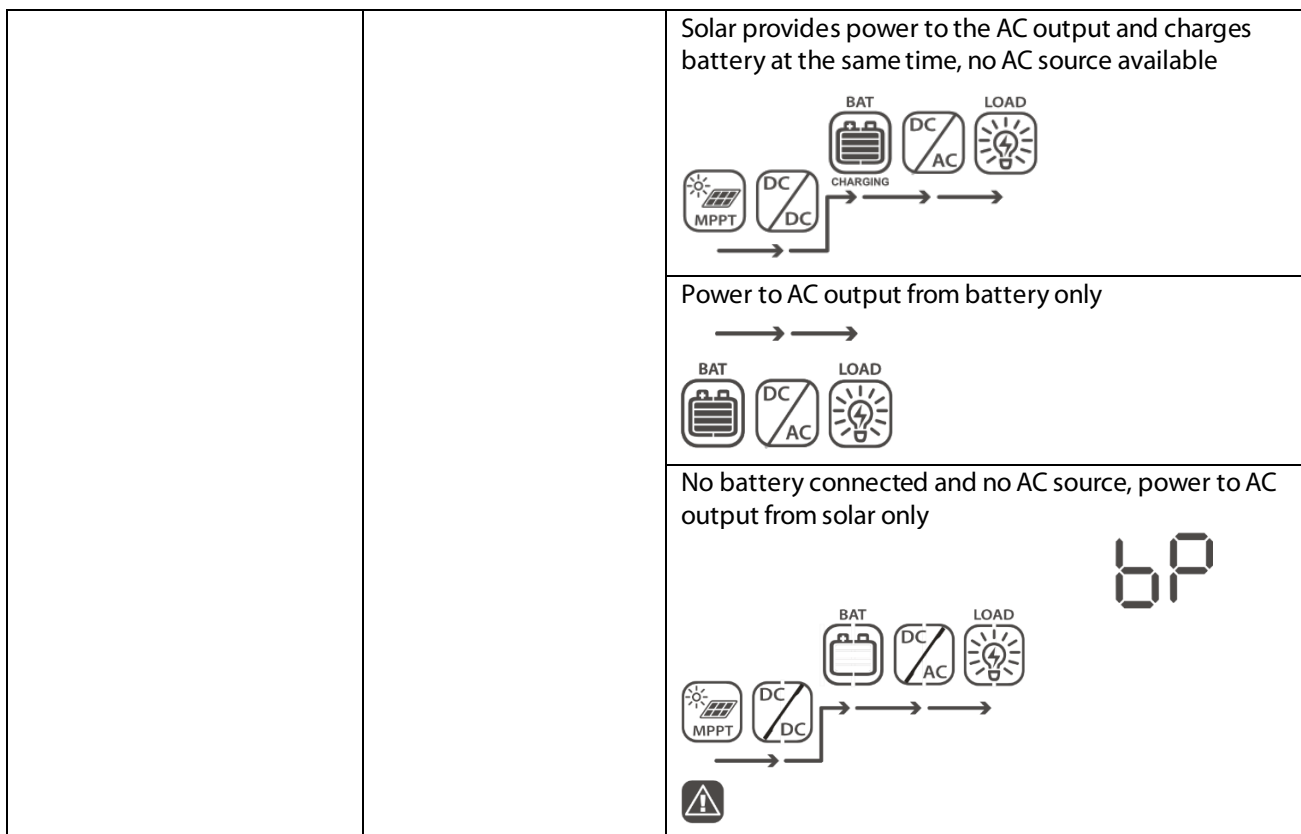





9.0 Fault Reference Codes

Fault Code	Fault Event	Screen View
01	Fan is locked while inverter is off	F01
02	Over-temperature	F02
03	Battery voltage is too high	F03
04	Battery voltage is too low	F04
05	AC output is short circuited	F05
06	AC output voltage is too high	F06
07	AC output overload timeout	F07
08	Internal DC bus voltage is too high	F08
09	Internal DC bus soft start failed	F09
10	Solar charge controller over-current	F10
11	Solar charge controller over-voltage	F11
12	DC-DC converter over-current	F12
13	Battery discharge over-current	F13
51	Inverter over-current	F51
52	Internal DC bus voltage is too low	F52

53	Inverter soft-start failed	F53
55	DC voltage component in AC output too high	F55
57	Current sensor failed	F57
58	Output voltage too low	F58
60	Power feedback protection	F60
71	Firmware version inconsistent	F71
72	Current sharing fault	F72
80	CAN communication fault	F80
81	Host unit loss	F81
82	Synchronization loss	F82
83	Battery voltage detected differs between units	F83
84	AC input voltage and frequency detected differs between units	F84
85	AC output current unbalanced	F85
86	AC output mode setting differs between units	F86
90	EEPROM corrupted	F90

10.0 Warning Codes

Warning Code	Warning Event	Audible Alarm	Screen view
01	Fan is locked while inverter is on	Beeps three times every second	01 
02	Over-temperature	None	02 
03	Battery is over-charged	Beeps once every second	03 
04	Low battery voltage	Beeps once every second	04 

07	AC output overload	Beeps twice every second	  07
10	AC output power de-rating	Beeps twice every 3 seconds	 10
32	Communication interrupted between main inverter unit and remote display panel.	None	 32
60 Only available if Lithium battery communication is active.	Battery charging and discharging temporarily disabled to protect Lithium battery.	Beeps once every second	 60
61 Only available if Lithium battery communication is active.	Battery communication lost. After 10 minutes of no communication charging and discharging will stop to protect Lithium battery.	Beeps once every second	 61
62 Only available if Lithium battery communication is active.	Communication between batteries is interrupted.	Beeps once every second	 62
69 Only available if Lithium battery communication is active.	Battery charging temporarily disabled to protect Lithium battery.	Beeps once every second	 69
70 Only available if Lithium battery communication is active.	Battery discharging temporarily disabled to protect Lithium battery.	Beeps once every second	 70
Eq	Battery equalization	None	 Ɛ9
bP	Battery is not connected	None	  bP

Informational codes regarding use of systems with multiple Any-Grid units:

Code	Description	Screen view
NE	Unidentified Host or Client unit	NE
HS	Host unit	HS
SL	Client unit	SL

11.0 Troubleshooting

Problem	LCD / LED / Buzzer	Explanation / Possible cause	What to do
Unit shuts down automatically during start-up process.	LCD / LEDs and buzzer will be active for 3 seconds and then turn off.	The battery voltage is too low (< 45.84V / < 22.92V for the 48V / 24V model)	1. Re-charge battery 2. Replace battery
No response after power on.	No indication.	1. The battery voltage is far too low (< 33.6V / < 16.8V for the 48V / 24V model) 2. Battery polarity is connected in reverse	1. Check if batteries and the wiring are connected correctly, check battery polarity. 2. Re-charge battery. 3. Replace battery.
AC source exists but the unit works in Off-Grid / battery mode.	AC input voltage displayed as 0 on LCD, green LED flashing.	Input circuit breaker is tripped	Check if AC circuit breaker is tripped and AC wiring is connected correctly.
	Green LED is flashing.	Insufficient quality of AC power (Grid or Generator)	1. Check if AC wires are too thin and/or too long. 2. Check if generator (if applied) is working correctly or if input voltage range setting is correct (try switching from UPS mode → Appliances mode), see chapter "Device Operation Settings" → "Settings menu 03" for details.
	Green LED is flashing.	"Solar / PV First" is set as the priority of the AC output source.	Change output source priority to "AC input / utility first", see chapter "Device Operation Settings" → "Settings menu 01" for details.
When the unit is turned on, internal relay is switched on and off repeatedly.	LCD and LEDs are flashing	Battery is disconnected.	Check if battery wires are well connected.

Buzzer beeps continuously and red LED is on.	Fault code 07	Overload error. Inverter is overloaded $\geq 110\%$ for more than allowed duration.	Reduce the connected load by switching off some equipment.
	Fault code 05	Output short circuited.	Check if wiring is connected well and remove abnormal loads.
		Temperature of internal converter components is over 120°C.	Check whether the air flow of the unit is blocked or whether the ambient temperature is too high.
	Fault code 02	Temperature of inverter components is over 100°C.	
	Fault code 03	Battery is over-charged.	Return to repair center.
		The battery voltage is too high.	Check if specifications and quantity of batteries meet requirements.
	Fault code 01	Fan fault	Replace the fan(s)
	Fault code 06/58	AC output abnormal	1. Reduce the connected load. 2. Return to repair center
	Fault code 08/09/53/57	Internal components failed.	Return to repair center.
	Fault code 51	Over current or surge.	Restart the unit, if the error occurs again, please return to repair center.
	Fault code 52	Internal DC bus voltage too low.	
	Fault code 55	Output voltage unbalanced.	
	Fault code 56	Battery not connected correctly / internal fuse blown.	If the battery is connected correctly, please return to repair center.
	Fault code 13	Battery discharge over-current detected.	Increase the battery discharge current limit in settings menu number 41.
	Warning code 60	Battery discharging and charging temporarily disabled by battery management system.	Battery is not allowed to discharge and charge as the battery management system (BMS) in the connected battery has blocked discharging and charging due a BMS error. The Any-Grid will stop discharging and charging the battery.
	Warning code 61	Battery management system communication loss.	This fault is only available when the battery type in settings menu 05 is set to anything other than "AGM", "Flooded" or "User-defined". Unless you are using a BMS connection for a compatible lithium battery and have correctly configured the connection, make sure to use "AGM", "Flooded" or "User-defined" in settings menu 05. After battery communication cable is connected and a communication signal is not detected for 3 minutes, buzzer will beep. After 10 minutes, inverter will stop charging and discharging the battery.

	Warning code 69	Battery charging temporarily disabled by battery management system.	Battery is not allowed to charge as the battery management system (BMS) in the connected battery has blocked charging due a BMS or battery cell error.The Any-Grid will stop charging the battery.
	Warning code 70	Battery discharging temporarily disabled by battery management system.	Battery is not allowed to discharge as the battery management system (BMS) in the connected battery has blocked discharging due a BMS or battery cell error.The Any-Grid will stop discharging the battery.
	Fault code 71	The firmware version of each inverter is not the same.	<ol style="list-style-type: none"> 1. Check the version of each inverter firmware via the screen and make sure the versions are same. If not, contact your instraller to provide a firmware update. 2. After updating, if the problem still remains, please contact your repair center.
	Fault code 72	The output current of each inverter is different.	<ol style="list-style-type: none"> 1. Check if the green current sharing cables are correctly connected and restart the unit. 2. If the problem remains, please contact your repair center.
	Fault code 80	CAN communication data loss	<ol style="list-style-type: none"> 1. Check if the grey communication cables are correctly connected between all units and restart the units. 2. If the problem remains, please contact your repair center.
	Fault code 81	Host data loss	
	Fault code 82	Synchronization data loss	
	Fault code 83	The detected battery voltage differs between units.	<ol style="list-style-type: none"> 1. Make sure all inverters share same battery bank. 2. Remove all loads and disconnect AC input and PV input. Then, check the battery voltage of all units. If the values from all inverters are close, please check if all battery cables are the same length and same material and cross-section. Verify the seat of each battery connection to the respective units. 3. If the problem still remains, please contact your repair center.

	Fault code 84	The detected AC input voltage and frequency differ between units.	<ol style="list-style-type: none"> 1. Check the AC input wiring connection and restart the unit. 2. Make sure the AC source starts up with the same voltage and frequency on each phase. If there are breakers installed between AC inout and Any-Grid units, please be sure all breakers can be turned on the AC input at same time. 3. If the problem still remains, please contact your repair center.
	Fault code 85	AC output current unbalanced	<ol style="list-style-type: none"> 1. Restart the inverter. 2. Remove excessive loads and re-check load information from LCD of units. If the values are different between units on the same phase, please check if AC input and output cables are the same length, cross-section and material. 3. If the problem remains, please contact your repair center.
	Fault code 86	AC output mode setting is different between units.	<ol style="list-style-type: none"> 1. Switch off the units and check settings menu number 28. 2. For parallel systems on a single phase, make sure each unit is set to "PAL" in settings menu number 28. For split-phase and 3-phase systems, make sure each unit has the same two first characters in settings menu number 28 ("2P" for split-phase "3P" for 3-phase) and is on the correct phase. 3. If the problem remains, please contact your repair center.
	Fault code 90	EEPROM corrupted	Please contact your repair center and communicate the serial number of the affected unit.

12.0 Specifications

12.1 Grid Mode

Model	PSW-H-8KW-230/48V	PSW-H-5KW-230/48V	PSW-H-3KW-230/24V	PSW-H-5KW-120/48V PSW-H-6.5KW-120/48V	PSW-H-3KW-120/24V
AC Input Voltage Waveform	Pure Sine Wave (utility or generator)				
Nominal AC Input Voltage	230 Vac			120 Vac	
Maximum AC Input Current	60 Aac	40 Aac	30 Aac	60 Aac	38.3 Aac

AC Input Overvoltage Category	OVC III					
Low Loss AC Input Voltage	170 Vac ± 7 Vac (UPS mode) 90 Vac ± 7 Vac (Appliances mode) See chapter "Device Operation Settings" → "Settings menu 03" for details.			90 Vac ± 7 Vac (UPS mode) 80 Vac ± 7 Vac (Appliances mode) See chapter "Device Operation Settings" → "Settings menu 03" for details.		
Low Loss Return AC Input Voltage	180 Vac ± 7 Vac (UPS mode) 100 Vac ± 7 Vac (Appliances mode)			100 Vac ± 7 Vac (UPS mode) 90 Vac ± 7 Vac (Appliances mode)		
High Loss AC Input Voltage	280 Vac ± 7 Vac			140 Vac ± 7 Vac		
High Loss Return AC Input Voltage	270 Vac ± 7 Vac			135 Vac ± 7 Vac		
Maximum AC Input Voltage	300 Vac			150 Vac		
Nominal AC Input Frequency	50 Hz / 60 Hz					
Low Loss Frequency	40 Hz ± 1 Hz					
Low Loss Return AC Input Frequency	42 Hz ± 1 Hz					
High Loss AC Input Frequency	65 Hz ± 1 Hz					
High Loss Return AC Input Frequency	63 Hz ± 1 Hz					
Output Short Circuit Protection	Grid mode: Circuit breaker (amperage equivalent to maximum AC input current, resettable), Off-Grid mode: Electronic protection					
Transfer Time between Grid mode and Off-Grid mode and vice versa	10 ms typical (UPS mode), 20 ms typical (Appliances mode) Up to 50 ms when using multiple synchronized Any-Grids See chapter "Device Operation Settings" → "Settings menu 03" for details.					
AC Output Power De-Rating In Grid mode, the maximum AC output power is dependent on the AC input voltage.	Maximum AC output power formula when in Grid mode: 60 Aac x AC input voltage = Max. AC output power Example: 60 Aac x 230 Vac = 13,800 W	Maximum AC output power formula when in Grid mode: 40 Aac x AC input voltage = Max. AC output power Example: 40 Aac x 230 Vac = 9,200 W	Maximum AC output power formula when in Grid mode: 30 Aac x AC input voltage = Max. AC output power Example: 30 Aac x 230 Vac = 6,900 W	Maximum AC output power formula when in Grid mode: 60 Aac x AC input voltage = Max. AC output power Example: 60 Aac x 120 Vac = 7,200 W	Maximum AC output power formula when in Grid mode: 38.3 Aac x AC input voltage = Max. AC output power Example: 38.3 Aac x 120 Vac = 4,596 W	

12.2 Off-Grid Mode

Model	PSW-H-8KW-230/48V	PSW-H-5KW-230/48V	PSW-H-3KW-230/24V	PSW-H-5KW-120/48V	PSW-H-6.5KW-120/48V	PSW-H-3KW-120/24V
Nominal AC Output Power	8000 VA / 8000 W	5000 VA / 5000 W	3000 VA / 3000 W	5000 VA / 5000 W	6500 VA / 6500 W	3000 VA / 3000 W
AC Output Voltage Waveform	Pure Sine Wave					

AC Output Voltage Regulation	230 Vac \pm 5% (programmable, 220 ~ 240 Vac)		120 Vac \pm 5% (programmable, 110 ~ 127 Vac)		
Total Harmonic Distortion of Voltage	< 5% for linear load, < 10% for non-linear load at nominal voltage				
AC Output Frequency	50 Hz or 60 Hz (programmable)				
Peak Efficiency (from battery)	> 92%	> 93%	> 91%	> 92%	> 90%
AC Output Overload Protection	100 milliseconds @ \geq 205% nominal AC output power 5 seconds @ \geq 150% nominal AC output power 10 seconds @ 110% ~ 150% nominal AC output power				
AC Output Surge Capacity	2x nominal power for 5 seconds				
Nominal Battery Input Voltage	48 Vdc	24 Vdc	48 Vdc	24 Vdc	
Min. Battery Voltage for Inverter Start-up See chapter " Device Operation Settings " \rightarrow " Settings menu 29 " for details.	46.0 Vdc Default 2.0 Vdc. above "Low voltage disconnect" setting	23.0 Vdc Default 1.0 Vdc. above "Low voltage disconnect" setting	46.0 Vdc Default 2.0 Vdc. above "Low voltage disconnect" setting	23.0 Vdc Default 1.0 Vdc. above "Low voltage disconnect" setting	
Low Battery Warning Voltage (relative to nominal AC output power) load < 20% 20% \leq load < 50% load \geq 50%	46.0 Vdc 42.8 Vdc 40.4 Vdc	23.0 Vdc 21.4 Vdc 20.2 Vdc	46.0 Vdc 42.8 Vdc 40.4 Vdc	23.0 Vdc 21.4 Vdc 20.2 Vdc	
Low Battery Warning Return Voltage (relative to nominal AC output power) load < 20% 20% \leq load < 50% load \geq 50%	48.0 Vdc 44.8 Vdc 42.4 Vdc	24.0 Vdc 22.4 Vdc 21.2 Vdc	48.0 Vdc 44.8 Vdc 42.4 Vdc	24.0 Vdc 22.4 Vdc 21.2 Vdc	
Low Battery Voltage Disconnect (relative to nominal AC output power) load < 20% 20% \leq load < 50% load \geq 50%	Programmable, see chapter " Device Operation Settings " \rightarrow " Settings menu 29 " for details.				
	44.0 Vdc 40.8 Vdc 38.4 Vdc	22.0 Vdc 20.4 Vdc 19.2 Vdc	44.0 Vdc 40.8 Vdc 38.4 Vdc	22.0 Vdc 20.4 Vdc 19.2 Vdc	
High Battery Disconnect Voltage	66 Vdc	33 Vdc	66 Vdc	33 Vdc	
High Battery Return Voltage	64 Vdc	32 Vdc	64 Vdc	32 Vdc	
DC Voltage Accuracy	\pm 0.3%V at no load				
DC Offset	\leq 100 mV				

AC Output Power De-Rating in Off-Grid Mode

If the AC output load power is higher than the power in the diagram to the right, the AC output voltage will be decreased until the AC output power reaches the de-rated power specified to conserve battery. The lower limit of the AC output voltage de-rating is -20 / -40 Vac for 120 Vac models and 230 Vac models, respectively, compared to the nominal AC output voltage setting. For the PSW-H-6.5KW-120/48V the lower limit of the AC output de-rating is 95% x the nominal AC output voltage setting.

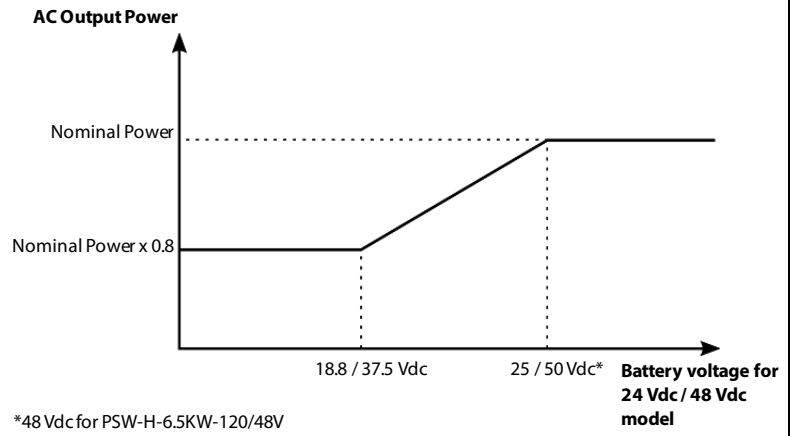

12.3 Battery Charging

Charging from AC Source						
Model		PSW-H-5KW-230/48V	PSW-H-3KW-230/24V	PSW-H-5KW-120/48V	PSW-H-6.5KW-120/48V PSW-H-8KW-230/48V	PSW-H-3KW-120/24V
Max. Battery Charging Current at Nominal AC Input Voltage		80 Adc			120 Adc	80 Adc
Boost Charging Voltage	Flooded Battery	58.4 Vdc	29.2 Vdc	58.4 Vdc		29.2 Vdc
	AGM / Gel Battery	57.6 Vdc	28.8 Vdc	57.6 Vdc		28.8 Vdc
Floating Charging Voltage		55.2 Vdc	27.6 Vdc	55.2 Vdc		27.6 Vdc
Overcharge Protection		66 Vdc	33 Vdc	66 Vdc		33 Vdc
Charging Algorithm		4-Stage with equalization				
Charging Curve		<p>If battery type "User-defined" is set in chapter "Device Operation Settings" → "Settings menu 05", the charging parameters are set with the following settings menus:</p> <p>Charge current limit: 11 Boost voltage: 26 Boost duration: 32 Float voltage: 27 Equalization: 33, 34, 35, 36, 37</p>				

Charging from MPPT Solar Charge Controller						
Model	PSW-H-8KW-230/48V	PSW-H-5KW-230/48V	PSW-H-3KW-230/24V	PSW-H-5KW-120/48V	PSW-H-6.5KW-120/48V	PSW-H-3KW-120/24V
Number of Independent MPPTs	2	1		2		1
Max. Usable Solar Power	4000 W per MPPT	4800 W	4000 W (2400 W for battery charging)	2400 W per MPPT	4000 W per MPPT	4000 W (2400 W for battery charging)
Max. Solar Array Power	5000 Wp per MPPT	6000 Wp	5000 Wp	3000 Wp per MPPT	5000 Wp per MPPT	5000 Wp
Max. Solar Array Open Circuit Voltage, Overvoltage Category	500 Vdc, OVC II	450 Vdc, OVC II		250 Vdc, OVC II		
Solar Array MPP Voltage Range	120 ~ 450 Vdc	120 ~ 430 Vdc	90 ~ 430 Vdc	90 Vdc ~ 230 Vdc		
Max. Usable Solar Input Current	27 Adc per MPPT, 40 Adc total	22 Adc		22 Adc per MPPT, 30 Adc total	22 Adc per MPPT, 36 Adc total	22 Adc
MPPT Start-Up Voltage	110 Vdc ± 10Vdc		80 Vdc ± 5Vdc			

12.4 General

Model	PSW-H-8KW-230/48V	PSW-H-5KW-230/48V	PSW-H-3KW-230/24V	PSW-H-5KW-120/48V	PSW-H-6.5KW-120/48V	PSW-H-3KW-120/24V
Certifications	RoHS, produced in ISO 9001 & ISO 14001 certified facility					
	CE, C _ϕ (CMIM Morocco)				UL1741, CSA C22.2 No. 107.1-16, FCC Class A	
Idle Self-Consumption (AC out on, PV / AC in unavailable)	< 75 W	< 40 W		< 58 W		< 40 W
Operating Temperature Range	-10 ~ 50 °C, 14 ~ 122 °F			-10 ~ 40 °C, 14 ~ 104 °F for UL compatibility; up to 50 °C, 122 °F without UL compatibility		
Storage Temperature	-15 ~ 60 °C					
Humidity	5% to 95% Relative Humidity (non-condensing)					
Ingress Protection, Pollution Degree	IP21, pollution degree 2, for indoor use					
Housing Dimensions (H x W x D)	584 x 433 x 148 mm / 23 x 17 x 5.8 in	478 x 309 x 143 mm / 18.8 x 12.2 x 5.6 in		584 x 433 x 148 mm / 23 x 17 x 5.8 in	584 (651) x 433 x 148 mm / 23 (25.6) x 17 x 5.8 in (with extension box)	478 x 309 x 143 mm / 18.8 x 12.2 x 5.6 in
Net Weight	21.5 kg / 47.4 lbs	12 kg / 26 lbs	11.2 kg / 24.7 lbs	18 kg / 40 lbs	18.2 kg / 40 lbs	12 kg / 27 lbs

13.0 Warranty

13.1 Conditions

We warranty this product against defects in materials and workmanship for a period of 24 months from the date of purchase and will repair or replace any defective unit when directly returned, postage paid, to Phocos. This warranty will be considered void if the unit has suffered any obvious physical damage or alteration either internally or externally. This warranty does not cover damage arising from improper use, such as plugging the unit into unsuitable power sources, attempting to operate products that require excessive power consumption, or use in unsuitable environments. This is the only warranty the company makes. No other warranties express or implied including warranties of merchantability and fitness for a particular purpose. Repair and replacement are your sole remedies and the company shall not be liable for damages, whether direct, incidental, and special or consequential, even if caused by negligence.

Further details about our warranty conditions can be found at www.phocos.com.

13.2 Liability Exclusion

The manufacturer shall not be liable for damages, especially on the battery, caused by use other than as intended or as mentioned in this manual or if the recommendations of the battery manufacturer are neglected. The manufacturer shall not be liable if there has been service or repair carried out by any unauthorized person, unusual use, wrong installation, or incorrect system design.

Specifications are subject to change without notice.
Copyright © 2020 - 2022 Phocos AG, All Rights Reserved.
Version: 20220218
Made in China

Phocos AG
Magirus-Deutz-Str. 12
89077 Ulm, Germany

Phone +49 731 9380688-0
Fax +49 731 9380688-50

www.phocos.com
info@phocos.com

