

	REVISED	DR	APP

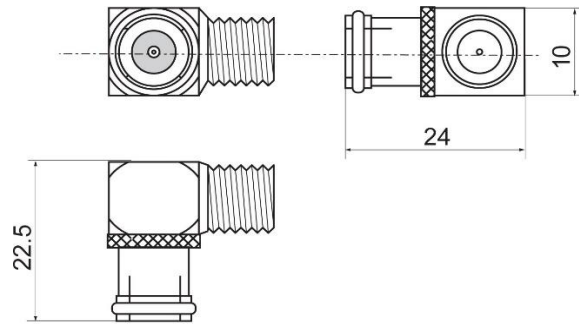

HF-Winkeladapter

- Anschlüsse: F-Quick Stecker > F-Kupplung
- Material: Kupfer
- Impedanz: 75 Ohm
- Frequenzband: 5-2400 MHz
- Gewicht: 12,3 g
- Winkel: 90°
- RoHS-konform



1	CONNECTORS	90° F ADAPTOR F QUICK PLUG - F JACK
2	MOLDING	
3	CABLE	
NO	PART NAME	



DESCRIPTION		90° F ADAPTOR F QUICK PLUG - F JACK					
SIZE	A4	DATE	21.11.2018	CHECKED		TOL	
UNIT	MM	DRAWN	R.Hueller	APPROVED			BS13-301614
CUSTOM TARIF NO.: 85369010000							