

dji OSMO POCKET 3

User Manual

v1.0 2023.10

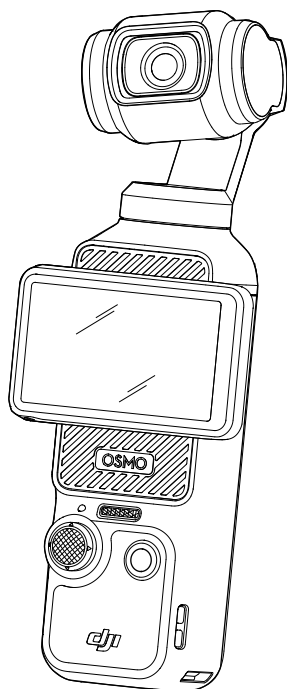



This document is copyrighted by DJI with all rights reserved. Unless otherwise authorized by DJI, you are not eligible to use or allow others to use the document or any part of the document by reproducing, transferring or selling the document. Users should only refer to this document and the content thereof as instructions to operate DJI UAV. The document should not be used for other purposes.

Searching for Keywords

Search for keywords such as “battery” and “install” to find a topic. If you are using Adobe Acrobat Reader to read this document, press Ctrl+F on Windows or Command+F on Mac to begin a search.

Navigating to a Topic

View a complete list of topics in the table of contents. Click on a topic to navigate to that section.

Printing this Document

This document supports high resolution printing.

Using this Manual

Legends

⚠ Important

💡 Hints and Tips

Read Before Use

Read the following documents before using DJI™ Osmo Pocket 3.

1. Safety Guidelines
2. Quick Start Guide
3. User Manual

It is recommended to watch all the tutorial videos on the official DJI website or in the DJI Mimo app and read the safety guidelines before using for the first time. Make sure to review the Quick Start Guide and refer to this User Manual for more information.

Download DJI Mimo App and Watch the Tutorial Videos

Scan the QR code to download the DJI Mimo App and watch the tutorial videos.



iOS 12.0 or above



Android 8.0 or above

Contents

Using this Manual	3
Legends	3
Read Before Use	3
Download DJI Mimo App and Watch the Tutorial Videos	3
Introduction	5
Overview	5
Accessories	6
Using for the First Time	9
Inserting the microSD Card	9
Powering on	9
Activation	10
Charging the Battery	11
Basic Operations	12
Button Features	12
Operating the Touchscreen	13
Status LED	20
Using the Product	20
Setting the Shooting Mode	20
Selecting the Gimbal Mode	22
Using ActiveTrack	23
Using the Smart Gimbal Mode	23
Transferring Files	25
Webcam Mode	25
Microphone Connection	26
DJI Mimo App	30
Downloading the DJI Mimo App	30
Connecting to the DJI Mimo App	31
DJI Mimo App Home Screen	31
Camera View	32
Maintenance	33
Firmware Update	33
Storing	33
Usage Notices	35
Optional Accessories (Not Included)	35
Specifications	37

Introduction

DJI Osmo Pocket 3 is a handheld gimbal camera with three-axis mechanical stabilization, which is capable of shooting stable and smooth videos in various scenarios. The 1-inch CMOS sensor ensures low-noise, high-quality footage in high-contrast environments. In addition, the 10-bit D-Log M color mode provides a more comfortable color perception and a larger dynamic range, which is convenient for post-production color correction.

The rotatable touchscreen of Osmo Pocket 3 allows users to check the live view of the camera, rotate to start recording, tap to adjust the settings, and can also be used to switch between horizontal and vertical shooting modes. Osmo Pocket 3 adopts a built-in three-mic array, which can effectively reduce wind noise and record stereo sound. It also supports the connection of external mics and monitoring earphones. Users can enjoy more with a variety of optional accessories such as Osmo Pocket 3 Handle With 1/4" Thread, Osmo Pocket 3 Battery Handle, Osmo Mini Tripod, and Osmo Pocket 3 Wide-Angle Lens.

Overview

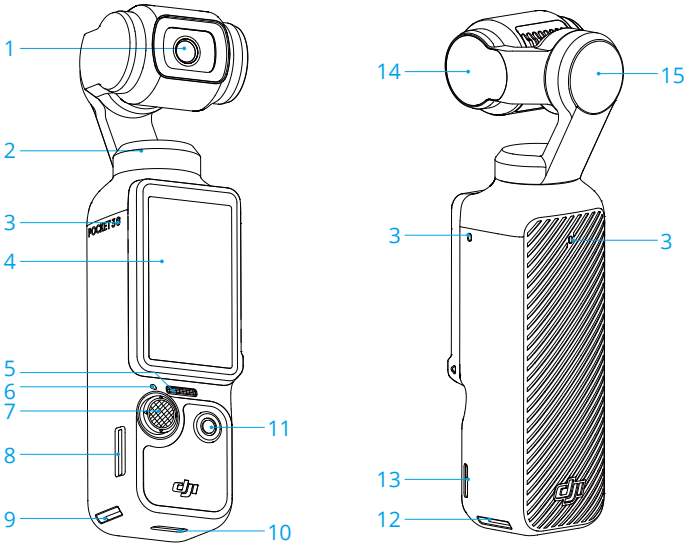

- | | | |
|--------------------------|-------------------------|---------------------------|
| 1. Camera | 6. Status LED | 11. Shutter/Record Button |
| 2. Pan Motor | 7. 5D Joystick | 12. Quick-Release Slot II |
| 3. Microphones* | 8. microSD Card Slot | 13. Lanyard Hole |
| 4. Rotatable Touchscreen | 9. Quick-Release Slot I | 14. Tilt Motor |
| 5. Speaker | 10. USB-C Port | 15. Roll Motor |

* For better audio quality, DO NOT block the microphones when recording video.

Accessories

Osmo Pocket 3 Handle With 1/4" Thread

The Osmo Pocket 3 Handle With 1/4" Thread (hereinafter referred to as "handle") makes it more comfortable to hold when recording.* When mounting, connect the handle to the USB-C port at the bottom of Osmo Pocket 3. The USB-C port on the rear of the handle can be used for charging, or connecting external audio devices such as wired digital headphones, wired microphones, and the wireless microphone receiver.

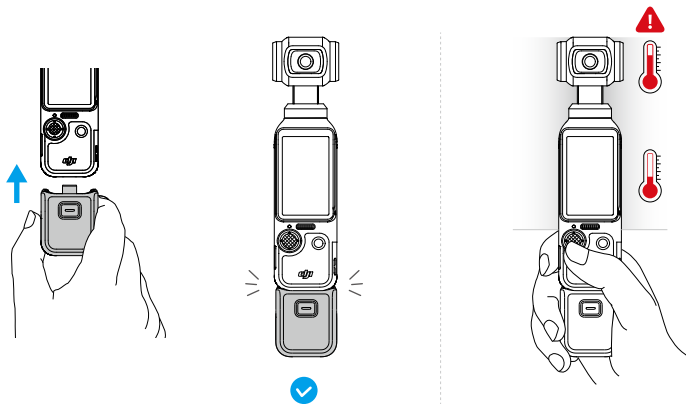

* Hold Osmo Pocket 3 as shown in the illustration. After shooting high-specification videos for an extended period, the upper part of the product may become hot. DO NOT hold too high to avoid high temperatures.

When detaching, press and hold the release button on the handle and unplug the handle.

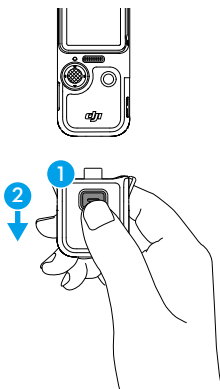

Osmo Pocket 3 Battery Handle

The Osmo Pocket 3 Battery Handle (hereinafter referred to as "battery handle") has a built-in 950mAh battery, which can greatly extend the operating time when connected to Osmo Pocket 3. When mounting, connect the battery handle to the USB-C port at the bottom of Osmo Pocket

3. Make sure the battery handle is firmly attached and the clips on the two sides are locked into place. Once mounted, the power level of the battery handle can be checked on the rotatable touchscreen. The USB-C port on the rear of the battery handle can be used for charging or connecting external audio devices such as wired digital headphones, wired microphones, or the wireless microphone receiver.

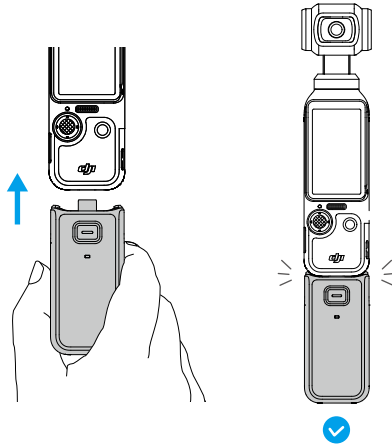

When detaching, press and hold the release button on the battery handle and unplug the handle. After the battery handle is detached, press the release button once to check the battery level using the status LED.

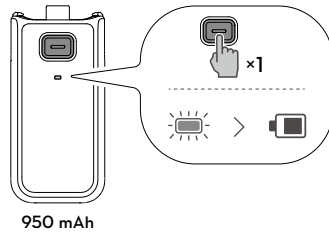

Status LED	Battery Level
Solid red for 3 s and turns off	0% - 19%
Solid yellow for 3 s and turns off	20% - 49%
Solid green for 3 s and turns off	50% - 100%
Blinks green	Charging
Off	Fully Charged

- ⚠ • Make sure the battery handle has power when used with external audio devices.
- Make sure the battery handle is properly insulated to prevent fire hazards. DO NOT drop or strike the battery handle.
- It is recommended to use the DJI 65W Portable Charger or DJI 30W USB-C Charger (not included) to charge the battery handle.

- ⚠ • If foreign object is obstructing the USB-C port, use an air blower, soft brush, or other tools to clean the USB-C port and remove the foreign object. Note to sweep from the inside of the port to the outside.
 - The battery handle is not waterproof. DO NOT drop it in water or spill any liquid on the handle.
 - Discharge the battery handle to 50% battery level if it is not used for 10 days or more in order to extend the battery life.
-

Osmo Pocket 3 Wide-Angle Lens

Attach the magnetic Osmo Pocket 3 Wide-Angle Lens to the camera as shown to achieve a wider shooting angle with 108° FOV and 15mm equivalent focal length.



- ☀ • With the wide-angle lens attached, the camera will face in the same direction as the touchscreen when powered off. In this state, the handheld gimbal camera can be stored in the Osmo Pocket 3 Protective Cover directly. The wide-angle lens can also be detached and stored in the dedicated storage location in the Osmo Pocket 3 Protective Cover.
 - ⚠ • The wide-angle lens is a small object. Keep it away from children to avoid swallowing.
 - Keep the camera lens and both sides of the wide-angle lens clean. Dust or sand may scratch the lens and result in the wide-angle lens falling off.
-

Osmo Mini Tripod

Both the handle and battery handle have a 1/4" screw hole at the bottom, which can be used to install the Osmo Mini Tripod. The mini tripod enables the Osmo Pocket 3 to stand on a flat surface and shoot footage from a fixed position.

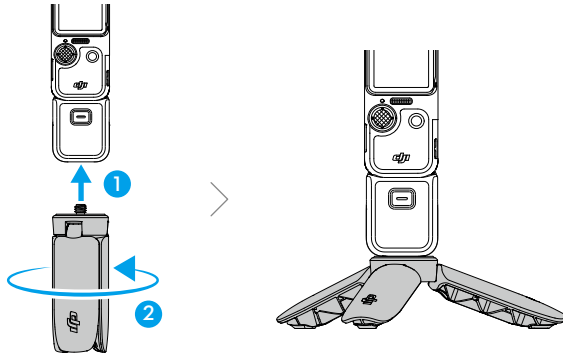

Using for the First Time

Inserting the microSD Card

The footage shot on Osmo Pocket 3 can only be stored on a microSD card (not included). A UHS-I Speed Grade 3 rating microSD card is required due to the fast reading and writing speeds necessary for high-resolution video data. Refer to the recommended microSD card list in the Specifications section for more information.

Insert the microSD card into the microSD card slot as shown. To remove the microSD card, gently push the microSD card to partially eject it.

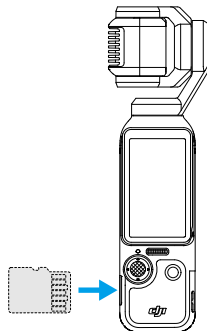



The photos and videos can be transferred to a mobile device or computer. Refer to the Transferring Files section for more information.

Powering on

Rotate the touchscreen clockwise or press the Shutter/Record button to power on the Osmo Pocket 3. If the Screen Rotate & Capture function has been enabled from the control menu, the

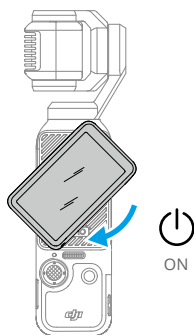
Osmo Pocket 3 will start capturing footage as soon as you rotate the touchscreen and power on the camera. The shooting mode is subject to the users selection in the Screen Rotate & Capture function settings. After shooting, the camera will automatically power off if left idle for two seconds. Alternatively, users can press the Shutter/Record button for one second or rotate the touchscreen counterclockwise to power off the camera.



-
-  • The rotate screen to power off function can be configured as follows:
1. Swipe down from the top of the screen to enter the control menu.
 2. Tap the settings icon.
 3. Scroll down and tap Rotate screen to power off. Then select Now, 2s, or Never.
 - a. When Now is selected, the camera will power off immediately after you rotate the touchscreen counterclockwise.
 - b. When 2s is selected, after rotating the touchscreen, a prompt will be displayed asking whether to continue shooting. If you do not select within 2 seconds, the camera will power off.
 - c. When Never is selected, the camera will continue to shoot after rotating the screen.
-

Activation

Make sure to activate the camera using DJI Mimo before first use. Follow the steps below to activate:

1. Rotate the touchscreen clockwise or press the Shutter/Record button to power on the camera.
2. Enable Wi-Fi and Bluetooth on the mobile device.
3. Launch DJI Mimo on the mobile device, tap  to connect to the camera, and then follow the instructions to activate the camera.

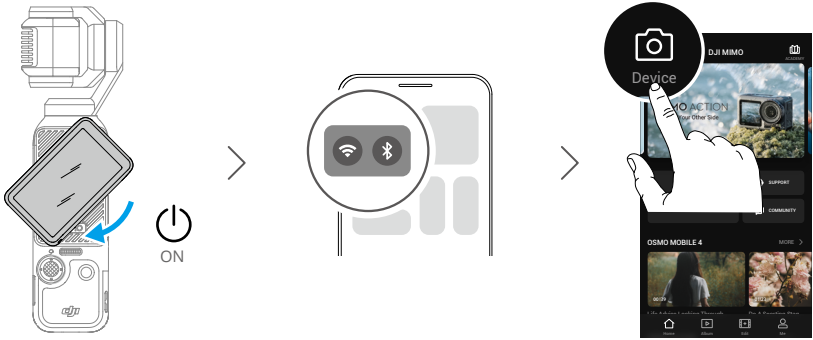

Refer to the DJI Mimo App section for more information on how to use the app.

- ⚠️ • If DJI Mimo prompts to update the firmware after activation, tap the notification to update the firmware to the latest version for a better shooting experience. Ensure the battery level is above 15% before updating the firmware.

Charging the Battery

Use the Type-C to Type-C PD cable (included) to connect a USB-C charger (not included) to the USB-C port at the bottom of Osmo Pocket 3. It is recommended to use the DJI 65W Portable Charger, DJI 30W USB-C Charger, or other USB-C Power Delivery chargers. When charging in the power-off state, the power status can be checked on the touchscreen. It takes about 16 minutes to charge the battery to 80% and 32 minutes until fully charged.*

* Tested in a laboratory environment with the DJI 65W PD charger (sold separately).

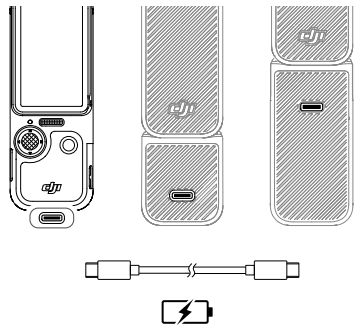

When the handle or battery handle is mounted, use the USB-C port on the rear of the handle for charging.

- ⚠️ • If the battery handle is mounted, the battery handle will not start charging until the battery of the handheld gimbal camera is fully charged.

Basic Operations

Button Features

Shutter/Record Button

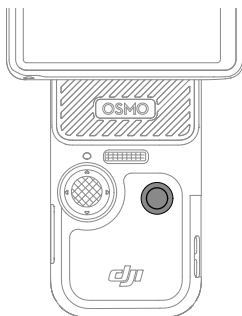

Operation	Descriptions
Press once when in live view	Take a photo or start/stop recording.
Press once when powered off	Power on
Press and hold for 1 second	Power off

5D Joystick

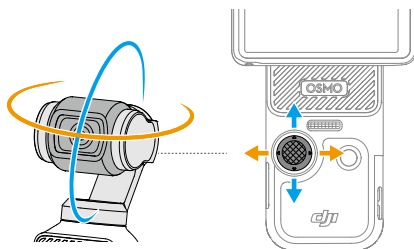

Operation	Descriptions
Press once	Back
Press twice	Recenter the gimbal.
Press three times	Switch the camera between facing forward and backward.
Push left or right	Control the camera movement in the pan axis.
Push up or pull down	Control the camera tilt or zoom.
Press and hold	Lock the gimbal.

Operating the Touchscreen

After the handheld gimbal camera is powered on, the touchscreen displays the live view and other information such as the shooting mode, the battery level, and the microSD card information. Tap or swipe on the touchscreen to interact with the handheld gimbal camera.

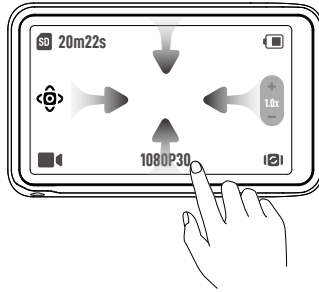

Tap once: tap an icon to select features such as smart gimbal mode and rotate the camera. Tap on the live view for focusing and spot metering.

Tap twice: select a subject for ActiveTrack in the live view.

Swipe down from the top of the screen: enter the control menu.

Swipe up from the bottom of the screen: set shooting parameters such as Aspect Ratio, Countdown Timer, and Resolution.

Swipe right from the left edge: enter playback and view the last taken footage.

Swipe left from the right edge: adjust the image and audio parameters.

Camera View

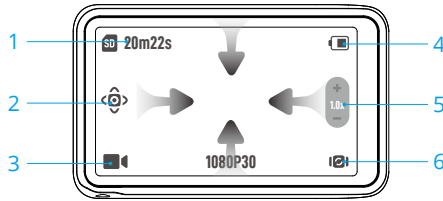

1. Storage Capacity Information

SD 20m22s : displays the remaining number of photos or the video duration that can be taken or recorded according to the current shooting mode. The icon is displayed only when a microSD card is inserted.

2. Smart Gimbal Mode

Gimbal Mode Icon : tap to select the smart gimbal mode according to the on-screen description. This function is only available in Video mode. Refer to the Using the Smart Gimbal Mode section for more information.

3. Shooting Modes

Shooting Mode Icon : tap the icon and swipe to select the shooting mode from Panorama, Photo, Video, Low Light, Slow Motion, and Timelapse. Refer to the Setting the Shooting Mode section for more information.

4. Battery Level

Battery Level Icon : displays the current battery level. Tap the icon to view more detailed information. When the Osmo Pocket 3 Battery Handle is mounted, tap the icon to view the battery level of the handheld gimbal camera and the battery handle.

5. Zoom

Zoom/Tilt Slider : tap to switch the function of the slider between camera zoom and camera tilt. When the slider changes to **Zoom**, drag the slider to adjust the camera zoom. Toggle the 5D joystick up and down to adjust the camera tilt. When the slider changes to **Tilt**, drag the slider to adjust the camera tilt. Toggle the 5D joystick up and down to adjust the camera zoom.

6. Gimbal Rotate

Gimbal Rotate Icon : tap to switch the camera between facing forward and backward.

Swipe Down - Control Menu

Swipe down from the top of the screen to enter the control menu.

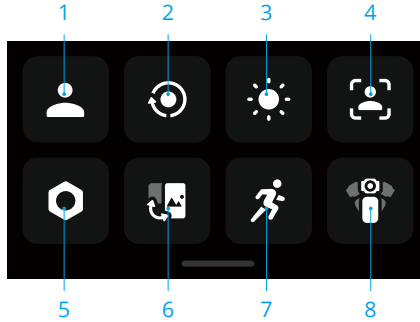

1. Custom Mode

Tap to create and manage custom modes. Save the shooting parameters in the custom mode, which can then be used directly to shoot similar scenes. Users can save up to five custom modes.

2. Screen Rotate & Capture

When this function is enabled, footage shooting will be started as soon as you rotate the touchscreen clockwise to power on the camera.

It is the quickest way to start shooting and never miss a moment of the action. Set the shooting mode when enabling the Screen Rotate & Capture. The shooting mode can be set to Last Settings, Video, Hyperlapse, Low-Light, and Custom. After shooting, the camera will automatically power off if left idle for two seconds.

- ☀️ • Once the user has started shooting by using screen rotation, the user can rotate the touchscreen counterclockwise to achieve the following:
 - a. If the shooting orientation is set to Auto-Rotation or Landscape, the recording stops and the camera will power off after two seconds.
 - b. If the shooting orientation is set to Portrait, shooting will continue.

3. Brightness

Tap and slide to adjust the brightness.

4. FT (Selfie)

When enabled, the camera will automatically recognize and follow your face to ensure the best selfie angle.

5. Settings

Item	Descriptions
Wireless Microphone	Tap and select TX1 or TX2 to link with the wireless microphone using Bluetooth. Once successfully linked, related parameters can be set. Note that linking via Bluetooth is only supported with the DJI Mic 2 Transmitter. Refer to the Microphone Connection section for more information.

Gimbal Startup Direction	<p>Set the direction the camera faces when powered on.</p> <p>Forward: the camera will rotate and face away from the user.</p> <p>Backward: the camera will rotate and face toward the user.</p> <p>Last Setting: if the gimbal mode is set to Follow or Tilt Locked, the camera will face forward or backward. If the gimbal mode is FPV, the camera will rotate to resume the same orientation when powered off last time.</p>
Rotate screen to power off	If enabled, the camera can be powered off by rotating the touchscreen when not recording.
Selfie Flip	Enable to obtain a better selfie effect by mirroring the image automatically.
OTG Connection	Tap OTG Connection to connect the handheld gimbal camera to the Android device with the Type-C to Type-C PD cable (included). When connected, view and transfer photos and videos via the device album or file management. Note: OTG Connection is only available when the Android device supports OTG connection.
Wireless Connection	Tap to check wireless information, select Wi-Fi frequency, and reset the Wi-Fi connection. Connect the device to DJI Mimo wirelessly to update the firmware version.
Wearable Mode	<p>After enabled, the camera will rotate and lock in the selfie mode and the gimbal mode will change to Tilt Locked.</p> <p>Tap twice on the screen to recenter the gimbal. Swipe up to exit Wearable mode. In Wearable mode, it is recommended to use the gimbal camera together with the Osmo Pocket 3 Expansion Adapter (not included) to get a better first-person view shooting experience.</p>
Gimbal Calibration	Tap and confirm to calibrate the gimbal. Calibration can reduce gimbal drift caused by human error or nearby magnetic interference. DO NOT hold the gimbal camera during calibration. Make sure to place it on a stable and flat surface.
Joystick Speed	Set the zoom speed and gimbal rotation speed controlled by the 5D joystick. A higher value means higher response sensitivity.
Video Compression	Tap to configure the video coding format. Efficiency (HEVC) is the default value. Compatibility (H.264) can be selected. If Efficiency is selected, videos will be encoded in HEVC with a smaller file size. If Compatibility is selected, videos will be encoded in H.264 with higher compatibility.
Sounds	Tap to set volume.
Grid	Tap to display grid lines in live view photos or videos to help level the camera vertically and horizontally.

Anti-Flicker	Tap to select the anti-flicker frequency to reduce flicker caused by fluorescent lights or TV screens when shooting indoors. Select the anti-flicker frequency according to the power grid frequency in the region. The default anti-flicker frequency is set as Auto.
Timecode	Tap to set Timecode for the camera. Either reset the timecode or sync with the system time. The camera timecode can be synchronized by a time code synchronizer using the USB-C port.
Naming Management	Tap to edit the naming rules for storage folders and files.
Scrn Off When Rec	Tap to set the time. After recording starts, the screen will turn off after the set time. This will not affect the recording.
Auto Power Off	Tap to set the time. The camera will power off automatically when there is no operation on camera within the set duration.
LEDs	Tap to turn the status LED on or off.
Continue Last Livestream	Tap to continue the livestream according to the settings of the last time livestream. Note that Livestream is only available on DJI Mimo.
Language	Tap to set the language.
Format	Tap and swipe to format the microSD card. Formatting will permanently delete all data on the microSD card. Make sure to back up all required data before formatting.
Factory Reset	Tap to restore the camera to its original factory settings. This will delete all the current settings, and the camera will be restored to the original factory settings and restart.
Device Info	Tap to view information such as the device name, serial number, firmware version, quick start guide. Tap Export Log to export the log to the microSD card.
Compliance Info	Tap to view the compliance information.

6. Switching between Landscape and Portrait Mode

Tap and select the shooting orientations: Auto-Rotation, Landscape, and Portrait.

7. Rotational Speed

Tap to adjust the gimbal following speed.

8. Gimbal Modes

Tap to select the gimbal mode: Follow, Tilt Locked, and FPV. Refer to the Selecting the Gimbal Mode section for more information.

Swipe Up - Parameters Settings

Swipe up from the bottom of the screen to set the parameters for each shooting mode.

Shooting Modes	Settings
Panorama	Select 180° or 3×3 panorama photo and set Countdown Timer.
Photo	Set Aspect Ratio and Countdown Timer.
Video	Set video resolution, frame rate, and aspect ratio.
Low-Light	Set video resolution and frame rate.
Slow Motion	Set the video resolution and speed ratio.
Timelapse	Select Hyperlapse, Timelapse, or Motionlapse. Tap the upper right corner to set the resolution and frame rate.

Swipe Right - Playback

Swipe right from the left edge of the screen to view the last taken footage. Swipe left from the right edge of the screen to go back to live view.

 After connected to DJI Mimo, the favorite photos or videos can be viewed from Favorites of the DJI Mimo Album.

 Tap to mark as Favorites.

 Delete the photo or video.

Swipe Left - Image Settings

Swipe left from the right edge of the screen to enter image and audio settings. Tap PRO to adjust pro parameters. Different parameters can be set in different shooting modes as shown in the below table.

Shooting Modes	PRO Mode								
	Settings	Exposure	White Balance	Format	Focus Mode	Image Adjustment	Glamour Effects	Colors	Audio Parameters
Panorama	✓	✓	✓	✓					
Photo	✓	✓	✓	✓					
Video	✓	✓			✓	✓	✓	✓	✓
Low-Light	✓	✓			✓		✓		✓
Slow Motion	✓	✓			✓	✓			✓
Timelapse	✓	✓	✓	✓					
Hyperlapse	✓	✓			✓	✓			✓
Motionlapse	✓	✓	✓						

Refer to the table below for detailed information of each parameter setting.

Exposure	Auto and M (manual) modes are available.
White Balance	AWB (Auto White Balance) and M (manual) modes are available.
Format	When shooting panorama photo, the format can be set as JPEG or JPEG+RAW. When taking a photo, JPEG and JPEG+RAW are available. In Timelapse and Motionlapse mode, the format can be video, Video+JPEG, or Video+RAW.
Focus Mode	Single: Auto-focus operates one single time, which is suitable for capturing motionless subjects. Continuous: Auto-focus continues to operate, which is suitable for capturing moving subjects. Product Showcase Mode: Focuses on subjects in the foreground, which is suitable for showing subjects closer to the camera. Product Showcase Mode is only available in Video mode.
Image Adjustment	In Video, Slow Motion, and Hyperlapse shooting mode, the sharpness and noise reduction can be adjusted for optimal image quality.
Glamour Effects	Enable or disable the glamour effects. After enabled, the user can view and adjust the effect via DJI Mimo. Footage downloaded via DJI Mimo can be automatically beautified.
Colors	There are three options: Normal, HLG, and D-Log M. <ul style="list-style-type: none"> D-Log M is designed for professional color grading when post-editing. In high-contrast or multi-color (e.g., garden, field, etc.) scenarios, it can enlarge the dynamic range for more color-tuning in post-production. 10-bit color depth enables smoother color transition. HLG mode records with wide dynamic range and color gamut which can be displayed on an HLG-compatible TV or monitor.
Audio Parameters	In Video, Low-Light, Slow Motion, and Hyperlapse shooting modes, Channel, Wind Noise Reduction, Directional Audio, and Gain can be set. <ul style="list-style-type: none"> Channel: select Stereo or Mono. Wind Noise Reduction: when enabled, the camera will reduce the wind noise picked up by the built-in microphone. Note that Wind Noise Reduction does not work when connected to the external microphone. Directional Audio: when Front is selected, the built-in microphone will enhance the reception of the sound in front of the camera. When Front and Back is selected, the built-in microphone will enhance the sound recording at the front and rear of the camera. When All is selected, sounds from all directions around the camera will be recorded. Directional Audio is not supported when external microphones are used. Gain: when an external microphone is connected, the input gain of the microphone can be adjusted.

Status LED

The status LED can be turned on and off from the camera settings.

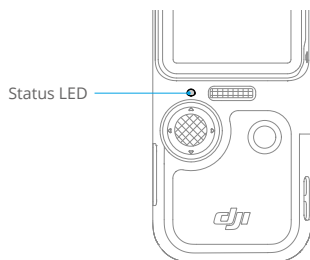

Blinking Pattern	Descriptions
Solid green	Ready to use
Temporarily off	Taking a photo
Blinks red slowly	Recording a video
Blinks red three times rapidly	Powering off, or about to power off because of low battery
Blinks red and green alternately	Updating firmware

Using the Product

Setting the Shooting Mode

Tap the icon and swipe to select the shooting mode.

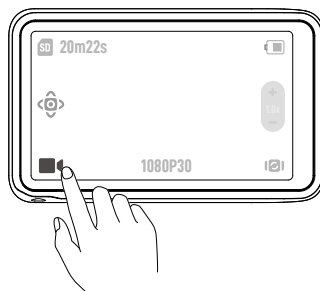

Shooting Modes	Descriptions
Panorama	<p>Take a panoramic photo with an ultra-wide angle view. The camera will take a group of photos for the view within the FOV and then combine them into a panoramic photo.</p> <p>There are two panoramic modes: 180° and 3×3.</p> <p>If 180° is selected, the camera will take four horizontal photos from left to right and combine them into a panoramic photo.</p> <p>If 3×3 is selected, the camera will take nine photos from different directions and combine them into the final panoramic photo.</p>
Take a photo	Take a photo or countdown photo.
Video	Record a video.
Low-Light	When selected, the camera will automatically adjust exposure parameters intelligently to improve image quality in low-light environments.
Slow Motion	Supports 4x or 8x slow-motion video shooting. In Slow Motion mode, the camera records the video with a high frame rate and slows the footage down to 4x or 8x the normal speed during playback. Slow Motion catches details not visible to the naked eye, which is ideal for fast-action shots. Note that slow-motion videos do not include audio. The audio file is stored as a standalone file and has the same path as the video file, which can be transferred to your computer.
Timelapse	<p>Select from Hyperlapse, Timelapse, and Motionlapse. In this mode, the camera turns long events into short videos by taking a frame of video at set intervals.</p> <ul style="list-style-type: none"> • Use Hyperlapse to record smooth timelapse videos when the camera is in motion such as in a car or when held in the hand. • Use Timelapse to record timelapse videos when the camera is mounted and still. Three presets in Timelapse are designed for typical scenes such as Crowds, Clouds, and Sunsets. Users can also optimize the interval and duration for recording Timelapse videos. • Motionlapse allows you to move along preset shooting positions and record a timelapse video from different angles. Motionlapse supports LTR (Left to Right), RTL (Right to Left), and Custom Motion. When using Custom Motion, select 2-4 positions and the gimbal will move to each position in sequence.

Selecting the Gimbal Mode

Swipe down from the top of the screen to enter the control menu. Tap the icon to select the gimbal mode.

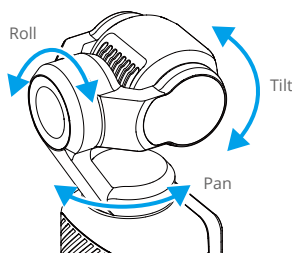
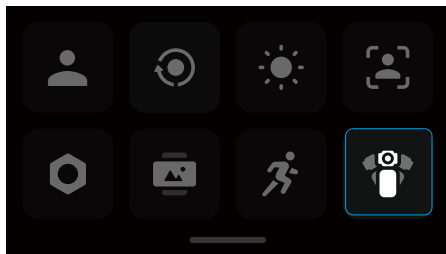

Follow

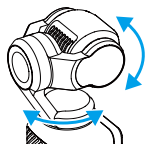

Follow is selected by default. In this mode, the pan and tilt axes follow the handle while the roll axis remains level. This mode is suitable for most scenarios, including vlogs and selfie videos.

Tilt Locked



In this mode, only the pan axis follows while the tilt axis is locked and the roll axis remains level. This mode is suitable for scenarios such as where the camera position switches between high and low.

FPV

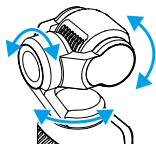

In this mode, the camera rotates freely and follows the handle movement. This mode is suitable for scenarios where the camera position is continuously rotating and there is less stability.

Using ActiveTrack

When in Photo or Video mode, tap twice on the touchscreen to select a subject and enable ActiveTrack. At this time, the gimbal camera will automatically follow the selected subject. Press the 5D joystick or tap the touchscreen to exit ActiveTrack.

When FT (Selfie) is enabled, the camera will automatically recognize and tracks your face once the camera rotates to take a selfie, helping ensure the best selfie angle.

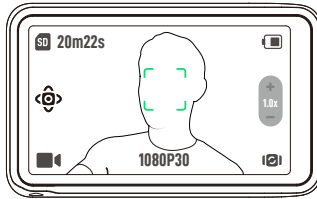

ActiveTrack is not available in the following scenarios:

- When the shooting mode is Panorama, Low-Light, Slow motion (1080P 8X/4K 4X), Timelapse, and Motionlapse.
- When the SpinShot is enabled.

Using the Smart Gimbal Mode

In Video mode, tap the icon to select the smart gimbal mode and tap again to exit. Smart gimbal mode includes the following three modes.

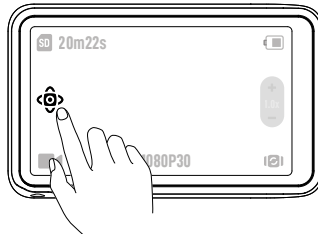

Face Auto-Detect Mode



Camera will automatically follow the face closest to the center of camera view.

Dynamic Framing Mode

Select the subject position in the live view based on the golden ratio or the rule of thirds via the 5D joystick. After the subject enters the frame, press the joystick to track the subject while keeping the subject at the selected position.

SpinShot Mode

The camera will automatically rotate 90° or 180° when shooting.

- When 90° is selected, press the 5D joystick or tap the icon to enable SpinShot mode with 90°. Click  to make the camera to rotate 90° counterclockwise on the roll axis, and click  to make the camera to rotate 90° clockwise on the roll axis.

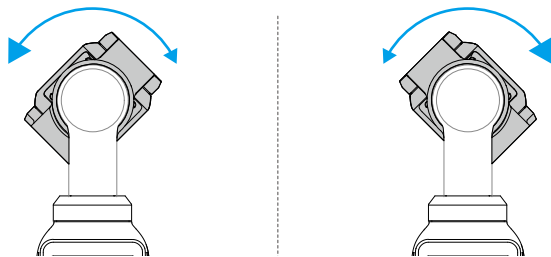

- When 180° is selected, press the 5D joystick or tap  to enable SpinShot mode with 180°. The camera will recenter first and face upward, and then rotate 180° on the pan axis.

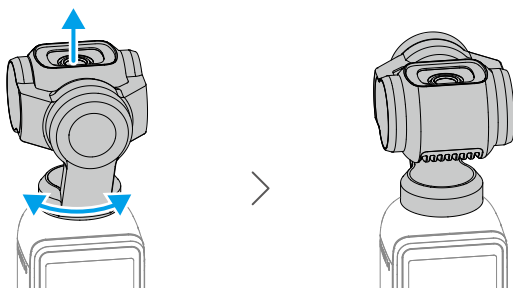

Transferring Files

Transferring Files to a Phone

Connect Osmo Pocket 3 to DJI Mimo, tap the Playback icon to preview photos and videos. Click  to download photos and videos. The photos and videos can be shared directly from DJI Mimo to social media platforms.

Transferring Files to a Computer

Power on Osmo Pocket 3 and connect it to a computer using a USB-C cable. When connected to a computer, a pop-up will appear. Tap Transfer File/OTG Connection to download the files from the handheld gimbal camera to the computer. When transferring a file, the camera cannot take photos or record videos.

Select Cancel to only charge the device.

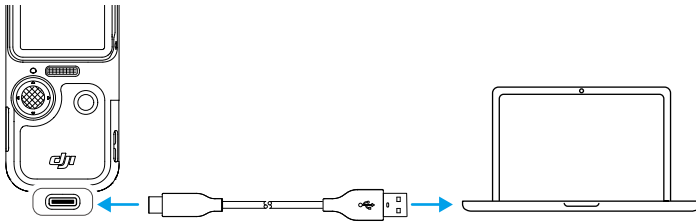

- Reconnect the device to the computer if a file transfer is interrupted.

OTG Connection for Transferring Files

For Android devices that support OTG connection, the files can be transferred from the camera to the Android device with OTG connection.

Connect the camera to the Android device with the Type-C to Type-C PD cable (included) using the USB-C port on Osmo Pocket 3. When connected, view and transfer the photos and videos of the camera via the Android device album or file management.



- If the camera cannot automatically recognize the Android device using the OTG connection, swipe down from the top of the screen and enter the control menu. Tap Settings > OTG Connection, and use the Type-C to Type-C PD cable to connect the camera to the device.

Webcam Mode

Osmo Pocket 3 can work as a webcam on a computer. Power on the device and connect it to the computer using a USB cable. The device will go into USB mode. Tap Webcam to enter the Webcam mode, and the device will function as a webcam input device. The bottom of the

screen displays Webcam. Press the shutter/record button to start recording. Swipe left from the right edge of the screen to view parameters such as, Exposure, White Balance, and Focus Mode. Users can preview recorded videos after exiting the Webcam mode.

Microphone Connection

Osmo Pocket 3 can be linked to an external microphone, including DJI Mic, DJI Mic 2, or any third-party digital USB-C microphones that support 48K/16bit.

Connecting to DJI Mic 2

DJI Mic 2 Transmitter Overview

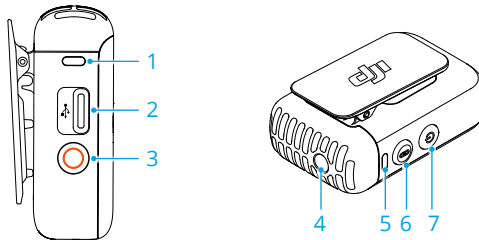

1. Recording Status LED

Indicates the record status of the transmitter.

2. Data Port (USB-C)

For charging and copying audio files or updating firmware after connecting to a computer.

3. Record Button

Press once to start or stop recording in standalone recording mode.

4. 3.5mm TRS Input

For connecting an external microphone. DO NOT connect a microphone with a power supply of 24 V or 48 V.

5. System Status LED

Indicates the system status of the transmitter.

6. Linking Button

Press and hold for two seconds to start linking via Bluetooth.



7. Power Button

Press and hold for two seconds to power on or off. Press once to enable or disable noise cancelling.

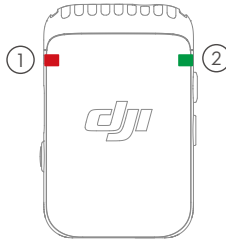





DJI Mic 2 Transmitter Status LEDs















① Recording Status LED

Blinking Pattern	Descriptions
 — Solid red	The transmitter is recording independently.
 Off	The transmitter is not recording independently.

② System Status LED

Blinking Pattern	Descriptions
 ····· Blinks green slowly	Reserved Status
 — Solid blue	Linked via Bluetooth
 ····· Blinks blue slowly	Ready to link via Bluetooth
 ····· Blinks blue quickly	Linking
 — Solid yellow	Noise Cancelling is enabled when the transmitter is linked to the Bluetooth device.
 ····· Blinks yellow	Noise Cancelling is enabled when the transmitter is not linked to the Bluetooth device.

Battery Level Descriptions

 — Solid red	 0-10%
 ····· Blinks green slowly	 0-25%
 ····· Blinks green twice	 26-50%
 ····· Blinks green three times	 51-75%
 ····· Blinks green four times	 76-99%
 Off	 Fully charged

DJI Mic 2 Transmitter Connection

Follow the steps below to connect to DJI Mic 2 (hereinafter referred to as “transmitter”).

1. Swipe down from the top of the screen and enter the control menu. Tap the settings icon and select Wireless Mic > TX1/TX2, and the camera is ready to link with a transmitter.
2. Press and hold the power button of the transmitter for two seconds to power on.

3. Make sure that the transmitter is in Bluetooth linking mode when it is powered on. When the system status indicator of the transmitter is green, press and hold the record button for three seconds to switch to Bluetooth linking mode.
4. Press and hold the linking button of the transmitter for two seconds, the transmitter will start searching for nearby Bluetooth devices. During this process, the system status indicator of the transmitter blinks blue quickly.
5. When the transmitter is successfully linked with the camera, the system status indicator of the transmitter will be solid blue. Users can view the connection status according to the prompt on the screen. Press the linking button on the transmitter to start/stop recording while using the transmitter for audio.

-
- ☀️ • Osmo Pocket 3 is linked to the DJI Mic 2 Transmitter when purchased together as a combo. The transmitter can automatically link to the camera when powered on.
 - Osmo Pocket 3 can be linked with up to two DJI Mic 2 transmitters simultaneously.
-

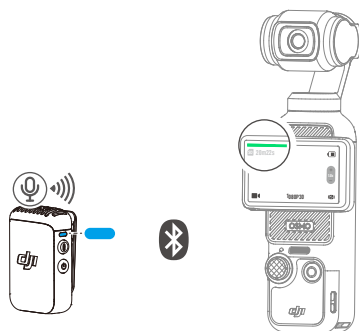

When the transmitter is linked to Osmo Pocket 3, swipe down from the top of the screen to enter the control menu. Tap the settings icon. Scroll down and tap Wireless Microphone to adjust the audio parameters of the transmitter.

Audio Parameters	Descriptions
Monitor Volume	Tap Monitor Volume to enable the volume slider. Slide the bar to adjust the volume of the external headphones for monitoring.
LED	When enabled, the Recording Status and System Status LEDs of the transmitter will blink normally. When disabled, the LEDs will turn off.
Vibration	Once enabled, the transmitter will vibrate in the scenarios listed below. <ul style="list-style-type: none"> • Power on: vibrates for a short period • Power off: vibrates for a long period • Start recording independently: vibrates for a short period • Stop recording independently: vibrates twice • Enable/disable Noise Cancelling: vibrates for a short period • Mute/unmute: vibrates for a short period

Audio-to-video Sync	When enabled, the transmitter will record audio files independently while the camera is recording video. The recorded audio format of the transmitter is 24-bit mono WAV. When recording for an extended period, the audio file will be separated automatically every 30 minutes. The transmitter stops recording when the storage is full.
Low Cut	When enabled, the transmitter will automatically filter low-frequency (below 150 Hz) sounds, thereby making recordings cleaner.
32-Bit Float Recording	When enabled, the transmitter can independently record audio files in 32-bit float, which provides larger dynamic range in post-production audio correction.
Format Transmitter 1/ Transmitter 2	Tap to format transmitter 1 or transmitter 2. Formatting will permanently delete all data on transmitter 1 or transmitter 2. Make sure to back up all required data before formatting.
Transmitter Version	Displays the firmware version of the transmitter.

Connecting to DJI Mic

Follow the steps below to connect the DJI Mic to the camera:

1. Power on the DJI Mic receiver and transmitter, and make sure the receiver and transmitter are linked.
2. Use the USB-C mobile phone adapter (included) to connect the receiver to the USB-C port on the camera. When connected, an input volume bar is displayed on the touchscreen of the camera.
3. Press the linking button on the transmitter to start recording while using the transmitter for audio. Press the linking button again to stop recording.

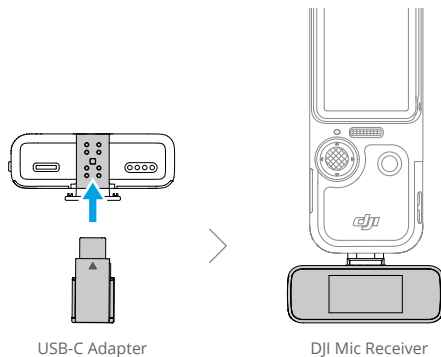

- The transmitter and the receiver are linked by default. Follow one of the methods below to link if the transmitter and receiver are disconnected.
 - a. Place the transmitter and the receiver in the charging case to link automatically.
 - b. Power on the transmitter and the receiver, press and hold the linking button on the transmitter, slide down on the screen of the receiver, select Settings and scroll through and tap Link Device to start linking. The status LED glows solid green to indicate linking was successful.

DJI Mimo App

When used with the DJI Mimo app, users can monitor the current camera view, set the camera parameters, and control the camera with a mobile device. DJI Mimo enables the user to get the most out of the gimbal camera with functions such as transferring, editing, and sharing files, and Wi-Fi livestreaming.

Downloading the DJI Mimo App

Search DJI Mimo in the app store, or scan the QR code to download and install.

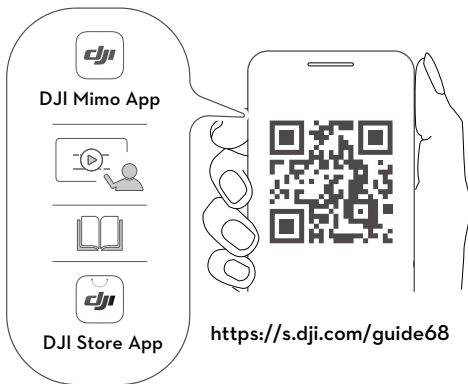



iOS 12.0 or above



Android 8.0 or above

Connecting to the DJI Mimo App

1. Power on Osmo Pocket 3.
2. Enable Wi-Fi and Bluetooth on the mobile device.
3. Launch DJI Mimo, tap  and follow the instructions to connect to Osmo Pocket 3.

-  • When Osmo Pocket 3 is linked with DJI Mic 2 Transmitter and working in the 2.4GHz Wi-Fi frequency band, DJI Mimo cannot connect to Osmo Pocket 3. Either change the Wi-Fi frequency band of Osmo Pocket 3 to 5.8GHz or disconnect DJI Mic 2 Transmitter before connecting to the DJI Mimo app.





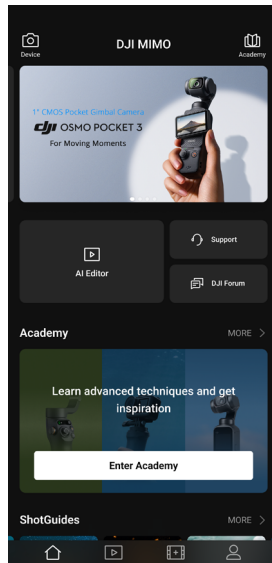

-  • If there is a problem when connecting to DJI Mimo, follow the steps below:
- a. Make sure both Wi-Fi and Bluetooth are enabled on the mobile device.
 - b. Make sure DJI Mimo is updated to the latest firmware version.
 - c. Swipe down from the top of the screen to enter the control menu, tap the settings icon, and select Wireless Connection > Reset Connection. The camera will reset all connections and Wi-Fi passwords.

DJI Mimo App Home Screen

Launch DJI Mimo and enter the home screen.



-  **Device:** tap to connect to Osmo Pocket 3. Once connected, DJI Mimo enters the camera view.

-  **Academy:** tap to watch tutorials and view manuals.
-  **AI Editor:** provides several templates for editing photos or videos.
-  **Home:** tap to return to the home screen.
-  **Album:** manage and view footage from a mobile device or DJI device.
-  **Editor:** tap to edit photos or videos on Osmo Pocket 3 or import them to and edit on a mobile device.
-  **Profile:** register or log in to a DJI account. Tap the setting icon to access more settings.

Camera View



The camera view differs depending on different shooting modes. This camera view is for reference only.

Tap on the touchscreen for focusing and spot metering. Drag-select on the touchscreen to enable ActiveTrack.

- Home:** tap to return to the home screen.
- Wi-Fi:** displays Wi-Fi connection.
- Battery Level:** displays current battery level of the gimbal camera.
- microSD Card Information:** displays either the remaining number of photos that can be taken or the video duration that can be recorded according to the current shooting mode.
- Camera Rotate:** tap to switch the camera between facing forward and backward.
- Gimbal Recenter:** tap to re-center the gimbal.
- Shutter/Record Button:** tap to take a photo or start recording a video.
- Gimbal Settings:** tap to set the gimbal modes and the rotation speed.

9. **Shooting Modes:** tap to change the shooting mode.
10. **Playback:** tap to preview and manage the shot footage on both the gimbal camera and the mobile device.
11. **Screen Mirroring:** tap to mirror the camera view.
12. **Virtual Joystick:** move the virtual joystick left and right to rotate the camera in the pan axis; move up and down to control camera tilt.
13. **Zoom:** displays the current zoom ratio. Place two fingers on the screen and move them apart to zoom in or pinch together to zoom out.
14. **Settings:** choose Basic or PRO mode for the selected shooting mode and set related parameters. More settings become available once PRO is enabled, such as FOV, Exposure, and White Balance. Different shooting modes have different settings and parameters.
15. **Glamour Effects:** tap to enable or disable Glamour Effects and adjust related parameters.
16. **Parameters Settings:** tap to set the parameters for each shooting mode, such as video resolution and frame rate.
17. **Shooting Parameters:** when in PRO mode, tap to set parameters such as EV, Shutter, and ISO.

Maintenance

Firmware Update

Use DJI Mimo to update the firmware of the device.

Ensure the battery level is above 15% before updating the firmware. Connect the device to DJI Mimo. If new firmware is available, DJI Mimo will display a prompt. Tap the prompt and follow the on-screen instructions to update the firmware. The update takes approximately 2 minutes.

Storing

Osmo Pocket 3 can be stored in the Osmo Pocket 3 Protective Cover or the Osmo Pocket 3 Carrying Bag.

Using the Osmo Pocket 3 Protective Cover

Power off the handheld gimbal camera. Store it in the protective cover with the touchscreen facing downward as shown in the illustration. It is unnecessary to detach the handle. The protective cover has dedicated storing locations for the Osmo Pocket 3 Black Mist Filter (A), the Osmo Pocket 3 Wide-Angle Lens (B), and the DJI Mic 2 Transmitter (C).

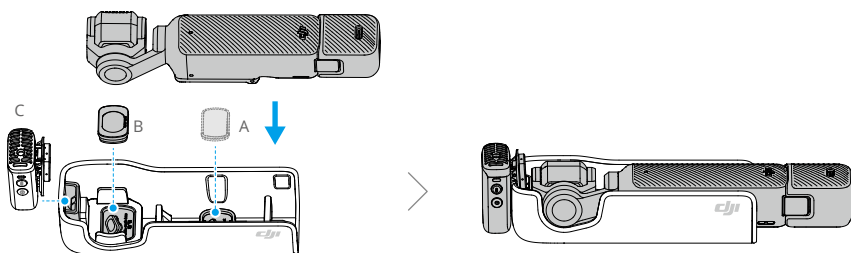

- ☀️ • To prevent unnecessary gimbal and screen damage, place Osmo Pocket 3 into the protective case correctly.
-

Using the Osmo Pocket 3 Carrying Bag

Power off the gimbal camera and store the devices in the carrying bag as shown. The carrying bag is specially designed to store the Osmo Pocket 3 Creator Combo and all of the accessories.

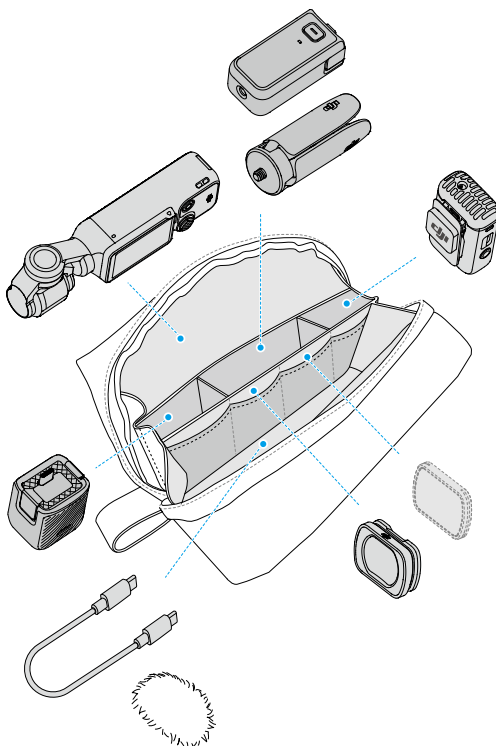

Usage Notices

1. Intricate components inside the device may be damaged upon impact and cause the gimbal to malfunction. Handle with care. Keep the product away from sand and dust to safeguard the device.
2. Make sure there is nothing obstructing the gimbal when the device is powered on.
3. DO NOT manually adjust the axis lock frequently to avoid causing the axis lock to malfunction.
4. The handheld gimbal camera is not water resistant. DO NOT spill any liquid on the handheld gimbal camera or use any liquid cleansers. Only use a soft dry cloth to clean the handheld gimbal camera.
5. DO NOT cover or touch the ventilation area of the handheld gimbal camera as it may become hot during use. When overheating, the camera will stop shooting.
6. DO NOT use the device in environments with high-amplitude vibrations such as installing on the handlebar of motorcycle or bike. Otherwise, the camera system and the gimbal can be damaged.
7. Slight friction between the screen frame and the body is a normal phenomenon and does not affect use when rotating the screen.
8. DO NOT expose the camera lens in an environment with laser beams, such as a laser show, in order to avoid damaging the camera sensor.

Optional Accessories (Not Included)

Osmo Pocket 3 Black Mist Filter

The Osmo Pocket 3 Black Mist Filter adopts a magnetic design and can be easily mounted to the camera lens. The 1/4 black mist filter can control highlight flares, lower image sharpness, and soften skin tones.

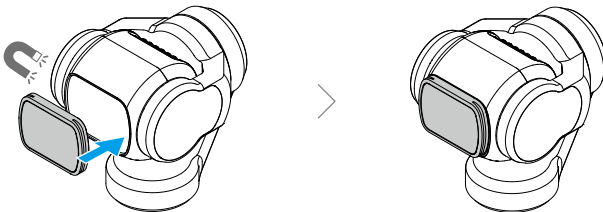

Osmo Pocket 3 Magnetic ND Filters Set

The Magnetic ND Filters Set includes ND16, ND64, and ND256 filters. The magnetic design facilitates easy attachment and detachment.

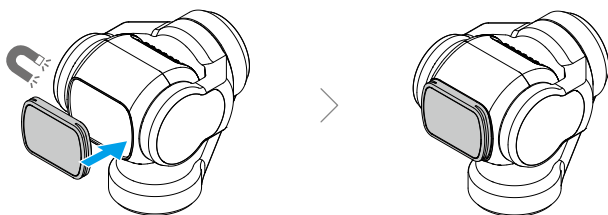

Osmo Pocket 3 Expansion Adapter

The expansion adapter can be used to install an action camera or other accessories using the cold shoe mount.

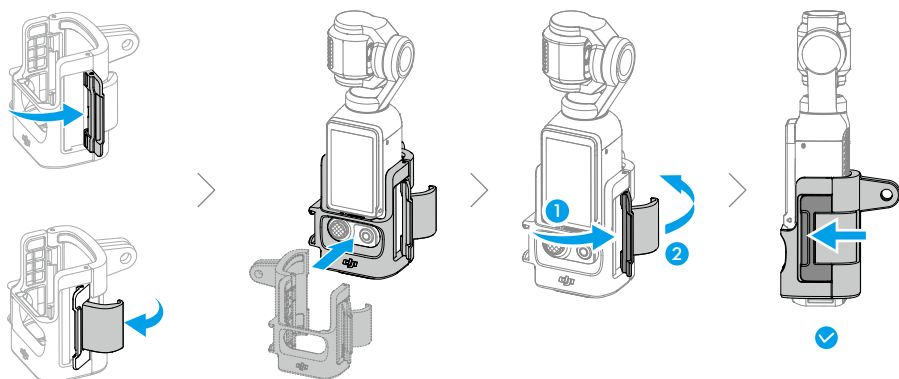
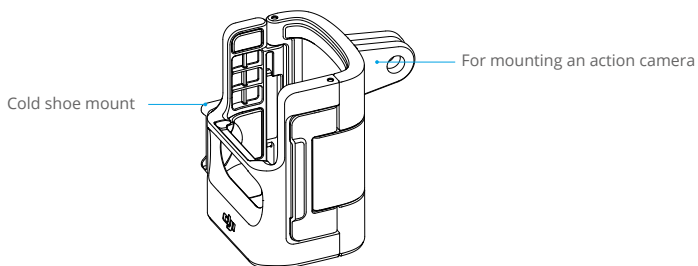

Specifications

General	
Dimensions	139.7×42.2×33.5 mm (L×W×H)
Weight	179 g
Number of Microphones	3
Touchscreen	Size: 2.0 inches Resolution: 314×556 Brightness: 700 nits
Supported SD Cards	microSD (up to 512 GB)
Recommended microSD Cards	SanDisk Extreme Pro 32GB V30 A1 UHS-I Speed Grade 3 Kingston Canvas Go!Plus 64GB UHS-I Speed Grade 3 Kingston Canvas Go!Plus 128GB UHS-I Speed Grade 3 Kingston Canvas React Plus 64GB UHS-II Speed Grade 3 Kingston Canvas React Plus 128GB UHS-II Speed Grade 3 Kingston Canvas React Plus 256GB UHS-II Speed Grade 3 Lexar Pro 256GB SDXC UHS-I V30 R160/W120 (1066x) Lexar Pro 512GB SDXC UHS-I V30 R160/W120 (1066x)
Gimbal	
Controllable Range	Pan: -235° to 58° Tilt: -120° to 70° Roll: -45° to 45°
Mechanical Range	Pan: -240° to 63° Tilt: -180° to 98° Roll: -220° to 63°
Max Controllable Speed	180.0°/s
Angular Vibration Range	±0.005°
Camera	
Sensor	1-inch CMOS
Lens	Equivalent Focal Length: 20 mm Aperture: f/2.0 Focus Range: 0.2 m to ∞
ISO Range	Photo: 50-6400 Video: 50-6400 Low-Light Video: 50-16000 Slow Motion: 50-6400
Electronic Shutter Speed	Photo: 1/8000-1 s Video: 1/8000 s to the limit of frames per second

Max Image Size	16:9, 3840×2160 1:1, 3072×3072
Zoom	Digital Zoom Photo: 3840×2160, 2x Video: 1080p, 4x; 2.7K, 3x; 4K, 2x UVC & Livestream: 1080p, 4x Slow Motion/Timelapse/Low-Light Video/Panorama: Not available
Still Photography Modes	Single Shot: Approx. 9.4 MP Countdown: Off/3/5/7 s Panorama: 180°, 3×3
Normal Video	4K (16:9): 3840×2160@24/25/30/48/50/60fps 2.7K (16:9): 2688×1512@24/25/30/48/50/60fps 1080p (16:9): 1920×1080@24/25/30/48/50/60fps 3K (1:1): 3072×3072@24/25/30/48/50/60fps 2160p (1:1): 2160×2160@24/25/30/48/50/60fps 1080p (1:1): 1080×1080@24/25/30/48/50/60fps 3K (9:16): 1728×3072@24/25/30/48/50/60fps 2.7K (9:16): 1512×2688@24/25/30/48/50/60fps 1080p (9:16): 1080×1920@24/25/30/48/50/60fps
Slow Motion	4K: 3840×2160@100/120fps 2.7K: 2688×1512@120fps 1080p: 1920×1080@120/240fps
Hyperlapse	4K/2.7K/1080p@25/30fps: Auto/×2/×5/×10/×15/×30
Timelapse	4K/2.7K/1080p@25/30fps Intervals: 0.5/1/2/3/4/5/6/8/10/15/20/25/30/40/60 s Duration: 5/10/20/30 mins, 1/2/3/5/∞ hours
Motionlapse	4K/2.7K/1080p@25/30fps Intervals: 0.5/1/2/3/4/5/6/8/10/15/20/25/30/40/60 s Duration: 5/10/20/30 mins, 1/2/3/5 hours Supports setting four positions
Low-Light Video	4K (16:9): 3840×2160@24/25/30fps 1080p: 1920×1080@24/25/30fps
Max Video Bitrate	130 Mbps
Supported File System	exFAT
Photo Format	JPEG/RAW
Video Format	MP4 (H.264/HEVC)
Built-in Storage Capacity	The camera does not have built-in storage, but storage capacity can be expanded by inserting a microSD card.
Audio Output	48 kHz 16-bit; AAC
Battery	
Type	LiPo
Capacity	1300 mAh
Energy	10.01 Wh

Voltage	7.70 V
Operating Temperature	0° to 40° C (32° to 104° F)
Charging Temperature	5° to 45° C (41° to 113° F)
Operating Time	166 mins ^[1]
Charging Time	16 mins to 80%; 32 mins to 100% ^[2]
Connection	
Wi-Fi Operating Frequency	2.4000-2.4835 GHz 5.150-5.250 GHz 5.725-5.850 GHz
Wi-Fi Protocol	802.11 a/b/g/n/ac
Wi-Fi Transmitter Power (EIRP)	2.4 GHz:< 23 dBm (FCC), < 20 dBm (CE/SRRC/MIC) 5.1 GHz:< 23 dBm (FCC/SRRC), < 20 dBm (CE) 5.8 GHz:< 23 dBm (FCC/SRRC), < 14 dBm (CE)
Bluetooth Operating Frequency	2.4000-2.4835 GHz
Bluetooth Transmitter Power (EIRP)	< 14 dBm
Bluetooth Protocol	BLE 5.2, BR/EDR

[1] Tested at room temperature (25° C/77° F) and 1080p/24fps (16:9), with Wi-Fi off and screen off. This data is for reference only.

[2] Tested in a laboratory environment with the DJI 65W PD charger (sold separately).

WE ARE HERE FOR YOU



Contact
DJI SUPPORT

This content is subject to change.



<https://www.dji.com/osmo-pocket-3/downloads>

If you have any questions about this document, please contact DJI by sending a message to DocSupport@dji.com.

DJI and OSMO are trademarks of DJI.
Copyright © 2023 DJI OSMO All Rights Reserved.