

1 2 3 4 5 6

A

B

C

D

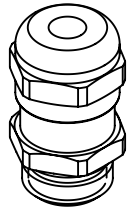
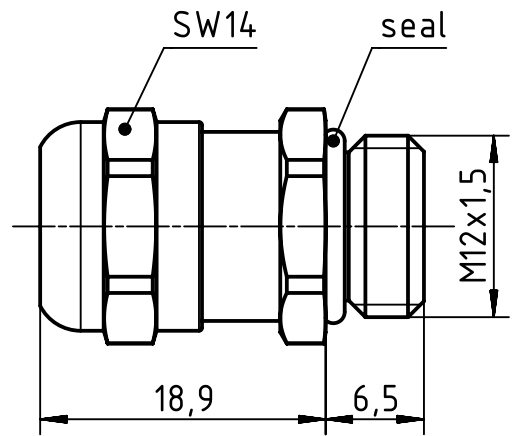
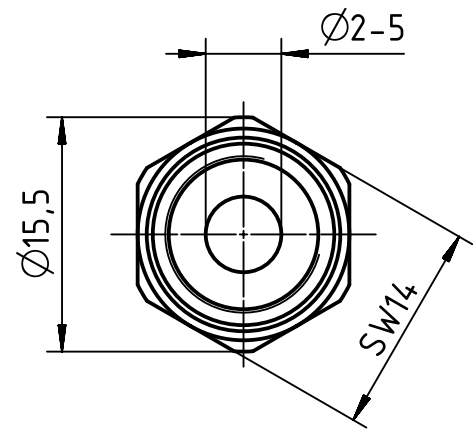

	All rights reserved Department EL PD HARTING Electric GmbH & Co. KG D-32339 Espelkamp	All Dimensions in mm Original Size DIN A4	Scale 2:1	Free size tol.		Ref.	
		Created by WULF	Inspected by 103979	Standardisation GARSKE	Date 2020-04-22	State Final Release	
		Title Han CGM-M M12x1,5 D. 2-5mm				Doc-Key / ECM-Nr. 100779369/UGD/002/B 500000167621	
		Type TB	Number 19 00 000 5027			Rev. B	Page 1/1