

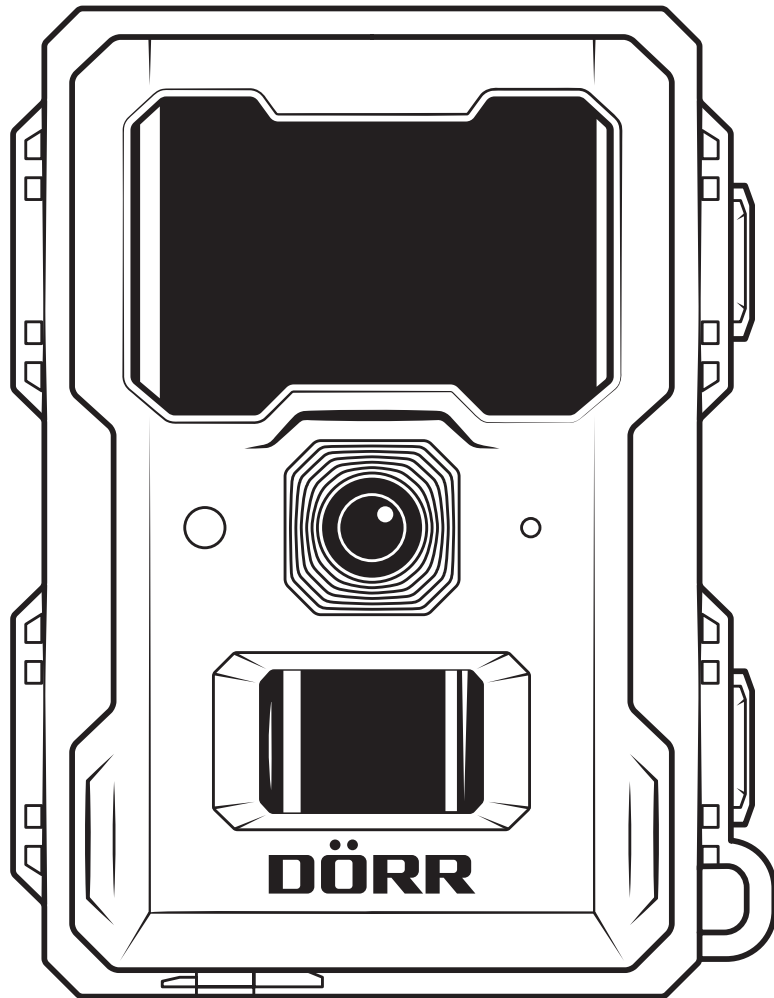



DÖRR

SURVEILLANCE CAMERA

GB INSTRUCTION MANUAL



SNAPSHOT MINI 5.0 PRO

INDEX	PAGE
01  SAFETY HINTS	3
02  SAFETY HINTS FOR BATTERIES	4
03 PRIVACY POLICY	4
04 NOMENCLATURE	4
05 ILLUSTRATION OF PARTS	5
06 FIRST COMMISSIONING	6
06.1 Inserting the batteries	6
06.2 Alternative power supplies	6
06.3 Inserting the SD/SDHC/SDXC Memory Card	6
06.3.1  IMPORTANT SDXC Memory Cards 64 GB & 128 GB	6
07 OPERATION	7
07.1 Overview home screen	7
07.2 All basic factory settings	7
07.3 Main Menus	7
07.4 Menu navigation	7
08 SETTINGS & FUNCTIONS	8
08.1 Main Menu CAM	8
08.2 Main Menu PIR	9 - 10
08.3 Main Menu SYS	11 - 12
08.4 Quick view of settings	12
09 TEST RECORDINGS / VIEW RECORDINGS	13
10 MOUNTING / DIRECTING / ACTIVATING	13
10.1 Mounting and directing the camera	13
10.2 Turn on camera and start surveillance	13
10.3 Notes for mounting the camera	13
10.3.1 PIR Sensor	13
10.3.2 Light conditions	13
10.3.3 Weather protection	14
11 OPTIONAL ACCESSORIES	14
11.1 Optional mounting accessories	14
11.2 Optional anti-theft devices	14
12 CLEANING AND STORAGE	14
13 SCOPE OF DELIVERY	15
14 TECHNICAL SPECIFICATIONS	14
15 DISPOSAL, CE MARK	16
15.1 Disposal of batteries/accumulators	16
15.2 WEEE Information	16
15.3 Disposal of the packaging	16
15.4 RoHS Conformity	16
15.5 CE Mark	16

THANK YOU very much for choosing a quality product by DÖRR.

Please read the instruction manual and the safety hints carefully before using the device for the first time.

Keep the operating instructions together with the device for reference. If other people use this device, provide them with these instructions. If you sell the unit, this manual forms an integral part of the device and must be supplied with it.

DÖRR is not liable for damage caused by improper use or failure to observe the operating and safety instructions.

In the event of damage caused by improper handling or by external influence, the guarantee or warranty claim becomes void. Any manipulation, structural modification of the product or opening of the housing by the user or an unauthorised third party shall be considered improper handling.

01 | ⚠ SAFETY HINTS

- ⚠ **This device is not a toy! To prevent accidents and suffocation keep the device, the accessories and the packing materials away from children and pets.**
- ⚠ People with physical or cognitive disabilities should use the camera with supervision.
- ⚠ People with cardiac pacemakers, defibrillators or any other electrical implants should maintain a **minimum distance of 30 cm**, as the device generates magnetic fields.
- Your camera is fitted with a **weatherproof housing according to protection class IP66** (dust and jet waterproof) so that the camera can be used outdoors. Nevertheless, protect the camera from extreme weather conditions and direct sunlight.
- **Caution! Make sure to use only fresh Mignon AA LR6 1.5V Alkaline Manganese batteries or rechargeable NiMH batteries of the same type and brand. Never combine Alkaline Manganese batteries with NiMH batteries! When inserting the batteries please respect the correct polarity (+/-).** Please remove batteries when device is not in use for a longer period.
- **Only use SD/SDHC memory cards from 8GB to 32GB (SDXC 64GB to max. 128GB see instruction manual chapter 08.3). Using a micro SD card in combination with an adapter may lead to malfunctions.**
- Do not drop the camera onto a hard surface. Do not use the camera if it has been dropped. In this case a qualified electrician should inspect the camera before you use it again.
- Do not attempt to repair the device by yourself. **Risk of electrical shock!** When service or repair is required, contact qualified service personnel.
- Do not open the camera housing (except the housing lid and the battery compartment) – the warranty will become void. The housing may only be opened by qualified DÖRR GmbH staff.
- LED bulbs can only be replaced by qualified DÖRR GmbH staff.
- Do not use the camera nearby devices that generate strong electromagnetic fields.
- Avoid touching the camera lens with your fingers.
- Protect the camera against extensive dirt. Never use aggressive cleansing agents or benzine to clean the camera. We recommend a soft, slightly damp microfiber cloth to clean the outer parts of the camera and the camera lens. **Make sure to remove batteries before cleaning.**
- Store the camera in a dust-free, dry and cool place when not in use.
- If the device is defective or without any further use, dispose of the device according to the Waste Electrical and Electronic Equipment Directive WEEE. For further information, please contact your local authorities.

02 | SAFETY HINTS FOR BATTERIES/ACCUMULATORS

Only use high-quality batteries or accumulators of popular brands. **When inserting the batteries or accumulators, please respect the correct polarity (+/-).** Do not insert batteries of different types and always replace all batteries at the same time. **Never combine Alkaline Manganese batteries with NiMH batteries!** Do not combine used batteries with fresh batteries. Please remove batteries/accumulators when device is not in use for a long period of time. **Do not throw the batteries/accumulators into fire, do not short-circuit and do not disassemble them! Never charge non-rechargeable batteries - risk of explosion!** Remove empty batteries immediately from the device to avoid the leaking of battery acid. Remove leaking batteries from the device immediately. Clean the contacts before inserting fresh batteries. **Risk of battery acid burn! In case of contact with battery acid, rinse the affected area immediately with water and contact a doctor. Batteries can be dangerous to life if swallowed. Keep batteries/accumulators away from small children and pets.** Do not dispose of batteries in household waste (see also chapter „Disposal of Batteries/ Accumulators“).

03 | PRIVACY POLICY

In every country, legal data protection rules apply. As these rules may vary per country, please contact the appropriate authorities to learn about the latest privacy policy in your country. In any case kindly note:

- **Do not observe public areas such as sidewalks, roads, parking lots etc.**
- **Never observe your staff.**
- **Respect the general right of privacy.**
- **Do not publish pictures showing individuals without having their permission. Do not publish pictures showing identifiable automobile license plates.**
- **Make aware of the observed areas with a sign and inform your neighbours and visitors if necessary.**

04 | NOMENCLATURE

- 01 Infrared LEDs
- 02 LED indicator/light sensor
- 03 Motion detector (PIR sensor)
- 04 Camera lens
- 05 Tension lock
- 06 Microphone
- 07 Eyelet for U-lock (lock optional)
- 08 LCD camera display
- 09 MENU button
- 10 OK button
- 11 Slide control (OFF/SETUP/ON)
- 12 Navigation buttons
- 13 Battery compartment
- 14 USB-C port
- 15 DC 12V connection
- 16 1/4" thread mount
- 17 Eyelets for mounting strap
- 18 Eyelets for cable lock (lock optional)
- 19 SD card slot
- 20 Mounting strap

05 | ILLUSTRATION OF PARTS

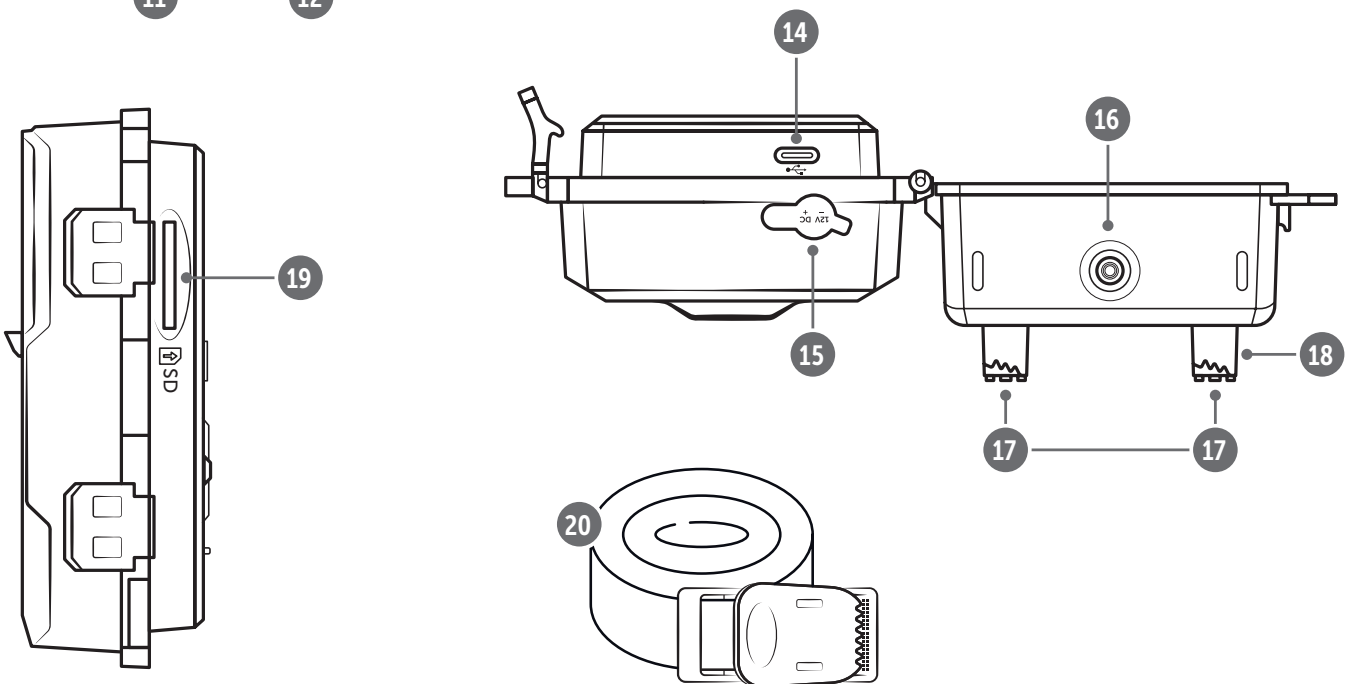
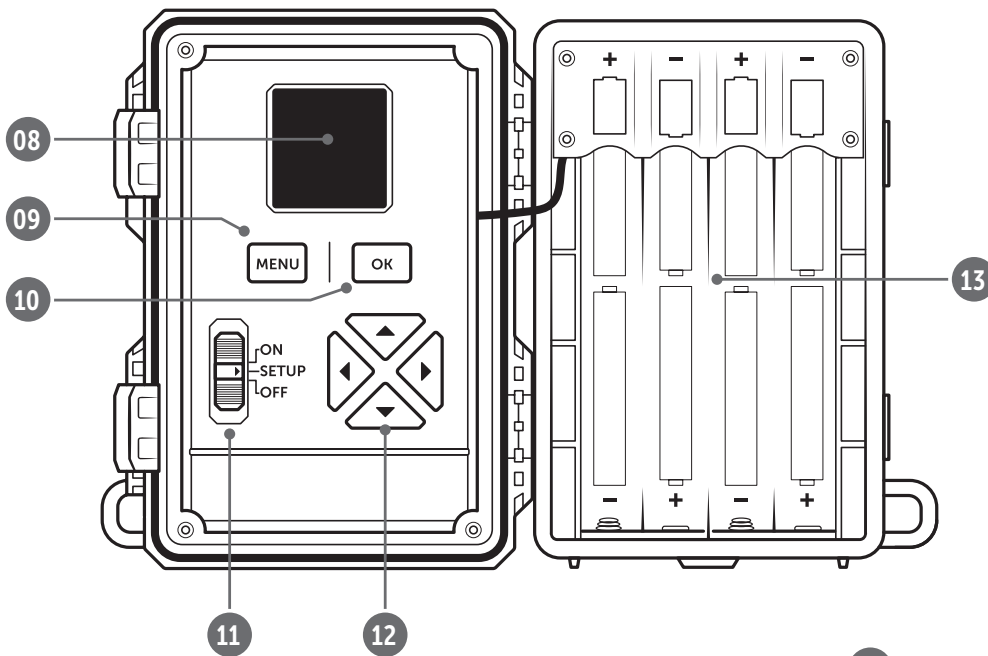
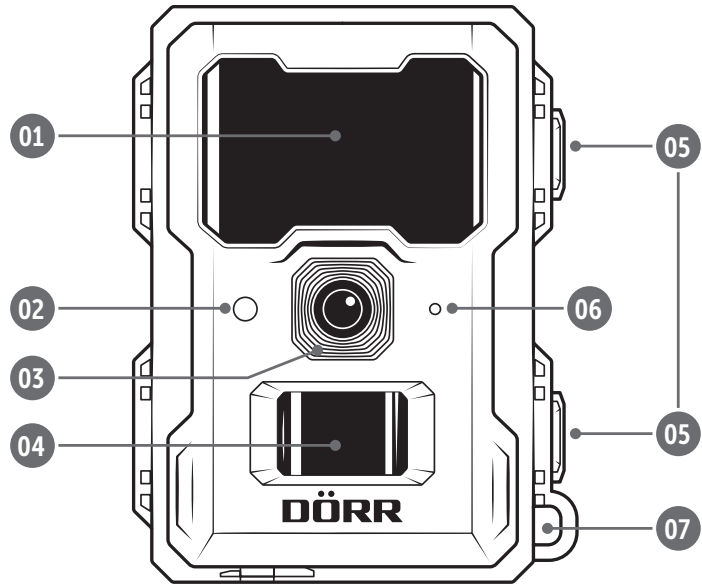

06 | COMMISSIONING

⚠ CAUTION

To avoid camera damages, make sure that camera is switched off (slide control 11 = OFF) for the following steps!

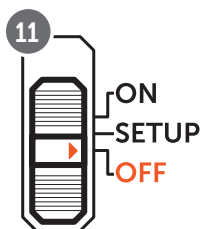

06.1 Inserting the batteries

⚠ CAUTION

Make sure to use only fresh Mignon AA LR6 1.5V Alkaline Manganese batteries or rechargeable NiMH batteries of the same type and brand. Never combine Alkaline Manganese batteries with NiMH batteries! When inserting the batteries please respect the correct polarity (+/-). Please remove batteries when device is not in use for a longer period.

Open the camera releasing the lateral tension locks (05). Make sure that the slide control (11) is on position **OFF**. Insert **8 pcs AA 1,5V batteries** (not included) into the battery compartment (13). **Respect correct polarity (+/-)**.

▶ NOTICE

To ensure exact indication of battery status when operating the camera with NiMH rechargeable batteries, please select NiMH in the camera menu „Battery Type“ located in camera register „SYS“ (see chapter 08.3).

06.2 Alternative power supplies

Use the **DÖRR solar panel with internal Lithium Ion battery 1500 mAh** for a sustainable and extended runtime. Optionally available in our **DÖRR webshop**:

DÖRR Solar Panel Li-1500 12V/6V
www.doerr-outdoor.de/204446

Alternatively, the camera can be operated with an **external 12V battery** in conjunction with our **DÖRR battery cable**. All optionally available in our **DÖRR webshop**:

Lead Battery 12V/12Ah

www.doerr-outdoor.de/204351

DÖRR Battery Cable 2m with flat plug

www.doerr-outdoor.de/204364

Both the solar panel and an external battery need to be plugged-in to the cameras DC 12V port (15). Any inserted batteries do not need to be removed when using external power supplies. The camera automatically reverts to the inserted batteries as soon as the external power supply is disconnected.

06.3 Inserting the SD/SDHC/SDXC memory card

▶ NOTICE

Only use SD/SDHC/SDXC memory cards from 8GB to max. 128GB. Using a micro SD card in combination with an adapter may lead to malfunctions. Make sure that the SD card is formatted and unlocked:

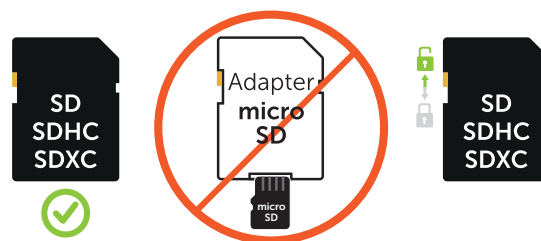

06.3.1 SDXC memory cards 64 GB & 128 GB

⚠ IMPORTANT

SDXC Speicherkarten 64 GB & 128 GB

Due to their standard formatting, SDXC memory cards with 64 GB and 128 GB must be formatted with the camera before use. How to format the SDXC card with the camera, please read chapter 08.3.

Insert the SD/SDHC/SDXC memory card (not included) with the **label facing upwards** into the SD card slot (19) until it snaps into place.

07 | OPERATION

07.1 Overview home screen

Switch the slide control (11) to the middle position **SETUP**.

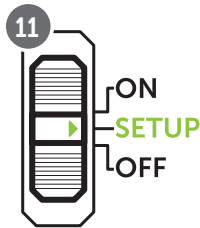

After the DÖRR Logo the LCD display (08) shows the basic factory settings:



	Camera is in single photo mode
5M	Resolution 5 Megapixel
	Battery level
01-01-2024 00:00:00	Date/time
0.0GB/14.7GB	Used/Free space (Example with 16GB SDHC card)

07.2 All basic factory settings

CAM	Camera mode:	Photo
	Photo settings:	Resolution: 5 M
		Multi Shot: 1 photo
		Flash Power: High
PIR	Trigger mode:	PIR Sensor ON
	PIR Sensitivity:	Level 7
	PIR Delay:	Off
	Time Lapse:	Off
	Timer 1 + 2:	Off
SYS	Language:	German *
	Password:	Off
	Battery Type:	Alkaline
	Overwrite SD:	On

* The camera menu language is factory set to **GERMAN**. To change the menu language, please go to **chapter 08.3**.

07.3 Main Menus

To adjust the settings for your purposes, switch the slide control (11) to the middle position **SETUP** and press the menu button (09) . The **3 main menus** appear in the top left of the LCD display (08). The selected main menu is **highlighted in yellow**:



Main menu CAM

Here you can adjust the **camera settings**. You can see the different settings in **chapter 08.1**.



Main menu PIR

Here you can adjust the **trigger settings**. You can see the different settings in **chapter 08.2**.



Main menu SYS

Here you can set the **date/time, language, password etc.** You can see the different settings in **chapter 08.3**.

07.4 Menu navigation

- Press the navigation buttons (12) or to select the desired submenu. The selected submenu is **highlighted in yellow**:

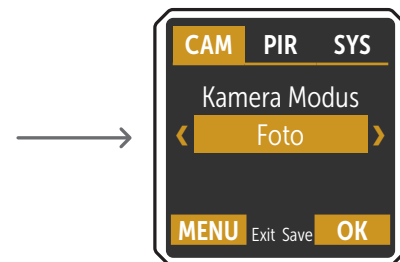

- Use the navigation buttons (12) or to select the desired setting.
- To save your settings press the OK button (10) .
- Press the menu button (09) to return to the home screen.

08.1 Main Menu CAM

Cam Mode



< Photo > Selection **< Photo >**. The camera takes pictures according to your further, subsequent photo settings.

Image Size	Select the desired image resolution .	< 5M >	5 MP (3072 x 1728)
		< 3M >	3 MP (2304 x 1280)
Multi Shot	Select the number of images to be taken upon movement or triggering..	< 1 Photo >	
		< 2 Photos >	
		< 3 Photos >	
Flash Power	Select the desired flash range .	< Low >	up to approx. 8 m
		< High >	up to approx. 20 m

Cam Mode



< Video > Selection **< Video >**. The camera makes videos according to your further, subsequent video settings.

Video Size	Select the desired video format .	< HD-720P >	HD (1280 x 720)
		< FHD-1080P >	Full HD (1920 x 1080)
Video Length	Select the desired video length .	< Sec >	5 - 59 seconds
Flash Power	Select the desired flash range .	< Low >	up to approx. 8 m
		< High >	up to approx. 20 m

Cam Mode



< Photo+Video > Selection **< Photo+Video >**. The camera first takes a photo (or photos) and then records a video according to your other subsequent settings for photos and videos.

Image Size	Select the desired image resolution .	< 5M >	5 MP (3072 x 1728)
		< 3M >	3 MP (2304 x 1280)
Multi Shot	Select the number of images to be taken upon movement or triggering..	< 1 Photo >	
		< 2 Photos >	
		< 3 Photos >	
Video Size	Select the desired video format .	< HD-720P >	HD (1280 x 720)
		< FHD-1080P >	Full HD (1920 x 1080)
Video Length	Select the desired video length .	< Sec >	5 - 59 seconds
Flash Power	Select the desired flash range .	< Low >	up to approx. 8 m
		< High >	up to approx. 20 m

PIR Sensor

< ON >

< OFF >

Selection < ON > The **Passive Infrared Sensor (PIR)** triggers upon motion and temperature changes recognised within the detection range.

PIR Sensitivity

Adjust the **sensitivity of the motion detector**.

< Level 1 >

< Level 2 >

< Level 3 >

< Level 4 >

< Level 5 >

< Level 6 >

< Level 7 >

< Level 8 >

< Level 9 >

Select when camera triggers too often upon environment influences, e.g. falling branches or strong sunlight.

The camera recognises even smallest motion and temperature changes.

PIR Delay

Set a pause for the PIR Sensor. This setting prevents the camera from taking too many images/videos.

< OFF >

< ON >

Example with setting 5 minutes:

After triggering, the camera sets the PIR inactive for 5 minutes. After the time set the PIR sensor will be active again.

Possible delay: **min. 05 seconds to max. 24 hours (Input 23:59:59)**

After selection < ON > and pressing the OK button (10) another window opens for entering the time duration:

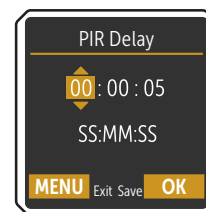

Use the buttons (12) ▲ or ▼ to select the **hours**. Use the button ► to enter the next input field. Select the **minutes and seconds** accordingly. Confirm your entry with the **OK button** (10).

Time Lapse

The camera triggers according to the specific time set, **independently from the PIR detector**.

< OFF >

< ON >

Example with setting 01:00:00:

The camera triggers every hour independently from motion recognition.

Possible time interval: **min. 05 seconds to max. 24 hours (Input 23:59:59)**

After selection < ON > and pressing the OK button (10) another window opens for entering the time interval:

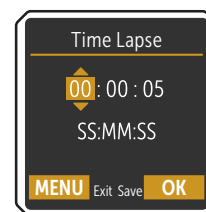

Use the buttons (12) ▲ or ▼ to select the **hours**. Use the button ► to enter the next input field. Select the **minutes and seconds** accordingly. Confirm your entry with the **OK button** (10).

Timer 1

Set a **fixed working time frame in which the camera is active**. Outside of this time, no recordings are made or movements are registered.

Example with setting 2:00 – 5:00:
Camera is only active between 2:00 and 5:00 a.m.

If you select the **< OFF >** function in this menu item, the camera works 24 hours a day. You can set up to **2 working times** per day.

< OFF >

Selection **< OFF >** Camera works 24 h.

< ON >

After selection **< ON >** and pressing the **OK button (10)** another window opens for entering the start and end time:



Use the buttons (12) ▲ or ▼ to select the **hours**. Use the button ► to enter the next input field. Select the **minutes**. Confirm your entry with the **OK button (10)**.

Timer 2

Set a **fixed working time frame in which the camera is active**. Outside of this time, no recordings are made or movements are registered.

Example with setting 2:00 – 5:00:
Camera is only active between 2:00 and 5:00 a.m.

If you select the **< OFF >** function in this menu item, the camera works 24 hours a day **or according to your settings for timer 1**.

< OFF >

Selection **< OFF >** Camera works 24 h.

< ON >

After selection **< ON >** and pressing the **OK button (10)** another window opens for entering the start and end time:



Use the buttons (12) ▲ or ▼ to select the **hours**. Use the button ► to enter the next input field. Select the **minutes**. Confirm your entry with the **OK button (10)**.

Date & Time

Set the **date** and **time**.

Date format: **DD / MM / YYYY**

Time format: **24-hours**

< Enter >

After selection < **Enter** > and pressing the **OK button (10)** another window opens for entering the date and time:

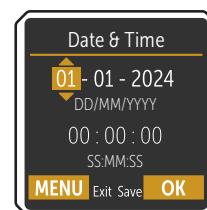

Use the buttons (12) ▲ or ▼ to select the **day**. Use the button ► to enter the next input field. Select the **month** and **year** accordingly.

Use the ► button to access the time input field. Use the buttons (12) ▲ or ▼ to select the **hour**. Use the button ► to enter the next input field. Set the **minutes** and **seconds** accordingly. Confirm your entry with the **OK button (10)**.

Language

Select the desired **language** for the camera menu.

< Deutsch > *

* pre-installed

< English >

< Français >

< Italiano >

< Español >

< Čeština >

< Dansk >

< Suomi >

< Magyar >

< Nederlands >

< Svenska >

Password

The camera can be **password** protected against unauthorized use. When the password function is activated, the password will be requested immediately after the camera is switched on.

< OFF >

No password request when switching on.

< ON >

After selecting < **ON** > and pressing the **OK button (10)**, another window opens for entering a 6-digit numerical code:

Default password:

< 0 0 0 0 0 >

▶ **NOTICE**

We recommend writing down the password in a safe place, as the camera can no longer be operated if the password is lost.

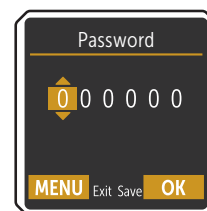

Use the buttons (12) ▲ or ▼ to select the **number**. Use the button ► to enter the next input field. Confirm your entry with the **OK button (10)**.

08.3 Main Menu SYS

Battery Type	To ensure an accurate indication of the battery status, please select whether you have inserted alkaline batteries or Ni-MH batteries into the camera.	<input type="radio"/> Alkaline > * <input type="radio"/> Ni-MH >	* pre-installed
Overwrite SD	<p>When selecting < OFF > If the SD card is full, the camera stops recording until the card is changed or formatted.</p> <p>When selecting < ON > If the SD card is full, the camera overwrites the oldest files.</p>	<input type="radio"/> OFF > <input type="radio"/> ON >	Camera stops recording Camera overwrites oldest files
FW Update	<p>Only for DÖRR service work!</p>	<input type="radio"/> YES >	By pressing the menu button (09) you exit this function and return to the start screen.
Format SD	<p>This function deletes all files from the SD card and re-formats the memory card.</p> <p>▶ NOTICE Make sure that you do not need the files on the SD card anymore, before you start formatting!</p>	<input type="radio"/> YES >	By pressing the menu button (09) you exit this function and return to the start screen.
Reset	<p>Restoring of Factory Settings This function restores all settings to initial factory settings (except date and time).</p>	<input type="radio"/> YES >	By pressing the menu button (09) you exit this function and return to the start screen.

08.4 Quick view of settings

To quickly view and check your settings, set the slide control (11) to the **SETUP** position.

Then press the button (12) . An overview of your settings appears in the LCD display:



Use the buttons (12)  or  to scroll through the overview.

09 | TEST RECORDINGS / VIEW RECORDINGS

In **SETUP** mode (slide control 11 on position SETUP), a test photo, test video or test photo+video can be released **according to your settings made in the main menu CAM camera mode**.

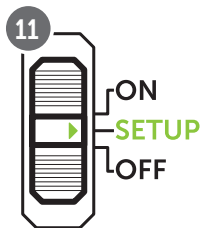

To trigger the test recording, press the OK button (10).

If the test recording was successful, the following appears in the display (depending on the camera mode set):



The recordings can be viewed with the help of a laptop or PC. You have 2 options for this:

1. Connect the camera directly to the computer using an optional **USB-C data cable**. To do this, plug the USB-C data cable into the USB-C socket (14) of the camera and connect it to the USB port of your computer.
2. Remove the memory card from the camera and read it out with an **external card reader** (optionally available).

10 | MOUNTING / DIRECTING / ACTIVATING

10.1 Mounting and directing the camera

Pull the **supplied mounting strap** (20) through the eyelet (17) on the backside of the camera. Mount the camera to a tree, pole or any other suitable object. Do not fix the belt finally at this stage.

We recommend placing the camera at a height of **0.75 m to 1.00 m**. The optimal distance to the subject is between **3 and 10 m**. Larger distances are possible as well, but then the reliability of the motion sensor is no longer given. The camera lens (04) should now point to where the object is expected to show-up.

To verify your camera is hung up in a correct angle, we recommend

taking a view **test photos** (see **chapter 09**). The camera should be directed in a way that the object will appear in the centre of the picture. You may have to re-adjust the camera and take another test shot.

NOTICE

To change the camera angle you can use e.g. a small wooden wedge between camera and trunk. Please also note **chapter 11** with our extensive range of **accessories for installation and anti-theft protection**.

Once the camera position is correct, the mounting belt (20) can be tightened to hold the camera firmly. After successful assembly and test recording, switch the camera off (11 = **OFF**).

10.2 Turn on camera and start surveillance

In order to get the camera ready to work, move the slide control (11) to the position **ON** and close the camera housing. **After approx. 10 seconds**, the camera will be active. In case of movements detected, it takes pictures according to your settings.

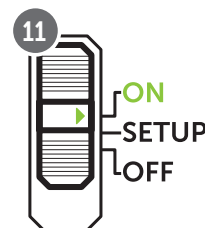

10.3 Notes for mounting the camera

10.3.1 PIR sensor

The PIR sensor triggers only under specific circumstances within a certain range. The capturing of objects strongly depends on temperature, vegetal cover, reflecting surfaces etc. Under perfect conditions the recognition range can be up to 20m. Usually, you may expect a range of 15 m. It may take a few attempts to find a good position for the camera. During photo test, be aware that animals are usually remarkably smaller than human beings. Animals might be below the PIR sensor detection range and not be captured.

10.3.2 Light conditions

Avoid direct backlight when mounting the camera. The lens should not point directly into the sun and camera should not be placed in shadow.

10.3.3 Weather protection

Although the camera is weatherproof and well-suited for outdoor use (dust and jet water protected according to IP66 protection class) we recommend mounting the camera in a secured place not facing the weather exposed side. Prevent the camera from driving

rain and constant exposure to sunlight. After a long period of humidity caused by rain or fog, the camera should be placed in a dry area for a few days.

11 | OPTIONAL ACCESSORIES

11.1 Optional mounting accessories

Our optional accessories such as the **patented DÖRR holding fixture in combination with the DÖRR universal adapter** are designed for fast and easy mounting of the camera at a tree, wall or other objects. The camera clicks into the holding fixture and is firmly held in place. The camera can be removed easily for a quick change of place of action. The ball head ensure a flexible direction of the camera. The fixture is rotatable by 360° and swivels up to 30° in all directions:

DÖRR Holding Fixture Multi for SnapShot

www.doerr-outdoor.de/204490 

DÖRR UNI-1 Universal Adapter for Holding Fixture

www.doerr-outdoor.de/204495 

11.2 Optional anti-theft devices

Pull a **padlock** (available as accessory) through the eyelet (07) to lock the camera housing:

DÖRR Combination Lock 3-digits small

www.doerr-outdoor.de/204454 

Use our **DÖRR cable lock** (available as accessory) and pull it through the eyelet for cable lock (18) on the backside of the camera to secure it against theft:

DÖRR Universal Cable Lock 1,80 m

www.doerr-outdoor.de/204452 

 Visit our web shop www.doerr-outdoor.de

for a great variety of surveillance camera accessories and get more information on our wide assortment of **hunting and outdoor items!**

12 | CLEANING AND STORAGE

Never use aggressive cleansing agents or benzine to clean the device. We recommend a soft, slightly damp microfiber cloth to clean the outer parts of the device. **Remove batteries before cleaning!** Store the device in a dust-free, dry and cool place. **This device is not a toy - keep it out of reach of children. Keep away from pets.**

13 | SCOPE OF DELIVERY

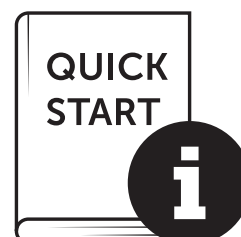
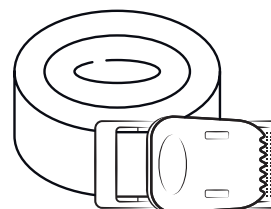
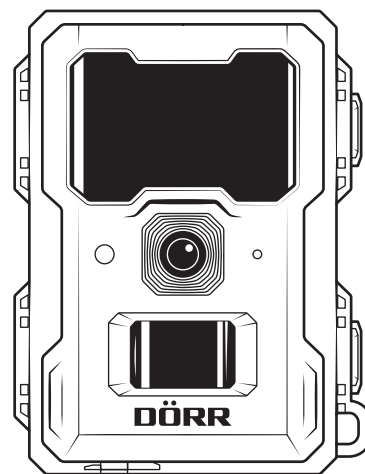

14 | TECHNICAL SPECIFICATIONS

Recording capability	Photo / Video with audio / Photo+Video with audio
Combined picture and video recording	Yes
Number of LEDs / LED Type	60 invisible infrared LEDs, 940nm
Flash range max. approx.	20 m
Detection range motion sensor approx.	20 m / 60°
Picture angle approx.	60°
Trigger speed PIR sensor approx.	0,5 - 0,6 s
Image sensor	3MP colour CMOS sensor
Aspect ratio	16:9
Picture resolution	3MP (2304x1280) / 5MP (3072x1728)
Video resolution	Full HD 1080P (1920x1080) / HD 720P (1280x720)
Video length	5 - 59 s
Digital picture format	JPEG
Digital video format	MP4
Mobile transmission	no
Display	1,4" TFT colour display
Playback on display	(only settings)
Lens	F = 2.0 / 60°
Multiple shots (pictures per release)	1 - 3 Photos
Delay PIR Sensor	5 seconds to 24 hours
Sensitivity PIR sensor	1 - 9 levels
Time frames per day	2
Time lapse function	Yes
Time stamp on image	Camera name, battery status, temperature (°F/°C), moon phase, date, time
Menu language	DE, GB, FR, ES, IT, CZ, DK, FI, HU, NL, SE
Password protection	Yes
Memory card	SD/SDHC from 8GB to 32GB (SDXC 64GB to max. 128GB see instruction manual) memory card not included
Thread mount 1/4"	Yes
Compatible with DÖRR Holding Fixture (Item-No. 204490)	Yes, with DÖRR Uni 1 adapter (Item No. 204495, optional)
Power supply	8x Mignon AA LR6 1.5V Alkaline batteries or equivalent NiMH rechargeable batteries (not included)
Operating voltage	DC 12V
Power consumption approx.	in operation 38-321mA by day, 45-722mA by night / standby 0.16mA
Runtime in standby mode approx.	up to 8 month with 8x AA batteries
Socket for external battery	Yes
USB port	USB-C
Ingress protection code	IP66
Operating temperature approx.	-20°C to +55°C
Storage temperature approx.	-25°C to +60°C
Relative humidity approx.	5% - 90%
Colour	camouflage/black
Dimensions approx.	9,3 x 12,5 x 7,5 cm
Weight without batteries approx.	256 g

DÖRR GmbH reserves the right to make technical changes without notice.

15 | DISPOSAL, CE MARKING

15.1 DISPOSAL OF BATTERY/ACCUMULATOR

Batteries and rechargeable batteries are marked with the symbol of a crossed-out waste bin. This symbol indicates that empty batteries or rechargeable batteries that can no longer be recharged must not be disposed of in household waste. Old batteries may contain harmful substances that can cause damage to health and the environment. As the end user, you are legally obliged to return used batteries (under German battery law, Section 11 Act Revising the Law of Waste-Related Product Responsibility for Batteries and Accumulators). You can return batteries free of charge after use at the point of sale or in your immediate vicinity (e.g. at municipal collection points or in shops). You can also return batteries to the seller by post.

15.2 WEEE INFORMATION

The WEEE (Waste Electrical and Electronic Equipment) Directive, which came into force as European law on 13 February 2003, led to comprehensive changes in the disposal of discarded electrical equipment. The primary purpose of this directive is to prevent e-waste while promoting reuse, recycling and other forms of reprocessing in order to reduce waste. The WEEE logo (dustbin) shown on the product and on the packaging indicates that the product must not be disposed of in normal household waste. You are responsible for delivering all discarded electrical and electronic equipment to appropriate collection points. Sorting waste for separate collection and sensible recycling of packaging waste helps to use natural resources more sparingly. Furthermore, e-waste recycling is a contribution to preserving our environment and thus also people's health. Further information on the disposal of electrical and electronic equipment, recycling and collection points can be obtained from local authorities, waste disposal companies, specialist retailers and the manufacturer of the device.

15.3 DISPOSAL OF THE PACKAGING

Dispose of the packaging by type. Give cardboard to the waste paper, foils to the collection of recyclables.

15.4 CONFORMITY WITH ROHS

This product complies with the European RoHS Directive on the restriction of the use of certain hazardous substances in electrical and electronic equipment and variations thereof.

15.5 CE MARK

The imprinted CE mark complies with the applicable EU standards

and indicates that the device meets the requirements of all EU directives applicable to this product.

DÖRR Surveillance Camera
SnapShot Mini 5.0 Pro
Item-No. **204501**

Made in China

DÖRR GmbH
Messerschmittstr. 1
D-89231 Neu-Ulm
Fon: +49 731 970 37 69
hello@doerr.gmbh
<https://doerr-outdoor.de>