

FEATURES

- Efficiency up to 96%, no need for heatsinks
- Pin-out compatible with LM78xx linears
- Compact package (L*W*H=11.5*7.55*10.2mm)
- Wide input range (5V - 40V)
- Short circuit protection, thermal shutdown
- Low ripple and noise
- IEC/EN62368-1 certified
- Positive to negative converter



Dimensions (LxWxH): 11.5 x 7.55 x 10.2mm (0.45 x 0.30 x 0.40 inch)
1.7g (0.037 lbs)

APPLICATIONS



SAFETY & EMC



DESCRIPTION

The R-78CK-0.5 is a non-isolated DCDC converter from RECOM. This 0.5 amp switching regulator is a compact and efficient solution with a wide input range of 5V to 40V. With up to 96% efficiency and no need for heatsinks, it saves space and energy while operating up to 100°C ambient temperature. Its pin-out is compatible with the LM78xx linear, making it easy to integrate into existing designs. The converter also features short circuit protection, thermal shutdown, and low ripple and noise, ensuring stable performance. It is certified by IEC/EN62368-1, making it a versatile solution for a wide range of applications. The fixed output voltages of 3.3, 5, 12, and 15V make the R-78CK particularly easy to use, and additional voltages are available upon request. The converter can also serve as a positive to negative converter, making it ideal for use in circuits that require a negative voltage source.

SELECTION GUIDE

Part Number	Input Voltage Range [VDC]	Output Voltage [VDC]	Output Current [mA]	Efficiency @ min. Vin [%]	Efficiency @ max. Vin [%]	Max. Capacitive Load ⁽¹⁾ [µF]
R-78CK3.3-0.5	5 - 40	3.3	500	91	72	2000
R-78CK5.0-0.5	6.5 - 40	5	500	94	79	1800
R-78CK12-0.5	15 - 40	12	500	96	89	560
R-78CK15-0.5	18 - 40	15	500	96	90	560

Note1: Max. Cap Load is tested at V_N= 24VDC and full resistive load

R-78CK-0.5 series

0.5Amp / SIP3 Single Output

BASIC CHARACTERISTICS (measured @ $T_{AMB} = 25^{\circ}C$, nom. V_{IN} , full load and after warm-up unless otherwise stated)

Parameter	Condition		Min.	Typ.	Max.
Input Under Voltage Lockout (UVLO)	R-78CK3.3-0.5	DC-DC ON		4.4VDC	
		DC-DC OFF		4.3VDC	
	R-78CK5.0-0.5	DC-DC ON		6.1VDC	
		DC-DC OFF		5.3VDC	
	R-78CK12-0.5	DC-DC ON		13.9VDC	
		DC-DC OFF		12.4VDC	
R-78CK15-0.5	DC-DC ON		16.7VDC		
	DC-DC OFF		15.3VDC		
Maximum Input Voltage Slew Rate ⁽²⁾					10VDC/ μ s
Input Current	R-78CK3.3-0.5			85mA	
	R-78CK5.0-0.5			120mA	
	R-78CK12-0.5			270mA	
	R-78CK15-0.5			330mA	
Quiescent Current				1mA	
Internal Operating Frequency				800kHz	
Minimum Load			0%		
Output Ripple and Noise ⁽³⁾	20MHz BW and full load			10% of V_{OUT}	

Note2: At higher slew rates or hard plugging, add 27 μ F E-Cap on +Vin, especially when Vin is greater than 18VDC

Note3: Measurements are made with a 10 μ F MLCC across output. (low ESR)

R-78CK3.3-0.5

Efficiency vs. Output Load

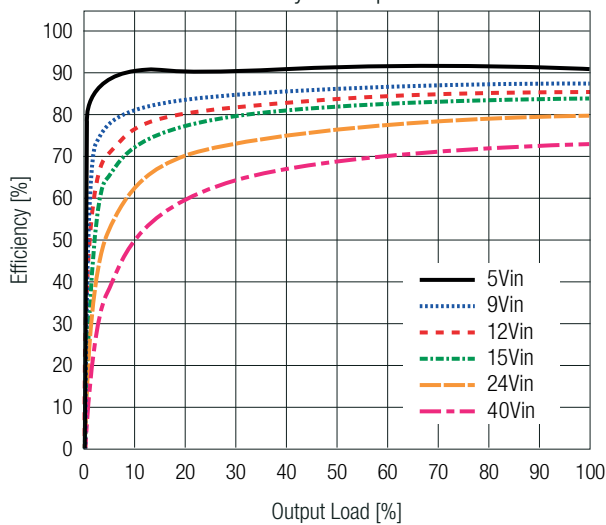

Power Dissipation vs. Output Load

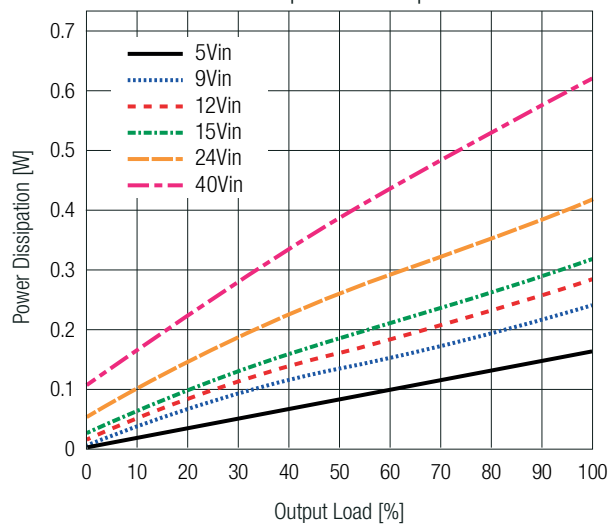

R-78CK5.0-0.5

Efficiency vs. Output Load

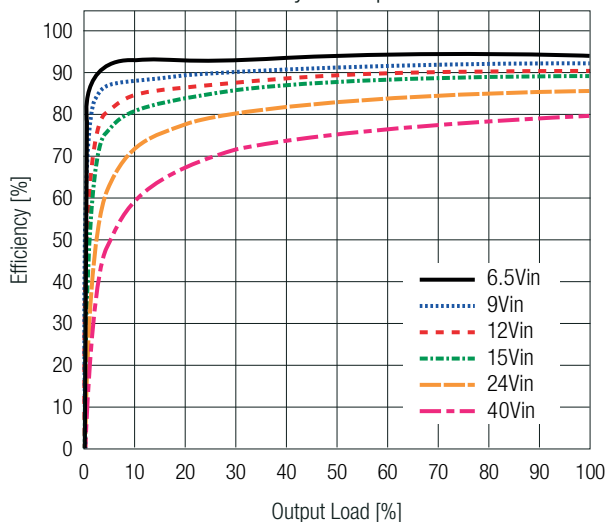

Power Dissipation vs. Output Load

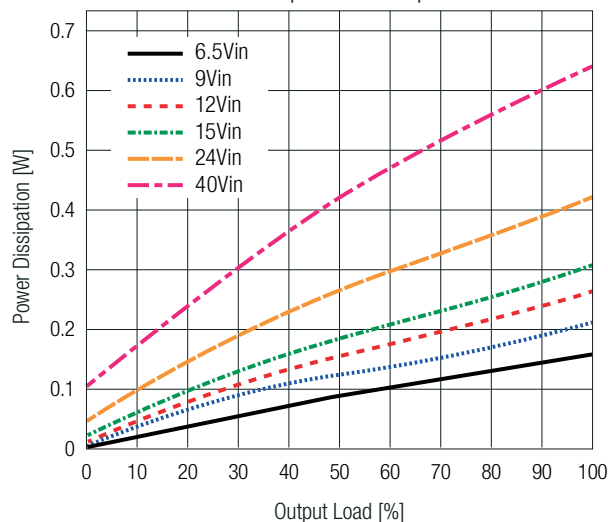

R-78CK-0.5 series

0.5Amp / SIP3 Single Output

BASIC CHARACTERISTICS (measured @ $T_{AMB} = 25^{\circ}C$, nom. V_{IN} , full load and after warm-up unless otherwise stated)

R-78CK12-0.5

Efficiency vs. Output Load

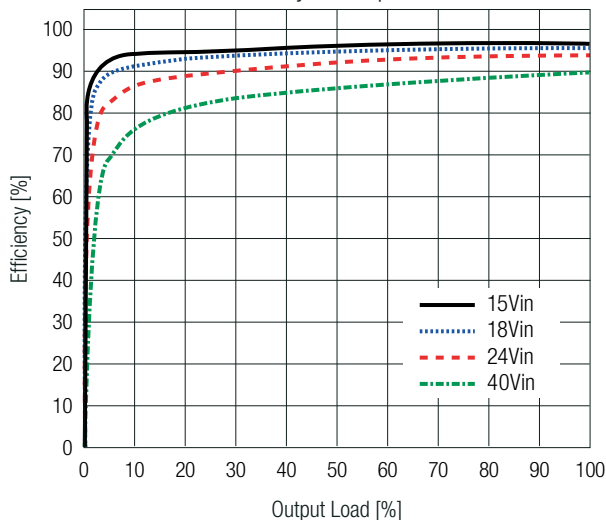

Power Dissipation vs. Output Load

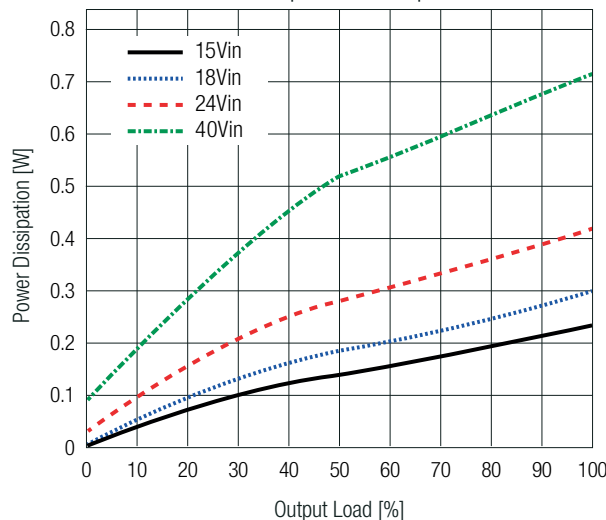

R-78CK15-0.5

Efficiency vs. Output Load

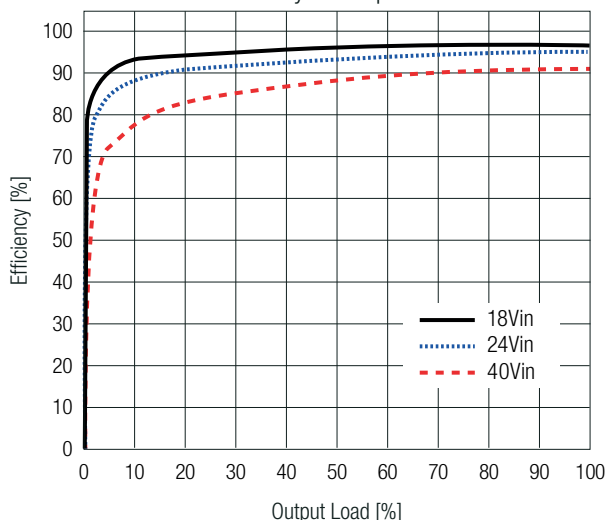

Power Dissipation vs. Output Load

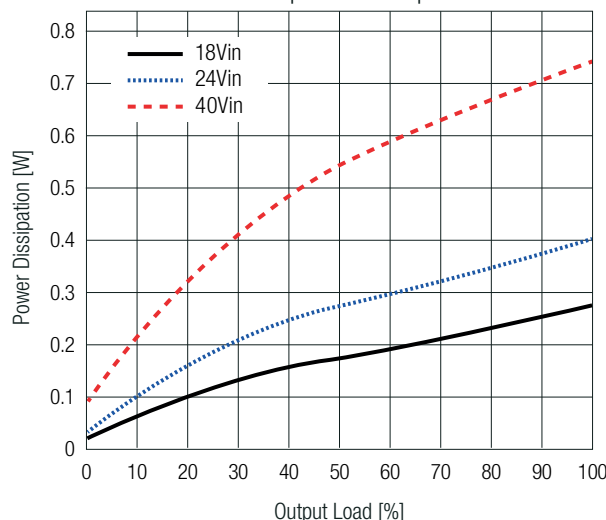

REGULATIONS

Parameter	Condition	Value
Output Accuracy		±3.0% typ.
Line Regulation	low line to high line, full load	±1.0% typ.
Load Regulation	0% to 100%	3.0% typ.

PROTECTIONS

Parameter	Condition	Value
Short Circuit Protection (SCP)		continuous, automatic recovery

ENVIRONMENTAL

Parameter	Condition	Value
Operating Temperature Range	refer to „Derating Graph“	-40°C to +100°C
Maximum Case Temperature		+110°C
Operating Altitude		5000m
Operating Humidity	non-condensing	95% RH max.
Polution Degree		PD2
Short Circuit Protection (SCP)		continuous, automatic recovery

ENVIRONMENTAL

Parameter	Condition		Value	
MTBF	according to MIL-HDBK-217F, G.B., $V_{IN} = 24VDC$	R-78CK3.3-0.5	$T_{AMB} = +25^{\circ}C$	5945×10^3 hours
			$T_{AMB} = +70^{\circ}C$	1958×10^3 hours
		R-78CK5.0-0.5	$T_{AMB} = +25^{\circ}C$	5136×10^3 hours
			$T_{AMB} = +70^{\circ}C$	2019×10^3 hours
		R-78CK12-0.5	$T_{AMB} = +25^{\circ}C$	5186×10^3 hours
			$T_{AMB} = +70^{\circ}C$	1719×10^3 hours
R-78CK15-0.5	$T_{AMB} = +25^{\circ}C$	5924×10^3 hours		
	$T_{AMB} = +70^{\circ}C$	2207×10^3 hours		

Derating Graph

(@ Chamber and natural convection 0.1m/s, over V_{in})

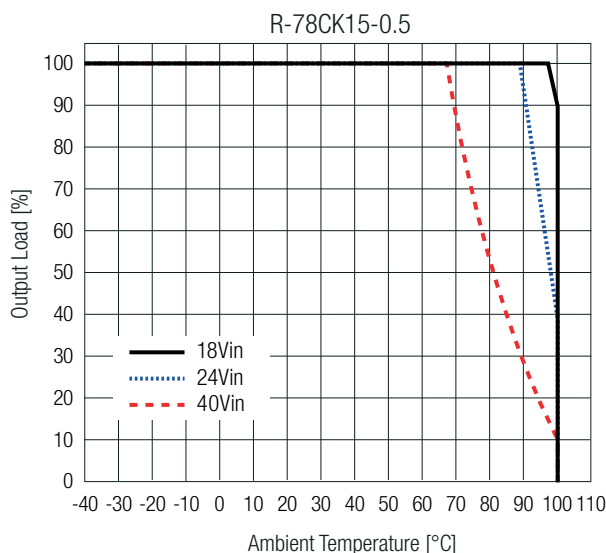
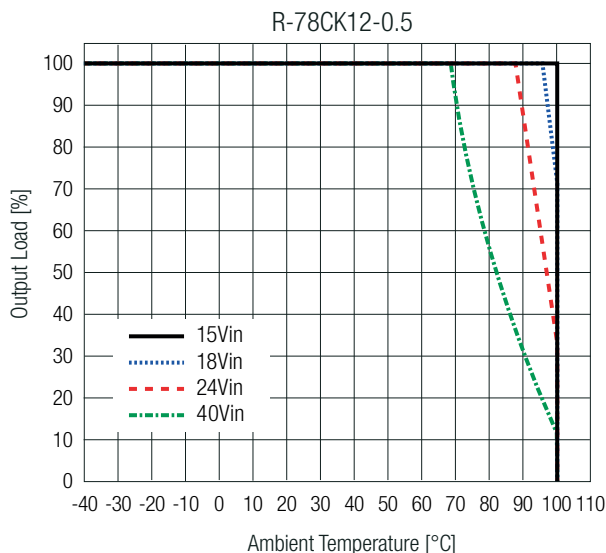
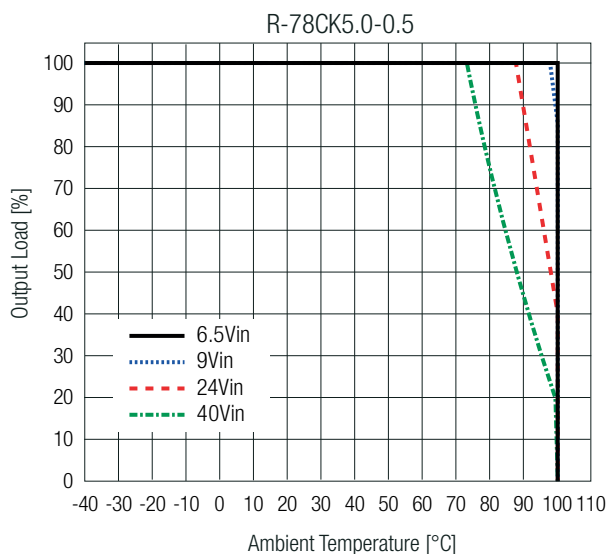
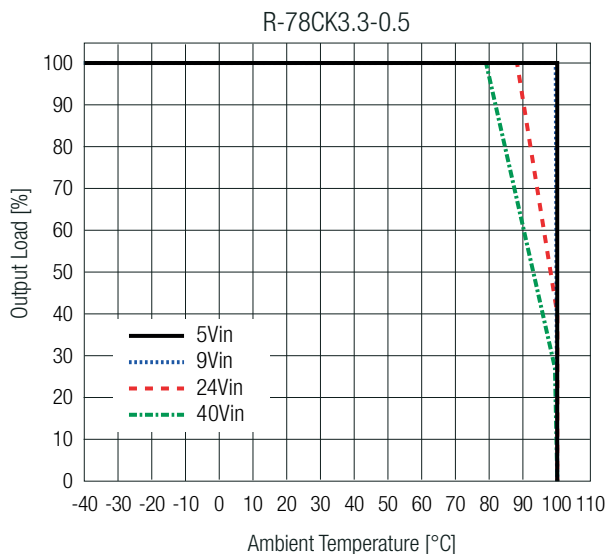

SAFETY AND CERTIFICATIONS

Certificate Type (Safety)	Report Number	Standard
Audio/Video, information and communication technology equipment - Part 1: Safety requirements (CB Scheme)	085-230092001-000	IEC62368-1:2018 3rd Edition
Audio/Video, information and communication technology equipment - Part 1: Safety requirements		EN IEC 62368-1:2020+A11:2020
RoHS2		RoHS 2011/65/EU + AM2015/863

SAFETY AND CERTIFICATIONS

EMC Compliance	Condition	Standard /Criterion
Electromagnetic compatibility of multimedia equipment - Emission requirements	with external filter refer to "EMC filtering"	EN55032, Class A and B

EMC filtering suggestion according to EN55032

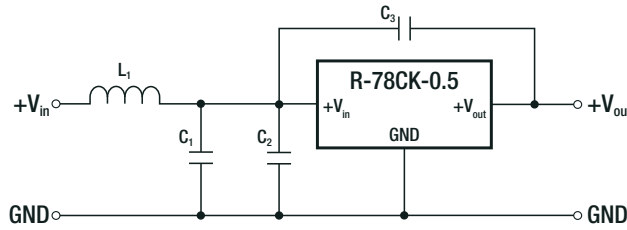

Component List Class A

MODEL	L1	C1	C2	C3
R-78CK3.3-0.5	RLS-126	10µF	N/A	1nF
R-78CK5.0-0.5				
R-78CK12-0.5				
R-78CK15-0.5				

Component List Class B

MODEL	L1	C1	C2	C3
R-78CK3.3-0.5	RLS-126	10µF	N/A	1nF
R-78CK5.0-0.5			1µF	

Note4: Filter suggestions are valid for indicated part numbers only. For other part numbers, please contact RECOM for advice.

DIMENSION & PHYSICAL CHARACTERISTICS

Parameter	Type	Value
Material	case	black plastic, (UL94 V-0)
	potting	PU, (UL94 V-0)
	PCB	FR4, (UL94 V-0)
Dimension (HxWxD)		11.5 x 7.55 x 10.2mm 0.45 x 0.30 x 0.40 inch
Weight		1.7g typ. 0.037 lbs

Dimension Drawing (mm)

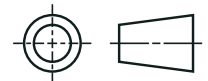
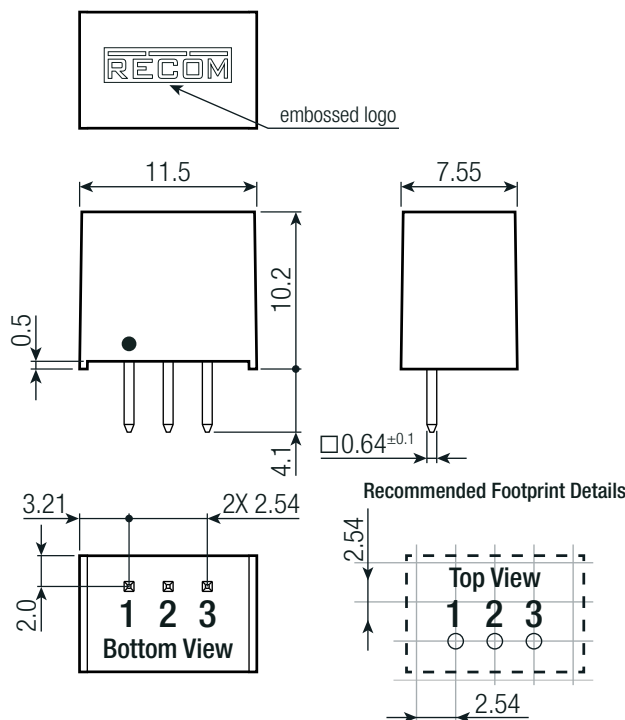

Pinning Information

Pin #	Function
1	+V _{IN}
2	GND
3	+V _{OUT}

Recommended Footprint Details

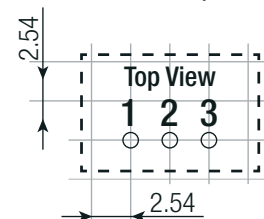

Tolerances:
x.x= ±0.5mm
x.xx= ±0.25mm

SELECTION GUIDE (NEGATIVE LOGIC)

Part Number	Input Voltage Range [VDC]	Output Voltage [VDC]	Output Current [mA]	Efficiency	
				@ min. Vin [%]	@ max. Vin [%]
R-78CK3.3-0.5	5 - 36.5	-3.3	-500	78	71
R-78CK5.0-0.5	6.5 - 35	-5.0	-500	82	77
R-78CK12-0.5	15 - 28	-12	-500	87	86
R-78CK15-0.5	18 - 25	-15	-500	87	86

Note5: When using the R-78CK as positive-to-negative converter, the input voltage range is limited

Positive to Negative Converter

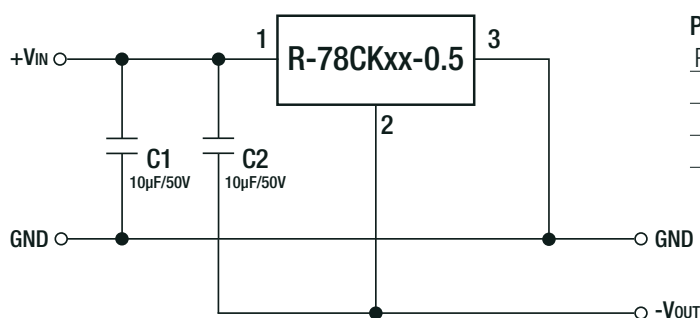

Pin Connections

Pin #	Negative	Positive
1	+Vin	+Vin
2	-Vout	GND
3	GND	+Vout

Dual Output (Two Converters) with Negative Output

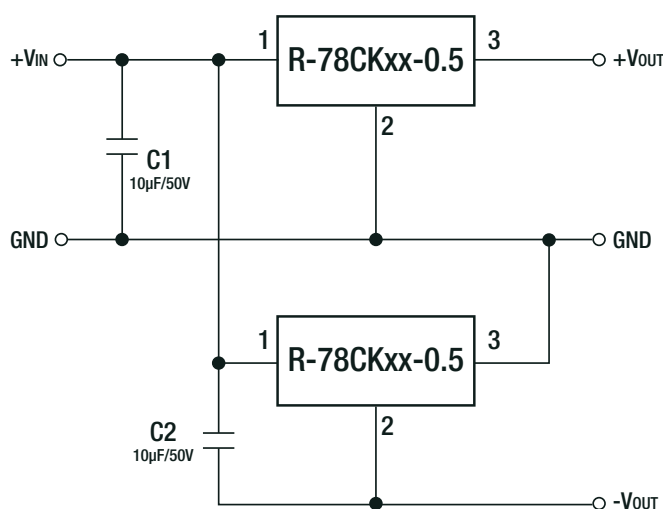

Note6: When connecting two R-78CK together to create a dual output, both connectors must be connected in parallel. Connecting them in series may lead to start-up issues with the second R-78CK.

BASIC CHARACTERISTICS (NEGATIVE LOGIC)

Efficiency vs. Load (negative)

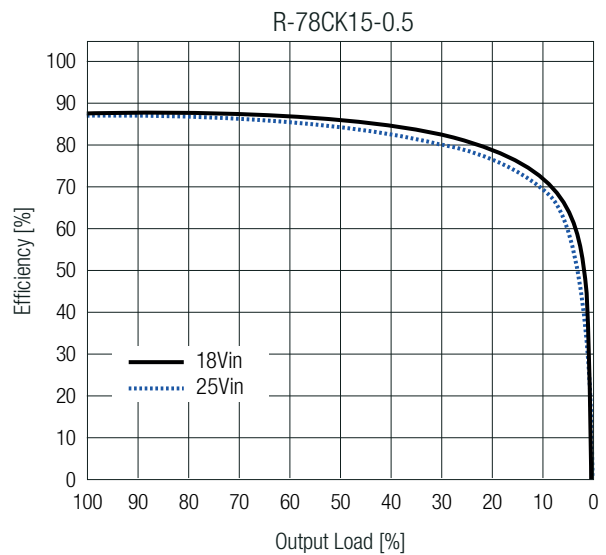
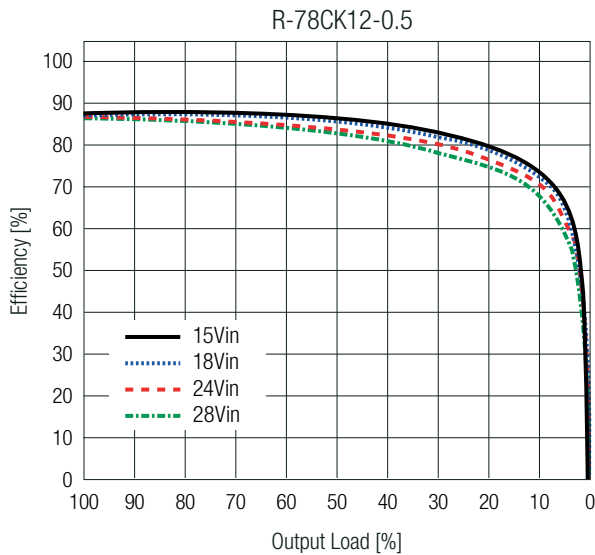
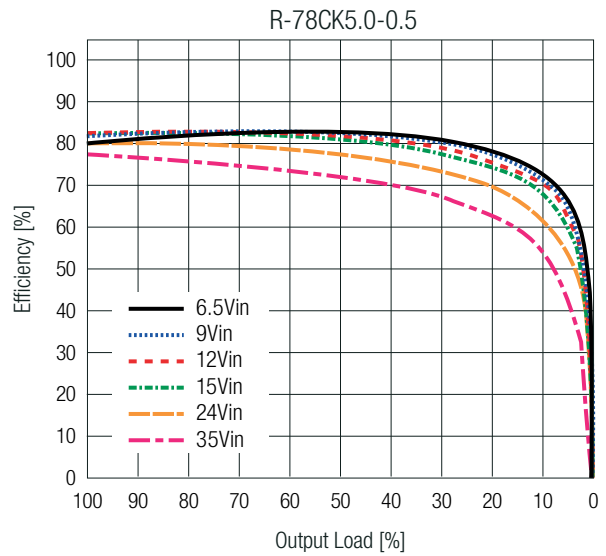
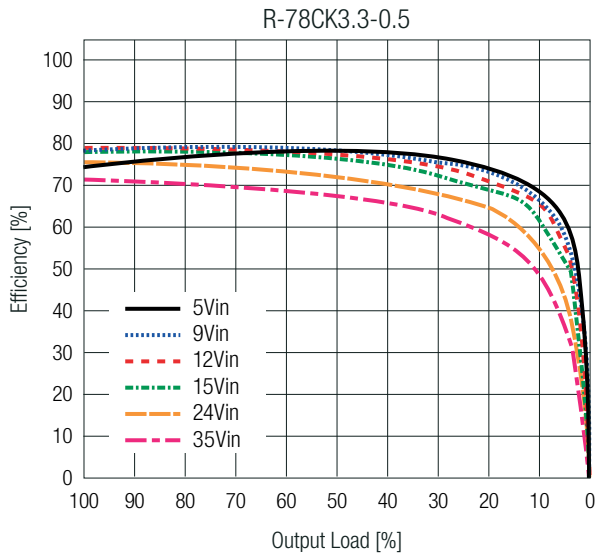

Derating Graph (negative)

(@ Chamber and natural convection 0.1m/s, over Vin)

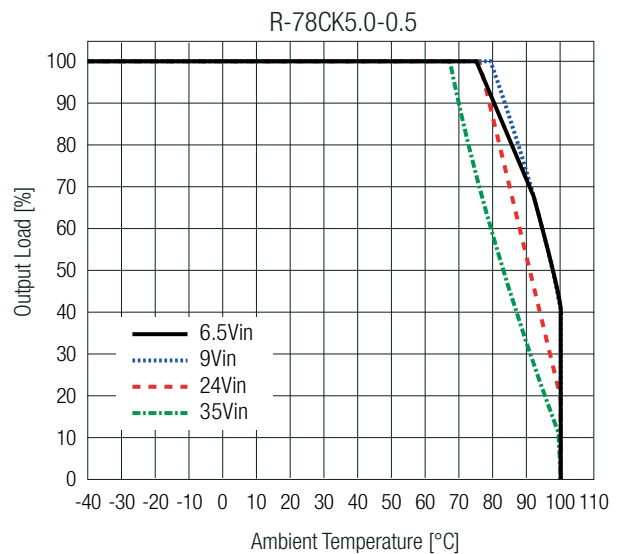
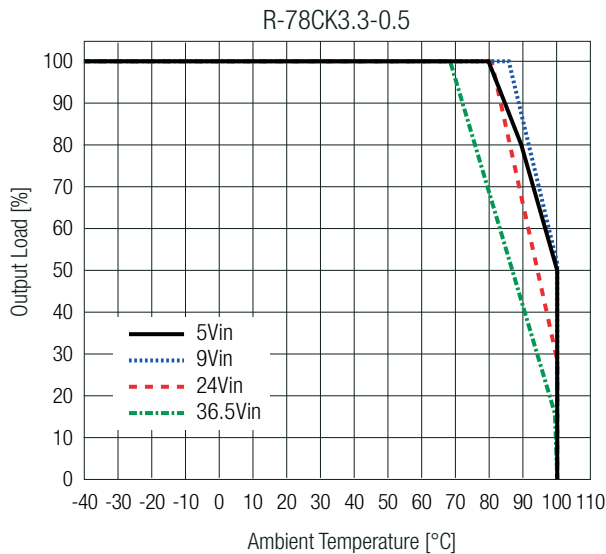

R-78CK-0.5 series

0.5Amp / SIP3 Single Output

BASIC CHARACTERISTICS (NEGATIVE LOGIC)

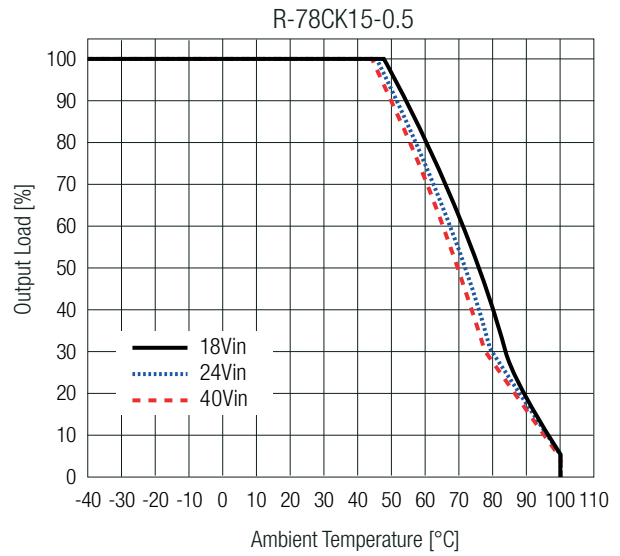
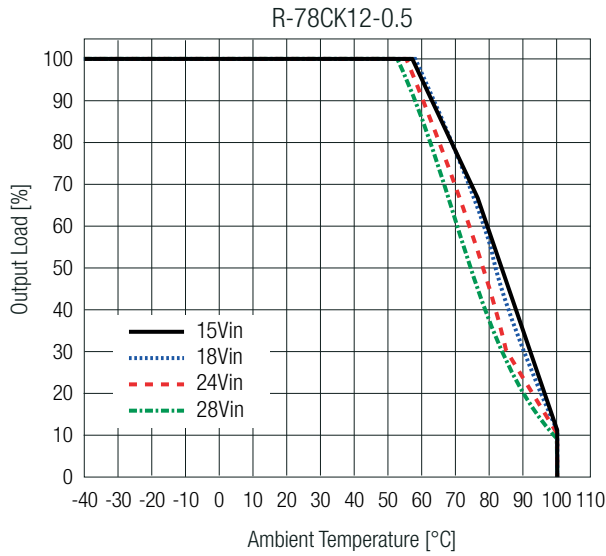

PACKAGING INFORMATION

Parameter	Type	Value
Packaging Dimension (LxWxH)	tube	520.0 x 9.2 x 19.0mm
Packaging Quantity		43pcs
Storage Temperature Range		-40°C to +125°C
Storage Humidity	non-condensing	95% RH max.

The product information and specifications may be subject to changes even without prior written notice. The product has been designed for various applications; its suitability lies in the responsibility of each customer. The products are not authorized for use in safety-critical applications without RECOM's explicit written consent. A safety-critical application is an application where a failure may reasonably be expected to endanger or cause loss of life, inflict bodily harm or damage property. The applicant shall indemnify and hold harmless RECOM, its affiliated companies and its representatives against any damage claims in connection with the unauthorized use of RECOM products in such safety-critical applications.