

Xtender, Unit combining inverter, battery charger and transfer system.

User manual

XTH 3000-12

XTH 5000-24

XTH 6000-48

XTH 8000-48

XTM 1500-12

XTM 2000-12

XTM 2400-24

XTM 3500-24

XTM 2600-48

XTM 4000-48

Temperature sensor
Command module

BTS-01
RCM-10



SUMMARY

1	INTRODUCTION	3
2	GENERAL INFORMATION	3
2.1	Operating instructions.....	3
2.2	Conventions	4
2.3	Quality and warranty	4
2.3.1	Exclusion of warranty.....	4
2.3.2	Exclusion of liability.....	5
2.4	Warnings and notes	5
2.4.1	General.....	5
2.4.2	Precautions for using the batteries.....	6
3	ASSEMBLY AND INSTALLATION	6
3.1	Handling and moving	6
3.2	Storage.....	6
3.3	Unpacking	6
3.4	Installation site	6
3.5	Fastening.....	7
3.5.1	Fastening XTH model	7
3.5.2	Fastening XTM model	7
3.6	Connections.....	7
3.6.1	General recommendations	7
3.6.2	Device connection compartment.....	9
4	CABLING	10
4.1	Choice of system	11
4.1.1	Hybrid type stand-alone systems.....	11
4.1.2	Grid-connected emergency systems.....	11
4.1.3	Integrated mobile systems	11
4.1.4	Multi-unit systems.....	11
4.2	Earthing system	11
4.2.1	Mobile installation or installation connected to the grid via plug connector	12
4.2.2	Stationary installation	12
4.2.3	Installation with automatic PE-neutral switching	12
4.3	Recommendations for dimensioning the system	13
4.3.1	Dimensioning the battery	13
4.3.2	Dimensioning the inverter	13
4.3.3	Dimensioning the generator	13
4.3.4	Dimensioning the renewable energy sources.....	13
4.4	Wiring diagrams	14
4.5	Connecting the battery	14
4.5.1	Battery cable cross-section and DC protective devices	14
4.5.2	Connecting the battery (Xtender side).....	15
4.5.3	Fuse mounting on battery positive pole (XTM only)	15
4.5.4	Battery-side connection	15
4.5.5	Earthing the battery.....	16
4.5.6	Connecting the consumers at the 230 V AC output	16
4.5.7	Connecting the AC supply sources.....	17
4.5.8	Wiring auxiliary contacts.....	17
4.5.9	Connecting the communications cables.....	17
4.5.10	Connecting the temperature sensor (BTS-01).....	17
4.5.11	Connecting the remote command module RCM10 (XTM only)	18
5	POWERING UP THE INSTALLATION	18
6	DESCRIPTION AND FUNCTIONING	19
6.1	Circuit diagram.....	19
6.2	Description of the main functions.....	20
6.2.1	Inverter	20
6.2.2	Automatic load detection	20
6.2.3	Transfer relay	20

6.2.4	Battery charger	21
6.2.5	Limiting the input current by limiting the charger current	22
6.2.6	The inverter as source backup ("Smart Boost" function)	23
6.2.7	Input current controlled by input voltage.....	24
6.2.8	Battery protection.....	24
6.2.9	Xtender protection	24
6.2.10	Auxiliary contacts	24
6.2.11	The real time clock.....	25
6.2.12	Entry command (Remote control on/off)	25
6.3	Multi-unit configurations.....	25
6.3.1	Three-phase system	26
6.3.2	Increasing the power by paralleling units.....	26
6.3.3	Combined system.....	27
6.4	Accessories.....	27
6.4.1	Control centre and display RCC-02/03 (remote control)	27
6.4.2	BTS-01 temperature sensor.....	28
6.4.3	Remote control Module RCM-10.....	29
7	CONTROL	29
7.1	Main on/off control	29
7.2	Display and control panel.....	30
8	MAINTENANCE OF THE INSTALLATION	32
9	PRODUCT RECYCLING	32
10	EC DECLARATION OF CONFORMITY.....	33
11	COMMENTS OF APPENDIX DRAWINGS.....	34
12	DRAWING'S ELEMENTS (DC PART).....	36
13	FIGURE ELEMENT'S (AC PART).....	37
14	ELEMENTS OF CONNECT CABINET (FIG 4A).....	38
15	CONTROL AND DISPLAY PARTS FOR THE XTENDER (FIG. 4B)	39
16	MODEL IDENTIFICATION (FIG. 1B).....	40
17	TABLE OF STANDARD CONFIGURATIONS.....	41
18	TECHNICAL DATA – XTH.....	43
19	TECHNICAL DATA – XTM.....	45
20	NOTES	47

1 INTRODUCTION

Congratulations! You are about to install and use a device from the Xtender range. You have chosen a high-tech device that will play a central role in energy saving for your electrical installation. The Xtender has been designed to work as an inverter / charger with advanced functions, which can be used in a completely modular way and guarantee the faultless functioning of your energy system.

When the Xtender is connected to a generator or network, the latter directly supplies the consumers, and the Xtender works like a battery charger and backup device if necessary. The powerful battery charger has an exceptional high efficiency and power factor correction (PFC) close to 1. It guarantees excellent battery charging in all situations. The charge profile is freely configurable according to the type of battery used or the method of usage. The charge voltage is corrected depending on the temperature, thanks to the optional external sensor. The power of the charger is modulated in real time dependent according to the demand of the equipment connected at the Xtender output and the power of the energy source (network or generator). It can even temporarily backup the source if the consumer demand exceeds the source capacity.

The Xtender continuously monitors the source to which it is connected (network or generator) and disconnects itself immediately if the source is missing, disturbed or does not correspond to the quality criteria (voltage, frequency, etc.). It will then function in independent mode, thanks to the integrated inverter. This inverter, which has an extremely robust design, benefits from STUDER Innotec's many years of experience and expertise in this area. It could supply any type of load without faults, enjoying reserves of additional power that is unmatched on the market. All your equipment will be perfectly provided with energy and protected from power outages in systems where energy supply is unpredictable (unreliable network) or voluntarily limited or interrupted, such as hybrid installations on remote sites or mobile installations.

The parallel and/or three-phase network operation of the Xtender offers modularity and flexibility and enables optimum adaptation of your system to your energy requirements.

The RCC-02/03 control, display and programming centre (optional) enables optimum configuration of the system and guarantees the operator continuous control for all important configurations in the installation.

In order to guarantee perfect commissioning and functioning of your installation, please read this manual carefully. It contains all the necessary information relating to the functioning of the inverters / chargers in the Xtender series. The setting up of such a system requires special expertise and may only be carried out by qualified personnel familiar with the applicable local regulations.

2 GENERAL INFORMATION

2.1 OPERATING INSTRUCTIONS

This manual is an integral part of each inverter/charger from the Xtender series.

It covers the following models and accessories¹:

Inverter/charger: XTH 3000-12 – XTH 5000-24 – XTH 6000-48 – XTH 8000-48

Inverter/charger: XTM 1500-12, XTM 2000-12, XTM 2400-24,

XTM 3500-24, XTM 2600-48, XTM 4000-48

Temperature sensor: BTS-01

Remote command module: RCM-10



For greater clarity, the device is referred to in this manual as Xtender, unit or device, when the description of its functioning applies indiscriminately to different Xtender models.

These operating instructions serve as a guideline for the safe and efficient usage of the Xtender. Anyone who installs or uses an Xtender can rely completely on these operating instructions, and is bound to observe all the safety instructions and indications contained. The installation and commissioning of the Xtender must be entrusted to a qualified professional. The installation and

¹ Also for 120Vac model (-01)

usage must conform to the local safety instructions and applicable standards in the country concerned.

2.2 CONVENTIONS

	This symbol is used to indicate the presence of a dangerous voltage that is sufficient to constitute a risk of electric shock.
	This symbol is used to indicate a risk of material damage.
	This symbol is used to indicate information that is important or which serves to optimise your system.

All values mentioned hereafter, followed by a configuration no. indicate that this value may be modified with the help of the RCC-02/03 remote control.

In general, the default values are not mentioned and are replaced by a configuration no. in the following format: {xxxx}. The default values for this configuration are specified in the configuration table, p. 41.

	All configuration values modified by the operator or installer must be transferred into the same table. If a parameter not appearing in the list (advanced configurations) has been modified by an authorised person with technical knowledge, they will indicate the number of the modified parameter(s), the specifications of the configuration(s) and the new value set, at the end of the same table.
--	--

All figures and letters indicated in brackets refer to items of figures in the separate manual "Appendix to the installation and operating instructions" supplied with the device.

The **figures in brackets** refer to elements belonging to the Xtender.

The **uppercase letters** in brackets refer to **AC** cabling elements.

The **lowercase letters** in brackets refer to **battery** cabling elements.

2.3 QUALITY AND WARRANTY

During the production and assembly of the Xtender, each unit undergoes several checks and tests. These are carried out with strict adherence to the established procedures. Each Xtender has a serial number allowing complete follow-up on the checks, according to the particular data for each device. For this reason it is very important never to remove the type plate (appendix I – fig. 3b) which shows the serial number. The manufacture, assembly and tests for each Xtender are carried out in their entirety by our factory in Sion (CH). The warranty for this equipment depends upon the strict application of the instructions appearing in this manual.

The warranty period for the Xtender is 2 years.

2.3.1 Exclusion of warranty

No warranty claims will be accepted for damage resulting from handling, usage or processing that does not explicitly appear in this manual. Cases of damage arising from the following causes are notably excluded from the warranty:

Surge voltage on the battery input (for example, 48 V on the battery input of an XTH 3000-12)

Incorrect polarity of the battery

The accidental ingress of liquids into the device or oxidation resulting from condensation

Damage resulting from falls or mechanical shocks

Modifications carried out without the explicit authorisation of Studer Innotec

Nuts or screws that have not been tightened sufficiently during the installation or maintenance

Damage due to atmospheric surge voltage (lightning)

Damage due to inappropriate transportation or packaging
Disappearance of original marking elements

2.3.2 Exclusion of liability

The placement, commissioning, use, maintenance and servicing of the Xtender cannot be the subject of monitoring by Studer Innotec. For this reasons we assume no responsibility and liability for damage, costs or losses resulting from an installation that does not conform to the instructions, defective functioning or deficient maintenance. The use of a Studer Innotec inverter is the responsibility of the customer in all cases.

This equipment is neither designed nor guaranteed to supply installations used for vital medical care nor any other critical installation carrying significant potential damage risks to people or the environment.

We assume no responsibility for the infringement of patent rights or other rights of third parties that result from using the inverter.

Studer Innotec reserves the right to make any modifications to the product without prior notification.

2.4 WARNINGS AND NOTES

2.4.1 General

	This manual is an integral part of the device and must be kept available for the operator and installer. It must remain close to the installation so that it may be consulted at any time.
--	--

The configuration table available at the end of the manual (p. 41) must be kept up to date in the event of modification of the configurations by the operator or installer. The person in charge of installation and commissioning must be wholly familiar with the precautionary measures and the local applicable regulations.

	<p>When the Xtender is running, it generates voltage that can be potentially lethal. Work on or close to the installation must only be carried out by thoroughly trained and qualified personnel. Do not attempt to carry out ongoing maintenance of this product yourself. The Xtender or the generator connected to it may start up automatically under certain predetermined conditions.</p> <p>When working on the electrical installation, it is important to be certain that the source of DC voltage coming from the battery as well as the source of AC voltage coming from a generator or network have been disconnected from the electrical installation.</p> <p>Even when the Xtender has been disconnected from the supply sources (AC and DC), a dangerous voltage may remain at the outputs. To eliminate this risk you must switch the Xtender OFF using the ON/OFF button (1). After 10 seconds the electronics is discharged and intervention may take place without any danger.</p>
---	---

All elements connected to the Xtender must comply with the applicable laws and regulations. Persons not holding written authorisation from Studer Innotec are not permitted to proceed with any change, modification or repairs that may be required. Only original parts may be used for authorised modifications or replacements.

This manual contains important safety information. Read the safety and working instructions carefully before using the Xtender. Adhere to all the warnings given on the device as well as in the manual, by following all the instructions with regard to operation and use.

The Xtender is only designed for indoor use and must under no circumstances be subjected to rain, snow or other humid or dusty conditions.

The maximum specifications of the device shown on the type plate, as at fig. 1b, must be adhered to.

In the event of use in motorised vehicles, the Xtender must be protected from dust, splash water and any other humid condition. It must also be protected from vibration by installing absorbent parts.

2.4.2 Precautions for using the batteries

Lead-acid or gel batteries produce a highly explosive gas with normal use. No source of sparks or fire should be present in the immediate vicinity of the batteries. The batteries must be kept in a well-ventilated place and be installed in such a way as to avoid accidental short-circuits when connecting.

Never try to charge frozen batteries.

When working with the batteries, a second person must be present in order to lend assistance in the event of problems.

Sufficient fresh water and soap must be kept to hand to allow adequate and immediate washing of the skin or eyes affected by accidental contact with the acid.

In the event of accidental contact of the eyes with acid, they must be washed carefully with cold water for 15 minutes. Then immediately consult a doctor.

Battery acid can be neutralised with baking soda. A sufficient quantity of baking soda must be available for this purpose.

Particular care is required when working close to the batteries with metal tools. Tools such as screwdrivers, open-ended spanners, etc. may cause short-circuits. Consequently occurring sparks may cause the battery to explode.

When working with the batteries, all metal jewellery such as rings, bracelet watches, earrings, etc., must be taken off. The current output by the batteries during a short-circuit is sufficiently powerful to melt the metal and cause severe burns.

In all cases, the instructions of the battery manufacturer must be followed carefully.

3 ASSEMBLY AND INSTALLATION

3.1 HANDLING AND MOVING

The weight of the Xtender is between 35 and 50kg depending upon the model. Use an appropriate lifting method as well as help from a third party when installing the equipment.

3.2 STORAGE

The equipment must be stored in a dry environment at an ambient temperature of between -20°C and 60°C. It stays in the location where it is to be used a minimum of 24 hours before being set up.

3.3 UNPACKING

When unpacking, check that the equipment has not been damaged during transportation and that all accessories listed below are present. Any fault must be indicated immediately to the product distributor or the contact given at the back of this manual.

Check the packaging and the Xtender carefully.

Standard accessories:

Installation and operating instructions, c.f. Appendix 1

Mounting plate – fig. 2a (18)

2 conduit glands for the battery cable

3.4 INSTALLATION SITE

The installation site for the Xtender is of particular importance and must satisfy the following criteria:

Protected from any unauthorised person.

Protected from water and dust and in a place with no condensation.

It must not be situated directly above the battery or in a cabinet with it.

No easily inflammable material should be placed directly underneath or close to the Xtender.

Ventilation apertures must always remain clear and be at least 15cm from any obstacle that may affect the ventilation of the equipment according to fig. 2b.

In mobile applications it is important to select an installation site that ensures as low a vibration level as possible.

3.5 FASTENING



The Xtender is a heavy unit and must be mounted to a wall designed to bear such a load. A simple wooden panel is insufficient.

The Xtender must be installed vertically with sufficient space around it to guarantee adequate ventilation of the device (see figs. 2a and 2b).

3.5.1 Fastening XTH model

Firstly fix the mounting bracket (18) supplied with the device using 2 Ø < 6-8 mm > screws**.

Then hang the Xtender on the bracket. Fasten the unit permanently using 2 Ø < 6-8 mm > screws** on to the two notches located at the underside of the case.

3.5.2 Fastening XTM model

Screw on a solid wall (concrete or metallic wall) an M8 screw without washer up to a distance of 1.6 mm of the wall.

Hang the apparatus by having care to release beforehand the trap door of access (17) by inserting it inside the apparatus using a screwdriver, if you estimate that a complete tightening of this point of fixing is necessary. In theory complete tightening is necessary only in the mobile installations.

Dismount the lower plastic cap of the apparatus giving access to the compartment of wiring. Carefully fix the apparatus with two screws (Ø 6-8 mm) in the two clamp holes (16) inside the compartment of wiring.

If the Xtender is installed in a closed cabinet this must have sufficient ventilation to guarantee an ambient temperature that conforms to the operation of the Xtender.

*** : These items are not delivered with the device.*



It is imperative to ensure complete and safe fastening of the device. A device that is simply hung may detach and cause severe damage.

In motor vehicles or when the support may be subject to strong vibrations, the Xtender must be mounted on anti-vibration supports.

3.6 CONNECTIONS

3.6.1 General recommendations

The Xtender falls within protection class I (has a PE connection terminal). It is vital that a protective earth is connected to the AC IN and/or AC OUT PE terminals. An additional protective earth is located between the two fastening screws at the bottom of the unit (fig. 2b-(17)).



In all cases, the PE conductor for the equipment must at least be connected to the PE for all equipment in protection class I upstream and downstream of the Xtender (equipotential bonding). It is mandatory that the legislation in force for the application concerned be adhered to.

Tighten of the input (13) and output (14) terminals by means of a no. 3 screwdriver and those for the "REMOTE ON/OFF" (7) and "AUX.CONTAC" (8) by means of a no. 1 screwdriver.

The cable sections of these terminals must conform to local regulations.

All connection cables as well as the battery cables must be mounted using cable restraints in order to avoid any traction on the connection.

Battery cables must also be as short as possible and the section must conform with the applicable regulations and standards. Sufficiently tighten the clamps on the "battery" inputs (fig. 4a (11) and (12)).

3.6.2 Device connection compartment



The unit's connection compartment must remain permanently closed when in operation. It is imperative to close the protection cap on the connection terminals after each intervention in the device. After opening, check that all sources of AC and DC voltage (batteries) have been disconnected or put out of service.

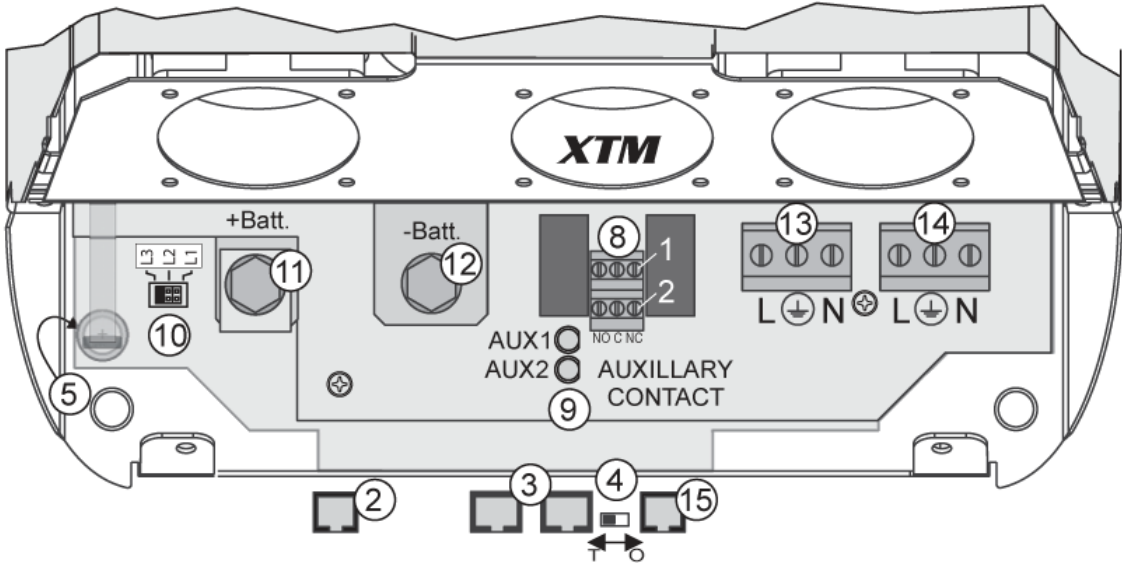
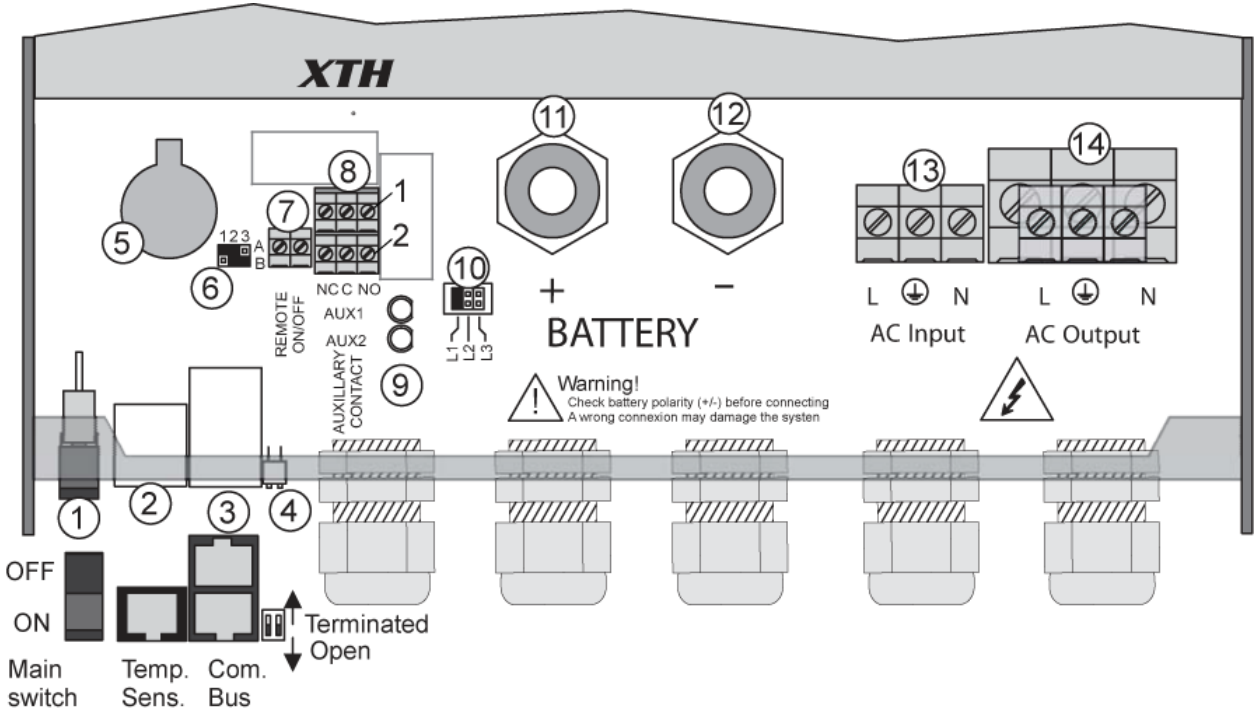

Pos.	Denomination	Description	Comment
1	ON/OFF Main switch	Main on/off switch	See chapter 7.1 - p 29. In XTM series, this function is deported on the remote command module RCM-10. See chap.6.4.3 – p.29
2	Temp. Sens	Connector for the battery temperature sensor	See chapter 6.4.2 – p. 28. Only connect the original Studer BTS-01 sensor
3	Com. Bus	Double connector for connecting peripherals such as the RCC002/03 or other Xtender units	See chapter 4.5.9 – p. 17. The two termination switches (4) for the communication bus both remain in position T (terminated) except when both connectors are in use.
4	O / T (Open / Terminated)	Switch for terminating the communication bus.	
5	--	3.3 V (CR-2032) lithium ion type battery socket	Used as a permanent supply for the internal clock. See chapter The real time clock 6.2.11 - p 25.
6	--	Jumper for programming the off/on switch by dry contact	See chapter 6.2.12 – p. 24 and fig. 8b point (6) and (7). They are positioned at A-1/2 and B-2/3 by default
7	REMOTE ON/OFF	Entry command terminals.. In XTM series, this entry is deported on the remote command module RCM-10. See chap. 6.4.3 – p. 29	Allow to give a function – to be defined by programming – by the closing of a dry contact or by the presence of a voltage across these terminals. See chapter 6.2.12– p. 24).
8	AUXILLARY CONTACT	Auxiliary contact	(See chapter 6.2.10– p. 24) Take care not to exceed the admissible loads
9	--	Activation indicators for auxiliary contacts 1 and 2	See chapter 6.2.10– p. 24
10	L1/L2/L3	Phase selection jumpers.	See chapter 6.3.1. – p.26. Jumper default at position L1
11	+BAT	Positive pole battery connection terminals	Carefully read chapter 4.5 – p.14 Take care with the polarity of the battery and when tightening the clamp.
12	-BAT	Negative pole battery connection terminals	
13	AC Input	Connection terminals for the alternative power supply (generator or public network)	See chapter 4.5.7 - p. 17. Note: It is imperative that the PE terminal be connected.
14	AC Output	Connection terminals for the device output.	See chapter 4.5.6 - p. 17. Note: Increased voltages may appear on the terminals, even in the absence of voltage at the input of the inverter.
15	RCM-10	Connector for RCM-10 module	Only on XTM. See chap. 6.4.3 – p.29

4 CABLING

The connection of the Xtender inverter / charger is an important installation step.

It may only be carried out by qualified personnel and in accordance with the applicable local regulations and standards. The installation must always comply with these standards.

Pay attention that connections are completely tightened and that each wire is connected at the right place.

4.1 CHOICE OF SYSTEM

The Xtender may be used in different system types, each of which must meet the standards and particular requirements associated with the application or site of installation. Only an appropriately qualified installer can advise you effectively on the applicable standards with regard to the various systems and the country concerned.

Examples of cabling are presented in appendix I of this manual, fig. 5 and following. Please carefully read the notes associated with these examples in the tables on p. 33 and following.

4.1.1 Hybrid type stand-alone systems

The Xtender can be used as a primary supply system for grid-remote sites where a renewable energy source (solar or hydraulic) is generally available and a generator is used as backup. In this case, batteries are generally recharged by a supply source such as solar modules, wind power or small hydropower systems. These supply sources must have their own voltage and/or current regulation system and are connected directly to the battery. (Example, fig. 11)

When the energy supply is insufficient, a generator is used as a back-up energy source. This allows the batteries to be recharged and direct supply to consumers via the Xtender transfer relay.

4.1.2 Grid-connected emergency systems

The Xtender can be used as an emergency system, also known as an uninterruptible power supply (UPS) – enabling a reliable supply to a site connected to an unreliable network. In the event of an interruption to the energy supply from the public network, the Xtender, connected to a battery, substitutes the faulty source and enables a support supply to the users connected downstream. These will be supplied as long as the energy stored in the battery allows. The battery will quickly be recharged at the next reconnection to the public grid.

Various application examples are described in figs. 8a – 8c in appendix I.



The use of the Xtender as a UPS must be carried out by qualified personnel who have been checked by the responsible local authorities. The diagrams in the appendix are given for information and as a supplement. The applicable local standards and regulations must be adhered to.

4.1.3 Integrated mobile systems

These systems are meant to be temporarily connected to the grid and ensure the supply of the mobile system when this is disconnected from the grid. The main applications are for boats, service vehicles and leisure vehicles. In these cases, two separate AC inputs are often required, one connected to the grid and the other connected to an on-board generator. Switching between two sources must be carried out using an automatic or manual reversing switch, conforming to the applicable local regulations. The Xtender has a single AC input.

Various application examples are described in figs. 10a – 10b – 10c).

4.1.4 Multi-unit systems

Whatever system is selected, it is possible to realise systems composed of several units of the same type and the same power output. Up to three Xtenders in parallel or three extenders forming a three-phase grid or three times two or three Xtenders in parallel forming a three-phase / parallel grid, may be thus combined.

4.2 EARTHING SYSTEM

The Xtender is a protection class I unit, which is intended for cabling in a grid type TT, TN-S or TNC-S. The earthing of the neutral conductor (E) is carried out at a sole installation point, upstream of the RCD circuit breaker (D).

The Xtender can be operated with any earthing system. In all cases it is imperative that the protective earth be connected in compliance with the applicable standards and regulations. The information, notes, recommendations and diagram mentioned in this manual are subject to local installation regulations in every case. The installer is responsible for the conformity of the installation with the applicable local standards.

4.2.1 Mobile installation or installation connected to the grid via plug connector

When the input of the device is connected directly to the grid via a plug, the length of the cable must not exceed 2 m and the plug must remain accessible.

In the absence of voltage at the input, the neutral and live are interrupted, thereby guaranteeing complete isolation and protection of the cabling upstream of the Xtender.

The earthing system downstream of the Xtender is determined by the upstream earthing system when the grid is present. In the absence of the grid, the earthing system downstream of the inverter is in isolated mode. The safety of the installation is guaranteed by the equipotential bonding.



The connection (link) between the neutrals (C) upstream and downstream of the Xtender is not permitted in this configuration.

This connection type guarantees the optimal continuity for supplying the Xtender loads. The first isolation fault will not lead to an interruption in the supply.

If the installation requires the use of a permanent isolation controller this would have to be deactivated when the TT network is present at the Xtender input.



All sockets and protection class I devices connected downstream of the Xtender must be properly connected to the earth (earthed socket). The cabling rules above remain valid, including in installations, in all cases where the Xtender input is connected to the grid via a plug connector.

4.2.2 Stationary installation

The installation may be equivalent to a mobile installation (with interrupted neutral).

In a fixed installation where the neutral is connected to the earth at a single installation point upstream of the Xtender, it is permissible to carry out a connection of the neutrals in order to preserve an unchanged earthing system downstream, independent of the operating mode of the Xtender. This choice has the advantage of keeping the protection devices downstream of the Xtender. This connection can be executed according to the examples in appendix 1, or carried out by modifying the configuration {1486}

In this case the appearance of the first fault will lead to the installation stopping or the disconnection of the protection devices upstream and/or downstream of the Xtender.

Safety is guaranteed by the equipotential bonding and by any RCD circuit-breakers placed downstream.

This connection (C) is not permitted if a socket is installed upstream of the Xtender.

4.2.3 Installation with automatic PE-neutral switching

In certain applications, it is desirable to keep the neutral upstream and downstream of the Xtender separated (C) while re-establishing the earthing system (TN-S, TT or TNC-S) in the absence of voltage at the input. This can be programmed by the configuration {1485} via the RCC-02/03 remote control. This modification must be carried out possessing technical knowledge, at the responsibility of the installer and in conformity with the applicable regulations and standards.

This allows adherence to the requirements for an earth-neutral connection at the source.

4.3 RECOMMENDATIONS FOR DIMENSIONING THE SYSTEM

4.3.1 Dimensioning the battery

The battery capacity is dimensioned according to the requirements of the user – that is 5 to 10 times its average daily consumption. The discharge depth of the battery will therefore be limited and the service life of the battery will be extended.

On the other hand, the Xtender must have a battery capacity that is large enough to be able to take full advantage of the performance of the equipment. The minimum capacity of the batteries (expressed in Ah) is generally dimensioned in the following way: five times the rated power output of the Xtender / the battery voltage. For example, the model XTH 8048 must have a battery of a minimum capacity of $7000 \times 5 / 48 = 730$ Ah (C 10). Because of the inverter's extreme overload capacity, it is often recommended that this value be rounded up. An under-dimensioned battery may lead to an accidental and undesired stopping of the Xtender in the event of high instances of use. This stoppage will be due to a voltage that is insufficient on the battery, subject to a strong discharge current.

The battery will be selected with regard to the greatest value resulting from the calculations set out above.

The battery capacity determines the adjustment of the configuration {1137} "battery charge current". A value between 0.1 and 0.2 x C batt. [Ah] (C10) enables an optimum charge to be guaranteed.

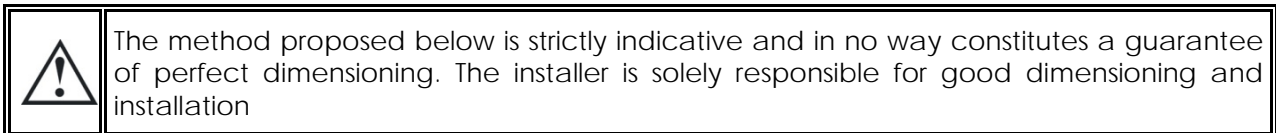

4.3.2 Dimensioning the inverter

The inverter is dimensioned in such a way that the rated power output covers the power of all the consumers which will be used at the same time. A dimensioning margin of 20 to 30% is recommended to guarantee that the Xtender will work well in an ambient temperature of more than 25 °C.

4.3.3 Dimensioning the generator

The power output of the generator must be the same or more than the average daily power. Optimally, it should be two or three times this power. Thanks to the Smart Boost function (see chap.6.2.6 p.23) it is not necessary to over-dimension the generator. Indeed, the loads those are temporarily higher than the power of the generator will be supplied by the inverter. Ideally it should not have a power output by phase that is less than half of the power of the Xtender(s) present at this phase.

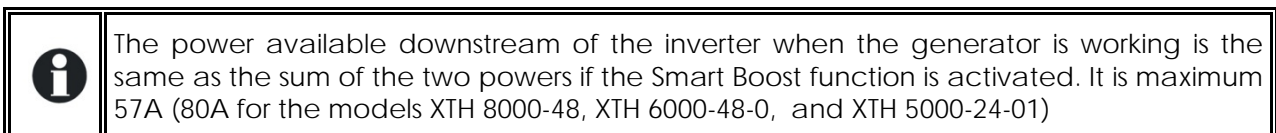

4.3.4 Dimensioning the renewable energy sources

In a hybrid system, the alternative energy sources such as the solar generator, wind power and small hydropower should, in principle, be dimensioned in such a way as to be able to cover the average daily consumption.

4.4 WIRING DIAGRAMS



The diagrams shown in the appendix of this document are subsidiary. The applicable local installation regulations and standards must be adhered to.
 The elements referred to with an uppercase letter denote the alternate current (AC) part.
 The elements referred to with a lowercase letter denote the direct current (DC) part.

4.5 CONNECTING THE BATTERY

Lead batteries are usually available in 2 V, 6 V or 12 V block types. In the majority of cases, in order to obtain an operating voltage that is correct for Xtender usage, several batteries must be connected in series or in parallel depending on the circumstances.



In multi-unit systems, all Xtenders from the same system must be connected according to the same battery bank.

The various cabling options are presented in figures 5a-5b (12 V), 5c-5e (24 V) and 6a to 6d (48 V) in appendix I of this manual.

4.5.1 Battery cable cross-section and DC protective devices



The battery cables must be protected by one of the following measures in all cases:

- protection device (fuse) at each pole
- protection device (fuse) on the pole not connected to the earth

The battery cables must also be as short as possible.

It is always preferable to keep the cable at the negative pole of the battery as short as possible.

In order to avoid any further loss and protection redundancy, the XTH does not have an internal fuse.

A protective device (f) must be installed as close as possible to the battery and sized according to the below table.

Range	Battery side fuse	Section of cable (<3m)
XTM-4000-48	200A	50mm ²
XTM-2600-48	100A	25mm ²
XTM-3500-24	300A	70mm ²
XTM-2400-24	200A	50mm ²
XTM-2000-12	300A	70mm ²
XTM-1500-12	250A	70mm ²
XTH-8000-48	300A	95mm ²
XTH-6000-48	300A	70mm ²
XTH-5000-24	300A	95mm ²
XTH-3000-12	350A	95mm ²

The recommended cable cross-sections are valid for lengths less than 3 m. beyond this length it is strongly recommended to oversize the battery cables.

	<p>The clamps must be carefully fixed and tightened sufficiently to guarantee minimum loss. Insufficient tightening may cause dangerous heating at the connection point.</p>
---	--

For safety reasons, we recommend an annual check on the tightness of all connections. For mobile installation the connections should be checked more frequently for tightness.

4.5.2 Connecting the battery (Xtender side)

Insert the conduit glands supplied on the battery cable before tightening the cable clamp. Crimp the cable clamps and fasten the conduit gland on the device. Repeat this for the second battery cable. Fix the battery cables to the appropriate connections „+ Battery “and „- Battery “. The M8 screws must be very well tightened.

On XTM range, you can insert , if required, a fuse directly on the positive connection to the battery following the below procedure.

4.5.3 Fuse mounting on battery positive pole (XTM only)

A fuse delivered with the unit (XTM) can be mounted directly on the positive connecting pole to the battery respecting the below stacking order.

The presence of this fuse does not exempt an installation of a protective device (fuse or circuit breaker) as close as possible of the battery.

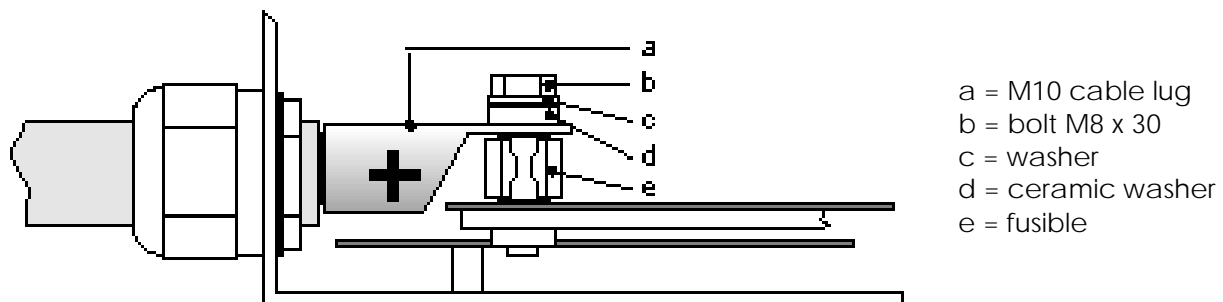

	<p>Be careful with the orientation of the ceramic washer. There is a small lip on one side which must fit into the cable lug's hole.</p>
---	--

4.5.4 Battery-side connection

	<p>Before connecting the battery, carefully check the voltage and polarity of the battery using a voltmeter. Incorrect polarity or surge voltage may seriously damage the device.</p>
---	---

Prepare the batteries for connection: appropriate battery clamps, protection device (f), cable in good conditions with correctly fitted clamps.

Fasten the negative cable on to the negative pole (-) of the battery and the positive cable on the open protection device (f).

	<p>When connecting the battery, a spark may occur when connecting the second pole. This spark is normal and due to the load of the internal filtering capacity of the Xtender even if the unit is halted by the main on off command (1).</p>
---	--



As of the connection of the battery, it is necessary to check that the configuration values of the Xtender are conform to the recommendations of the battery manufacturer. Non-conforming values may be dangerous and/or seriously damage the batteries.

The default values of the battery's charge threshold level are shown in fig. 3a and specified in the configuration table p.41. If they prove not to conform, it is necessary to modify them via the RCC 02/03 remote control before connecting the voltage sources on the AC input. Studer Innotec is not responsible for default values not corresponding with the recommendations of the manufacturer.

If the factory settings are modified, the new values must be entered on the configuration table on p. 41 of this manual. The default values proposed by Studer Innotec are the usual values for lead acid battery or gel batteries (VRLA or AGM).

The cabling and connection of the installation should only be carried out by an appropriately qualified professional. The installation material such as cables, connectors, distribution boxes, fuses, etc. must be adapted and must conform to the applicable laws and regulations the application under consideration.

4.5.5 Earthing the battery

One of the two battery conductors can be earthed. This may be either the positive or negative pole. In all cases the installation must conform to the local regulations and usage or specific standards associated with the application.

In case of earthing, the earthing conductor section must at least be equivalent to the section of the battery conductor. The earthing of the equipment must also adhere to these regulations. In this case the use of the additional earthing screw is recommended (fig. 2b (17)), which is located at the front of the device between the two lower fastening screws.

4.5.6 Connecting the consumers at the 230 V AC output



High voltages may be present on the connection terminals (13) and (14). Make sure that the inverter is deactivated and that there is no AC or DC voltage present on the AC IN terminals and battery terminals, before proceeding with the connection.

The 230 V consumers must be connected on the "AC OUT" (14) connection terminals with the wire section conforming to the standards with regard to the rated current at the Xtender output (see fig. 1a). Distribution must conform to the local standards and regulations, and generally, be realised via a distribution table.

The Xtender terminals are marked in the following way:

N = neutral, L = live

 = protective earth (connected to the enclosure of the device).



Due to the source assistance function (Smart Boost) the current at the output of the device may be higher than the rated current of the inverter. It is the sum of the current supplied by the additional source and the current supplied by the inverter. In this case, the dimensioning of the output cables will be carried out by adding the current indicated on the protection device (H) located on the upstream of the unit, to the nominal current of the inverter. (See fig. 1a and chap. 6.2.6 – p. 23)

If the assistance function at the source (Smart Boost) is not used, the size of the protection device for the output (F) will be established at a maximum value equal to the rated current of the inverter, or at the maximum value of the protection device at the input (H) if this exceeds the rated current of the inverter.



An additional earthing terminal (15) is present between the two fastening screws at the bottom of the unit. It can be used instead of a connection on the input terminals of the device, particularly when cable cross-sections used at the output do not allow the use of a three-wire cable (live, earth and neutral) through the conduit glands of the connection cables of the input and output (AC IN and AC OUT), or when the earthing of one of the poles of the battery. PE required using same or greater cross-sections than the battery cable.

4.5.7 Connecting the AC supply sources

The Xtender is intended to be supplied by alternative voltage sources such as the public grid or a generator. Check that the rated voltage of the source corresponds to the rated voltage (34) of the Xtender specified on the type plate (fig. 3b).

The source must be connected to the input terminals marked "AC INPUT" (13) with sufficient wire section, depending on the power output of the source, and protected by a protection device of the appropriate calibre. This will be at the maximum equal to the current I AC in max (35) specified on the type plate (fig. 3b). The terminals are marked in the following way:

N = neutral, L = live

= protective earth (connected to the enclosure of the device).

4.5.8 Wiring auxiliary contacts

These contacts are reversing contacts that are potential-free. The admissible currents and voltages for these contacts are 16 A: 250 VAC/24VDC or 3 A: 50 VDC max. The representation of the contact near the terminals corresponds to the status of the contact in idle mode (light indicator (5) off). The cabling of these auxiliary contracts depends solely on the application and cannot be described in this manual.

The factory-set functions for these 2 auxiliary contacts are covered in the chapter 6.2.10 – p.24.

4.5.9 Connecting the communications cables

The Xtender is equipped with a pair of RJ45/8 connectors that allow information transfer via a communication bus for different consumer types which have the proprietary protocol of Studer Innotec. In this network all parties in the network are connected in series (chain).

The length of the communication bus cable must not exceed 300 m.

In a system comprising a single Xtender, the connection of the RCC-02 or RCC-03 may be conducted without stopping the Xtender (hot plug).

The communication bus will be used to interconnect other Xtender inverters in the case of a multi-unit application or to connect other types of users who have the proprietary protocol of Studer Innotec. In these cases, the installation must be switched off using the main "ON/OFF" button (1) to connect the units via the communication bus.



The 2 switches for the communication bus termination, "Com. Bus" (4) both remain in position T (terminated) except when both connectors are in use. In this case, and only in this case, both must be placed in the O open position. If one of the two connectors is not in use, the two termination switches (14) will be in position T.

4.5.10 Connecting the temperature sensor (BTS-01)

The temperature sensor, BTS-01 is supplied with a 3 m cable fitted with RJ11/6-type plugs. It may be connected or disconnected at any time (including when the device is in use) using the corresponding socket (2) marked "Temp. Sens." on the Xtender. Plug the connectors into the socket (2) until they click in. The temperature sensor sleeve may simply be stuck onto the battery or directly next to it. The temperature sensor will be recognised automatically and the correction made immediately.

4.5.11 Connecting the remote command module RCM10 (XTM only)

The remote command module RCM10 can be “hot plugged” on connector “RCM-10” (15) without stopping the operation of the system. A contact free of potential (1) can be connected between terminals 1 and 2. When this contact and closed, the apparatus is stopped as described in Chap. 7.1 p. 30. Terminals 4 to 6 of module RCM-10 are used as command entry as described in the chap. 6.1.12 p.26. It can be controlled by a dry contact (7) between 5 and 6 with a bridge between 3 and 4, or by a voltage AC or DC. of max 60 V eff. across pin 4 and 5

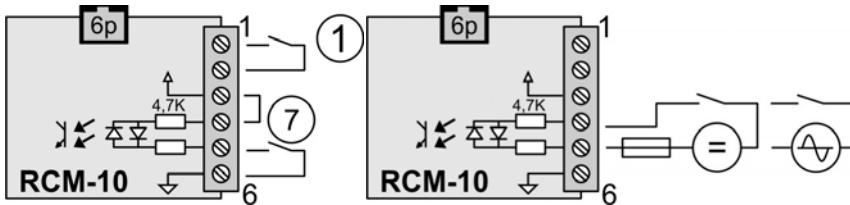

5 POWERING UP THE INSTALLATION

	<p>It is imperative that the closing cap for the connection compartment be installed and screwed tight before the installation is energised. There are dangerous voltages within the interior of the connection compartment.</p>
--	--

The Power up of the Xtender must be carried out in the order given below. Any Power off must be carried out in the reverse order.

- Connecting the battery

	<p>A too high or inappropriate battery voltage may seriously damage the Xtender. For example, installing a 24 V battery in the Xtender 3000-12.</p> <p>If the Xtender has been connected the wrong way around by accident (incorrect polarity of the battery) it is highly likely that the protection fuse on the battery cable may melt and will have to be replaced. If such is the case, it will be necessary to disconnect all the connections to the Xtender including the battery. If, after replacing the fuse, the Xtender proves not to work correctly after reconnecting the battery with the correct polarity, it will have to be returned to your distributor for repair.</p>
--	---

- Putting the Xtender(s) in operation using the main ON/OFF switch (1)
The Xtender is supplied and is ready for operation. If you require immediate start-up of the inverter when the battery is powered up, the main switch (1) must be in the “ON” position and the configuration {1111} activated.
- Connecting the consumers at the output
Activate the output protection device (F) if existing, and/or press the ON/OFF button (41). The light indicator “AC out” (46) lights up or flashes (in the event of an absence of consumers).
- Activating the input circuit breaker(s) (H)
If an AC source (generator or electrical grid) valid in frequency and voltage is present at the AC input, the device automatically goes into transfer and will start to charge the batteries. The consumers at the output are therefore supplied directly by the power source present at the input.

Your installation is now in operation. If particular configuration or adjustment is required by the system, it is recommended to carry this out immediately. Adjustments must be made with the RCC-02/03 remote control. Please refer to the operating instructions for this accessory.

6.2 DESCRIPTION OF THE MAIN FUNCTIONS

6.2.1 Inverter

The Xtender is equipped with a high-performance inverter which supplies a perfect and very precise sine wave. Any unit designed for the 230 V/50 Hz electrical grid may connect to it without any problem, up to the rated power out of your Xtender. The inverter is protected against overloads and short-circuits.

Thanks to the largely over-dimensioned performance level, loads of up to three times greater than the Xtender's rated output can be faultlessly supplied for short periods of use, thus allowing motors to be started up without any problem.

When the Xtender is operating the LED "ON" (43) is glowing.

When the Xtender is in inverter mode, the LED "AC out" (46) is glowing. If it flashes, the inverter is in "load search" mode (see following chapter "Automatic load detection").

6.2.2 Automatic load detection

In order to save battery energy, the Xtender inverter stops and automatically goes into load search when the detected load is lower than the sensitivity set by the configuration {1187}. It automatically goes back into operation when a power consumer greater than this value demands it. The indicator (46) flashes if the inverter is in "load search" mode, which also indicates that the AC voltage is present at the output in an intermittent form.

The detection threshold for the absence of loads can be adjusted according to the configuration parameter {1187} by means of the RCC-02/03 remote control. When the configuration is set to 0 the inverter will still operate even in the absence of any consumer.

In standby mode the system will thus consume minimal power from the battery (see table of technical data p. 43).

6.2.3 Transfer relay

The Xtender can be connected to an alternative power source such as a generator or public network. When the voltage at the entry satisfies the voltage {1199+470} and frequency {1505-1506} parameters, the transfer relay will be activated after a delay {1528}. This delay may be adjusted(extended) to allow a fully stabile status of the generator before transfer.

When the transfer relay is activated, the voltage present at the input of the Xtender is available at the output for the consumers connected. At the same time the battery charger goes into operation.



When the transfer relay of the Xtender is active, the voltage at the output of the Xtender is equivalent to that which is present at the input and cannot be influenced or improved by the Xtender. The consumers are supplied by the source present at the "AC IN" input via the transfer relay.

The maximum current of the transfer relay is 50 A. This means that the permanent power of the consumers must be a maximum of 11,500 W at 230 V (18000 W for the XTH 8000-48 if Smart Boost {1126} is activated). (see chap. 6.2.6 p. 23). If the battery charger is in operation, part of this power will be used for the battery charge.

The sharing of energy between consumers and the battery charger is adjusted automatically (see chap. 6.2.5 – p. 23). The transfer relay will be deactivated when the input voltage no longer satisfies the configuration {1199} or {1432} min. and max. voltage and frequency at the input or when the current limit {1107} is exceeded, if the exceeding of this limit is prohibited {1436} It then passes immediately into inverter mode. In this case the loads are supplied exclusively by the battery via the inverter (see chap. 6.2.6 – p. 23). This switching always takes place automatically. The presence of increased dynamic loads (such as pneumatic angle grinders, etc.) may lead to an undesirable opening of the transfer relay due to the weakness of the source. To this case, a delay in the opening of the transfer relay can be adjusted with the parameter {1198}.

When the generator stops, the change from transfer mode to inverter mode normally takes place without any interruption of the output voltage. The interruption will be 40 ms in the event of the immediate loss of input voltage at "AC IN" provided the UPS mode {1435} is not deactivated.

6.2.3.1 Fast voltage loss detection mode (fast transfer)

When the Xtender is connected to the public grid or to a generator supplying stable and clean AC voltage, a fast voltage loss detection mode {1435} can be used. In this mode, perturbation or lack of voltage of less than 1 millisecond can be detected, switching the unit in inverter mode immediately. The sensitivity of this detection is adjustable with the parameter {1510}. This mode guarantees a zero or maximum of 15 ms transfer time

This mode should not be used in presence of highly disturbed utility grid or with a low power generator or a generator supplying a poor quality voltage.

6.2.4 Battery charger

The battery charger for the Xtender is completely automatic and is designed in such a way as to guarantee an optimum charge for the majority of the lead-acid or gel batteries. Once the transfer relay is activated, the battery charger goes into operation and the charge indicator (44) lights up.

The battery charger is designed in such a way as to guarantee charging of the battery that is as complete as possible. The charging process is at four levels by default and guarantees optimum charging of the batteries. The charging current is given by the configuration {1138} and can be adjusted continuously from 0 to the nominal value with the help of the RCC-02/03.

i	<p>If the battery voltage is lower than the critical disconnection threshold {1488} operation of the charger will be automatically prevented. Only the transfer relay is authorised to operate in this case. The battery must then be recharged by an external source up to a voltage higher than the critical disconnection threshold in order to allow the Xtender charger to operate.</p>
----------	--

The charge cycle, programmed by default, as shown in the example described in the figure opposite, runs automatically.

The line (28) indicates the development of the battery voltage.

The lower line (29) indicates the battery current (input and output).

The cycle starts with a continuous current charge (a) adjusted by default according to the configuration {1138}. If the ambient temperature is increased

or the ventilation blocked, the current may be reduced and become lower than the selected current. Once the absorption voltage {1156} is reached, the cycle passes to voltage adjustment mode (d), known as the absorption phase, the duration of which is set by the configuration {1157}. The minimum interval between two absorption cycles is limited by the configuration {1161}.

At the expiry of the absorption time, or if the absorption current is lower than the configuration {1159}, the voltage is set to a lower value {1140}. This phase (e) is known as the maintenance or "floating" phase. Due to the limiting function for the input current (see the following p. 22), it is perfectly normal for the charge current to be lower than the selected current if the limit of the AC input current {1107} is reached (b). In this event the AC IN indicator (45) flashes. If the "Smart Boost" function is activated {1126} and the power required by the consumer exceeds the power of the source, the battery will be discharged (c) despite the presence of the grid or the generator. In this

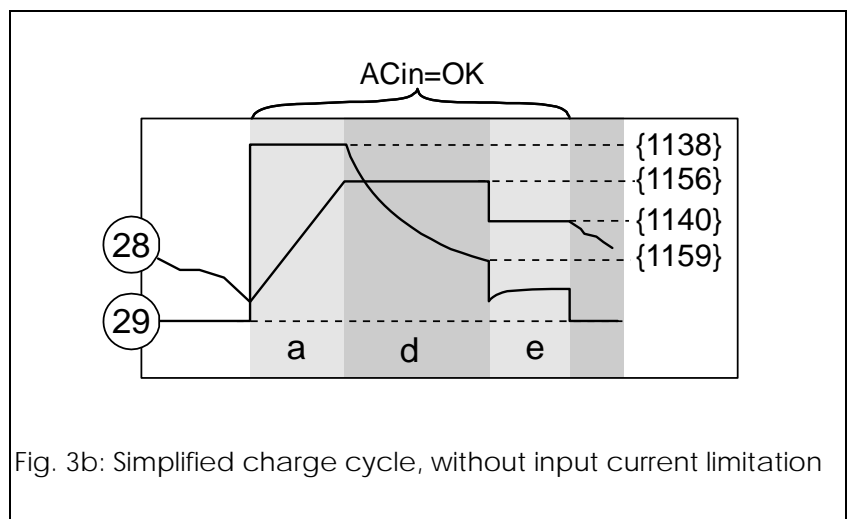

Fig. 3b: Simplified charge cycle, without input current limitation

case the LED “charge” (4) goes out. The consumers must ensure that they have average consumption that is less than the power of the source (generator or public grid) in order to avoid a complete discharge of the battery. These situations are set out in the figure below.

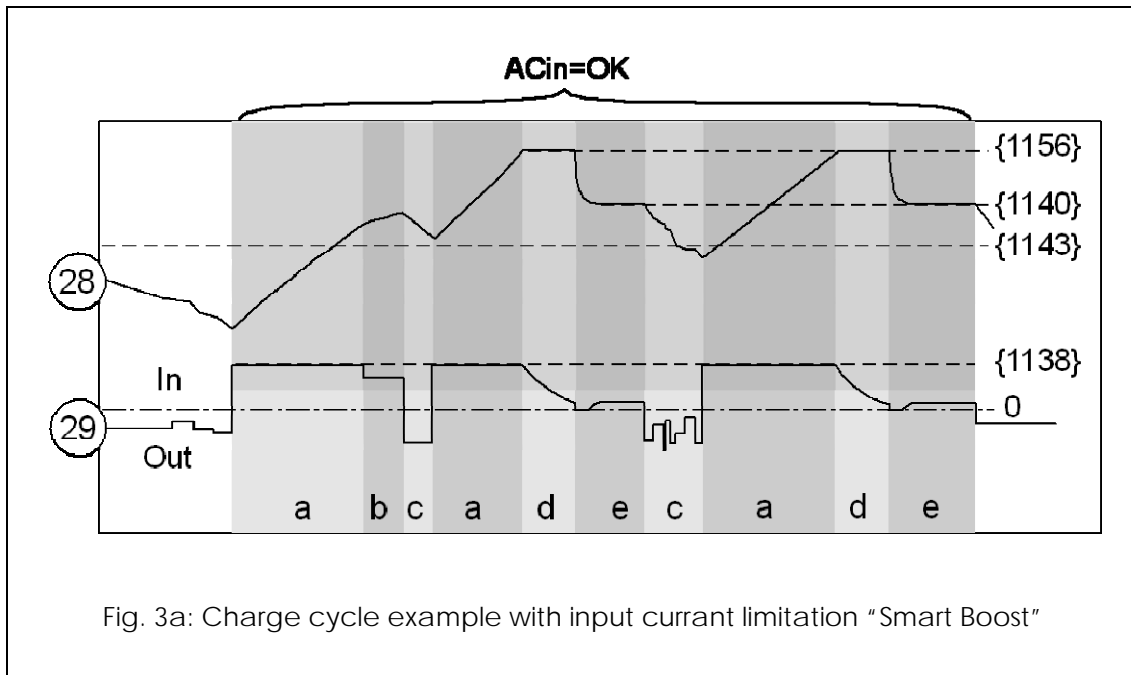

Fig. 3a: Charge cycle example with input current limitation “Smart Boost”

If the BTS-01 temperature sensor is used, the voltage adjustment thresholds for the battery are corrected in real time by means of the battery temperature. The value of this correction is set by the configuration {1139} in the configuration table p. 41.

i Much more complex charge profiles or exclusion of the charger can be configured using the RCC-03/03 remote control.

! Configuration of the battery charger is under the responsibility of the operator. Incorrect configuration that does not correspond to the charging methods of the battery recommended by the manufacturer may be dangerous and/or considerably diminish the battery service life. If the factory settings are modified, it is imperative that the new values be entered in the configuration table p. 41

6.2.5 Limiting the input current by limiting the charger current

In order to best use the resources available at the input (depending on the generator size or the grid output) the Xtender has a system known as power sharing.

This is a system that allows the current of the charger to be limited – from its target value {1138} to 0 – according to the current used at the output in relation to the maximum current available at the input set by the configuration {1107}. The greater the current at the output, the more the part of the current at the input assigned to charging the battery is reduced. If the current exceeds the limit {1107}, the transfer relay will remain closed and the input source is likely to be overloaded bringing the protection device (H) to open. Exceeding the limit can be forbidden by the configuration of the parameter {1436}. If so, if the input current limit {1107} is reached, the transfer relay will be open and the consumer will remain supplied exclusively by the inverter (battery) as long as the output current exceeds the limit of the input current.

This system allows the sharing of power available by giving priority to the AC output (AC out) and to the consumers who are connected to it. The charger will only use the power not utilised at the

output to ensure that the battery is charged. Once the charge current decreases by going into “power sharing” mode, the indicator (45) flashes.

The limit value of the input current is set by the configuration {1107} and may be adjusted via the RCC-02/03 remote control.



In the case of mobile applications the installation of an RCC-02/03 remote control is recommended, in order to be able to adapt the value of the input current limit if necessary, for each connection to a limited grid.



If the power usage at the output is greater than the input limit current value {1107}, the Xtender cannot limit the current. This situation will then lead to the stoppage of the generator due to overloading or will release the upstream protection circuit for the Xtender. This major drawback can be prevented by using the “Smart Boost” function described below. It is also possible to prohibit the beyond going of the current input limit by the parameter {1436} which will then cause the opening of the transfer relay in case of going beyond input limit.

6.2.6 The inverter as source backup (“Smart Boost” function)

The combined usage of the power sharing function and the Smart Boost function allows this drawback to be overcome as mentioned above. The source backup function supplements efficiently the charger current limiting function in order to ensure optimum protection of the fuse upstream of the device. This system proves to be a decisive advantage particularly in all mobile systems (boats, leisure vehicles and service vehicles) that are frequently connected to sources with a limited value such as a portable or camping power supply. Despite a limited source, all the greater power applications downstream of the Xtender remain functional.



When this function is activated, the battery can be fully discharged despite the presence of the grid or the generator. The average power consumed by the user must not exceed the power of the source, at the risk of discharging the battery.

The Smart Boost function is deactivated by default. To activate the function the RCC-02/03 remote control is required. When this function is activated {1126}, it allows the current from the battery to be supplied to the user in order to guarantee that the current at the input of the device does not exceed the limit set {1107}.

If the input current limit is exceeded, the transfer relay will be opened immediately, thereby protecting the upstream protection device. If the exceeding of the input current value limit is due to a short-circuit downstream, the transfer relay will remain activated and the protection upstream of the Xtender (H) will be requested.

The installation cabling must take this particular function into account, which allows a current equivalent to the sum of all power outputs in the inverter and the AC source to be available at the output.

If you have, for example, a 5 kW (22 A) source and an Xtender of 5 kW, the power available at the output will be 10 kW. The downstream cabling must therefore be dimensioned accordingly. In this example, the output cable must be dimensioned to support a current of 45 A. A dimensioning table, fig. 1a, will help you to determine the output currents that dimension the protection devices and the cable sections to be applied.



If the Xtender is connected to a generator, this must have a power at least equal to half of the power of the Xtender(s) to which it is connected.

6.2.7 Input current controlled by input voltage

When AC sources with variable power are connected to the Xtender's ACin, a particular parameter setting insure a permanent availability of the nominal power at the Xtender's output thanks to the Smartboost function. It's notably the case with "Dynawatt" 230Vac alternator coupled with variable speed traction engines. These kinds of sources have a variable voltage according to the available power. For this type of application, it's necessary to activate the parameter {1527}. So, the input current limit {1107} will be regulated between zero to the programmed value, for an input voltage which varies between {1309} and {1309}+{1433}

6.2.8 Battery protection

The battery is protected in all cases against deep discharge. The indicator (52) flashes once when the battery has reached the disconnection threshold {1108} and the inverter will stop some time after {1190}. This threshold can be dynamically corrected {1191} with an advanced algorithm that computes automatically the battery voltage compensation in function of the instantaneous power. This correction may also be manually fixed {1532} by setting the low voltage disconnection at full load {1109}. These dynamic corrections can be deactivated by setting the parameter {1191}. The inverter will stop immediately if a critically low voltage value set by the configuration {1188} is reached. The inverter will restart automatically when the battery voltage has reached the restarting threshold {1110}.

This restarting threshold {1110} can be automatically readjusted if the parameter {1194} is activated, in order to better protect the battery against repeated cycling in an "almost empty" state of charge. The restarting threshold is then incremented {1298} up to a maximum value {1195}, whenever the LVD (low voltage disconnection) is reached. The restarting threshold will be reset to its initial value when the value of parameter {1307} is reached.

If the inverter is repeatedly {1304} encountering a low voltage disconnection in a short period {1404}, it will stop permanently and will only start again via an operator's manual restart.

6.2.9 Xtender protection

The Xtender is protected electronically against overloads, short-circuit, overheating and reverse current (cabling of a voltage source on AC out).

In the event of overload or short-circuit at the output, the inverter stops for some seconds and restarts. If the inverter is repeatedly encountering this situation {1300} in a short period, it will stop permanently and will only start again via an operator's manual control.

If the battery voltage exceeds the value set by the configuration {1121} the inverter stops and starts up again when the voltage is less than {1110}. If the Xtender is repeatedly encountering this situation {1303} in a short period {1403}, it will stop permanently and will only start up again via an operator's manual control.



A battery voltage greater than 1.66 x the nominal voltage may lead to significant damage or destroy the device.

Overheating of the Xtender, Insufficient ventilation, increased ambient temperature or obstructed ventilation may lead to overheating of certain internal components of the unit. In this case, the device will automatically limit its power output as long as this abnormal situation persists.

The Xtender is protected from reverse polarity by means of an external fuse installed on the battery.

6.2.10 Auxiliary contacts

The Xtender has two dry reversing contacts that are potential-free. The status of the contacts in idle mode (deactivated) is indicated by the annotations, N.C. = normally closed and N.O. = normally open.

Maximum contact loads: 230 Vac / 24 Vdc: 16 A or: max. 50Vdc/ 3A

These dry contacts are programmed by default for the following functions:

Contact no. 1 (AUX 1): The contact has a function of automatic start of generator (two wires). The contact will be activated when the battery voltage is below a value, during a given time fixed by parameters {1247/48}/{1250/51}/{1253/54} The contact will be deactivated or when the charge cycle has reached floating, or when the "Aux. 1 deactivation voltage" {1255} is reached during a predetermined time {1256}

	<p>The voltage of the battery is automatically compensated according to the instantaneous battery current the same way as it is done for compensation of LVD (see chapter 6.2.8 - p.24) if parameter {1191} is activated.</p>
---	---

Contact no. 2 (AUX2) : alarm contact by default. It is deactivated when the inverter is out of service or is working at reduced performance, either because of manual control or if there is an operational fault such as overload, undervoltage of the battery, overtemperature, etc.

The functions of the two auxiliary contracts can be modified and programmed variously with the help of the RCC-02/03 control.

If the operator or installer requires different behaviour for the auxiliary contacts, they are both freely and individually programmable depending on the battery voltage and the inverter status and the internal clock.

The intelligent programming of the auxiliary contacts allows many applications to be considered such as:

- Automatic startup of the generator (two or three wires)
- Automatic load shedding of the inverter (2 sequences)
- Global or individual alarm
- Automatic disconnection (load shedding) of the source

6.2.11 The real time clock

The Xtender has a real time clock that allows the functioning of the auxiliary contacts to be managed, in particular. This clock must be adjusted via the use of the RCC-02/03 remote control.

6.2.12 Entry command (Remote control on/off)

This function is available as a standard on XTH series. It is available on the series XTM by means at the external module RCM-10 in option. See chap. 6.4.3 p.29.

This entry is to drive one or more function that you can choose thru programming of the RCC-02/03. the function is activated or by opening /closing a potential free contact or by applying a voltage (Max. 60 V eff./30mA) across the terminal block. The jumper (6) must be correctly positioned according to the chosen variant as described in the figure opposite.

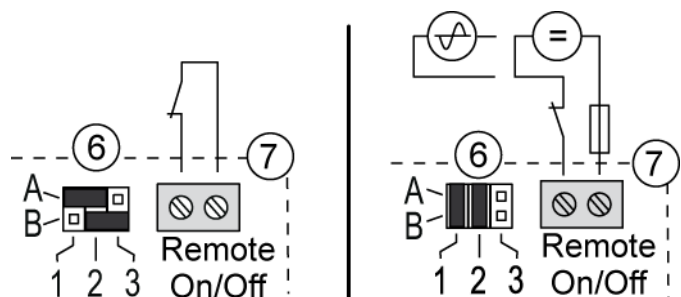

In multi-unit configurations (see below) the chosen functionality must be the same in every unit in the system. Only one unit can be wired to apply the function to every Xtender in the system. If the entry command is used as an emergency stop, (all functions halted) it has to be wired on the unit with the highest serial number (master).

6.3 MULTI-UNIT CONFIGURATIONS

Several Xtenders can be used in the same system, either to create a three-phase system or to increase the power output of a single or two phases. The implementation of this configuration requires particular precautions and it must be installed and commissioned by qualified personal only.



When multi-unit system is commissioned, the software's version of every units will be automatically checked and units may refuse to start in case of incompatibility. If so, an upgrade of every units is be required with the RCC-02/03 and the last software version available by the manufacturer. (Read the RCC-02 user's manual to perform this operation).



In Multi-units system every Xtender in the system shares the same battery bank.

The inverters selected must be of the same type and the same rated power output. There is a shared battery bank.

In these multi-unit systems, the units must be interconnected via a communication bus connected to the connectors (3) by cable (art. no. CAB-RJ45-2) of a maximum length of 5 metres. Interrupting this connection in a multi-unit system will lead to the stoppage – after 5 seconds – of all the units in the system.

Various application examples are described from fig. 12 to fig. 19 of Appendix I.



It is important to read and adhere to the descriptions associated with each of the figures mentioned above



In multi-unit system, it is not recommended to employ the manual setting {1532} of the LVD dynamic correction.

In configurations carrying several Xtenders, each unit is controlled independently using the ON/OFF push button (41). When the on/off control is given via the RCC-02/03 remote control, it is applied simultaneously to all units.

6.3.1 Three-phase system

Three Xtenders of the same type can be used and combined in order to establish a three-phase grid. An example of cabling in three-phase is given at figs. 13.-14.

When 3 Xtenders are cabled to form a three-phase grid, the cabled phases at the input determine the jumper position for selecting the phase (10). It is vital to determine and select the phase for each Xtender. If the grid is not available at the input of the master unit (phase 1), all the units of the system will switch to inverter mode. If only a single-phase source is available, it must be connected to phase 1. The other two phases will therefore be supplied by the other two working units in inverter mode.

6.3.2 Increasing the power by paralleling units

Up to three Xtenders can be cabled in parallel in order to increase the system's rated power output. In this configuration, all the ACin inputs of the Xtender must be cabled. The most recent unit (according to the serial number) in the phase will act as the master and will decide on the operation or suspension of the units in parallel according to the consumer's power demand. The yield of the installation is therefore still optimal.

It is possible to deactivate the master/slave mode with the parameter {1547}. In that case, the search mode is disabled.

An example of parallel connection is given in fig.12 Appendix 1 and the comments on p. 33.

6.3.3 Combined system

It is possible to combine a three-phase system with one or several phases made up of 2 or 3 Xtenders in parallel. An example of cabling is given at fig. 15.

A combination of more than one inverter on only one (or two) phase is also possible. For example, it's possible to build up one powerful phase for the most single phase consumer and the 2 other phases with only one Xtender each for the 3 phase (motor) application as in the example Fig 15 Appendix I

It is therefore possible to combine up to nine Xtenders by running three Xtenders in parallel in a three-phase grid. Examples of cabling are given in figs. 16 to 18 Appendix 1 and the comments on p. 33.

6.4 ACCESSORIES

6.4.1 Control centre and display RCC-02/03 (remote control)

An RCC-02/03 remote display and programming unit can be optionally connected to the Xtender via one of the two RJ45-8-type "Com. Bus" (3) connectors.

These connectors may only be used for connecting a CAN-ST compatible accessory, excluding any other connection such as LAN, Ethernet, ISDN, etc.

The RCC-02/03 control centre is vital for modifying device configurations.

It also allows the following functions:

Display of function synopsis

Display of the measured operational values (current / voltage / power output, etc.)

Updating of software or implementation of customised software

upload/download of inverter configuration

Updating of inverter configurations

Events logging of error message

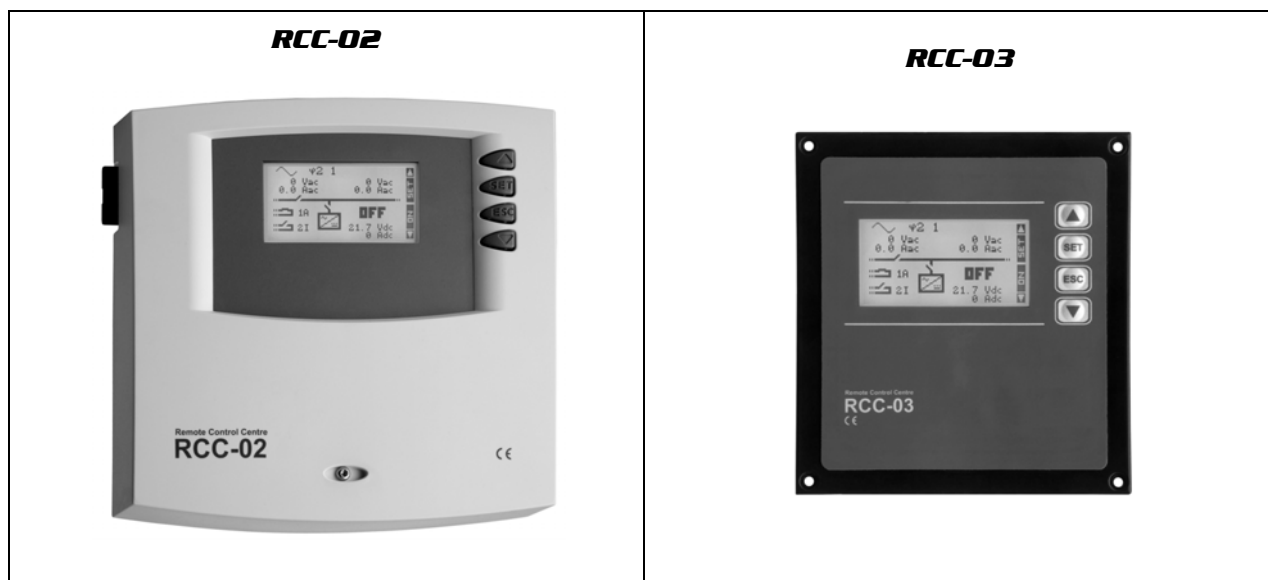

The features of the RCC-02 and the RCC-03 are the same. They only differ in their external appearance. The RCC-02 is designed for wall mounting, whereas the RCC-03 is designed as a board device.

The RCC-03 model must be taken off the table to allow access to the SD card slot (during updating, for example).

Model N°: RCC-02: Dimensions: H x W x D // 170 x 168 x 43.5mm

RCC-03: Dimensions: H x W x D // 130 x 120 x 42.2mm



The two remote control models are delivered with a 2 m cable by default. Cables of specific lengths (5 m, 20 m and 50 m) can be ordered. The article no. is as follows: CAB-RJ45-xx. The length in metres is specified as xx

Up to 3 RCC-02/03 remote controls can be connected in series on the communication bus of one Xtender or an Xtender multi-inverter system. In a system comprising a single Xtender, the connection of the RCC-02 or RCC-03 may be conducted without stopping the Xtender (warm). When connecting an RCC-02/03 remote control in a multi-unit system, it is recommended that all units in the system be stopped and that the communication bus on the device on which the connection is being made be terminated.



The 2 switches for the communication bus termination, "Com. Bus" (4) both remain in position T (terminated) except when both connectors are in use. In this case, and only in this case, both must be placed in the O open position. If one of the two connectors is not in use, the two termination switches (14) will be in position T.

6.4.2 BTS-01 temperature sensor

The optimal operating voltages for lead batteries vary depending on the temperature. A temperature sensor is optionally available to correct the battery voltage and guarantee an optimum charge whatever the battery temperature. The correction factor given by the correction of the sensor is set by the configuration {1139}

Article no. for the temperature sensor (including a cable of 3 m): BTS-01.

Dimensions: H x W x D / / 58 x 51.5 x 22 mm



6.4.3 Remote control Module RCM-10

The optional remote control module for XTM range gives the possibility to have the 2 following function:

Main ON/OFF (1) see chap.7.1 below.

This operation can only be controlled by a potential free contact.

Command entry (7) see chap. 6.2.12 – p. 25.

This module can be plugged on DIN rail Article n°: RCM-10

Supplied with a 5m cable (max. length 5m).

Dimensions: 45 x 78mmH

Height on rail: 40mm

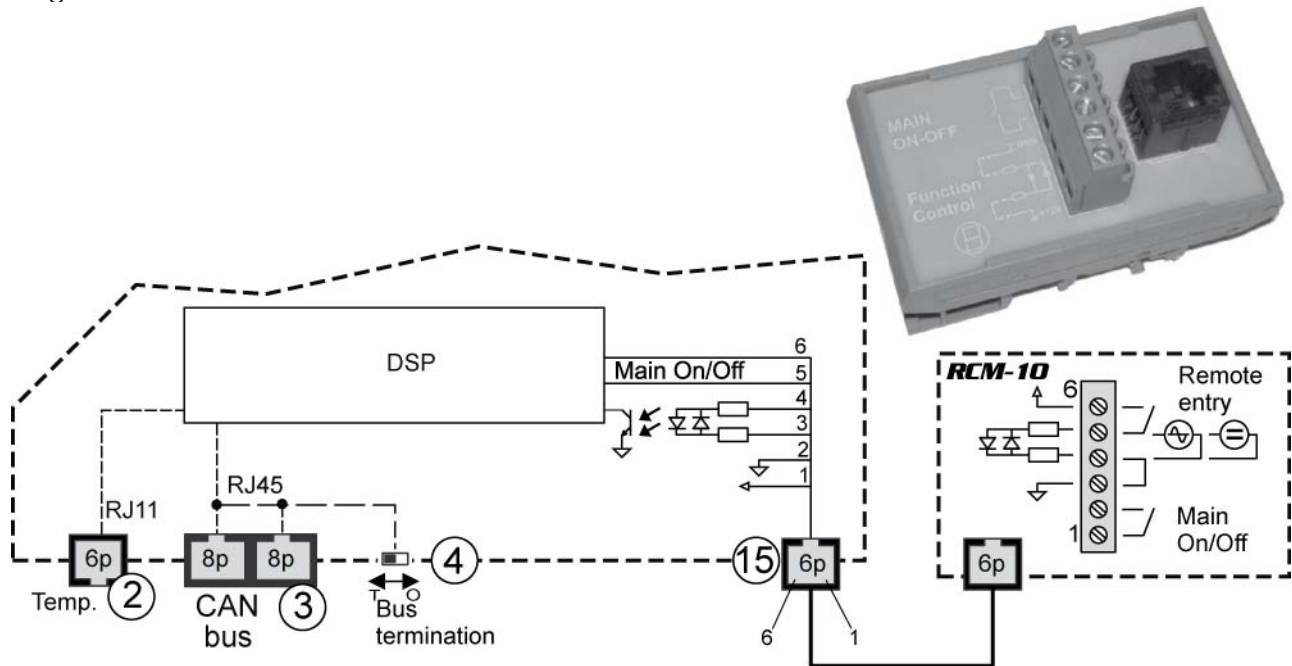

It is also possible to access to these functions by a direct cabling on the RCM-10 plug of the device (15) as per the opposite pictures.

Figure a : function input by dry contact as per chap. 6.2.12– p.25.

Figure b : function input by a voltage as per chap. 6.2.12– p.25.

The main on/off (1) can only be controlled by a potential free contact.

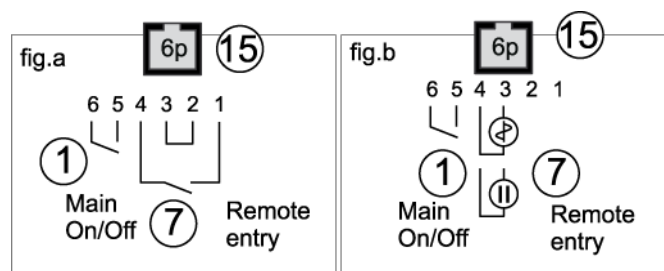

7 CONTROL

7.1 MAIN ON/OFF CONTROL

This switch (1) interrupts the electronic supply and all the Xtender peripherals. The residual consumption on the battery is therefore less than 1 mA.

The ON/OFF switch is used only for the complete stoppage of the whole system. This switch is not available in the XTM. The function can be added with the use of the remote command modul RCM-10.

7.2 DISPLAY AND CONTROL PANEL

The Xtender has a ON/OFF button and light indicators at the front of the unit, allowing clear identification of the operating mode.

(41) The ON/OFF button allows the start-up or complete stop of the system. In the systems comprising several units, each unit is started or stopped individually. For a simultaneous start-up of all the units use the dry contact control (see chap. 6.2.12 – p. 25) or the ON/OFF button of the RCC-02/03 remote control.

	<p>Even when the equipment has stopped, dangerous voltages may be present at the Xtender input.</p>
---	---

(42) This indicator lights up when the equipment has been stopped manually using the ON/OFF button (41). It also allows the cause of an unintentional stoppage of the device to be indicated via the different flashes, the imminence of a stoppage or the temporary limitation of its performance. The table below describes the type of fault according to the number of flashes on the indicator (42)

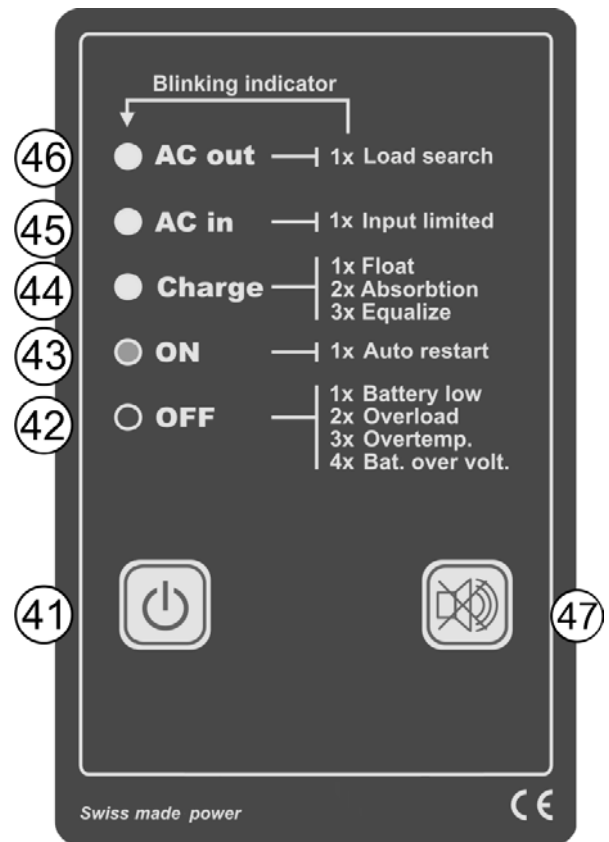

	Indicated alarm	Comment
1x	(Imminent) stoppage as a result of low battery voltage.	If the device has not yet stopped, it is recommended to disconnect all non-priority consumers and/or start up the generator. If the Xtender has stopped it will restart automatically when the battery voltage has reached the correct value again {1110}. It can be restarted manually using the ON/OFF button (41) as long as the battery voltage is higher than the critical threshold {1488}. See also chapter 6.2.9 – p. 24.
2x	Stoppage due to overload in the equipment, due to either a short-circuit or too high a load for the inverter.	In this event the equipment will make several attempts restart {1133} every few seconds and will stop if the overload remains (see chap. 6.2.9 – p. 24). It is vital to eliminate the cause of the overload without restarting. Restarting is carried out manually by pressing the button (41).
3x	Decrease in the rated output of the device due to a too high internal temperature.	This may be due to too great a load for the device, at too high an ambient temperature or counteracted or obstructed ventilation. The power output of the device will therefore be limited to around 50% of the Pnom. including in charger mode or Smart Boost mode.
4x	Battery voltage higher than the maximum limit set by the configuration {1121}.	Check the cause of this excess voltage. The equipment will restart automatically when the voltage falls below the threshold value {1122}. see chap. 6.2.9 – p. 24
5x	No transfer. Insufficient power from the source	In this case, the Xtender remains in inverter mode until the output power decrease below the input limit and does not allow the transfer relay to close. You must increase the input current limit {1107}, or authorise the exceeding of this limit {1436} or authorise backup on the source {1126}, or disconnect some consumers (decrease of loads).
6x	Startup prevented due to unwanted voltage at the device output.	Voltage is present at the device output. Check your cabling: correct the fault and start the installation again using a manual control on the button (41).
7x	Indicates missing voltage on one of the units of the system in a multi-unit configuration.	Check the input protection devices (H) for all the system units.
8x	Software incompatibility in a multi-units system	The software version of all units in the system must be harmonised. Proceed according to the RCC-02/03 user manual to upgrade the software.
9x	Loss of synchronization between the units	Failure of the link between the units. Check the presence and the state of the communication cables between units.

(43) This indicator is glowing continuously when the device is working.

It flashes when the equipment is temporarily stopped due to a fault displayed by the indicator (42) or a ON/OFF control cabled at the "Remote ON/OFF" input (7), or when the equipment is intentionally put to idle mode by the master unit in a multi-inverter parallel system (see chap. chap.6.3.2 - p. 26).

	<p>The equipment will restart automatically when the conditions that led to the temporary stoppage have gone away.</p>
---	--

In the systems with multiunits in parallel, the indicator (43) blinks 2 times when the Xtender is temporarily stopped by the master unit of the concerned phase while this mode is authorized. {1547}.

(44) This indicator is glowing continuously when the charger is working and has not yet reached his absorption phase.

It flashes twice during the absorption phase and once during the floating phase.

If the Smart Boost mode has been activated, this indicator goes out temporarily when source backup is required by users (loads).

(45) This indicator is glowing continuously when a n alternative voltage with correct values, either in frequency {1112-1505-1506}, or in voltage {1199} is present at the AC IN input of the device and the current limit set by the user has not been reached. It flashes when the current limit at the input {1107} set by the user has been reached. In this case the charger current is reduced in order to guarantee priority supply to the users (see chap. 6.2.5 p. 22). If the input current is exceeded nevertheless, the Xtender goes back to inverter mode (transfer relay open) and the indicator (42) will keep flashing as long as the user current exceeds the limit value of the input current {1107}.

If the Smart Boost mode (see chapter 6.2.6 – p.23) is used and the inverter is part of the user supply – therefore the battery is discharged – the “charge” indicator (44) will be glowing.

(46) This indicator is glowing continuously when an alternative voltage of 230V is present at the equipment output. It flashes when the device is in “load search” mode according to chapter 6.2.2 – p. 20.

(47) Receipt button to stop the acoustic warning (XTM only). The duration of the acoustic alarm {1565} is factory settled to 0 sec (deactivated).

8 MAINTENANCE OF THE INSTALLATION

With the exception of the periodic checking of connections (tightening and general condition) the Xtender does not require any special maintenance.

9 PRODUCT RECYCLING

The model of the Xtender series conform to the European directive 2002/95/EC on hazardous substances and does not contain the following elements: lead, cadmium, mercury, hexavalent chrome, PBB or PBDE.

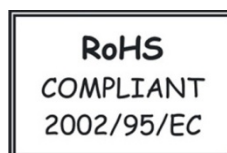

To dispose of this product, please use the service for the collection of electrical waste and observe all applicable obligations according to the place of purchase.



10 EC DECLARATION OF CONFORMITY

The inverter and accessories described in this manual comply with the following directive and standards:

Dir. 89/336/EEC:

EN 61000-6-1, EN 61000-6-3, EN 55014, EN 55022, EN 61000-3-2, 62040-2,

LVD 2006/95/ EEC :

EN 62040-1-1, EN 50091-2, EN 60950-1.

CH -1950 Sion, 31 January 2007

STUDER Innotec (R. Studer)



11 COMMENTS OF APPENDIX DRAWINGS

Fig.	Description and comment
1a	Dimensioning table for the downstream protection device (F). This table helps to size the Xtender upstream and downstream protection devices. Due to the source assistance function, it should be outlined that the downstream protection can be of higher gauge than the upstream one.
1b	Type plate and series no. See chapter 16 - p. 40. The intactness of this label is vital for any possible warranty claims. It must not be altered or removed.
2a	Dimensions and fastening the device The support (wall) must be appropriate for supporting the increased weight of the device without any risk.
2b	Installation distance Insufficient distance or an increased ambient temperature can reduce the rated power output of the device.
3a	Battery charge cycle Charge cycles that are more complex than those described in chap. 6.2.4 – p. 21 of this manual may be programmed via the RCC-02/03 remote control.
3b	Simplified battery charge cycle: See chapter 6.2.4 - p. 21.
4a	Device connection box See chapter 3.6.2 – p. 9.
4b	Control panel See chapter 7.2-p. 30.
5a	12 V battery: connection in series and in parallel / series for 2 V cell
5b	12 V battery: connection of 12 V battery in parallel
5c	24 V battery: connection in series and in parallel / series for 2 V cell
5d	24 V battery: connection in series and in parallel / series for 12 V battery block
6a	48 V battery: connection in series and in parallel / series for 12 V battery block
6b	48 V battery: connection in series for 12 V battery block
6c	48V battery: Series connection of 2V cell
6d	48 V battery: connection in parallel / series for 2 V cell
7	Xtender circuit diagram
8a	Single-phase installation (AC and DC part) This example illustrates the most routinely used installation, allowing the attainment of an emergency system or a hybrid system (remote sites) ensuring the supply in single-phase from a generator and/or the battery when the AC source is absent. See also chapter 4.1.1.1 / 4.1.1 – p. 11.
8b	Command entry variants (ON/OFF remote control) This example illustrates the various possibilities for connecting the entry command (remote ON/OFF on former version) terminal block (7), enabling to controls the programmed function (See also chap.6.2.12 p.25.) with a dry contact or a voltage source (max 60V eff./30mA) The maximum length for this control should not exceed 5 m.
8c	Installation with three-phase source and secured single-phase output – AC and DC part In this example, the three-phase users will only be supplied when the generator or grid are operating.
9a	Fixed installation with plug connection to the single-phase source – AC part Special feature: The connection of the neutral upstream and downstream of the Xtender (C) is prohibited in this configuration (presence of a plug upstream). See also chapter 4.2 – p. 11.

Fig.	Description and comment
9b	Fixed single-phase installation with connection by plug to a three-phase source – AC part Highlight(s): The connection of the neutral upstream and downstream of the 'Xtender (C) is prohibited in this configuration (presence of a plug upstream). See also chapter 4.2 – p. 11.
10a	Example of installation in a vehicle (AC part) Highlight(s): The connection of the neutral (C) is not permitted (presence of a socket upstream). The earth-neutral connection is absent in inverter mode (neutral stand-alone system). The safety is guaranteed by the equipotential bonding (frame). The automatic re-establishment of the earth-neutral connection downstream of the device in inverter mode can be programmed. Consult the table of figures, item (V). See also chapter 4.2 – p. 11.
10b	Example of installation in a boat without an isolation transformer (AC part) Highlight(s): Where there are multiple sources, for example connection to the dock and on-board generator, a source reverser (X) guaranteeing switching with phase and neutral interruption must be installed.
10c	Installation example in a boat, with isolation transformer Characteristic: With several power sources, like shore connection and onboard generator, a switchover (X) must be installed, to safely switch between the different voltage supplies with guaranteed interruption of the phase and neutral conductors. Moreover, an earth must be formed (E) after the isolation transformer.
11	Example of a hybrid installation: This is the most common system used to establish an emergency system or a hybrid system (grid-remote sites) ensuring a single-phase supply from a generator and/or the battery. Highlight(s): In a hybrid installation, the sources for recharging a battery (k-m) are connected directly to the batterie via their own control system. This does not interfere with the Xtender charger. See also chapter 4.1.1 – p. 11.
12	Example of parallel connection of 2 or 3 Xtenders Only Xtenders of the same power output may be connected in parallel. Wiring precautions: The cable lengths and cross-sections of AC in input (A) and AC out output (B) must be the same for all inverters in parallel in the same phase. Variant: The sum of the lengths of the cables (A1) + (B1) of Xtender 1 must be the same as the sum of the lengths of the cables (A1) + (B1) of Xtender 2, and ditto for Xtender 3 The AC input for each Xtender must be protected individually by a protection device (H) of the appropriate size. The protection device at the output of the Xtender (F) can be shared and of appropriate calibre at the sum of the currents of the devices in parallel. In a multi-unit system, the functionality dedicated to the command entry (chap. 6.2.12 p.25) must be the same for every unit. One unit only have to be wired and the function is applied to every unit of the system.
13	Example of three-phase cabling of 3 Xtenders – three-phase input Highlight(s): When 3 Xtenders are cabled to form a three-phase grid, the cabled phases at the input determine the jumper position for selecting the phase (10). It is vital to determine and select the phase for each Xtender. See also chapter 6.3.1 – p. 26. The comments for fig. 12 - 4 to 6 are valid.
14	Example of three-phase cabling of 3 Xtenders – single-phase input Highlight(s): In a three-phase configuration, if only one phase is available as a source, only one Xtender will be wired on that source. Phase 2 and 3 will be permanently fed from the two other units connected only to the battery (not connected to ACin). It is vital to determine and select the phase for each Xtender. See also chapter 6.3.1– p. 26. The comments for fig. 12 are valid.

Fig.	Description and comment
15	Example of three-phase, input and output wired, with reinforced phase Highlight(s): This installation allows a three-phase supply with a reinforced phase The reinforced phase may be incorporated on two or even three inverters in parallel. The protection device at the output on which 2 or 3 Xtenders are cabled must be calibrated according to the sum of the maximum currents of the devices in parallel. The comments for fig. 12 to 13 are valid.
16	Example of cabling of 9 Xtenders in three-phase and parallel – AC part Special feature: In fixed high power installations, it is advised that a shared neutral be retained, distributed to all parties in the grid (see (C)) The comments for figs. 12 to 15 are valid.
17	Example of cabling of 9 Xtenders in three-phase and parallel – DC part (distribution bar)
18	Example of cabling of 9 Xtenders in three-phase and parallel – DC part in star formation
19	Connection of remote controls RCC-02/03 At a Xtender or at a system with several Xtender maximally 3 remote controls can be attached.

12 DRAWING'S ELEMENTS (DC PART)

Elem.	Description	Comment
a	RCC-02/03 remote control	This device allows complete configuration of the installation as well as displaying the system behaviour. It is recommended but not necessary for the installation to function well. See chapter 6.4.1 – p. 27.
b	Battery	The battery capacity is constituted according to figures 5a to 6d based on the required voltage. Note: It is vital that the voltage and the polarity of the battery be checked before connecting to the inverter. An overload or incorrect polarity could seriously damage the Xtender. Correct dimensioning of the batteries is essential for trouble free operation of the system. See chapter 4.3.1 – p. 13.
e	Communication s cable	Communications cable. Only an original cable supplied by Studer Innotec may be used. The total length of the communications cable must not exceed 100 m for 3 x RCC-02/03 or 300 m for a single RCC-02/03.
f	Protection devices	A fuse-type device, thermal circuit breaker or magnetic-thermal circuit breaker (see fig. 8a) must be installed on at least one of the two battery conductors. It will ideally be placed on the positive pole of the battery and as close as possible to this. The calibre of the device is selected according to the cable section used. If the negative pole of the battery is not earthed, it must also be protected by such a device.
h	Distribution bar	Positive pole of the battery
j	Distribution bar	Negative pole of the battery
k	Wind-powered or/and micro-hydro generator	One or more wind-powered generators or/and micro-hydro with their own regulation system may be used to directly charge the battery. Its dimensioning does not depend on the Xtender and does not interfere with it.
L		
m	Solar generator	One or more solar-powered generators with their own regulation system may be used to directly charge the battery. Its dimensioning does not depend on the Xtender and does not interfere with it.
r	Entry command control via dry contact	A control device may be connected to the terminals (7) of the Xtender. See chapter 6.2.12 – p.25. The length of the connection cable must not exceed 5 m.
t	BTS-01 temperature sensor	The sensor is placed in immediate proximity to the battery. If the installation comprises several Xtenders, a single sensor is connected to one of the units. See chap. 6.4.2 p.28

13 FIGURE ELEMENT'S (AC PART)

Elem.	Description	Comment
A	Input supply cable	The section is determined by means of the maximum current at source and the protection device (H). In multi-unit systems, cables (A) of the same phase must have the same length and section (see comment fig. 12-2/3).
B	Output supply cable	In multi-unit systems, cables (B) of the same phase must have the same length and section (see comment fig. 12-2/3). The section must be selected by means of the Xtender's output current given on the type plate and the protection device selected for the input (see fig. 1a).
C	Connection of the neutrals	See chapter 4.1.4 - p. 11. In a fixed installation where the neutral is connected to the earth at a single installation point upstream of the Xtender, it is permissible to carry out a connection of the neutrals in order to preserve an unchanged earthing system downstream, independent of the operating mode of the Xtender. The downstream protecting ground fault device. This connection (C) is not permitted if a socket is installed upstream of the Xtender.
D	Differential circuit breaker	A protection device must be installed downstream of the source (G or U) according to the local requirements and in compliance with the applicable regulations and standards.
E	Earth-neutral connection bridge	The neutral is earthed at a single point of the installation, downstream of the source and upstream of the protection device(s) at the default current (DDR). When several sources are available, each source must have an earthed neutral. If the source has to be retained with an isolated earthing system (IT) the applicable local provisions and regulations must be applied.
F	AC output protection devices for the Xtender	A protection device dimensioned in dependence of the cable section used may be installed downstream of the Xtender (main circuit breaker before distribution). The cable section is to be dimensioned according to the calculation table of maximum output current (fig. 1). The Xtender has an internal current limitation the value of which is stated on the type plate Fig. 1b (35).
G	Generator	The generator is dimensioned according to the requirements of the user. Its rated current will determine the configuration adjustment {1107} "maximum current of the AC source".
H	Protection devices at the Xtender input	The protection device at the input of the Xtender must be dimensioned according to the power output of the source at the cable section used. It will not exceed a calibre equivalent to the input current "I AC in" given on the type plate of the unit Fig. 1b (35).
K	Connection plug / socket	If the Xtender is connected to an AC source by means of a plug, the connection cable must not exceed a length of 2 m, and the socket must remain permanently accessible. The socket will be protected by a protection device of appropriate calibre. The connection of the neutrals (C) is prohibited in this case.
S	Secured grid	Distribution to the users supplied by the grid or the generator when this is present or by the Xtender within the limit of its power output from energy stored in the battery. This distribution is carried out in conformity with the local standards and regulations.
T	Non-secured grid	Distribution to users supplied exclusively via the present grid or the generator. This distribution is carried out in conformity with the local standards and regulations.

Elem.	Description	Comment
U	Public grid	The connection to the public grid imposes adherence to the local standards and regulations at the responsibility of the installer. The installation should, in principle, be checked and approved by an official body.
V	Automatic earth-neutral connection	This connection is deactivated by default. It may be used in certain specific cases for automatically re-establishing the neutral system type TT (TNC, TNS, TNC-S) when the Xtender is in inverter mode. The activation is carried out via RCC-02/03 remote control configuration {1485}. This operation may only be carried out by qualified personnel, under the responsibility of these personnel, and in conformity with the local standards and regulations. See 4.2.3– p.12
W	Galvanic isolator	This device (optional) is generally used to reduce the risk of electrolytic corrosion due to the direct current when a boat is connected at the dock.
X	Source reversing switch	When the installation has more than one supply source, it is necessary to install a switching device between the sources, simultaneously switching the neutral and the phase(s) of these sources. In all cases this device (manual or automatic) must guarantee interruption of the connected source before its connection to another source.
Y	Isolation transformer	This device (optional) prevents the risk of galvanic corrosion due to direct currents when a boat is connected at the dock.

14 ELEMENTS OF CONNECT CABINET (FIG 4A)

Pos.	Denomination	Description	Comment
1	ON/OFF Main switch	Main on/off switch	See chapter 7.1 - p 29.
2	Temp. Sens	Connector for the battery temperature sensor	See chapter 6.4.2 – p. 28. Only connect the original Studer BTS-01 sensor
3	Com. Bus	Double connector for connecting peripherals such as the RCC002/03 or other Xtender units	See chapter 4.5.9 – p. 17. The two termination switches (4) for the communication bus <u>both</u> remain in position T (terminated) <u>except</u> when <u>both</u> connectors are in use.
4	O / T (Open / Terminated)	Switch for terminating the communication bus.	
5	--	3.3 V (CR-2032) lithium ion type battery socket	Used as a permanent supply for the internal clock. See chapter 6.2.11 - p 25.
6	--	Jumper for programming the off/on switch by dry contact	See chapter 6.2.12 – p. 25 and fig. 8b point (6) and (7). They are positioned at A-1/2 and B-2/3 by default
7	REMOTE ON/OFF	Connection terminals for dry on/off remote connection.	See chapter 6.2.12– p. 25).
8	AUXILIARY CONTACT	Auxiliary contact	(See chapter 6.2.10– p. 24) Take care not to exceed the admissible loads
9	--	Activation indicators for auxiliary contacts 1 and 2	See chapter 6.2.10– p. 24
10	L1/L2/L3	Phase selection jumpers.	See chapter 6.3.1. – p.26. Jumper default at position L1
11	+BAT	Positive pole battery connection terminals	Carefully read chapter 4.5 – p.14 Take care with the polarity of the battery and when tightening the clamp.
12	-BAT	Negative pole battery connection terminals	

Pos.	Denomination	Description	Comment
13	AC Input	Connection terminals for the alternative power supply (generator or public network)	See chapter 4.5.7 - p. 17. Note: It is imperative that the PE terminal be connected.
14	AC Output	Connection terminals for the device output.	See chapter 4.5.6 - p. 17. Note: Increased voltages may appear on the terminals, even in the absence of voltage at the input of the inverter.
17	--	Supplementary terminal for protective earth	This terminal can be used if the required earth cable cross-section is too big to be connected in the terminal 13 or 14
18	--	Mounting hook-up	
19		Access shutter to the top fastening screw.	Full tightening of the top fastening screw may be required in mobile application or in case of heavy vibration of the support of the apparatus.

15 CONTROL AND DISPLAY PARTS FOR THE XTENDER (FIG. 4B)

See chapter 7.2 - p. 30.

Pos.	Denomination	Description	Comments
41		ON/OFF button	The ON/OFF button allows the start up or complete stoppage of the system such as it has been programmed. When there are several units in the same system, each unit must be started up or stopped individually using this button.
42	OFF	Light indicator for stoppage of the unit	When the light indicator flashes it indicates the cause of the stoppage of the unit, its imminent stoppage or the limitation of its rated power output according to chapter 7.2 - p.30.
43	ON	Light indicator showing that the equipment is in operation	This indicator is glowing continuously when the device is working. It flashes when the equipment is at a temporary stop. Note: The equipment will restart automatically when the conditions that led to the temporary stoppage have gone away.
44	Charge	Light indicator showing that the battery is being charged	This indicator is glowing continuously when the charger is in operation and has not yet reached the absorption phase. It flashes twice during the absorption phase and once during the maintenance phase. If Smart Boost mode has been activated it is possible that this indicator will go out temporarily when source backup is required by users. (See chapter 6.2.6 - p. 23)
45	AC in	Light indicator showing the presence of correct and synchronised input voltage	This indicator is glowing continuously when an alternative voltage with correct values is present at the AC IN input (13) of the device and the current limit {1107} set by the user has not been reached. It flashes when this limit is reached (see chapter 6.2.5 - p. 23).

Pos.	Denomination	Description	Comments
46	AC out	Light indicator showing the presence of a voltage at the output	This indicator is glowing continuously when an alternative voltage of 230V is present at the device output. It flashes when the device is in "load search" mode due to the absence of users. (See chapter 6.2.2 – p. 20)
47		Stop acoustic alarm	This button is not present on XTH. Note: The acoustic alarm duration {15656} is factory set at 0 sec. and is so deactivated.

16 MODEL IDENTIFICATION (FIG. 1B)

Pos.	Denomination	Description	Comments
31	Model	Model	
32	Pnom/P30	Rated power output / power for 30 minutes	
33	U Battery	Rated battery voltage (input area)	See chapter 6.2.8– p. 24
34	U ACin	Rated AC input voltage (input area)	See chapter 6.2.3 – p. 20
35	I ACin/out	Maximum current at input / output	See chapter 6.2.6 - p. 23.
36	U ACout	Rated output voltage	Or according to {1286}
37	I Charge	Maximum charger current	See chapter 6.2.4 - p. 21
38	SN:xxxxxxxxx	Serial no.	
39	IPxx	Protection degree according to IEC 60529	

17 TABLE OF STANDARD CONFIGURATIONS

No. of config.	Denomination / description	Units	Fact. value ²	Mod. value
1107	Maximum current of the AC source	A	30	
1108	Under voltage of the empty battery	V/cell	1.93	
1109	Sub-voltage of the charged battery	V/cell	1.75	
1110	Restart voltage of the inverter after under voltage of the battery	V/cell	2	
1111	Automatic startup at power up	y/n	no	
1112	Inverter frequency	Hz	50 / 60	
1121	Maximum DC voltage for stopping the Xtender	V/cell	2.84	
1126	Source assistance (Smart Boost) permitted	y/n	no	
1138	Battery charge current	A	60	
1139	Battery voltage correction according to the temperature	mV/°C/cell	-5	
1140	Battery maintenance voltage	V/cell	2.27	
1143	Voltage 1 to allow a new battery cycle	V/cell	2.1	
1144	Duration of under voltage 1 to allow a new cycle	min.	30	
1145	Voltage 2 to allow a new battery cycle	V/cell	1.93	
1146	Duration of under voltage 2 to allow a new cycle	sec.	180	
1156	Battery absorption voltage	V/cell	2.4	
1157	Duration of absorption	h	2	
1159	Current at end of absorption	Adc	10	
1161	Minimum interval between absorptions	h	3	
1187	Sensitivity of the charge detection (100% approx.25W)	%	10	
1188	Number of pulse load reserach	--	1	
1189	Time interval between load search pulses	sec.	0.8	
1190	Duration of under voltage of battery before disconnection	min.	3	
1191	Dynamic compensation for under voltage	y/n	yes	
1194	Battery adaptive low voltage allowed	o/n	no	
1195	Max voltage for adaptive low voltage	V/cell	2.08	
1198	Time elapsing before transfer relay opens	sec.	8	
1199	ACin voltage causing the opening of the transfer relay	Vac	180 / 90	
1200	Immediate open critical threshold for the transfer	Vac	100 / 50	
1246	Auxiliary contact 1 activated by voltage 1 {1247} after delays {1248}	y/n	yes	
1247	Voltage 1under which auxiliary contact 1 is activated	V/cell	1.95	
1248	Delays on voltage 1 to activate auxiliary contact 1	min.	1	
1249	Auxiliary contact 1 activated by voltage 2 {1250} after delays {1251}	y/n	yes	
1250	Voltage 2 under which auxiliary contact 1 is activated	V/cell	2	
1251	Delays on voltage 2 to activate auxiliary contact 1	min.	10	
1252	Auxiliary contact 1 activated by voltage 3 {1253} after delays {1254}	y/n	yes	
1253	Voltage 3 under which auxiliary contact 1 is activated	V/cell	2.05	
1254	Delays on voltage 3 to activate auxiliary contact 1	min.	60	
1255	Voltage 1above which auxiliary contact 1 is deactivated after delays	V/cell	2.25	
1256	Delays on voltage {1255} to deactivate auxiliary contact 1	min.	60	
1258	Auxiliary contact 1 activated by power 1	y/n	yes	
1259	Power 1 above which auxiliary contact 1 is activated	%	120	
1260	Duration of power 1 for activating auxiliary contact 1	min.	1	

² The second value concerns the 120Vac ranges

18 TECHNICAL DATA – XTH

**** concerns -01 model (120Vac range) (for all models except the XTH 8000-48)

Model	XTH 3000-12	XTH 5000-24	XTH 6000-48	XTH 8000-48
Inverter				
Rated battery voltage	12 V	24 V	48 V	48 V
Input voltage range	9.5 - 17 V	19 - 34 V	38 - 68 V	39 - 68 V
Continuous power @ 25 °C	2500 VA	4500 VA	5000 VA	7,000 VA
Smart Boost power	3000VA	5000 VA	6000 VA	8000 VA
30 minute load @ 25 °C	3000 VA	5000 VA	6000 VA	8000 VA
5 second load @ 25 °C	3 x Pcont			
Maximum load	Up to short-circuit			
Maximum asymmetrical load	Up to Pnom			
Load detection (standby)	2 to 25 W			
Admissible cos phi	0.1 – 1			
Maximum efficiency	93%	94%	96%	96%
Open-circuit power OFF/standby/ON	1.2W/2.2W/ 14W	1.3W/2.5W/ 18W	1.8W/3W/ 22W	1.8W/3.8W/ 26 W
Output voltage	Sin wave 230Vac (+/-2%) / 180-245 Vac ou ****Sin wave 120 Vac (+/-2%) / 50-140 Vac			
Output frequency	50 Hz adjustable 45-65 Hz +/- 0.05% (quartz-controlled) ****60 Hz adjustable 45-65 Hz +/- 0.05% (quartz-controlled)			
Harmonic distortion	<2%			
Overcharge and short-circuit	Automatic disconnection then 2 startup attempts			
Overheating protection	Alarm prior to disconnection and automatic restart			
Battery charger				
6-phase battery charger	Programmable I-U-Uo-equalisation-Uo(low)-U(periodic)			
Adjustable charge current	0 - 160 A	0 - 140 A	0 - 100 A	0 - 120 A
Input current limit	1 - 50 A			
Maximum input voltage	265Vac / ****150Vac			
AC input voltage range	Level detection adjustable from 150 to 230 Vac ****Level detection adjustable from 50 to 140 Vac			
Admissible input frequency (PFC)	45 - 65 Hz EN 61000-3-2			
Battery control (factory value / adjustable range with RCC-02)				
End of absorption	by duration: 2h / 0.25 - 18 h or by current < 10A / 2 - 50 A			
Absorption voltage	14.4V / 9.5-17 V	28.8V / 19-34 V	57.6V / 38 - 68 V	
Periodic absorption voltage	- / 9.5 - 17 V	- / 19 - 34 V	- / 38 - 68 V	
Floating voltage	13.6V / 9.5-18 V	27.2V / 19-34 V	54.4V / 38 - 68 V	
Reduced maintenance voltage	- / 9.5 - 17 V	- / 19 - 34 V	-- / 38 - 68 V	
Equalisation	By number of cycles (- / - 100) or at fixed intervals (- / 52 weeks)			
End of equalisation	By duration 2h / 0.25 – 10h or by current - / 5 – 50 A			
Equalisation voltage	- / 9.5 - 17 V	- / 19-34 V	- / 38 - 68 V	
Low voltage disconnection	10.8V / 9.5-17 V	21.6V / 19-34 V	43.2V / 38 - 68 V	
Reduced floating duration	- / 0 - 32 days			
Periodical absorption	- / 0 - 10 hours			
Temperature compensation	-5 / 0 to-8 mV/°C/cell (optional BTC-01)			

Model	XTH 3000-12	XTH 5000-24	XTH 6000-48	XTH 8000-48
General data				
Auxiliary contacts	2 independent contacts 16 A - 250 Vac (potential-free 3 points) ****2 independent contacts 16 A - 140 Vac (potential-free 3 points)			
Maximum transfer relay current	50 A			
Maximum transfer time	0-15 ms (UPS mode)			
Weight	34 kg	40 kg	42 kg	46 kg
Dimensions: H x W x D [mm]	230x300x500			
Protection degree	IP20			
Conformity	EN 61000-6-1, EN 61000-6-3, EN 55014, EN 55022, EN 61000-3-2, Dir. 89/336/EEC, LVD 73/23/EEC			
Operating temperature range	-20 to 55 °C			
Ventilation	Forced from 45 °C			
Noise level	<40 dB / <45 dB (without / with ventilation)			
Warranty	2 years			

Options

Remote control and programming centre for wall mounting: RCC-02

Remote control and programming centre for panel mounting: RCC-03

Battery temperature sensor: BTS-01

Communication cable for 3ph and // (CAB-RJ45-8-2)

19 TECHNICAL DATA – XTM

**** concerns -01 model (120Vac range)

XTM model	1500-12	2000-12	2400-24	3500-24	2600-48	4000-48
Inverter						
Rated battery voltage	12V		24V		48V	
Input voltage range	9.5 - 17V		19 - 34V		38 - 68V	
Continuous power @ 25 °C	1500VA	2000 VA	2000VA	3000 VA	2000VA	3500 VA
Smart Boost power	1500VA	2000 VA	2400VA	3500 VA	2600VA	4000 VA
30 minute load @ 25 °C	1500VA	2000 VA	2400VA	3500 VA	2600VA	4000 VA
5 second load @ 25 °C	3 x Pcont.					
Maximum load	Up to short-circuit					
Maximum asymmetrical load	Up to Pnom					
Load detection (standby)	2 to 25W					
Admissible cos phi	0.1 - 1					
Maximum efficiency	93%		94%		96%	
Idle power OFF/standby/ON	1.2W/ 1.4W/8W	1.2W/ 1.4W/10W	1.4W/ 1.6W/ 9W	1.4W/ 1.6W/ 12W	1.8W/2W /10W	1.8W/2.1W/ 14W
Output voltage	Sin wave 230Vac (+/-2%) / 180-245 Vac or ****Sin wave 120 Vac (+/-2%) / 50-140 Vac					
Output frequency	50 Hz adjustable 45-65 Hz +/- 0.05% (quartz-controlled) ****60 Hz adjustable 45-65 Hz +/- 0.05% (quartz-controlled)					
Harmonic distortion	<2%					
Overcharge and short-circuit	Automatic disconnection then 2 startup attempts					
Overheating protection	Alarm prior to disconnection and automatic restart					
Battery charger						
6-phase battery charger	Programmable I-U-Uo-equalisation-Uo(low)-U(periodic)					
Adjustable charge current	0 - 70A	0 - 100A	0 - 55A	0 - 90A	0 - 30A	0 - 50A
Input current limit	1 - 50A					
Maximum input voltage	265Vac / ****150Vac					
AC input voltage range	Level detection adjustable from 150 to 230 Vac ****Level detection adjustable from 50 to 140 Vac					
Admissible input frequency	45 - 65Hz					
(PFC)	EN 61000-3-2					
Battery control (factory value / adjustable range with RCC-02)						
End of absorption	by duration: 2h / 0.25 - 18 h or by current < 10A / 2 - 50 A					
Absorption voltage	14.4V /9.5-17V		28.8 / 19 - 34V		57.6 / 38 - 68V	
Periodic absorption voltage	- / 9.5 - 17V		- / 19 - 34V		- / 38 - 68V	
Floating voltage	13.6V /9.5-17V		27.2 / 19 - 34V		54.4 / 38 - 68V	
Reduced maintenance voltage	- / 9.5 - 17V		- / 19 - 34V		- / 38 - 68V	
Equalisation	By number of cycles (- / - 100) or at fixed intervals (- / 52 weeks)					
End of equalisation	By duration 2h / 0.25 - 10h or by current - / 5 - 50 A					
Equalisation voltage	- / 9.5 - 17V		- / 19 - 34V		- / 38 - 68V	
Low voltage disconnection	10.8V /9.5- 17V		21.6V /19- 34V		43.2V / 38 - 68V	
Reduced floating duration	- / 0 - 32 days					
Periodical absorption	- / 0 - 10 hours					
Temperature compensation	-5 / 0 to -8mV/°C/Cellule (option BTS-01)					

XTM model	1500-12	2000-12	2400-24	3500-24	2600-48	4000-48
General data						
Auxiliary contacts	2 independent contacts 16 A - 250 Vac (potential-free 3 points) ****2 independent contacts 16 A - 140 Vac (potential-free 3 points)					
Maximum transfer relay current	50A					
Maximum transfer time	0-15ms (UPS mode)					
Weight	15kg	18.5kg	16.2kg	21.2kg	16.2kg	22.9kg
Dimensions: H x W x D [mm]	230x300x500					
Protection degree	IP20					
Conformity	EN 61000-6-1, EN 61000-6-3, EN 55014, EN 55022, EN 61000-3-2, Dir. 89/336/EEC, LVD 73/23/EEC					
Operating temperature range	-20 to 55°C					
Ventilation	Forced from 45 °C					
Noise level	<40 dB / <45 dB (without / with ventilation)					
Warranty	2 years					

Options

Remote control and programming centre for wall mounting: RCC-02

Remote control and programming centre for panel mounting: RCC-03

Battery temperature sensor: BTS-01

Communication cable for 3ph and // (CAB-RJ45-8-2)

Remote command Modul (DIN rail mounting): RCM-10

20 NOTES



STUDER Innotec

Rue des Casernes 57

1950 Sion – Switzerland

Tél : +41(0) 27 205 60 80

Fax : +41(0) 27 205 60 88

info@studer-innotec.com

www.studer-innotec.com