

Remote control and programming unit **RCC-02** and **RCC-03** for the Xtender

User manual



Reference

This document applies to versions of firmware release R542 or higher of the remote control.
If any doubt about your software version, you can check it with the menu "Information on the system"
page 74.

Copyright © Studer Innotec SA. All rights reserved

CONTENTS

1	Foreword	5
1.1	Conventions	5
1.2	Product recycling	5
1.3	EU declaration of conformity	6
1.4	Studer Innotec contact details	6
1.5	Your reseller' contact details	6
2	Warnings and caution	7
2.1	Warranty.....	7
2.2	Limitation of responsibility	7
2.3	Safety instructions.....	7
2.4	Acceptance of the software licence and updates.....	7
2.5	Compatibility.....	8
2.6	Access code for extended functions.....	8
3	Introduction	9
3.1	Models concerned	9
3.2	Controls and indicators	9
3.3	SD card.....	9
4	Connection	10
4.1	Series connection.....	10
4.1.1	RCC-02	11
4.1.2	RCC-03	11
4.1.3	Xtender XTH	11
4.1.4	Xtender XTM	11
4.1.5	Xtender XTS.....	11
4.1.6	VarioString.....	12
4.1.7	VarioTrack.....	12
4.1.8	BSP.....	12
4.1.9	Xcom-232i.....	12
5	Dimensions	13
5.1	RCC-02	13
5.2	RCC-03	13
6	Quick Start Guide	14
6.1	Setting of the language	14
6.2	Adaptation to the source	14
6.3	Adaptation to the battery	15
6.4	Basic displays.....	16
7	Activating and deactivating the combi Xtender	17
8	Quick setting of the maximum source AC current	17
9	RCC remote control settings	18
9.1	Language {5000}.....	18
9.2	Other languages {5036}.....	18
9.3	Time {5001} and Date {5002}.....	19
9.4	User level {5012}.....	19
9.5	Force remote control to user BASIC level {5019}.....	19
9.6	Data logger {5057}.....	19
9.6.1	Data logger enabled {5101}.....	19
9.6.2	Save today's datas {5059}.....	20
9.7	Save and restore files {5013}.....	20
9.7.1	Save all files (system backup) {5041}.....	20
9.7.2	Restore all files (system recovery) {5068}.....	20
9.7.3	Apply configuration files (master file) {5070}.....	20
9.7.4	Separator of the .csv files {5032}.....	21
9.7.5	Advanced backup functions {5069}.....	21
9.8	INSTALLER– Modification of access levels of many parameters {5042}.....	22
9.8.1	INSTALLER - Change all parameters access level to: {5043}.....	22
9.8.2	INSTALLER - Restore default access level of all parameters {5044}.....	22
9.9	Backlight {5007}.....	22
9.9.1	Backlight mode {5093}.....	22

9.9.2	Backlight switch off after {5009}.....	22
9.9.3	Red backlight flashing on Xtender off and faulty {5026}.....	22
9.10	Extended and special functions {5021}.....	22
9.10.1	Display contrast {5006}	22
9.10.2	Choice of standard display {5073}.....	22
9.10.3	Come back to standard display after {5010}	23
9.10.4	Visibility of the transitory messages {5011}	23
9.10.5	Acoustic alarm active {5027}.....	23
9.10.6	Remote control acoustic alarm duration {5031}	23
9.10.7	Switching ON and OFF of system on level "VIEW ONLY" {5056}	23
10	Information on the operating mode of the installation	24
10.1	Display of the parallel and three-phase systems	26
11	Messages and account of events	27
11.1	(000) Warning: Battery low	27
11.2	(003) AC-In synchronization in progress	27
11.3	(004) Warning: Input frequency AC-In wrong.....	28
11.4	(006) Warning: Input voltage AC-In too high.....	28
11.5	(007) Warning: Input voltage AC-In too low	28
11.6	(008) Halted: Inverter overload SC.....	28
11.7	(014) Halted: Over temperature EL	28
11.8	(015) Halted: Inverter overload BL.....	29
11.9	(016) Warning: Fan error detected	29
11.10	(018) Warning: Excessive battery voltage ripple	29
11.11	(019) Halted: Battery undervoltage	29
11.12	(020) Halted: Battery overvoltage.....	29
11.13	(021) Transfer not authorized as AC-Out current is higher than Input Limit {1107}.....	29
11.14	(022) Error: Voltage presence on AC-Out	30
11.15	(023) Halted: Phase not defined	30
11.16	(024) Warning: Change the clock battery	30
11.17	(041) Error: Over temperature TR	30
11.18	(042) Halted: Unauthorized energy source at the output	30
11.19	(058) Halted: Master synchronization missing	30
11.20	(059) Halted: Inverter overload HW	30
11.21	(060) (061) Warning: Time security for auxiliary contacts.....	31
11.22	(062) Warning: Genset, no AC-In coming after AUX command.....	31
11.23	Stored events	31
12	Data logging	32
12.1	Functioning	32
12.2	Analysis and visualization of the data with the Xtender data analysis tool.....	32
13	Xtender settings	33
13.1	General	33
13.2	Configuration on a system with several Xtenders	33
13.3	Utilisation and access levels.....	33
13.4	Pre-defined functions of the auxiliary relays	33
13.5	Access to the parameters	34
13.5.1	Access to a parameter by its number.....	34
13.5.2	Access to a parameter via the menu	34
13.6	INSTALLER - Utilisation and access levels.....	35
13.7	Basic settings {1100}	35
13.7.1	Basic parameters set by means of the potentiometer in the XTS {1551}.....	35
13.7.2	Maximum current of AC source (Input limit) {1107}.....	36
13.7.3	Battery charge current {1138}.....	36
13.7.4	Smart-Boost allowed {1126}.....	37
13.7.5	Inverter allowed {1124}.....	37
13.7.6	Type of detection of the grid loss (AC-In) {1552}.....	37
13.7.7	Standby level {1187}	38
13.7.8	Restore default settings {1395}.....	38
13.7.9	INSTALLER - Restore factory settings {1287}.....	38
13.8	Battery management and cycle {1137}.....	39
13.8.1	Charger allowed {1125}.....	42
13.8.2	INSTALLER - Charger uses only power from AC-Out {1646}	42

13.8.3	Battery charge current {1138}.....	42
13.8.4	Temperature compensation {1139}.....	42
13.8.5	Undervoltage {1568}.....	43
13.8.6	Battery overvoltage level {1121}.....	44
13.8.7	Restart voltage level after an battery overvoltage {1122}.....	44
13.8.8	Floating voltage {1140}.....	44
13.8.9	Force phase of floating {1467}.....	44
13.8.10	New cycle menu {1141}.....	44
13.8.11	INSTALLER - Use dynamic compensation of battery level (new cycle) {1608}.....	45
13.8.12	Absorption phase {1451}.....	46
13.8.13	Equalization phase {1452}.....	47
13.8.14	Reduced floating phase {1453}.....	49
13.8.15	Periodic absorption phase {1454}.....	50
13.9	Inverter {1186}.....	50
13.9.1	Inverter allowed {1124}.....	50
13.9.2	AC-Output voltage {1286}.....	50
13.9.3	AC voltage increase according to battery voltage {1548}.....	51
13.9.4	Max AC voltage increase with battery voltage {1560}.....	51
13.9.5	Inverter frequency {1112}.....	51
13.9.6	Inverter frequency increase when battery full {1536}.....	52
13.9.7	Inverter frequency increase according to battery voltage {1549}.....	52
13.9.8	Max frequency increase {1546}.....	53
13.9.9	Speed of voltage or frequency change in function of battery {1534}.....	53
13.9.10	Standby and turn on {1420}.....	53
13.9.11	Solsafe presence, Energy source at AC-Out side {1438}.....	54
13.10	AC-In and transfer {1197}.....	54
13.10.1	Transfer relay allowed {1128}.....	54
13.10.2	Delay before closing transfer relay {1580}.....	54
13.10.3	Smart-Boost allowed {1126}.....	54
13.10.4	INSTALLER - Limitation of the power Boost {1607}.....	55
13.10.5	Maximum current of AC source (Input limit) {1107}.....	55
13.10.6	Max input current modification {1471}.....	55
13.10.7	Overrun AC source current limit without opening the transfer relay (Input limit) {1436}.....	56
13.10.8	Type of detection of the grid loss (AC-In) {1552}.....	57
13.10.9	Tolerance on detection of AC-input loss (tolerant UPS mode) {1510}.....	57
13.10.10	Input voltage giving an opening of the transfer relay with delay {1199}.....	57
13.10.11	Time delay before opening of transfer relay {1198}.....	57
13.10.12	Input voltage giving an immediate opening of the transfer relay (UPS) {1200}.....	57
13.10.13	INSTALLER – Absolute max limit for input voltage {1432}.....	57
13.10.14	Delta frequency allowed above the standard input frequency {1505}.....	58
13.10.15	Delta frequency allowed under the standard input frequency {1506}.....	58
13.10.16	Duration with frequency error before opening the transfer {1507}.....	58
13.10.17	AC-In current active filtering {1575}.....	58
13.10.18	INSTALLER - Use an energy quota on AC-input {1557}.....	58
13.10.19	INSTALLER - AC-In energy quota {1559}.....	58
13.11	Auxiliary contacts 1 and 2 {1201} {1310}.....	58
13.11.1	Operating mode {1202} {1311}.....	59
13.11.2	Combination of the events for the auxiliary contact {1497} {1498}.....	60
13.11.3	Temporal restrictions {1203} {1312}.....	60
13.11.4	Contact active with a fixed time schedule {1269} {1378}.....	60
13.11.5	Contact active on event {1455} {1456}.....	61
13.11.6	Contact active according to battery voltage {1245} {1353}.....	62
13.11.7	Contact active with inverter power or Smart-Boost {1257} {1366}.....	63
13.11.8	INSTALLER - Contact active according to battery temperature {1503} {1504}.....	63
13.11.9	Contact active according to SOC {1501} {1502} (only with BSP).....	64
13.11.10	Security, maximum time of contact {1512} {1513}.....	64
13.11.11	Maximum time of operation of contact {1514} {1515}.....	64
13.11.12	Reset all settings {1569} {1570}.....	64
13.12	Auxiliary contacts 1 and 2 extended functions {1489}.....	65
13.12.1	Generator startup.....	65
13.12.2	Generator control active {1491}.....	65



13.12.3	Number of starting attempts {1493}.....	65
13.12.4	Starter pulse duration (with AUX2) {1492}	65
13.12.5	Time before a starter pulse {1494}	65
13.12.6	Main contact hold/interrupt time {1574}	65
13.13	System {1101}.....	66
13.13.1	Remote entry (Remote ON/OFF) {1537}.....	66
13.13.2	Batteries priority as energy source {1296}	67
13.13.3	Battery priority voltage {1297}.....	67
13.13.4	Buzzer alarm duration {1565}.....	67
13.13.5	Auto restarts {1129}.....	68
13.13.6	System earthing (Earth - Neutral) {1484}	69
13.13.7	INSTALLER – Watchdog control system {1628} and {1629}	69
13.13.8	INSTALLER – Parameters saved in flash memory {1550}.....	69
13.13.9	Reset of all the inverters {1468}	69
13.14	Multi Xtender system {1282}.....	70
13.14.1	Integral mode {1283}	70
13.14.2	Multi inverters allowed {1461}.....	70
13.14.3	Multi inverters independents. Need reset {1468} {1462}.....	70
13.14.4	Battery cycle synchronized by the master {1555}.....	70
13.14.5	Allow slaves standby in multi-Xtender system {1547}.....	70
13.14.6	Splitphase: L2 with 180 degrees phaseshift {1571}	70
13.14.7	INSTALLER – Minigrid compatible {1437}.....	70
13.14.8	INSTALLER – Minigrid with shared battery energy {1577}.....	71
13.15	Grid-feeding {1522}.....	71
13.15.1	Grid feeding allowed {1127}	71
13.15.2	Maximum grid feeding current {1523}.....	71
13.15.3	Forced grid feeding {1524} {1525} {1526}.....	72
13.15.4	INSTALLER - Use of the defined phase shift curve for injection {1610}	72
13.15.5	INSTALLER - Cos phi at P=0% {1622}.....	73
13.15.6	INSTALLER - Power of the second cos phi point in % of Pnom {1613}	73
13.15.7	INSTALLER - Cos phi at the power defined by param {1613}, {1623}	73
13.15.8	INSTALLER - Cos phi at P=100% {1624}.....	73
13.15.9	INSTALLER - ARN4105 frequency control enabled {1627}	73
13.15.10	INSTALLER - Delta from user frequency to start derating {1630}	73
13.15.11	INSTALLER - Delta from user frequency to reach 100% derating {1631}	73
14	Information on the system	74
14.1	Remote controls	74
14.2	Xtender.....	74
15	Software updates.....	74
15.1	Updating process	74
16	Application examples	75
16.1	General use: Inverter, Charger with grid	75
16.2	Use of a limited power source	75
16.3	Use to increase the power on an existing installation	76
16.4	Load shedding of the second priority loads	76
17	Appendices.....	77
17.1	Appendix 1: List of configuration interdependencies	77
17.2	Trouble-shooting	78
18	Parameter tables	82
18.1	Remote control parameters.....	82
18.2	Inverter parameters	84
19	Parameter index {xxxx}	97

1 FOREWORD

This manual contains information relating to the functioning of the RCC-02 and RCC-03 remote controls.

The use of certain functions sometimes requires advanced knowledge in various fields. This manual cannot provide this. In case of doubt, please contact your reseller or installer.

1.1 CONVENTIONS

	This symbol is used to indicate the presence of a dangerous voltage that is sufficient to constitute a risk of electric shock.
	This symbol is used to indicate a risk of material damage.
	This symbol is used to indicate information that is important or which serves to optimize your system.

Terminology:

The following terms are used in the manual to provide greater clarity:

RCC is used to indicate the remote control RCC-02 or RCC-03 if the description applies to both models.

Installation is used to describe all the electrical equipment connected together. This may be the source (public grid or generator), and one or more Xtender(s) with or without remote control as well as electrical consumers.

System is used to describe the entirety of Xtenders with or without remote control.

Xtender or **combi** is used to describe one or more Xtender(s) connected together.

1.2 PRODUCT RECYCLING

The RCC remote control conforms to the European directive 2011/65/EU on hazardous substances and does not contain the following elements: lead, cadmium, mercury, hexavalent chrome, PBB or PBDE.



To dispose of this product, please use the service for the collection of electrical waste and observe all applicable obligations according to the place of purchase.

1.3 EU DECLARATION OF CONFORMITY

The remote control, RCC-02/-03, described in this manual meets the requirements specified in the following EC directives and norms:

Low Voltage Directive (LVD) 2014/35/EU

- EN 62368-1:2014

Electromagnetic Compliance (EMC) Directive 2014/30/EU

- EN 61000-6-2:2005

- EN 61000-6-4:2007/A1:2011

CH – 1950 Sion, April 2017

Studer Innotec (R. Studer)



1.4 STUDER INNOTEK CONTACT DETAILS

Studer Innotec SA
Rue des Casernes 57
CH – 1950 Sion

Tel.: +41 (0)27 205 60 80

Fax.: +41 (0)27 205 60 88

Customer service: info@studer-innotec.com

Sales office: sales@studer-innotec.com

Technical support: support@studer-innotec.com

Website: www.studer-innotec.com

1.5 YOUR RESELLER' CONTACT DETAILS

2 WARNINGS AND CAUTION

2.1 WARRANTY

Studer Innotec warrants its full range of inverters to be free from defects in workmanship and materials for a period of **5 years** from the date of manufacture.

Any warranty claim will be refused if it is not sent back to the point of sale, or another place indicated by Studer Innotec, in appropriate packaging and accompanied by a copy of the dated proof of purchase.

No warranty claims will be accepted for damage resulting from handling, usage or processing that does not explicitly appear in this manual.

Cases of damage arising from the following causes are notably excluded from the warranty:

- Inappropriate use
- The presence of liquids in the device or oxidation resulting from condensation
- Damage resulting from falls or mechanical shocks
- The opening or alteration of the RCC remote control, carried out without the explicit authorization of Studer Innotec
- Damage due to atmospheric surge voltage (lightning)
- Damage from transportation due to inappropriate packaging

2.2 LIMITATION OF RESPONSIBILITY

The placement, commissioning, use, maintenance and servicing of the RCC remote control cannot be the subject of monitoring by Studer Innotec. For this reasons Studer Innotec assumes no responsibility and liability for damage, costs or losses resulting from an installation that does not conform to the instructions, from a defective functioning or from a deficient maintenance.

The use of Studer Innotec devices is the responsibility of the customer in all cases. This equipment is neither designed nor guaranteed to supply installations used for vital medical care nor any other critical installation carrying significant potential damage risks to people or the environment.

Studer Innotec does not assume any responsibility for the infringement of patent rights or other rights of third parties that result from using the devices.

The responsibility of Studer Innotec may not under any circumstances exceed the amount spent to purchase the product.

Studer Innotec reserves the right to make any modifications to the product without prior notification.

2.3 SAFETY INSTRUCTIONS

Carefully read the following safety instructions in order to avoid any injury or risk of damaging this product and those that are connected to it.

Only use the connection cable specified and supplied by Studer Innotec. Under no circumstances should you use a damaged cable. In case of doubt about the condition of this device, it should be inspected by a qualified technician.

Do not use the RCC remote control in a humid environment.

Do not use the RCC remote control in an explosive environment.

2.4 ACCEPTANCE OF THE SOFTWARE LICENCE AND UPDATES

By using the RCC remote control, you are accepting the terms and conditions of the following licence agreement. Please read this carefully.

Studer Innotec is granting a limited licence to use the software installed in this equipment in its executable binary format during the normal functioning of the product. The title, the property rights and the copyrights relating to this software, remain the property of Studer Innotec.

You acknowledge that the software is the property of Studer Innotec and that it is protected by copyright law according to the international copyright treaties.

You also acknowledge that the structure, organisation and software code are valuable commercial secrets belonging to Studer Innotec. You agree not to decompile, disassemble, alter or reverse either the unit or the engineering or make the software readable, irrespective of which part of the software, or to create any work whatever that is based on this software.

Updating must be done in the full awareness of the cause and is always the responsibility of the customer. Partial updates may cause ruptures in the compatibility or in its stochastic operation.

2.5 COMPATIBILITY

Studer Innotec guarantees the compatibility of the software updates with the hardware for one year, starting from the date of purchase. The updates are no longer guaranteed beyond this date and a hardware upgrade may be required. Please contact your reseller for any additional information on compatibility.

2.6 ACCESS CODE FOR EXTENDED FUNCTIONS

In order to use the RCC-02, RCC-03 remote control in extended mode, you must have installer or QSP (Qualified Service Partner) level authorisation from Studer Innotec. After your accreditation you will receive a code number which will allow you to access these functions. This code number is exclusively valid for devices manufactured during the current year or older; the most recent code may therefore be used for all operations.

Fill in the code you have received below in order to take advantage of the extended functions of the RCC-02, RCC-03 remote control.

Year	Code
2011-	

The additional functions available with a professional user level appear in gray in this manual. Depending on your access code, you may not have access to all the functions described in this manual. Certain functions are reserved for servicing or factory testing. Please ask your supplier for more details on this subject.

3 INTRODUCTION

Congratulations! The purchase of an RCC remote control offers you unlimited access to the various functions of the devices in the Xtender series. Numerous configurations that can now be accessed allow you to optimize the operation of the installation. Despite all these options, the Xtender works on a simple basis.

Different figure scenarios as well as associated configurations are presented at the end of this manual. The manual for the RCC remote control is divided into several distinct parts:

The first part (page 10 to 23) is dedicated to the adjustments of the RCC remote control, whether this is the language used or the clock, which are sometimes necessary for the whole installation to work well.

The second part (page 24 to 31) is concerned with immediate information on the installation. This gives access to the electric values such as the battery voltage, inverter load and many more.

The third part (page 32 to 32) shows the functions for saving events occurring in the installation. This may be necessary for diagnosing a weakness or simply to check that the whole unit is working well during its whole service life.

The fourth part (page 33 to 72), which is more technical, presents various options for configuring the Xtender.

Do not change the configurations except when you have the technical knowledge; otherwise, the operation of the installation could at risk or installation itself could be partly damaged.

The fifth part (page 74 to 76) consists of more general items like information about the system, the updating process or examples of applications.

The sixth part (page 82 to 96) consists of two tables with all "Remote control" and "Inverter" parameters. These tables, which follow the same hierarchical order as in the remote control, give an overview on all adjustable parameters and also information about the factory settings.

3.1 MODELS CONCERNED

The RCC remote control may be connected to any Xtender, VarioTrack or VarioString the use of which is clearly detailed in its operating instructions.

3.2 CONTROLS AND INDICATORS

The RCC remote control is equipped with four operating keys as well as a graphic display with back-lighting. The function of the keys may change according to the context of utilisation and a reminder of the function in progress is given at the right of the display.

Generally the keys UP and DOWN are used to alter values or options relating to what is on the display and the two central keys are used to access, confirm or quit the item shown.

If the back-lighting function is activated, pressing one of the keys starts it up.



3.3 SD CARD

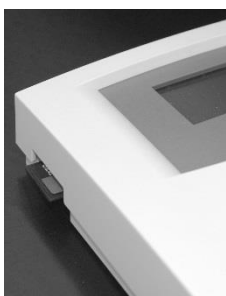

RCC-02

The RCC remote control is equipped with an SD (Secure Digital)-type memory card reader. This card (supplied) is used for various functions described in this manual. It allows, amongst others, the following functions: recording statistics, updates, backups or restoration of configurations or adjustments. The filing system used for the data is the FAT system (FAT16). This card can be read using any standard SD card reader.

As far as the RCC-03 is concerned, the use of the SD card requires removing the remote control since the access to the SD lies behind.



RCC-03

	<p>The system of the card reading is compatible with the following types of cards: SD and SD HC The system of the card reading is incompatible with the following types of cards: SD XC and cards of more than 32 GB</p>
--	--

4 CONNECTION

The RCC-02 remote control must be firmly fastened using 3 screws on a flat support. The remote control RCC-03 is meant to be integrated. It must be mounted by means of 4 screws (not supplied) on a flat surface without any mechanical constraints to the front plate. Once the RCC remote control is fastened it can be connected to the inverter using the authorized cable only. If the cable is damaged or if a socket is detached, the cable must not be connected since this can lead the whole installation to malfunction.

A maximum of 3 remote controls can be connected to one unit. The XTS inverter/charger can only be connected to one accessory.

4.1 SERIES CONNECTION

Devices in the Xtender series are equipped with a proprietary communication bus for data exchange, configuration and updating of the system. Series connection is obtained by linking the devices with the provided communication cables. This way a serial bus is created where the terminations must be activated on the units on both ends.

Each device is equipped with a switch offering to choose between open "O" and terminated "T". By default, all terminations are activated on each Studer Innotec product. The devices at the end of the line must be set on "T" (one cable) and all the others on "O" (two cables).



A wrong setting of the terminations can lead to an erratic running of the installation or impede its updating.



The remote control must never be placed in between two devices connected to the battery (Xtender, VarioTrack, VarioString).

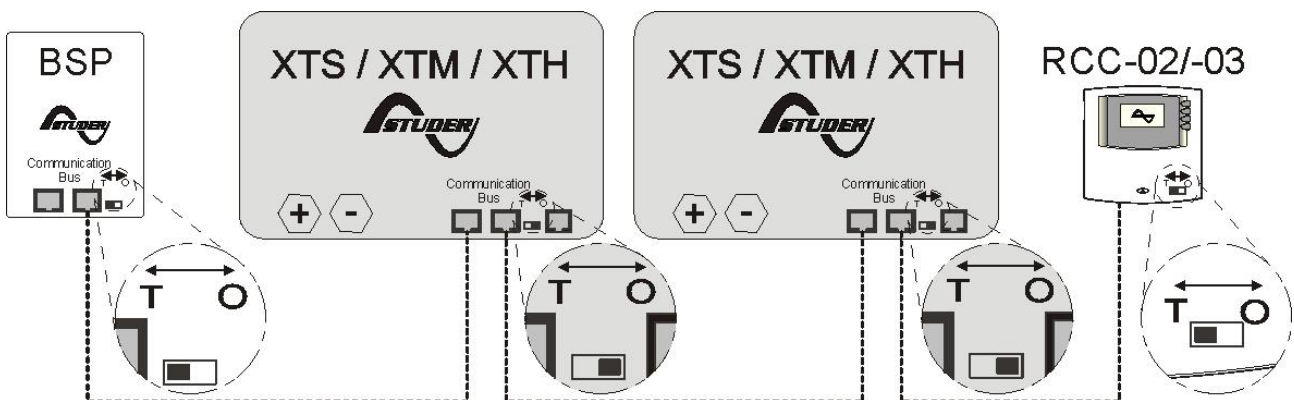

Exemple of an installation with indicated terminations.

4.1.1 RCC-02

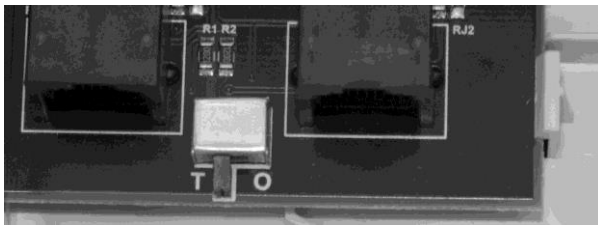

RCC-02 termination activated (position T)

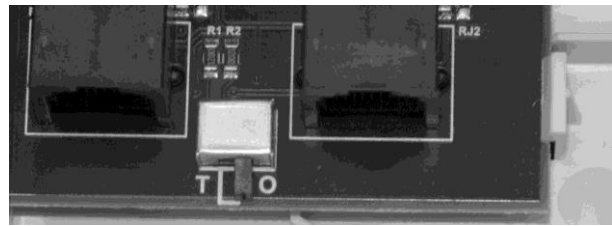

RCC-02 termination deactivated (position O)

4.1.2 RCC-03

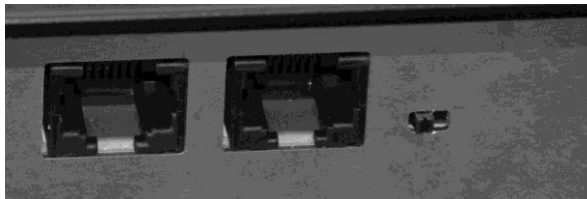

RCC-03 termination activated
(left position)

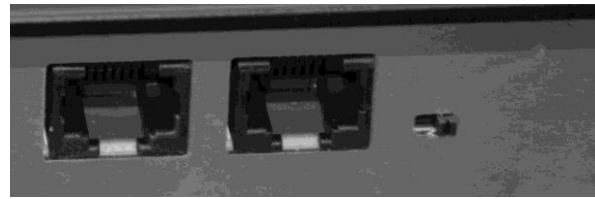

RCC-03 termination deactivated
(right position)

4.1.3 Xtender XTH

To activate the termination on the Xtender, move the two mini-switches to position T, and to deactivate it, move them downwards to position O.

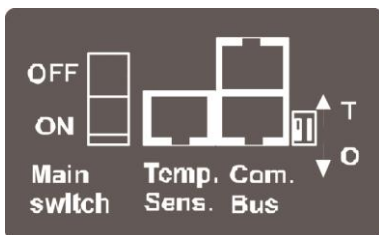

4.1.4 Xtender XTM

On an Xtender type XTM, to activate the termination, put the mini-switch on position T, to deactivate it, move it to the right on position O.

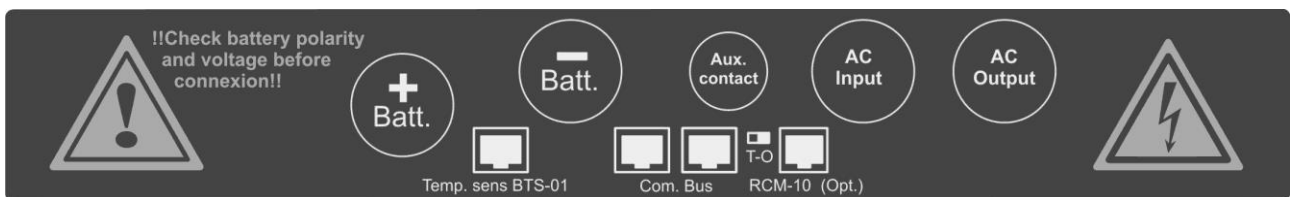

4.1.5 Xtender XTS

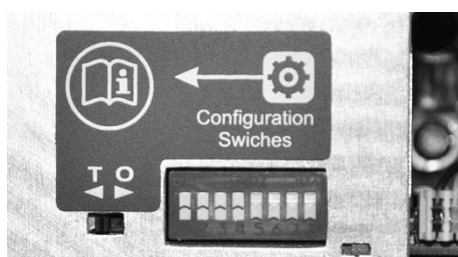

XTS termination activated (position T)

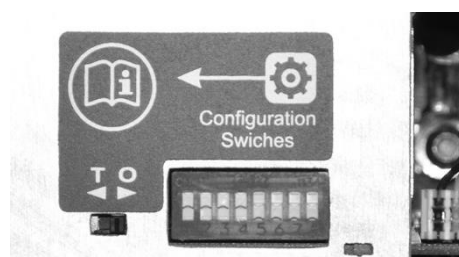

XTS termination deactivated (position O)

4.1.6 VarioString

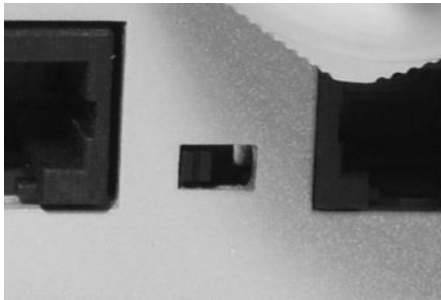

VarioString termination activated (left position)

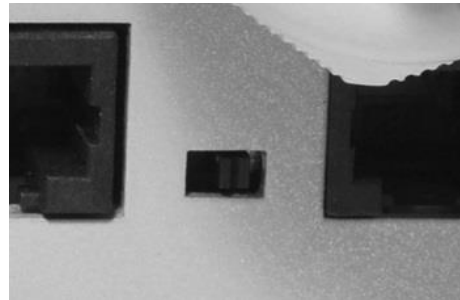

VarioString termination deactivated (right position)

4.1.7 VarioTrack

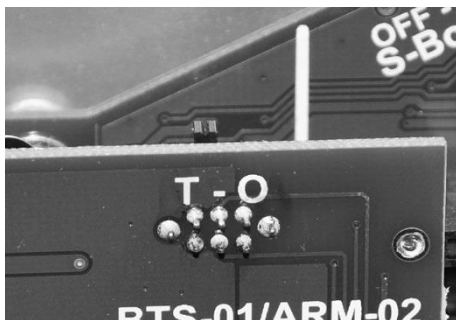

VarioTrack termination activated (position T)

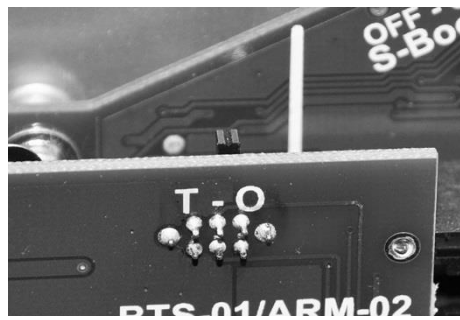

VarioTrack termination deactivated (position O)

4.1.8 BSP

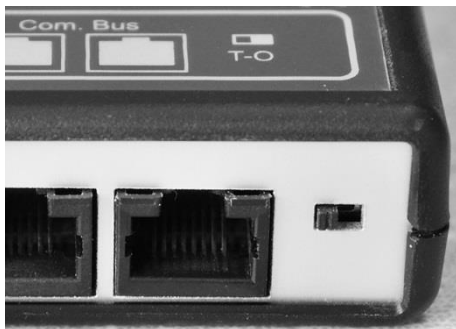

BSP termination activated (position T)

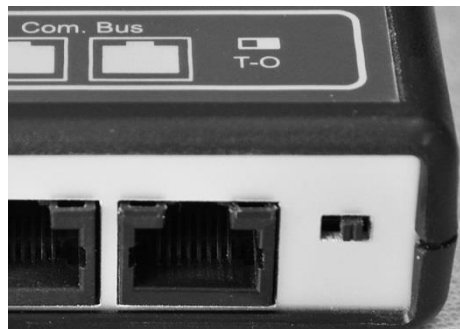

BSP termination deactivated (position O)

4.1.9 Xcom-232i

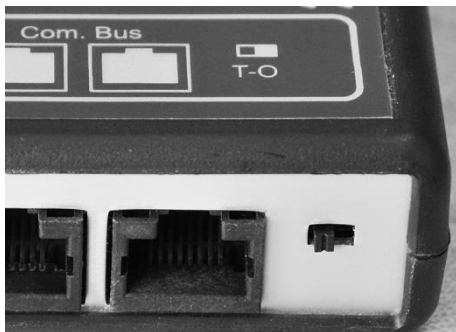

Xcom-232i termination activated (position T)

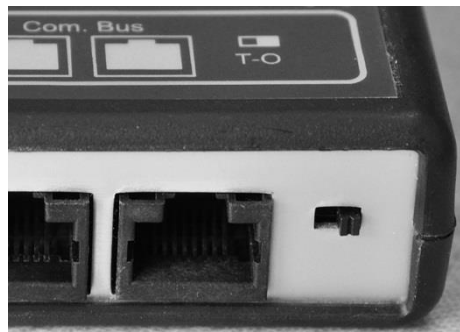

Xcom-232i termination deactivated (position O)

5 DIMENSIONS

5.1 RCC-02

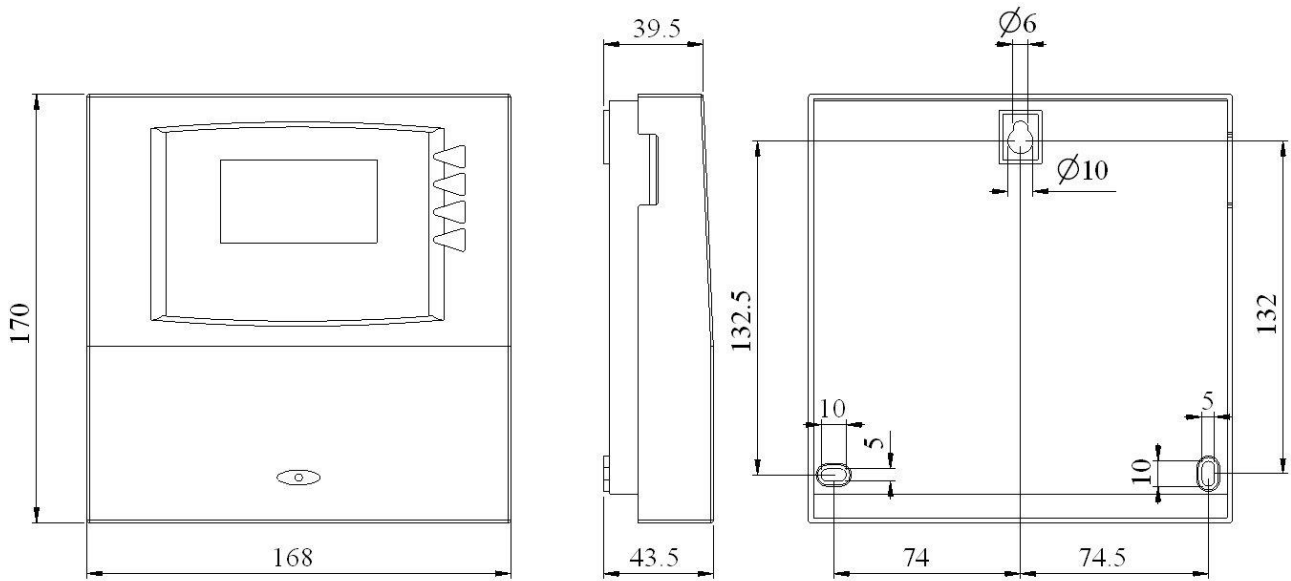

5.2 RCC-03

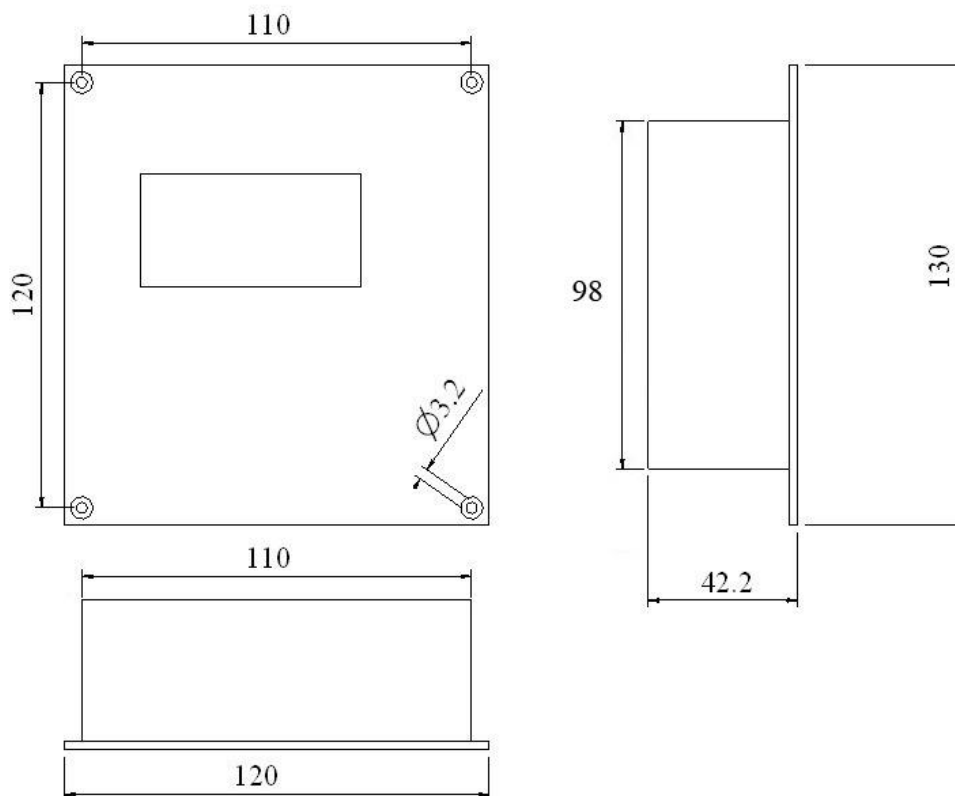

6 QUICK START GUIDE

The remote control RCC gives you access to a many settings possibilities. However, in most cases the setting of two parameters only is required for the perfect running of your installation.

6.1 SETTING OF THE LANGUAGE

To begin, set your remote control RCC for a display of the information in English.

The basic display is:

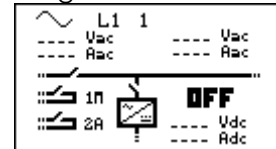

Press 1 time on the key "arrow downwards" to display the following screen:

Once beyond this screen you can come back to it by means of the key "arrow upwards".

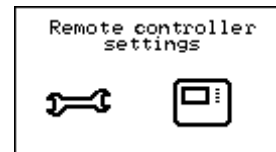

Press the key SET to enter the remote control settings. The screen of the language choice appears.

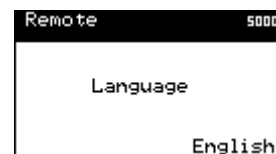

Press once more the key SET to modify the current language. The language then appears in reverse video.



With the keys "arrow upwards" and "arrow downwards" choose the language you wish. Then validate your choice by means of the key SET (OK).

We can now leave the setting of the remote control with the key ESC.

6.2 ADAPTATION TO THE SOURCE

It is a matter of indicating to the Xtender the power available to charge the batteries and to supply the users. In order to adapt your installation to the source it is connected to, proceed as follows:

The basic display is:

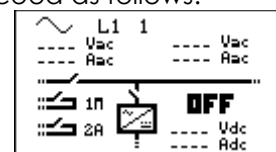

Press 2 times on the key "arrow downwards" to display the following screen:

Once beyond this screen you can come back to it by means of the key "arrow upwards".

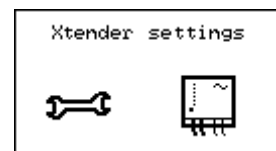

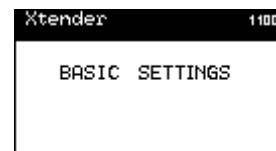

Press the key SET to access to the settings. Then again on the key SET to access to the basic parameters.

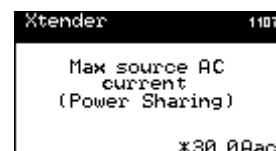

You can now adapt your installation to the source which it is connected to.

Max. current of the AC source (Input limit) {1107}.



	<p>In case of using the Xtender on a public grid, it is actually the value of the circuit breaker on the source side (fuse or breaker). In a building, this value lies generally between 8 and 16A. In the case of a shorepower or of a camping terminal, it lies between 2 and 6A.</p> <p>In case of using the Xtender on a genset, you can divide the genset power by the operating voltage (for instance for a genset of 3500VA, or 3500W, and 230V you get $3500/230=15.2$). Caution: the powers given on the gensets are often overestimated compared to their real performances. To obtain a useable value it is necessary to multiply this result by 0.6 or 0.7 (in that case $15.2*0.7=10.64$).</p>
---	---

Press the key SET to modify the value of this parameter (it appears in reverse video). By means of the keys "arrow upwards" and "arrow downwards" change the value to adapt it to your source and validate your setting with the key SET (OK).

6.3 ADAPTATION TO THE BATTERY

Charge current {1138}

In order that your Xtender manages the best possible the energy stored in your batteries and that it charges them optimally, it is necessary to indicate the current which they can be charged with. You will find this value in the technical data provided by your batteries manufacturer.

	<p>In a system with several Xtenders, this value represents the current of each Xtender. It is therefore necessary to divide the current required by your battery by the number of Xtenders.</p>
--	--

	<p>In the case of lead-acid batteries, one generally uses one tenth or one fifth of the battery capacity value. For instance for a 500Ah battery: $500/10=50A$ to $500/5=100A$.</p>
---	---

The basic display is:

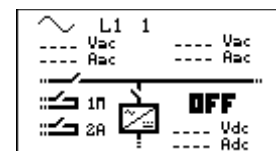

Press 2 times on the key "arrow downwards" to display the following screen:

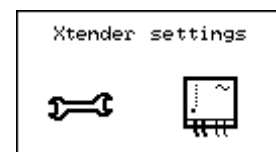

Once beyond this screen you can come back to it by means of the key "arrow upwards".

Press the key SET to access to the settings.

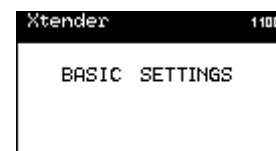

Then again on the key SET to access to the basic parameters. With the key "arrow downwards", access the menu "Battery and charger cycle".

You are now going to set the charge current for the batteries:

Press the key SET to modify the value of this parameter (it appears in reverse video). With the keys "arrow upwards" and "arrow downwards" change the value to adapt your battery and validate your setting with the key SET (OK).

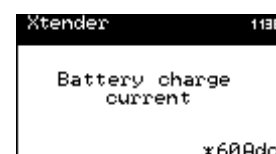

6.4 BASIC DISPLAYS

When the remote control is connected to an Xtender, it is possible to access to different display menus divided into distinct categories.

Information on the system



The history of events occurring in the installation



Real time information displays on the operating mode of the installation

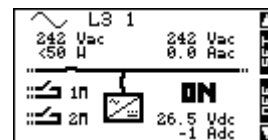

The different measures carried out by the BSP
 (Only if a BSP is present)

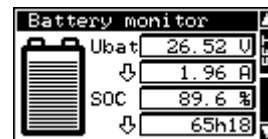

The different measures carried out by the VarioTrack
 (Only if a VarioTrack MPPT is present)

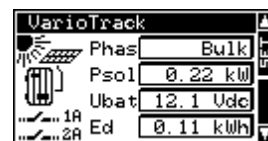

The different measures carried out by the VarioString
 (Only if a VarioString MPPT is present)

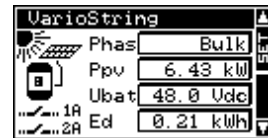

Adjustment of RCC remote control options



Adjustment of configurations on the Xtender(s)

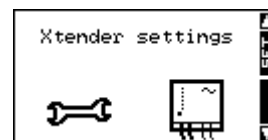

The settings of the BSP
 (Only if a BSP is present)

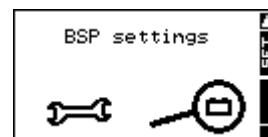

The settings of the VarioTrack
 (Only if a VarioTrack MPPT is present)

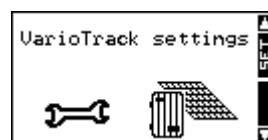

Information

Settings

The settings of the VarioString
(Only if a VarioString MPPT is present)



To go from one display to the other, use the keys UP and DOWN on the RCC remote control. To visualize or modify the options of one of the basic displays, press the key SET when this one is displayed.

i Depending on the components connected to your system, it is possible that other displays complete this serie.

In the case of a system in 3-phase or in parallel, the following displays are available too:

Real time display of information on the state of running of the installation

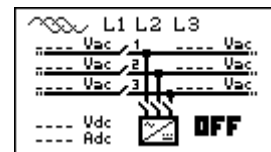
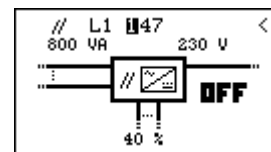

7 ACTIVATING AND DEACTIVATING THE COMBI XTENDER

When one of the displays is visible, it is possible to activate or deactivate the Xtender. To do this, simply press the key ESC. The key request on the screen indicates whether you are going to activate or deactivate the unit.

Once the key has been pressed, you must confirm your choice by using the key YES. If you do not want the action to be carried out, it can be cancelled by pressing the NO key.

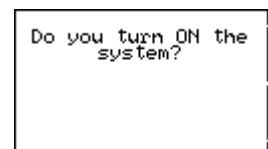

i Note: This is a comprehensive signal and leads to the stoppage or starting of all Xtenders connected to the remote control.

i The Xtender can also be turned ON or OFF directly on the Xtender with the button:



8 QUICK SETTING OF THE MAXIMUM SOURCE AC CURRENT

It is possible to access directly to the setting of the AC source maximum current (Input limit) {1107} with the key SET (FAST) from the simplified display (clock).

i For the users travelling, the available source often differs in power. This quick access menu allows to easily set the maximum current available.

9 RCC REMOTE CONTROL SETTINGS

This screen gives you access to the remote control basic settings. From one of the basic menu items, use the keys UP and DOWN until reaching the item "Adjustment of the remote control", then confirm by using the key SET.

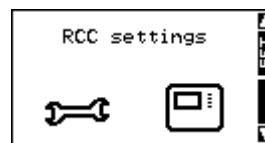

When the item to be modified appears on the screen, press the key SET to be able to modify it. This value then displays in inverse video. Now use the keys UP and DOWN to modify it. Once the correct value has been obtained, confirm by using the SET key or exit without modifying by using the key ESC.



Each configuration has a unique ID displayed top right (see example below) these numbers are indicated between curly brackets in this manual : {xxxx}

EXAMPLE to modify the current date
Go to the following screen using the UP and DOWN keys.
Press the key SET to access the remote control adjustment.

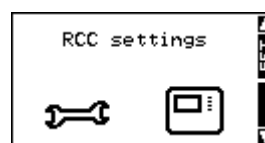

Go to the following screen using the key DOWN.
Press the key SET to modify the configuration



Set the correct date using the keys UP and DOWN
Go to the adjustment of the month using the key SET
Also set the month using the keys UP and DOWN
To complete, go to the year adjustment using the key SET
After having adjusted the year using the keys UP and DOWN, confirm using the key SET.



9.1 LANGUAGE {5000}

The default language is English and the Xtender can store up to four languages simultaneously. This configuration allows you to choose one of them.

9.2 OTHER LANGUAGES {5036}

The default available languages in the remote control are: English, French, German and Spanish. It is possible to change the languages memorized in the remote control. For this you must use a SD card with the latest update available on our website (www.studer-innotec.com/en/downloads/). Ask your reseller to know what languages are available.

The first language available (English) can not be modified.

- To change a language, follow this process:
- Make sure you have a SD card with the file for the language you wish to use
- Insert the SD card and wait for an possible automatical update of the remote control
- Enter the menu "other languages" {5036}
- Choose the language you wish to replace (second, third or fourth {5038} {5039} {5040}) and select the new language
- The updating is done automatically

9.3 TIME {5001} AND DATE {5002}

The Xtender has a perpetual calendar and an internal clock powered by a backup battery. The correct adjustment of the date and time allows accurate recording of events occurring in the installation as well as correct use of time-related functions, e.g. the disabling of the auxiliary relays during the night.

9.4 USER LEVEL {5012}

The setting of the user level allows you to choose the access to the Xtender according to your level of expertise.

The **INFO ONLY** level may be selected by entering the code:

460081

This level does not allow the Xtender configurations to be modified; it only allows information to be displayed on the system.

	Use the INFO ONLY level after adjusting the configurations if the remote control is located in a public place or if it is accessible by people who are not authorized to carry out adjustments on your system. You may change the level at any time to make new adjustments, by entering the appropriate code.
---	---

The **BASIC** level allows you to configure basic Xtender functions, limiting the field of actions to simple configurations. Please note that the incorrect adjustment of basic configurations may lead to the malfunctioning of the installation. This level is selected by default. To return to this level after a change, enter code:

943274

The **EXPERT** level allows access to more complex Xtender configurations and this level of usage may only be used with extensive specialist knowledge. To access the expert level, enter code:

426468

	In Expert mode, it is possible to change the battery voltage values. In order to comply with standard EN/IEC62109-1, an installation should not have a battery voltage above 60Vdc.
---	---

9.5 FORCE REMOTE CONTROL TO USER BASIC LEVEL {5019}

You can with this option bring the remote control back to the level "user Basic".

	Use this function at the end of the system setting to go out of the EXPERT mode.
---	--

9.6 DATA LOGGER {5057}

9.6.1 Data logger enabled {5101}

Activates the data logger. There are three possible values: Automatic /Yes /No. In automatic mode the data logger is activated on all RCC, Xcom-LAN and Xcom-GSM.

Every day at midnight a CSV file is created on the SD card in the directory CSVFILES, in the subfile LOG. This file contains the recordings minute by minute of the main system electrical values. This file can reach the size of 1MB. Make sure that there is enough available space on the SD card. If there

is not enough space while creating the CSV file the datalogger will automatically delete the 30 oldest log files from the SD card.

 The remote control RCC supports FAT or FAT32 formatted SD cards of the following types: SD/Micro SD and SD HC/Micro SD HC. It is not compatible with SD XC/Micro SD XC cards or cards with a capacity higher than 32 GB.

 In case of software updating of the system, the data of the day are lost.

 You will find more information and the easiest method to exploit these data in the chapter "Data logger", p. 32 of this document.

9.6.2 Save today's datas {5059}

If you want to have the data of the current day, you can force the recording of the data of the day with this function. The file then created will only be partial and a new file with all data will be generated at midnight.

9.7 SAVE AND RESTORE FILES {5013}

The different options of this menu allow you to do a safety backup of your system or various actions in relation to the SD card.

 The remote control RCC supports FAT or FAT32 formatted SD cards of the following types: SD/Micro SD and SD HC/Micro SD HC. It is not compatible with SD XC/Micro SD XC cards or cards with a capacity higher than 32 GB.

9.7.1 Save all files (system backup) {5041}

This function enables to save in one operation all files linked to the remote control:

- The events history files
- The remote control parameter files
- The Xtender parameter files
- The VarioTrack parameter files
- The VarioString parameter files
- The BSP parameter files

 Caution: when using this function with a 9 Xtender system, the process of copying files can last up to 15 minutes.

9.7.2 Restore all files (system recovery) {5068}

This parameter restores all Xtenders, BSPs and remote controls settings saved with the parameter "Backup of all files {5041}".

9.7.3 Apply configuration files (master file) {5070}

If your installer brings a configuration file for your system, you can implement it using this menu. Insert the SD card with the configuration files and start uploading them by pushing the button SET. Be aware that this operation can last several minutes. Depending on the contents of the configuration files, all devices in the system can be configured. During the configuration, it is normal that some devices are automatically activated.

9.7.4 Separator of the .csv files {5032}

With this option you can choose the field separator for the csv file. The separator must be adapted to the operating system and the language used in order to be correctly interpreted. You can choose in between the "automatic" mode (which will select automatically the separator according to the language set on the RCC-02/-03), a comma (,) or a semicolon (;). For systems in French/German/Italian it is the semicolon (;) that is normally used, while for systems in English/Chinese, it is the comma (,).

9.7.5 Advanced backup functions {5069}



According to the configuration of your system additional functions may be available in this menu.

9.7.5.1 Save messages {5030}

This parameter allows saving the message files (Event history) on the SD card. The data are written in a CSV format file that can be read by almost all spreadsheets and word processing softwares. The file is written in a directory called STATS and in a subdirectory which shows the backup date.

9.7.5.2 Save and restore RCC files {5049}

This menu contains commands exclusively related to the RCC remote control.

9.7.5.3 Save and restore Xtender files {5050}

This menu contains commands exclusively related to the connected Xtender inverter/chargers.

9.7.5.3.1 Save Xtender parameters {5017}

This function writes the operational configurations on to the SD card of the Xtender. You can use this function to do a backup of the remote control parameters or to visualize on a computer the values that you have selected.

The file in CSV format is written in a directory called CSVFILES\FID\DATE.

The directory FID indicates the unique identification of your Xtender and contains the subdirectory which indicates the date of backup.

9.7.5.3.2 Load Xtender parameters {5018}

Reload the Xtender configurations. If several files have been created with different Xtenders, the loaded file is the one that corresponds to the Xtender being used. If the parameters have been backed-up several times at different dates, the last backup will be loaded.

9.7.5.3.3 INSTALLER - Create Xtender configuration file (masterfile) {5033}

This function allows you to create a reference file to parameter the installations-type .This function is used to do a setting only one time and to put it further on several Xtenders or installations.



You only can create one master file by SD card.

9.7.5.3.4 Load Xtender configuration file (masterfile) {5034}

If your installer provides you with a file of parameters for your installation, you can load it by means of this menu. Insert the SD card and launch the loading by pressing the key SET. Caution, the various operations carried out by this process take some minutes.

9.7.5.3.5 Load Xtender parameters preset {5045}

Libraries of predefined parameters are available for specific applications (such as Solsafe). From this menu you can load one of these libraries. You can also combine various libraries.



If two or more libraries handle the same parameter, the value of the last library loaded is used.

9.7.5.4 *INSTALLER - Format the SD card {5047}*

This parameter will completely erase the SD card's current contents.

9.7.5.5 *Start update {5061}*

This parameter will force an update using the contents on the SD card.

9.8 *INSTALLER– MODIFICATION OF ACCESS LEVELS OF MANY PARAMETERS {5042}*

9.8.1 *INSTALLER - Change all parameters access level to: {5043}*

This function enables you to modify the access levels altogether.

9.8.2 *INSTALLER - Restore default access level of all parameters {5044}*

This function enables you to restore the factory access thresholds of the Xtender parameters.

9.9 *BACKLIGHT {5007}*

9.9.1 *Backlight mode {5093}*

With this parameter you can determine if the lighting of the remote control should always be turned on (ON), always be turned off (OFF) or automatically lit for short periods when pressing any one of its buttons (Delayed).

9.9.2 *Backlight switch off after {5009}*

This configuration allows you to determine after how much time of inactivity the backlighting will switch off.

9.9.3 *Red backlight flashing on Xtender off and faulty {5026}*

If the Xtender is stopped by a fault (battery undervoltage, overload, etc.) the backlighting flashes red.

9.10 *EXTENDED AND SPECIAL FUNCTIONS {5021}*

9.10.1 *Display contrast {5006}*

The adjustment of the contrast allows the display to be adjusted in terms of lighting and to a reading position that allows excellent visibility.

9.10.2 *Choice of standard display {5073}*

With this parameter, you can choose the display by default that comes up when exiting from a menu or while connecting the remote control.

9.10.3 Come back to standard display after {5010}

This configuration allows you to determine the time after which the display returns to the basic display if no key is pressed.

9.10.4 Visibility of the transitory messages {5011}

Messages of low importance are displayed for a limited period. This adjustment enables you to adapt this duration at your convenience.

9.10.5 Acoustic alarm active {5027}

In the event of an alarm, an acoustic signal is activated. You can always deactivate this signal by using this configuration.

9.10.6 Remote control acoustic alarm duration {5031}

This parameter enables to adjust the remote control acoustic alarm duration (in seconds).

9.10.7 Switching ON and OFF of system on level "VIEW ONLY" {5056}

If this parameter is deactivated, it is not possible anymore to put the installation ON or OFF with the remote control, should it be at level "view only".

10 INFORMATION ON THE OPERATING MODE OF THE INSTALLATION

There are two different views for displaying information on the system: a simplified and a configurable display. When one of these two displays is visible, it is possible to activate or deactivate the system. For further information, please refer to the paragraph on activating and deactivating the combi Xtender.

The simplified display only indicates the current time and the mode of the Xtender (ON or OFF)

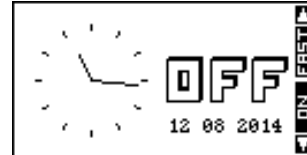

The configurable display shows the system in its entirety, represented by a synopsis of distinct information blocks.

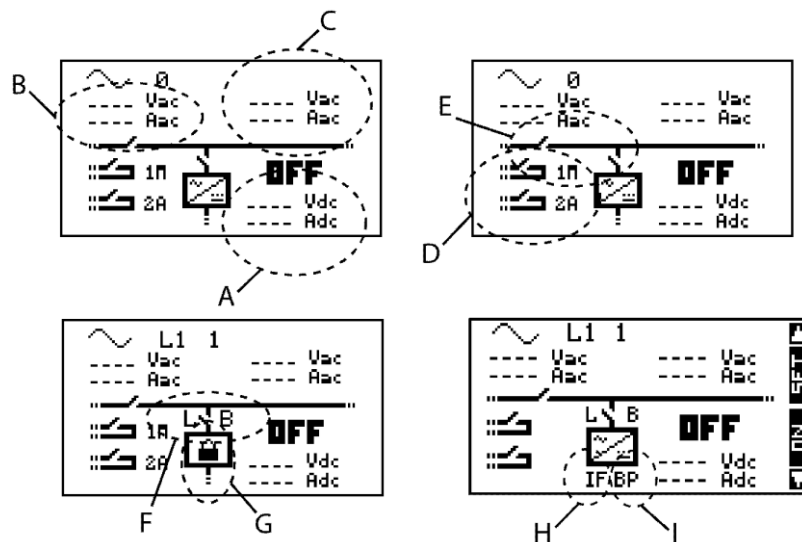

- A Information on the battery
- B Information on the grid input
- C Information on the grid output
- D Information on the auxiliary contacts
- E Information on the transfer and output relays
- F Information on the state of the maximum current of the source (Input limit) (L) and of the Smart-Boost (B: Boost activated, L: input limited)
- G Information on possible locking of the functions inverter, charger and transfer (G)
- H Information on the Injection Forced
- I Information on the Battery Priority

Two pieces of information related to blocks A, B and C may be viewed simultaneously. To change displayed information, proceed as follows:

Press the key SET (one of the pieces of information is displayed in reverse video).

Go to the value to be changed by using the UP and DOWN keys.

Enter into modification by using the key SET. You may now view the values that can be displayed in this area.

Using the keys UP and DOWN, select the new information that you want to see appearing.

Confirm your selection by using the key SET.

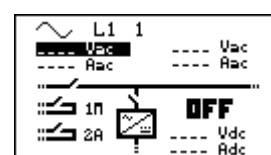

To escape at any time, use the key ESC to return to the starting display.
The following information is available:

With regard to the grid input

- AC-In input voltage (3011)
- AC-In input current (3012)
- AC-In input power (3138)
- Input frequency (3084)
- The value of the source max current (Input limit) (3017)
- Energy from AC-In of the previous day (3080)
- Energy from AC-In of the current day (3081)

With regard to the grid output

- Output voltage (3021)
- Output current (3022)
- Output power (3139)
- Output frequency (3085)
- Consumer energy of the previous day (3082)
- Consumer energy of the of the current day (3081)

With regard to the auxiliary relays

- The event or level that led to switching the relay (3031) (3032)

With regard to the battery

- Battery voltage (3000)
- Actual charge current of the batteries (3005)
- Programmed charge current (3004)
- Ripple voltage of the batteries (3006)
- Charging phase (bulk charge, absorption, float charge, etc.) (3010)
- Dynamic compensation of the battery (compensation of the thresholds due to the internal resistance of the battery) (3003)
- Operating mode (inverter, charger, etc.) (3028)
- Battery temperature (if a sensor is present) (3001)
- The battery temperature's inherent compensation (if a sensor is present) (3002)
- Discharge of battery of the previous day (3076)
- Discharge of battery of the current day (3078)
- State Of Charge of the battery (SOC) (if a BSP is présent in the system) (7002)

If a piece of information is not available, the screen displays - - - -.

Information on the auxiliary relays as well as the output and transfer relays appears as open or closed in the synopsis according to their current state.

Auxiliary relays are indicated with their corresponding number as well as the letter A if they are operating in automatic mode and M if they are controlled manually.

Other letters may be displayed with regard to specific programming. Please refer to the corresponding chapter.

The general operating mode of the combi Xtender is displayed in large letters on the two visualisation screens (ON or OFF).

10.1 DISPLAY OF THE PARALLEL AND THREE-PHASE SYSTEMS

While using several Xtenders in parallel or in three-phase, an additional view is available. This view summarizes the various electrical values of the system. Like for the display of a system with one single Xtender, you can access to the displayed values in order to modify them.

Each summarized view gives access to the display of one Xtender.

In the view of the three-phase, you have access to the detail of one phase by pushing the key SET and then, by pushing UP or DOWN, you can choose the phase you want to see displayed in details.

If the phase consists of several Xtenders in parallel or if the system is a single phase one but with several Xtenders in parallel, you can then have access to the display of each Xtender by selecting in the view parallel one of the three available inverters.

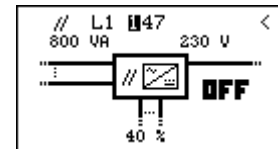
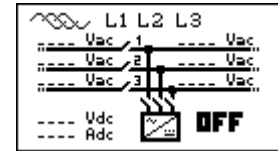

11 MESSAGES AND ACCOUNT OF EVENTS

This screen allows you to view the various events that have occurred in the installation.



The events that occur in your installation are displayed on the remote control screen. The events are classified within two categories:

- The events that may have serious consequences are displayed up to the moment where the user confirms that he has taken note of them by pressing on an RCC remote control key. These events are recorded in the event history and may be consulted subsequently.
- Events not posing a risk are indicated briefly on the display and then disappear. Some are recorded in the event history.

There are four different types of messages:

Notification: general information on the functioning of the installation.

Warning: an event that may cause the system to malfunction or to shut down if not taken care of.

Error: a function of the system has been deactivated.

Halted: The system had to be stopped as a major event is preventing its operation.

Notifications are indicated by their reference number whereas the other messages include both message type and reference number.



Caution, a stop can be temporary and the system can restart automatically. In case of work on the installation, switch off the system.

INSTALLER - In the message history, you may clear the list of saved messages. The clear function is signalled by "CLR", opposite the SET button. You must confirm to clear the list of messages.



Use this function, for example, after maintenance visit or when completing the commissioning of the installation.

11.1 (000) WARNING: BATTERY LOW

The battery is almost completely discharged. If the situation persists, the inverter function of the Xtender will be deactivated.

Solution:

- recharge your battery as soon as possible
- recharge your battery more frequently
- increase the power or the energy available for the load (for instance with more solar panels)



This message is generated in conjunction with the undervoltage of the battery configuration {1108}.



The service life of the batteries is greatly conditioned by their state of charge. Prolonged or repeated operation at a low charge may cause damage. With the Smart-Boost function activated, it is also possible to discharge the batteries even if connected to a source of energy.

11.2 (003) AC-IN SYNCHRONIZATION IN PROGRESS

A valid voltage has been detected on the AC-In input and the Xtender is synchronizing. Once synchronized, the consumers will be transferred to it and the battery will be charged.



Note: It is possible to prohibit the transfer or the battery charging.

11.3 (004) WARNING: INPUT FREQUENCY AC-IN WRONG

The voltage at AC-In does not have a frequency included in the admissible range for the Xtender.
Solution: When operating on a generator, check its speed.



If you are not equipped to measure the generator frequency, measure its voltage with no load. Indeed, if the voltage is correct, the frequency is generally correct as well.

11.4 (006) WARNING: INPUT VOLTAGE AC-IN TOO HIGH

The voltage at AC-In is too high for the Xtender and represents a danger for the consumers; the transfer relay is not activated.

Solution: Reduce the voltage on the AC-In input to come into an admissible range.

11.5 (007) WARNING: INPUT VOLTAGE AC-IN TOO LOW

The voltage at AC-In is too low for the Xtender. The transfer towards consumers and battery charging are not activated.

Solution: Reduce the voltage on the AC-In input to enter an admissible range.



Do not increase the voltage of the generator during battery charging or when the consumers are connected to it: If the consumers stop, an overvoltage may arise which will destroy components of your installation.



If the transfer towards the consumers is carried out and this message appears a few seconds after the start of the battery charging, check the configuration of the maximum current of the source (Input limit) {1107}.

11.6 (008) HALTED: INVERTER OVERLOAD SC

The consumers require more power than the Xtender inverter can supply.

Solution:

- Adapt the maximum power output of your consumers to the maximum power output of the Xtender
- Check that the cabling is not short-circuited.

11.7 (014) HALTED: OVER TEMPERATURE EL

The Xtender stops due to overheating.

Solution:

- Check that the ventilation holes of the Xtender are not obstructed.
- Check that the Xtender is not situated in a place where the ambient temperature is too high.
- Adapt the power max. of the users to the nominal power of the Xtender according to the ambient temperature.



The overtemperature is disadvantageous for the service life of certain electronic components. If the stoppages due to overtemperature happen frequently, corrective measures will be required.

11.8 (015) HALTED: INVERTER OVERLOAD BL

The users need more power than the Xtender inverter can supply.

Method:

- adapt the power max. of the users to the power max. of the Xtender.

11.9 (016) WARNING: FAN ERROR DETECTED

A dysfunction of the ventilation has been detected; get it checked by a technical staff.

11.10 (018) WARNING: EXCESSIVE BATTERY VOLTAGE RIPPLE

The voltage ripple at the battery cables is too high.

Solution:

- Check that the battery cable section is correct.
- Check the tightness of the battery cables.
- Check that the charge current matches your battery.
- Check the state of your batteries.



The use of batteries of an inappropriate capacity may also cause this error message. In this case, reduce the charge current or lower the power output of the consumers.



The voltage ripple on the batteries may be caused by their ageing. In this case, lower the charge current.

11.11 (019) HALTED: BATTERY UNDERVOLTAGE

The functions inverter and Smart-Boost of the Xtender are deactivated because the batteries are discharged.

Method: recharge your batteries to reactivate these functions automatically.

11.12 (020) HALTED: BATTERY OVERVOLTAGE

The voltage of the battery at the Xtender DC input is too high. The system is stopped for security reasons.

Method: check that the battery nominal voltage suits the Xtender one.

In case of an external charger, check that it charges the batteries with a voltage suitable for the Xtender.



In a system with PV panels, check that the solar charge controller is connected to a battery before connecting the PV panels and check its state.

11.13 (021) TRANSFER NOT AUTHORIZED AS AC-OUT CURRENT IS HIGHER THAN INPUT LIMIT {1107}

The power output of the consumers exceeds the one specified for the source, and the transfer relay cannot be activated. The Xtender operates in inverter mode. This situation only occurs if you have deactivated the parameter {1436}.

Solution:

- Check that the configuration of the maximum current for the source {1107} corresponds to the maximum current of the source connected at AC-In.
- Reduce the number or power output of the consumers.



In this case, the transfer relay is not activated and the recharging of the batteries cannot take place. If this situation continues, you might discharge your batteries.

11.14 (022) ERROR: VOLTAGE PRESENCE ON AC-OUT

An unwanted voltage is present at AC-Out.

Solution:

- Check that you have not reversed the cabling of AC input and output.
- No source must be connected to the Xtender output (AC-Out).
- Check the cabling of the installation.

11.15 (023) HALTED: PHASE NOT DEFINED

The jumper of phase selection (L1, L2 ou L3) is missing on the Xtender. The Xtender cannot operate without the phase being defined.

Solution: Check the phase definition jumper in the cable connection zone. Refer to the Xtender manual for more information.

11.16 (024) WARNING: CHANGE THE CLOCK BATTERY

The maintenance battery is discharged. To avoid that the clock goes back to zero in case of a blackout, its replacement is necessary. Refer to the Xtender manual for this replacement.

11.17 (041) ERROR: OVER TEMPERATURE TR

The temperature of the Xtender is excessive and the output power is limited.



Check that there is sufficient ventilation around the Xtender. This message can also occur after a long operation in a too hot environment.

11.18 (042) HALTED: UNAUTHORIZED ENERGY SOURCE AT THE OUTPUT

An energy source has been detected at the AC-Out output and it supplies current to the Xtender.

Method: check that you do not have an energy source connected to the output.



If there is a need for supply on the output side (back-feeding), use parameter {1438}. Only energy sources meant for such feeding and synchronization can be used.



For operation with a grid feeding inverter, it is possible to control the load of this inverter, see parameters {1438}, {1536} and {1549}.



In no case will the feeding source power be bigger than the Xtender power.

11.19 (058) HALTED: MASTER SYNCHRONIZATION MISSING

A communication problem between the Xtenders is detected.

Method: check the cabling in between the Xtenders.

11.20 (059) HALTED: INVERTER OVERLOAD HW

See code (015).

11.21 (060) (061) WARNING: TIME SECURITY FOR AUXILIARY CONTACTS

The maximum duration that you have selected for the relay activation with the parameter {1514}, {1515} is reached and the activation conditions are still present. The contact will not be reactivated as long as the conditions are present. Therefore, there is a risk that the auxiliary contact remains locked in this position unless you reset this alarm.

Method: reset manually this alarm with the corresponding parameter ({1512}AUX1, {1513}AUX2) by deactivating and then activating it.



Use this function with care and only as a security.

11.22 (062) WARNING: GENSET, NO AC-IN COMING AFTER AUX COMMAND

The genset start has been driven by the auxiliary contact but there is no voltage at the Xtender input. Method: check that the genset runs and that its connection to the Xtender has not been interrupted.

11.23 STORED EVENTS

Events are stored in the remote control. Any system not permanently connected to a remote control does not store the events.

To access the event history via one of the basic displays, change the screen by using the keys UP and DOWN until the "event history" screen appears and then validate using the key SET.

The number shown at the top right indicates the message number. In a system with several Xtenders, the events are presented in chronological order and the lower line indicates the Xtender to which the event refers. Each event is recorded as well as the date and time of its occurrence. The keys UP and DOWN allow you to view all the events that have occurred.

Where there is a system with multiple Xtenders, each message also contains the number of the Xtender that has generated the message.

Quit the message display by using the key ESC.

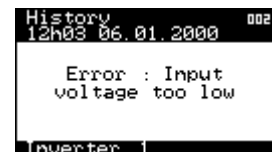

These messages can be exported on a SD card, which allows their transmission or their use on a computer.

12 DATA LOGGING

The remote control RCC-02/-03 offers a function that allows recording many electrical values of your system over a long time.

With this function you can for instance follow the energy consumption and the battery voltage, or see the power cuts, the state of the auxiliary relays, the input currents and voltages, the output powers etc...

This enables you to work out statistics, to check the system operation or its sizing, to verify the loads behaviour, to anticipate or to detect failures.

12.1 FUNCTIONING

If the data logger is activated, a file is created at midnight every day on the SD card inserted in the remote control. This file contains the data of the Xtender system components as well as the recordings of the system electrical values, minute after minute. The file is registered in CSV format that can be read by many types of software. The file name integrates the date of the measure in this form: LGaammjj.csv. In case no SD card was inserted, the daily data will be lost.

If the data of the current day have to be available for analysis, it is possible to create a file manually during the day with the data already available.

The remote control software updating will lead to the erase the daily data.

12.2 ANALYSIS AND VISUALIZATION OF THE DATA WITH THE XTENDER DATA ANALYSIS TOOL

Attached to this function, Studer Innotec offers free of charge an analysis tool in the form of a file type Microsoft® Excel® 2007 which allows reading specifically the CSV files generated by the remote control. This tool shapes and gathers the data of each Xtender and then displays them graphically. In this way the data become readable and understandable at a glance.

These files can be downloaded for free on www.studer-innotec.com/en/downloads/

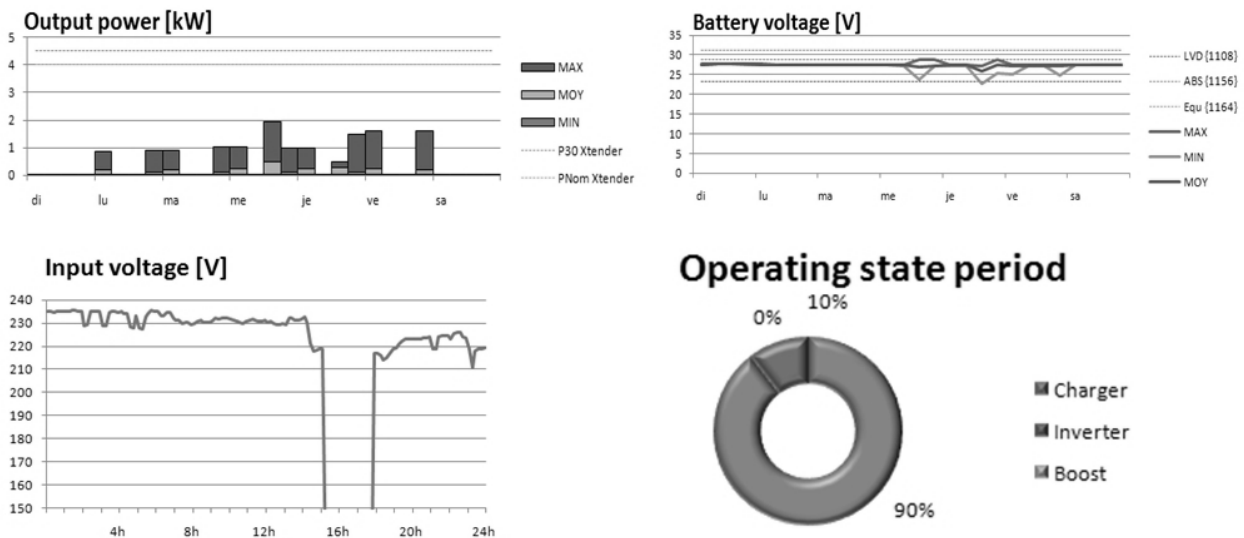

13 XTENDER SETTINGS

A complete list of the accessible parameters can be found at the end of this manual.

13.1 GENERAL

The Xtender inverter/charger has been designed to ensure that all basic functions of an energy management system work completely independently. In its original version, no adjustment is required apart from setting the battery charge current {1138} and the maximum current of AC source (input limit) {1107}.

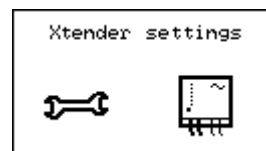

Caution, a hazardous setting of the parameters may lead to a disfunctioning of the whole installation, or event to damaging it.

Nevertheless, in certain installation conditions, it may be necessary to adjust some operating configurations. This is why the RCC remote control gives access to the adjustment of many configurations and within a range largely exceeding the usual values. Use these adjustment options with care and only with due specialist knowledge. Changing configurations is not the responsibility of Studer Innotec. Please refer to the chapter on limitation of responsibility for more information on this topic.

13.2 CONFIGURATION ON A SYSTEM WITH SEVERAL XTENDERS

When there is a system to which several Xtenders are connected, the changing of a configuration is global. It will be applied to all the Xtenders connected together. To carry out adjustments on a single Xtender, it is necessary to remove the connection cables and only keep the connection between the remote control and the Xtender on which the different adjustments is being carried out. It is therefore possible to configure each Xtender of a system independently. Once the configuration has been carried out, the original connection can be re-established.



Note: If you have carried out an individual configuration, once a configuration has been changed, the system reconnected by the data connection cable modifies this configuration for all the Xtenders connected.



Caution, in case of a different connection of the devices, the rule regarding terminations must be applied and the devices shut down and restarted.

13.3 UTILISATION AND ACCESS LEVELS

The functions described below refer to the EXPERT level. Depending on the user level selected, access to all the functions may not be possible. Refer to the chapter on setting the user level of the remote control for more information on this subject.

13.4 PRE-DEFINED FUNCTIONS OF THE AUXILIARY RELAYS

The two auxiliary relays (dry contacts) of the inverter/charger Xtender are already programmed with factory settings and can be activated with various functions. They react to different signals. For more information on the auxiliary contacts pre-set functions, please see the inverter/charger Xtender manual.



Caution, if your installer or supplier has done pre-settings, these pre-set functions may have been changed.

13.5 ACCESS TO THE PARAMETERS

You can access to the parameters by two different ways:

- By its reference number;
- Via the thematic menu.

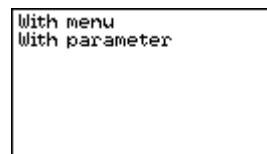

13.5.1 Access to a parameter by its number

Each Xtender parameter is directly accessible by its unique reference number. This function can be used in order to change the value of a parameter or to consult its set value.

If you know the reference number of a parameter that you want to change, you can access to it directly with this menu. Move with the keys UP and DOWN to highlight the parameter then select it by the key SET. You have then the possibility to change the value of this parameter.

For each parameter, its set value is written opposite to it. If a parameter does not have a value displayed, this means that you do not have the user level required to change the value or that the parameter does not have a value (a menu title for instance).

When you want to access to a parameter which access level is superior to yours, it is possible to do it only with a code: select the parameter that you want to change with the keys UP and DOWN then press the key SET. The remote control then displays a 4 digits number. By communicating this number to your installer, you can receive an activation number which will allow to modify the wanted parameter.

The key received is valid only for one single access to the wanted parameter. This is why it can be necessary to be online with your installer when it comes to do several changes.

13.5.2 Access to a parameter via the menu

The Xtender configurations are divided into several categories:

- Basic configurations
- Battery and its charge cycle configurations
- Inverter configurations
- The parameters of charger and input signals
- First auxiliary contact configurations
- Second auxiliary contact configurations
- Auxiliary contact extended function configurations
- The parameters of the system
- Three-phase or parallel operation configurations
- The parameters of grid feeding

According to the user level selected, it is possible to access several hundred configurations. For this reason, each configuration has a unique ID displayed top right. In the event of questions on the subject of a configuration, ensure that you have this number at hand.

When you modify a configuration, a star is displayed to the left of the value if it corresponds to the factory-set value.

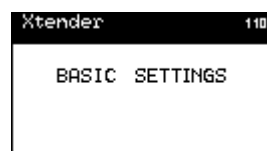

The various configurations can be adjusted within a large range. Nevertheless, some configurations are interdependent and cannot be adjusted beyond the value of other configurations. You can consult the list of dependencies on the list in appendix 1.

13.6 INSTALLER - UTILISATION AND ACCESS LEVELS

The configurations of the Xtender are defined by the following elements:

- The minimum
- The value
- The maximum
- The user level necessary to access it

When in client mode (Basic or Expert), the remote control gives access to the different configuration values. In INSTALLER or installer mode, you have access to the other elements. This means that you can define the minimum and the maximum of each setting. The values remain limited, however. You can also determine the minimum access level for each parameter.

If the element is preceded by a star, it means that it is the same as the factory setting.

```
Xtender 1107
Max source AC
current
(Power Sharing)
*30.0Aac
```

```
Xtender 1107
Max source AC
current
(Power Sharing)
2.0/30.0/50.0/BA
```

When you access a setting for modification, you can adjust successively the minimum, the default value, the maximum, and the user level necessary to access each setting.



The user level is represented by an abbreviation. You can make the setting accessible from BASIC, EXPERT, INSTALLER or QSP level.

Use the following values for the levels:

Accessible to Basic level: BA

Accessible to Expert level: EX

Accessible to Installer level: IN

Accessible to QSP level: QS



Use this function if you wish to remove the possibility for clients to set a parameter of the Xtender.

13.7 BASIC SETTINGS {1100}

The basic configurations serve to adapt the Xtender characteristics to the elements that surround it. Use these configurations in order to optimize the operation of the inverter/charger and to benefit from the maximum performance of your installation.

13.7.1 Basic parameters set by means of the potentiometer in the XTS {1551}

With this option you can choose whether the setting buttons in the XTS are active or not. When they are, the corresponding functions are not displayed on the remote control (RCC). The settings carried out by the buttons integrated can not be seen either in the remote control or in the backup files.

13.7.2 Maximum current of AC source (Input limit) {1107}

Adjust this configuration in the event of connection to a limited power source, for example, a generator of moderate power output or a dock or camping connection. The adjustment of this value limits the instantaneous power consumed from the source in charger mode. The power available is attributed by first priority to consumers and then to battery charging. If the consumption level changes, the battery charge current is automatically adjusted.

- A. Power available and used to recharge the batteries
- B. Maximum AC source current (adjusted to 10 A here)
- C. Consumer current
- D. Power supplied by the inverter (Smart-Boost function)

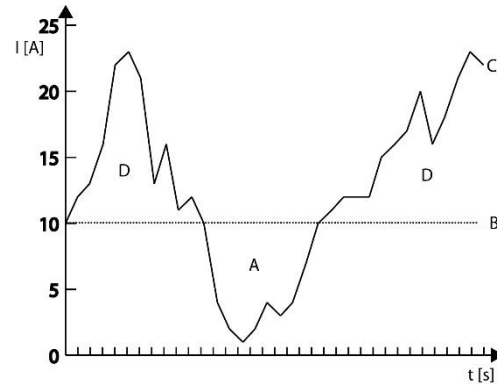

If the consumption level is higher than the controlled level, the maximum source current will be exceeded, except when the Smart-Boost function is activated.



If the maximum current is exceeded it is possible to open the transfer relay by using the parameter "Overrun AC source current limit without opening the transfer relay (Input limit)" {1436}.



It is possible to access this function faster, please refer to page 14.

13.7.3 Battery charge current {1138}

Use this value in order to adapt the charge current to the battery. With this configuration, the maximum current to be used for charging your battery is adjusted. The current appropriate for the battery can be found in its technical data. The value set by this configuration is used during the whole bulk charge phase.



Use this setting to adapt the charge current only with regard to the battery. To adapt the charge current to your source, use the parameter for maximum current at the source "Input limit" {1107}. The right setting of these two values is essential for correct operation as well as the lifetime of your installation.

13.7.4 Smart-Boost allowed {1126}

The function Smart-Boost enables to add power from the batteries to the one supplied by source connected to the AC-In when the user load is higher than that, set by the parameter {1107}, as a maximum input. This function is active by default.

When the battery comes close to undervoltage the smart-boost function is gradually reduced in order to avoid a power-cut of the Xtender. The reduction range is 0.25/0.5/1V in installations of 12/24/48V.

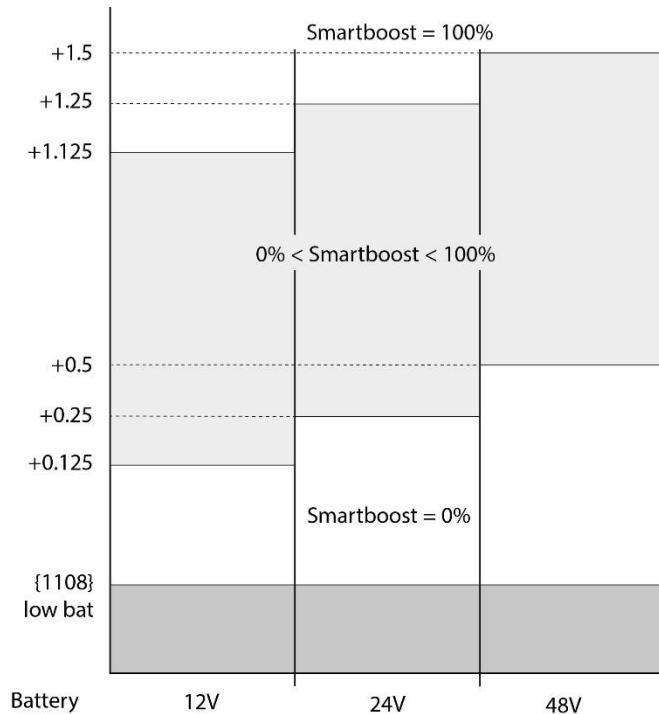

When the Smart-Boost function is active, it is possible to discharge the batteries, even if the Xtender is connected to a source and the charger is active.

13.7.5 Inverter allowed {1124}

This configuration authorizes operation in inverter mode. If the inverter is deactivated, a voltage will be present on the output terminals (AC-Out) only if a correct voltage is present at the input (AC-In) and the transfer is not prohibited.



This function can be used for supplying non-critical consumers while ensuring that the battery is not discharged even if the source is faulty.



Note, that if the Smart-Boost function is activated, it is possible to discharge the battery even if the inverter function is locked.

Where there is lock on the inverter, charger or transfer function, a small padlock is displayed on the configuration display.

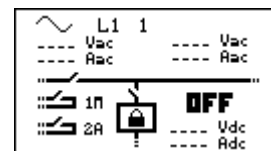

13.7.6 Type of detection of the grid loss (AC-In) {1552}

The disappearing of the input voltage (AC-In) leads to the transfer relay opening and to the inverter activating. This detection works in three possible speeds.

The function "slow" suits specially well the small generators but may create microcuts on the grid at the output (AC-Out) during commutation. This function will let some fluctuation of the input voltage and frequency before reacting.

The function "fast" fits very well with sensitive loads that require few or no cut to work.

The function "tolerant" lies in between and its sensitiveness can be set with the parameter {1510}. The range for {1510} goes from 2 to 120, where 2 is equivalent to the setting "fast" and 120 is equivalent

to “slow”. In this way it is generally possible to use small generators also with loads sensitive to microcuts.

13.7.7 Standby level {1187}

The standby function allows energy to be saved if there is no consumer present at the inverter output. In this case, the inverter disconnects its output and periodically emits a load search pulse. If a consumer is detected, it goes back into operational mode while measuring the power supplied and returns to standby if the consumer is deactivated.

This configuration allows adjustment of the power output at which the inverter goes into standby mode.

Proceed as follows to adjust this configuration:

Make sure that the inverter mode is active (no voltage present at the AC-In input). The input voltage is 0 and the input relay is indicated as open in real time on the information screen.

Increase the standby level value {1187} to the maximum

Activate the smallest consumer that can be detected and ensure that all the others are deactivated.

Wait for the inverter to pass to standby, and the consumer then engages intermittently around once a second.

Progressively reduce the standby level value {1187} until the consumer runs permanently. If the consumer works for several seconds then stops, decrease the value of the standby level again.

An adjustment value between 0 and 100 is displayed. The value 100 represents the minimum sensitivity (biggest consumer detected).



If you would like to deactivate the standby function, it is sufficient to adjust the detection level to 0. In this case, the Xtender remains permanently activated if it is working in inverter mode.

13.7.8 Restore default settings {1395}

Use this function to re-establish the original combi Xtender adjustments.



If your installer has carried out settings while commissioning your installation, this function brings back these settings and not the factory settings.

13.7.9 INSTALLER - Restore factory settings {1287}

This function allows you to go back to the settings which were set at the factory. For each setting, not only its factory value is restored, but also its limits and its user level.

When the factory settings are restored, the Xtender programme shuts down and restarts, like when it is switched on (reset).

13.8 BATTERY MANAGEMENT AND CYCLE {1137}

These configurations are intended to adjust the battery charge cycle to the data supplied by its manufacturer. The basic battery cycle is described in the Xtender manual.

 Caution: the Xtender charger is by default set to charge lead batteries.

 Note: Incorrect values may lead to early ageing or even destruction of the batteries.

For further information, contact your battery supplier who will give you the correct values. The graphic presentation of the battery cycle shows the options for linking the various phases:

Minimum battery cycle

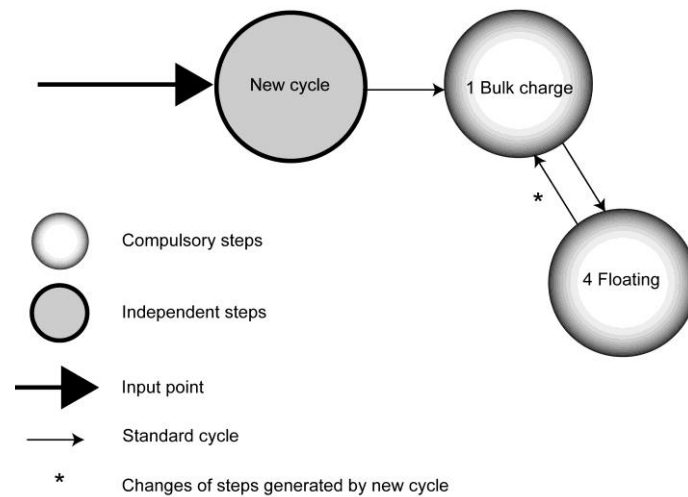

The bulk charge and floating phases cannot be deactivated. If the conditions for starting a new battery charge cycle are fulfilled, the bulk charge phase starts immediately. In order to remove the voltage spike set the Absorption voltage {1156} to be identical to the Floating voltage {1140}.

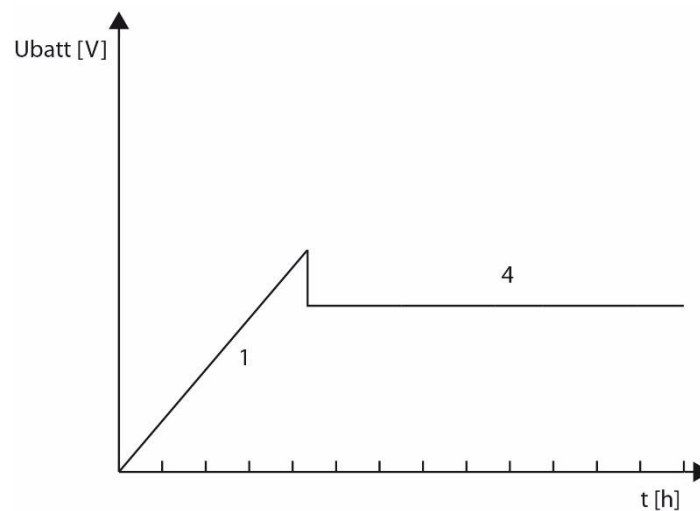

Default battery cycle

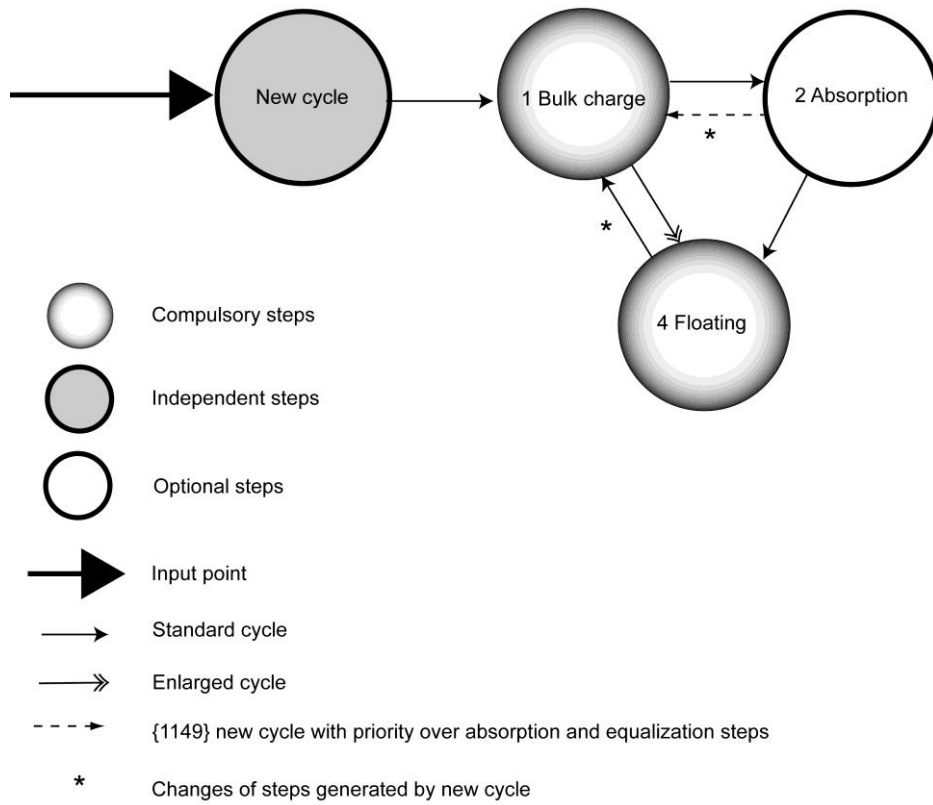

The battery cycle fits a large number of batteries by default, irrespective of whether they are gel batteries or not.

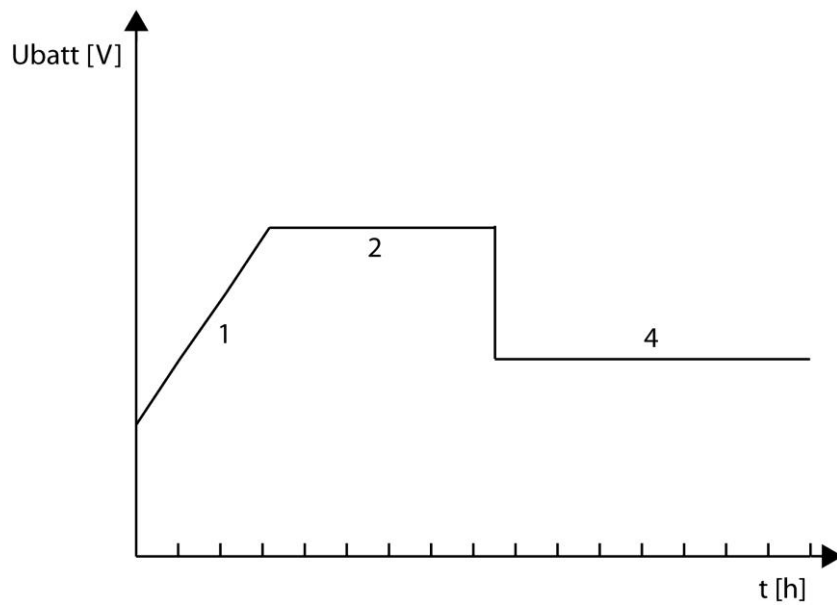

Complete battery cycle

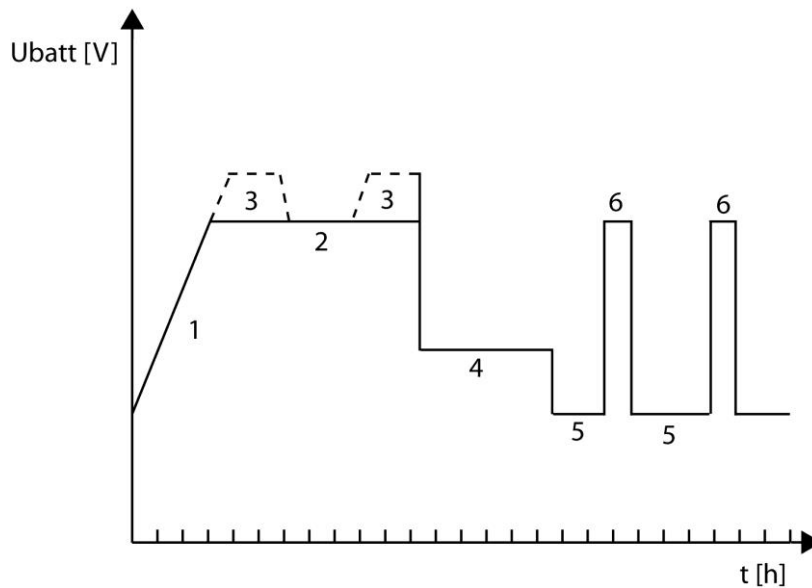
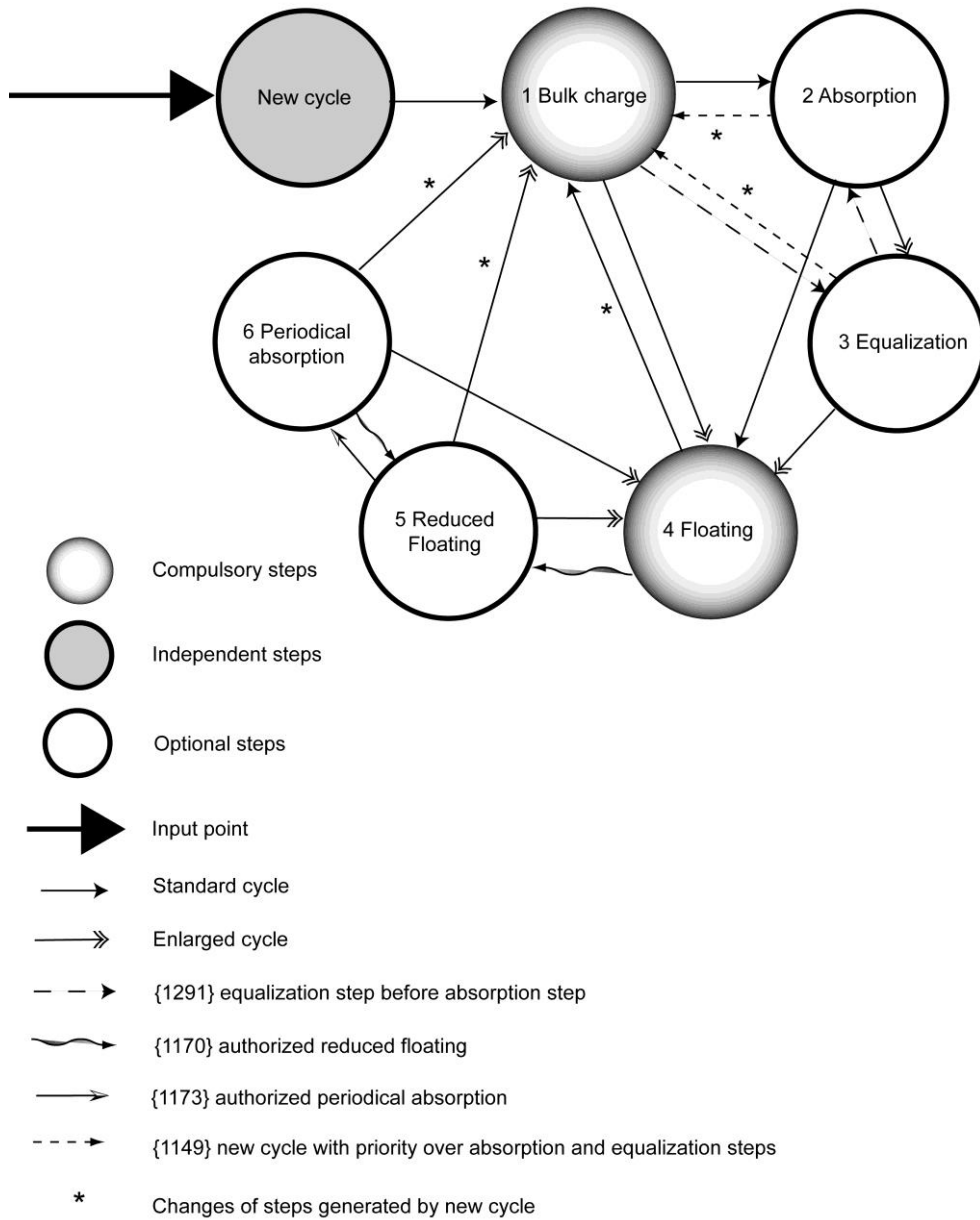

13.8.1 Charger allowed {1125}

The battery charger function is either activated or not. If this function is not authorized, it is necessary to charge the batteries using a source of energy not connected to the Xtender.

Where there is lock on the inverter, charger or transfer function, a small padlock is displayed on the configuration display.

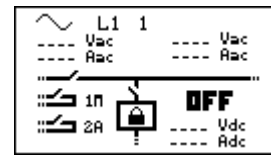

13.8.2 INSTALLER - Charger uses only power from AC-Out {1646}

This parameter is used to limit the source of energy used to charge the battery to current coming from AC-Out. If this parameter is set to No, the charger will use current coming from AC-In and/or AC-Out. This parameter is intended to increase the use of energy from an AC-coupled source connected to AC-Out to charge the battery.

13.8.3 Battery charge current {1138}

Use this value in order to adapt the charge current to the battery. With this configuration, the maximum current to be used for charging your battery is adjusted. The current appropriate for the battery can be found in its technical data. The value set by this configuration is used during the whole bulk charge phase.



Use this setting to adapt the charge current only with regard to the battery. To adapt the charge current to your source, use the parameter for maximum current at the source (Input limit) {1107}.
The right setting of these two values is essential for correct operation as well as the lifetime of your installation.



If you do not have any indication of the charge current, the most commonly used value is a fifth of the capacity. Ex. for 500Ah: $500/5 = 100A$.
Caution, if your batteries are in serie, the capacity for the formula above is only that of one battery and not the sum of them.

13.8.4 Temperature compensation {1139}

If a battery temperature sensor is used (BTS or BSP), the charge and discharge voltages are automatically adapted to the temperature of the batteries. The compensation is given in millivolts by degree Celsius (°C) and by battery cell. The discharge thresholds are not compensated.

13.8.5 Undervoltage {1568}

13.8.5.1 Battery undervoltage level without load {1108}

Allows adjustment of the battery's low voltage level at which the inverter and Smart-Boost functions are deactivated. This adjustment is applied in the case of a zero charge and is automatically adapted with regard to the power required from the batteries. This configuration is a factory setting for lead-acid batteries. Poor adjustment of this value leads to early ageing of the batteries due to deep discharges.

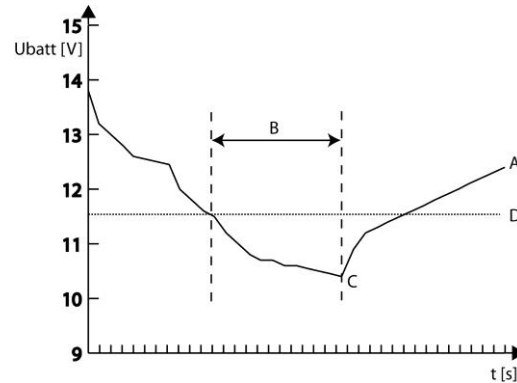

- A. Battery voltage.
- B. Duration of undervoltage before disconnection {1190}.
- C. Disconnection due to undervoltage.
- D. Battery undervoltage level without load {1108}.

Adjust this configuration using the technical data for your battery.



The battery undervoltage level is automatically adapted to the instantaneous power of the consumers to compensate for internal losses in the battery and cables.

13.8.5.2 Battery undervoltage dynamic compensation {1531}

13.8.5.2.1 Battery undervoltage dynamic compensation {1191}

This setting allows you to activate (or not) the dynamic battery undervoltage compensation. If this setting is deactivated, the disconnection voltage is identical, whatever the charge on the inverter of the Xtender.

13.8.5.2.2 Kind of dynamic compensation {1532}

This parameter enables you to choose between an automatic and a manual dynamic compensation. If you use the manual compensation, you must adjust the parameter {1109} "Undervoltage at full load".



Using the manual mode of dynamic compensation in systems with several Xtenders may cause malfunctioning of the system as the Xtender will not take into account the voltage of the other inverter/chargers.

13.8.5.2.3 Battery undervoltage level at full load {1109}

The battery undervoltage is adapted to the nominal current of the inverter (dynamic undervoltage compensation). You can adapt the disconnection voltage to the nominal charge of the inverter, according to your battery specifications.

13.8.5.3 Battery undervoltage duration before turn off {1190}

If the battery voltage is beneath the disconnection threshold, the inverter and Smart-Boost functions are deactivated, but not immediately. This setting allows you to adjust the delay between falling below the disconnection threshold and the current disconnection.

13.8.5.4 Restart voltage after batteries undervoltage {1110}

When the Xtender has shut off the inverter function following a battery undervoltage, it starts up again if the battery voltage returns to acceptable value. This setting allows you to fix the voltage at which the inverter and Smart-Boost functions are reactivated.

13.8.5.5 Battery adaptive low voltage (B.L.O) {1194}

A battery permanently operating when it is practically discharged sees its lifetime drastically reduced. In order to force the client to recharge the battery, the undervoltage threshold may be increased with each undervoltage disconnection. The low threshold is increased with each disconnection, and returns to its original value if the battery has been recharged up to a certain voltage. For this reason, the client will not be able to constantly discharge the battery without at least having recharged it. The algorithm B.L.O. (Battery Lifetime Optimizer) is activated with this parameter.

13.8.5.6 Max voltage for adaptive low voltage {1195}

The undervoltage threshold is increased with each undervoltage, but never higher than the value set with this parameter.



Be aware that this value is limited to the voltage of the fully charged battery

13.8.5.7 Reset voltage for adaptive correction {1307}

The battery undervoltage threshold returns to its original value if the battery reaches the voltage determined by this threshold.

13.8.5.8 Increment step of the adaptive low voltage {1298}

At each shut down by undervoltage, the shut down threshold is increased by this value.

13.8.6 Battery overvoltage level {1121}

This setting allows you to adjust the maximum battery voltage for operation in inverter mode.

13.8.7 Restart voltage level after an battery overvoltage {1122}

In case of a battery overvoltage, the battery has to return to a voltage lower than the value fixed by this setting in order to unlock inverter operation. If the auto-restart after overvoltage function is activated, the Xtender will automatically restart once the battery voltage has gone beneath this value.

13.8.8 Floating voltage {1140}

Use this configuration to adjust the voltage that will be used when the battery is completely charged. This voltage prevents automatic discharging and maintains the battery at its maximum level of charge.

13.8.9 Force phase of floating {1467}

This configuration may be used to force a battery cycle in progress and to bring it to the end of charge values. If the battery voltage level is higher, the charger is temporarily disconnected. If the battery level is lower, the charging current is increased up to the maximum in order to reach the set level as quickly as possible.

13.8.10 New cycle menu {1141}

Battery charging is a complex function that generally ends with a maintenance phase (floating) of indeterminate duration. The configurations below allow adjustment of the conditions that lead to the starting of a new charge cycle.

13.8.10.1 Force a new cycle {1142}

This configuration allows a new charge cycle to be forced, and the bulk phase follows straight away.

Voltage level 1 to start a new cycle {1143} and time period under voltage level 1 to start a new cycle {1144}

Voltage level 2 to start a new cycle {1145} and time period under voltage level 2 to start a new cycle {1146}

The battery voltage value, below which a new cycle is started, can be specified. The battery voltage must remain below this threshold for the duration that is also to be determined. Two voltages associated with two durations are configurable. Generally, a higher voltage is used with a longer duration and a lower voltage with a shorter duration.

13.8.11 INSTALLER - Use dynamic compensation of battery level (new cycle) {1608}

This parameter makes it possible to take into account the instant power needed to launch a new charge cycle.

13.8.11.1 New cycle priority on absorption and equalization phases {1149}

Activate this configuration to accept or interrupt the absorption and equalization phases to start a new cycle. In the opposite case, even if the conditions are fulfilled for starting a new charge cycle, the battery charging proceeds normally by following the programmed phases.



In the event of battery charging with renewable energy sources such as solar energy, for example, this configuration must remain deactivated (*no) in order to avoid cycles taking place too frequently.

13.8.11.2 Cycling restricted {1147}

13.8.11.3 Minimal delay between cycles {1148}

If you wish to limit the frequency of the charge cycles, this setting allows you to lock the system so that a new battery charge cycle will not be initiated, even if the conditions for doing so have been met. The duration of the lock does not depend on the duration of the cycle. It takes into account the duration between the start of each cycle.

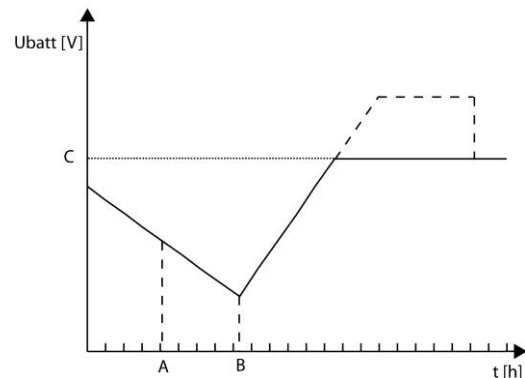

- A: New cycle
- B: Presence of AC-In source
- C: Floating voltage



If you activate this function and you adjust the duration setting to 24h, you will only have one charge cycle per day. In this case, if the conditions for a new cycle are met, the cycle will not take place and the charger will keep the battery at floating voltage.

13.8.12 Absorption phase {1451}

During this phase, the battery accumulates the final percentages of the energy it is storing. This phase is carried out with a constant voltage.

13.8.12.1 Absorption phase allowed {1155}

This configuration determines whether or not the absorption phase is used. If this phase is deactivated, the charger goes directly to the authorized phase that follows it.

13.8.12.2 Absorption voltage {1156}

Use this configuration to adjust the voltage that is used for the absorption phase.

13.8.12.3 Absorption duration {1157}

Use this configuration to adjust the duration of the absorption. The absorption phase starts once the set voltage {1156} is reached. When the duration has run out, the charger automatically goes to the authorized phase that follows it.

13.8.12.4 End of absorption triggered with current {1158}

The absorption phase may be interrupted if the battery charge current automatically passes below a certain threshold. This may be used in order to limit the duration of the operation of a generator while there is an acceptable battery charge.



During the absorption phase, as a matter of fact, the charge current reduces progressively. If the bulk charge has been carried out with a current which is correct for the battery, it is not necessary to adhere to a fixed duration to end the charging.

13.8.12.5 Current limit to quit the absorption phase {1159}

Set the current value below which the absorption phase is considered to be at an end. When the current of the charger goes below this value, the next step starts.



The charge current of the Xtender that is responsible for the battery cycle (master Xtender in multi-Xtender system) is used to determine the end of the absorption cycle, not the total current delivered to the battery. Therefore, the function activated by {1159} is not applied when other devices are synchronized with the Xtender (e.g. VarioTrack or VarioString).

13.8.12.6 Maximal frequency of absorption control {1160}

13.8.12.7 Minimal delay since last absorption {1161}

These parameters enable to limit the frequency of the absorptions. You can freely set the period during which no further absorption will be carried out. If a new battery charge cycle is activated, the battery will be charged until absorption voltage, but once this voltage is reached, the battery charging will go automatically to the next phase (usually floating).

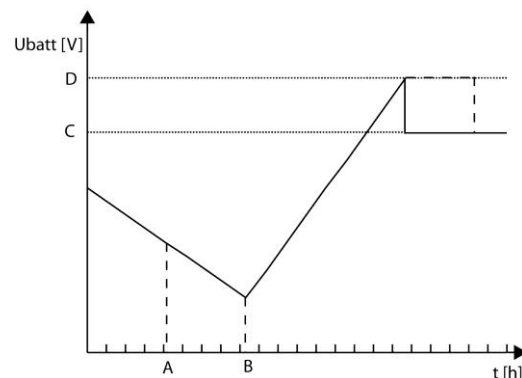

- A: New cycle
- B: Presence of source
- C: Floating voltage
- D: Absorption voltage

13.8.13 Equalization phase {1452}

Certain types of battery require equalization in order to avoid the stratification of water and acid that they contain. Use the configurations below in order to adjust the usage conditions for this charge phase.



During an equalization phase, a large quantity of gas is released that is highly explosive (hydrogen). Ensure that you adhere to the battery manufacturer's instructions for this function. In all cases, ensure that there is sufficient ventilation around the batteries.



During the equalization phase, the water of the battery is separated into gases (hydrogen and oxygen) and this action serves to decrease the level of liquid in the batteries. Check their level regularly.

13.8.13.1 Equalization allowed {1163}

This configuration determines whether the equalization may be used on the installation.

13.8.13.2 Force equalization {1162}

Use this configuration to force the start of an equalization phase.



It is only possible to force an equalization phase if the equalization is authorized. Once the phase has started, prohibiting the phase does not stop the equalization. To stop the equalization, use Force passage to maintenance (floating) or Force new cycle.

13.8.13.3 Equalization before absorption phase {1291}

This configuration determines in the charge cycle, in which equalization will be activated, if the equalization is carried out after or before the absorption phase. The equalization phase is carried out before the absorption phase by default.

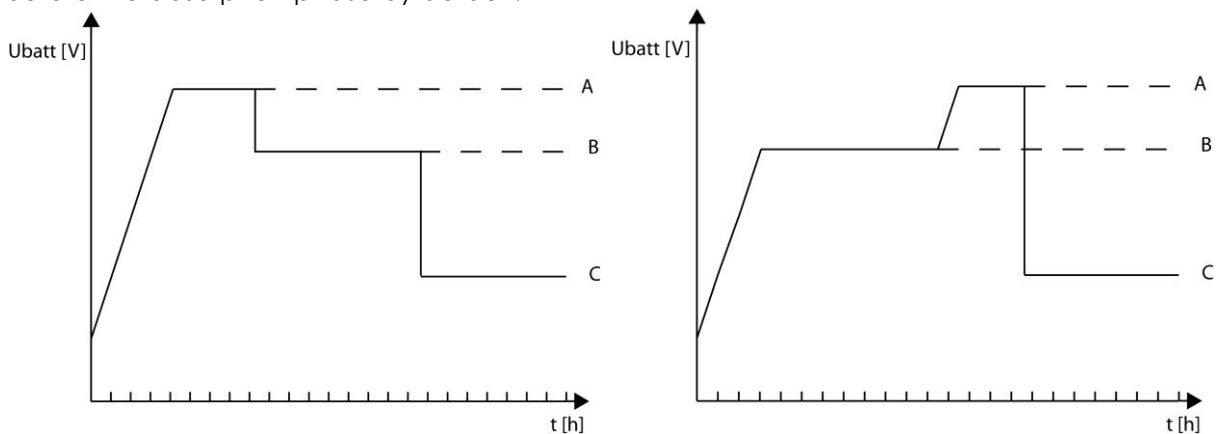

- A. Equalization
- B. Absorption
- C. Floating

13.8.13.4 Equalization current {1290}

The equalization phase can be carried out with a limited current, which can be adjusted using this configuration. In all cases the current does not exceed that of the bulk charge phase {1138}.

13.8.13.5 Equalization voltage {1164}

Set the voltage at which the equalization is carried out using this configuration.

13.8.13.6 Equalization duration {1165}

Use this configuration to adjust the duration of the equalization. The equalization phase starts once the set voltage {1164} is reached. When the duration has run out, the charger automatically goes to the authorized phase that follows it.

13.8.13.7 Number of cycles before an equalization {1166}

Equalization is not carried out at each charging cycle. This configuration allows the number of charging cycles to be adjusted where equalization is not active.

13.8.13.8 Equalization with fixed interval {1284}

In the event of usage with few charge cycles, it may be necessary to carry out equalization cycles at set intervals and not with a number of set cycles. If this configuration is activated, a new battery charge cycle with an activated equalization phase with the programmed interval is started {1285}.

13.8.13.9 Weeks between equalizations {1285}

Use this configuration to determine the time intervals that separate the battery charge cycles with active equalization phases.



Should incomplete charge cycles occur (for example, when charging by using solar generators); this function is also useful in order to limit the frequency of equalization cycles.

13.8.13.10 End of equalization triggered with current {1168}

The equalization phase can be interrupted if the charge current of the battery goes under a certain threshold. This can be used to limit the operating period of a genset while keeping an acceptable battery charge.



During the equalization phase, the charge current decreases progressively in a natural way. If the bulk charge has been achieved with a current suitable for the battery, it is not necessary to respect a fixed period to complete the charge.

13.8.13.11 Current threshold to end equalization phase {1169}

Set the current under which the equalization phase will be considered as completed. When the charge current goes under this value, the next phase starts.

13.8.14 Reduced floating phase {1453}

In case the batteries are in low demand, the reduced floating phase may be activated. This phase makes it possible to reduce water consumption. In any case, respect the charge curve supplied by your battery manufacturer.

- A: Absorption phase
- B: Floating phase
- C: Duration before reduced floating phase
- D: Reduced floating voltage

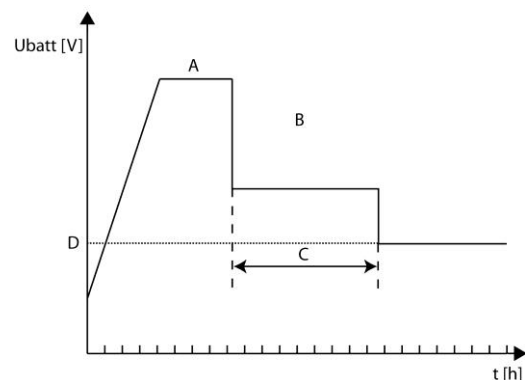

13.8.14.1 Reduced floating allowed {1170}

Allows you to authorize the reduced floating phase.

13.8.14.2 Floating duration before reduced floating {1171}

The reduced floating phase begins after the floating phase. This setting allows you to fix the duration of the floating phase, which precedes the reduced floating phase.

13.8.14.3 Reduced floating voltage {1172}

Allows you to set the battery voltage for the reduced floating phase.

13.8.15 Periodic absorption phase {1454}

The floating and reduced floating phases cause the stratification of the acid and the water in the batteries. The periodic absorption phase allows you to counter this problem.

- A: Duration of reduced floating before periodic absorption {1175}
- B: Periodic absorption voltage {1174}
- C: Duration of periodic absorption {1176}

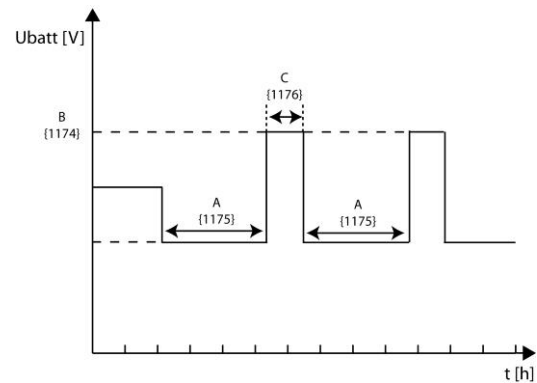

13.8.15.1 Periodic absorption allowed {1173}

Allows you to authorize the periodic absorption phase.

13.8.15.2 Periodic absorption voltage {1174}

Allows you to fix the battery voltage for the periodic absorption phase.

13.8.15.3 Reduced floating duration before periodic absorption {1175}

The periodic absorption phase begins after the reduced floating phase. This setting allows you to fix the duration of the reduced floating phase, which precedes the periodic absorption phase.

13.8.15.4 Periodic absorption duration {1176}

This setting fixes the duration of the periodic absorption. Once this duration has elapsed, the battery returns to the reduced floating phase.

13.9 INVERTER {1186}

To set the different parameters of the function inverter, use this menu.

13.9.1 Inverter allowed {1124}

This configuration authorizes operation in inverter mode. If the inverter is deactivated, a voltage will be present on the output terminals (AC-Out) only if a correct voltage is present at the input (AC-In) and the transfer is not prohibited.



This function can be used for supplying non-critical consumers while ensuring that the battery is not discharged even if the source is faulty.



Note, that if the Smart-Boost function is activated, it is possible to discharge the battery even if the inverter function is locked.

Where there is lock on the inverter, charger or transfer function, a small padlock is displayed on the configuration display.

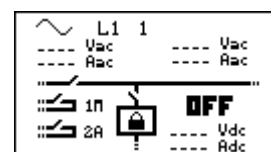

13.9.2 AC-Output voltage {1286}

The output voltage can be adjusted using this configuration.



In certain fields of application – for example, when the energy source is limited (solar or generator only) – it may be useful to reduce the output voltage of the inverter. This generally leads to a resulting reduction in the energetic consumption without significantly decreasing comfort. For example, a 100 W light bulb consumes around 100W to 220V and 15% more at 230V.

13.9.3 AC voltage increase according to battery voltage {1548}

This parameter enables you to set that the output voltage is influenced by the batteries voltage. The function depends on the batteries charge cycle and uses the reference voltage of the running cycle. For instance: if the battery is carrying out in the absorption phase, the output voltage will be modified close to this setting value. If the battery is in floating phase, the output voltage will be modified close to this setting value.

13.9.4 Max AC voltage increase with battery voltage {1560}

This parameter allows you to set the maximum increase of the AC-Out voltage if the previous function is activated.

A : {1560}

B : Voltage of the ongoing charging cycle (bulk, absorption, equalisation, floating...)

C : 0.5V for 12V
1V for 24V
2V for 48V

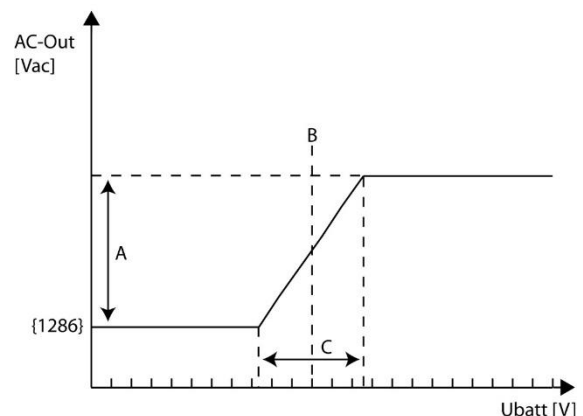

The main application of this function is the active loads control. It exists on the market voltage regulated loads that allow the intelligent consumption of the energy in excess (dump loads).



We recommend to use an initial voltage of 220 Vac and not 230 Vac {1286} This allows to avoid a too high output voltage (for instance 240 Vac) when the function is active.

13.9.5 Inverter frequency {1112}

This setting allows you to alter the output frequency of the inverter of the Xtender. This setting changes the limit frequencies on the charger's synchronization.



If you change the frequency from 50 to 60 Hz, the standard synchronization frequencies change from 45-65 to 55-75 Hz {1505}{1506}.

13.9.6 Inverter frequency increase when battery full {1536}

This function allows you to increase the inverter frequency when the battery is fully charged. The frequency variation is being carried out by index and non linear (frequency shift).

A : Voltage of the ongoing charging cycle (bulk, absorption, equalisation, floating...)

B : Floating voltage {1140}



C : 0.5V for 12V

1V for 24V

2V for 48V

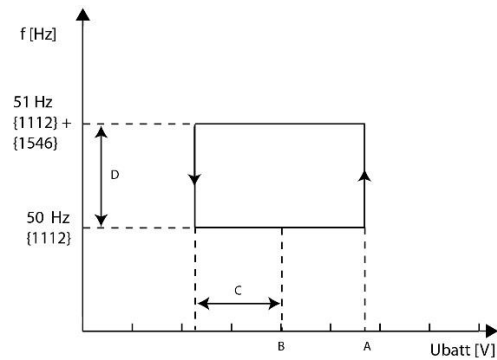
D: Max frequency increase {1546}



	If you use this parameter with parameter {1549}, you will have the two corrections stacked over one another.
	The main application of this parameter is the automatic control of a grid inverter connected to the Xtender output. When the batteries are not fully charged, the grid inverter charges them through the Xtender. Once the batteries are charged, the Xtender modifies the output frequency and the grid inverter stops automatically.

	The grid inverter must be compatible with this solution (grid feeding cut if the frequency is too high). If the grid inverter does not cut it may lead to a batteries overload and their definitive damaging.
---	--

	The grid inverter power must not exceed either the Xtender nominal power or the maximum power charge of the batteries; otherwise, it will lead to irreversible damages to them.
---	---

13.9.7 Inverter frequency increase according to battery voltage {1549}

If you activate this parameter, the output frequency in inverter mode will vary in proportion to the battery voltage. The function is depending on the batteries charge cycle and uses the reference voltage of the current cycle.

The basic frequency is increased up to the maximum value of parameter {1546}.

A : Maximum increase of the frequency {1546}

B : Battery cycle voltage reference

C : 0.5V for 12V

1V for 24V

2V for 48V

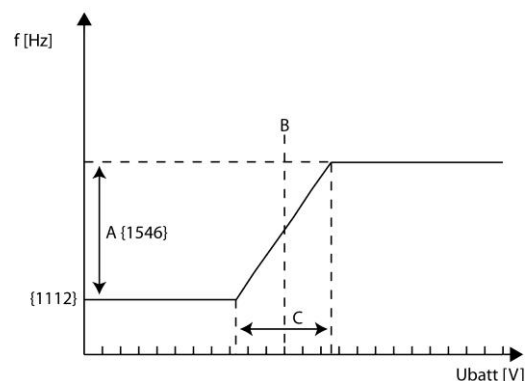

For instance if the battery carries out an absorption, the output frequency will be modified around this setting value. If the battery is in floating phase, the output frequency will be modified around this setting value.



If you use this parameter with parameter {1536}, you will have the two corrections stacked over one another.

13.9.8 Max frequency increase {1546}

This parameter determines how much the basic frequency is increased when a frequency variation is wished.

13.9.9 Speed of voltage or frequency change in function of battery {1534}

This parameter allows to modify the speed of the change of the frequency (df/dt) activated by {1549} and of the output voltage activated by {1548}. This is to best match the various brands of grid inverters when it comes to AC-coupling. They don't all have the same behaviour. There are 8 speed possibilities:

3:	8x	speed by default
2:	4x	speed by default
1:	2x	speed by default
0:		speed by default
-1:	1/2	speed by default
-2:	1/4	speed by default
-3:	1/8	speed by default
-4:	1/16	speed by default

13.9.10 Standby and turn on {1420}

13.9.10.1 Standby level {1187}

The standby function allows energy to be saved if there is no consumer present at the inverter output. In this case, the inverter disconnects its output and periodically emits a load search pulse. If a consumer is detected, it goes back into operational mode while measuring the power supplied and returns to standby if the consumer is deactivated.

This configuration allows adjustment of the power output at which the inverter goes into standby mode.

Proceed as follows to adjust this configuration:

Make sure that the inverter mode is active (no voltage present at the AC-In input). The input voltage is 0 and the input relay is indicated as open in real time on the information screen.

Increase the standby level value {1187} to the maximum

Activate the smallest consumer that can be detected and ensure that all the others are deactivated. Wait for the inverter to pass to standby, and the consumer then engages intermittently around once a second.

Progressively reduce the standby level value {1187} until the consumer runs permanently. If the consumer works for several seconds then stops, decrease the value of the standby level again.

An adjustment value between 0 and 100 is displayed. The value 100 represents the minimum sensitivity (biggest consumer detected).



If you would like to deactivate the standby function, it is sufficient to adjust the detection level to 0. In this case, the Xtender remains permanently activated if it is working in inverter mode.

13.9.10.2 Time delay between standby pulses {1189}

This setting allows you to determine the interval between the standby pulses.

13.9.10.3 Standby number of pulses {1188}

This setting determines the number of periods which are generated at the time of the standby burst.



Certain loads which are very difficult to detect may activate the inverter if the burst is longer than the only period normally used. In certain very particular cases, the standby is used to supply very small consumers. Prolonging the search burst allows you to correctly supply these consumers without the risk of losing the supply during the waiting period between the pulses.

13.9.10.4 Softstart duration {1599}

Once the inverter is switched on, the output voltage is progressively raised. This parameter sets the duration that is necessary to reach the nominal voltage.

13.9.11 Solsafe presence, Energy source at AC-Out side {1438}

This parameter allows the connection on the AC-Out side of an inverter for grid feeding. It also authorizes the Xtender to accept the energy coming from the output and to use it to charge the batteries.

13.10 AC-IN AND TRANSFER {1197}

These configurations manage the combined functions between the charger and inverter. The conditions for passing from one function to another are adjusted in this category.

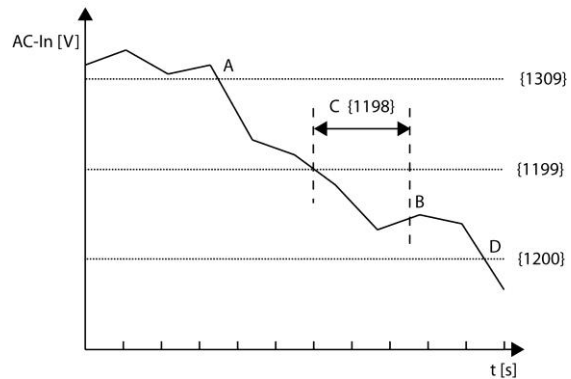

- A. Stoppage of charger operation {1309}
- B. Disconnection of transfer subject to delay {1199}
- C. Delay before opening of the transfer {1198}
- D. Immediate passage to the inverter threshold {1200}

13.10.1 Transfer relay allowed {1128}

The transfer relay is authorized or not. If the transfer is not authorized, a correct voltage at the AC-In input will not be transferred to the output and to the users. The battery charger function is not possible and the Xtender operates only in inverter mode.

Where there is lock on the inverter, charger or transfer function, a small padlock is displayed on the configuration display.

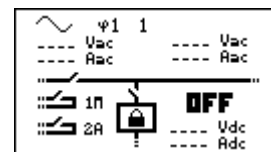

13.10.2 Delay before closing transfer relay {1580}

This parameter enables to delay the closing of the transfer relay even if the AC-In voltage is present.



This function can be useful while working with gensets having a pre-warming delay.

13.10.3 Smart-Boost allowed {1126}

The function Smart-Boost enables to add the power from the batteries to the one supplied by source connected to the AC-In when the user load is higher than that, set by the parameter {1107}, as a maximum input. This function is active by default.



When the Smart-Boost function is active, the batteries can be discharged even if a source is present at the input of the Xtender and the charger is active.

13.10.4 INSTALLER - Limitation of the power Boost {1607}

This function limits the power that the smart-boost function provides the backup source. The entered value represents the maximal power delivered in regards to the inverter's P30 power.

13.10.5 Maximum current of AC source (Input limit) {1107}

Adjust this configuration in the event of connection to a limited power source, for example, a generator of moderate power output or a dock or camping connection. The adjustment of this value limits the instantaneous power consumed from the source in charger mode. The power available is attributed by first priority to consumers and then to battery charging. If the consumption level changes, the battery charge current is automatically adjusted.

- A. Power available and used to recharge the batteries
- B. Maximum AC source current (adjusted to 10 A here)
- C. Consumer current
- D. Power supplied by the inverter (Smart-Boost function)

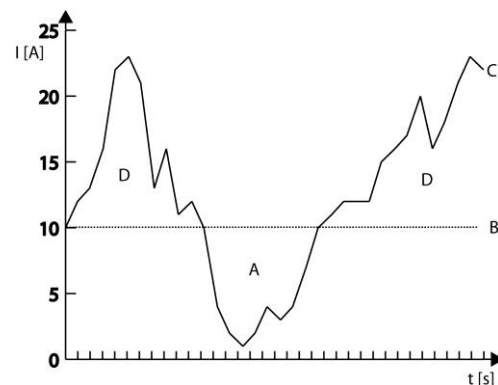

If the consumption level is higher than the controlled level, the maximum source current will be exceeded, except when the Smart-Boost function is activated.



It's possible to access faster to this function, please refer to the page 14

13.10.6 Max input current modification {1471}

With this sub-menu you can adjust the value of the AC current taken from the source, according to various external parameters:

13.10.6.1 Using a secondary value for the maximum current of the AC source {1566}

If this parameter is activated the value set for the maximum current of the source is inverted with the value programmed by the parameter below, when the command entry is activated.

13.10.6.2 Second maximum current of the AC source (Input limit) {1567}

Value used instead of the main value when the command entry is activated.



Use this function if you connect regularly two different sources like a generator and a shore power. By using this function, you can change from one input limit to another by means of an information contact on the command entry. Without having to program the maximum value at each change of source.

13.10.6.3 Decrease max. input limit current with AC-In voltage {1527}

This parameter forces the adaptation of the max. current of the source to the AC-In voltage. In case of sources with limited power (like a generator) the presence of big consumers at the output can generate a voltage drop. The setting of this parameter will help diminishing the current taken from the source in order to stabilize somehow the voltage.



When the Smart-Boost function is activated both the battery charge current and the Xtender power assistance are adapted.

13.10.6.4 Decrease of the max. current of the source with input voltage activated by command entry {1554}

This parameter activates the function "Decrease of the source max. current with the input voltage" {1527} but only when the command entry is activated too.



Usefull in cases where a second source must be stabilized by means of this function but not the first source, like for instance the public grid and a generator (joint use with {1566} and {1567}).

13.10.6.5 AC input low limit voltage to allow charger function {1309}

This parameter sets the voltage threshold where the input maximum current is lowered down to zero when the parameter {1527} is activated.

13.10.6.6 Adaptation range of the input current according to the input voltage {1433}

This parameter allows setting the input voltage range where the input current adjustment will be applied.

13.10.6.7 Charge current decrease coef. at voltage limit to turn back in inverter mode {1295}

When the AC-In voltage diminishes, the input current is automatically and proportionnally decreased. With this parameter you determine the factor of decrease to the full cut point:

- A : Minimum voltage to authorize the charger {1309}
- B : Start of the decrease of the charge current = Charger stop {1309} + {1433}
- C : Factor of decrease of the current {1295}

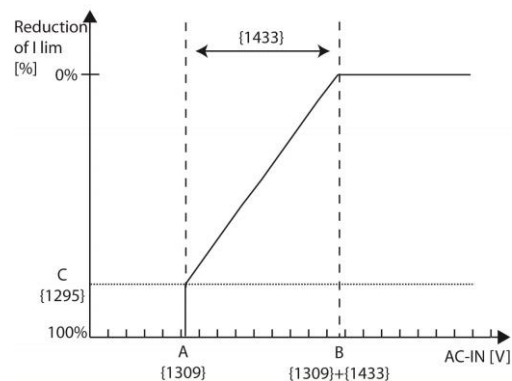

This parameter is particularly useful when the energy source is a generator. The current can be adjusted to take into account the generator voltage fluctuations in order not to overcharge it.

13.10.7 Overrun AC source current limit without opening the transfer relay (Input limit) {1436}

The parameter {1107} allows you to adapt the running of the Xtender to the maximum power of the source. In case this value is overrun, the transfer relay is not open and the circuit breaker on the

source side may go on default. With this parameter you can force the transfer relay to open itself and the Xtender to work in inverter mode.



Use this function if you have available a source that is smaller than the Xtender and if you don't use the function Smart-Boost. In this way, in case of overload of the source, all the power is supplied by the Xtender, up to its own limits.

13.10.8 Type of detection of the grid loss (AC-In) {1552}

The absence of input voltage (AC-In) opens the transfer relay and the inverter is activated. This detection works at three possible speeds.

The function "slow" suits small generators especially well but may create microcuts on the grid at the output (AC-Out) during commutation. This function will let some fluctuation of the input voltage and frequency before reacting.

The function "fast" is well adapted for sensitive loads that require few or no cuts during work.

The function "tolerant" lies in between and its sensitiveness can be set with the parameter {1510}. This way it is generally also possible to use small generators with loads sensitive to microcuts.

13.10.9 Tolerance on detection of AC-input loss (tolerant UPS mode) {1510}

With this parameter it is possible to set the sensitivity to detecting microcuts at the Xtender input (AC-In). A sensitivity of 60 indicates that the transfer opens by a cut equal or higher than 5ms, whereas a setting on 1 will lead the transfer to open from a cut of 80us.

13.10.10 Input voltage giving an opening of the transfer relay with delay {1199}

This configuration determines the voltage below which the transfer relay will open after a certain period of time. The Xtender will then run in inverter mode. The connection voltage is set automatically at 10V over this threshold. This hysteresis allows to avoid repeated commutations when the grid voltage is close to this threshold.

13.10.11 Time delay before opening of transfer relay {1198}

When the input voltage is below the transfer voltage to the inverter, the transfer relay does not open immediately. With this configuration, the period during which the transfer remains drawn can be specified. After this duration, the transfer relay is opened and the inverter function is activated (if the function has not been blocked or deactivated).



This delay is particularly useful on less stable grids or with generators with an output voltage that varies considerably during the activation of heavy loads.

13.10.12 Input voltage giving an immediate opening of the transfer relay (UPS) {1200}

Use the adjustment of this configuration to adjust the critical voltage for the operation of equipment that must not experience interruptions. In the case of a fluctuating grid, if its voltage passes below the value of the configuration this immediately activates the inverter function, thereby ensuring supply to the consumers.

13.10.13 INSTALLER – Absolute max limit for input voltage {1432}

This parameter is set to define the max. threshold of the input voltage AC-In. In case of an input voltage higher than this threshold during 1 period (20 ms at 50 Hz), the transfer relay will be open.

13.10.14 Delta frequency allowed above the standard input frequency {1505}

This setting allows you to determine the upper limit of the accepted frequency. This value is added to parameter {1112}, the output frequency of the inverter. If the frequency of the source exceeds this value, the transfer relay is opened after the duration determined by the setting {1507}.

13.10.15 Delta frequency allowed under the standard input frequency {1506}

This setting allows you to determine the lower limit of the accepted frequency. This value is subtracted from parameter {1112}, the output frequency of the inverter. If the frequency of the source is lower than this value, the transfer relay is opened after the duration determined by this setting {1507}.

13.10.16 Duration with frequency error before opening the transfer {1507}

If the input frequency is not included among the values determined by the settings above, the transfer relay is deactivated after the duration determined by this setting.

13.10.17 AC-In current active filtering {1575}

When this parameter is activated, the current taken on AC-Input is a sinusoid in phase with voltage. That mean only active power is taken from the generator. The inverter compensates harmonics and reactive current from the source.

This function also avoids fast speed change on the generator due to loads jumps.



For the filtering to work, it is also necessary to activate the Smart-Boost function {1126} and to authorize the charger {1125}.



This function is not possible with Xtender in parallel. Single units, dual or three phase with only one Xtender per phase are allowed and functional.



The maximal power of the active filter is equal to the Pnom power of the Xtender.

13.10.18 INSTALLER - Use an energy quota on AC-input {1557}

When this function is activated and the daily quota is reached, the charger and the boost are deactivated.

13.10.19 INSTALLER - AC-In energy quota {1559}

This value defines the quota of daily energy can be used on the AC-In. Exceeding the set value will generate a message and deactivate the charger and the Smart-Boost.

13.11 AUXILIARY CONTACTS 1 AND 2 {1201} {1310}

The Xtender inverter/charger is equipped with two auxiliary relays each with potential free contacts (reverser). These two relays allow multiple functions to be carried out by using adequate cabling as well as simple programming.

The programming of each contact is carried out independently except when conditions require the use of two relays. In this case, the programmed event for activating the second relay is automatically deactivated.

The extended functions of the auxiliary contacts are described directly after the chapter on simple functions.

The auxiliary contacts are activated immediately in response to the programmed signals. When the activation conditions are no longer fulfilled, they are deactivated with a delay of 2 seconds to avoid overswitching.

The auxiliary contacts respond to various signal types presented graphically below.

The following types of basic events may activate the contacts:

- Simple event
- Scheduled event
- Level

In the following description, each parameter has two reference numbers. The reference on the left relates to auxiliary contact 1 and the reference on the right to auxiliary contact 2 ({reference of the auxiliary contact 1} {reference of the auxiliary contact2}).

i The auxiliary contacts are factory set with pre-defined functions. If you wish to implement a specific function you must clear the programming already set. Use for that purpose the parameter {1569} or {1570}.

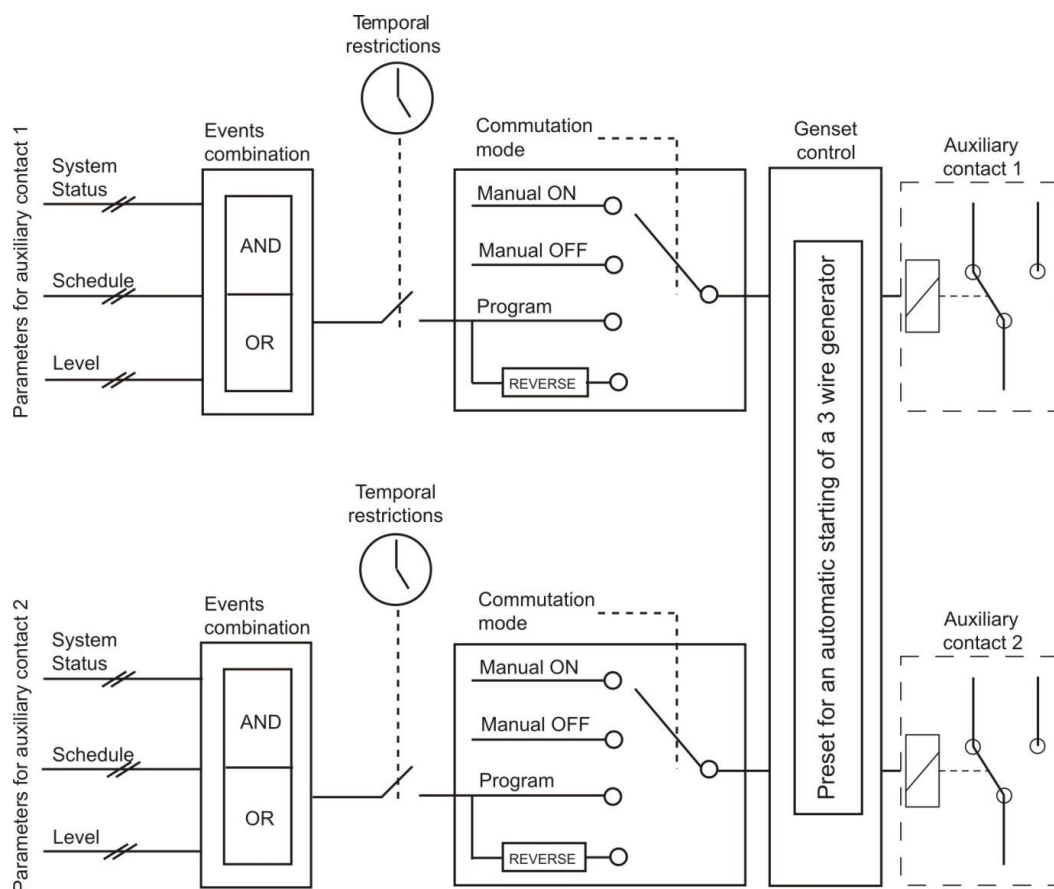

13.11.1 Operating mode {1202} {1311}

The auxiliary contacts may be controlled in 4 different ways:

Manual ON: In this mode, the contact is permanently drawn whatever the external conditions or programming

Manual OFF: In this mode, the contact is permanently released whatever the external conditions or programming

Automatic: In this mode, the auxiliary contact is activated according to the conditions and restrictions of its programming.

Reversed automatic: In this mode, the conditions and restrictions define the release of the contact.

13.11.2 Combination of the events for the auxiliary contact {1497} {1498}

This configuration defines how the various events intended to activate the auxiliary contact are combined.

Either a single event suffices to activate the contact (OR function) or it must have all the active events in order for the contact to be activated (AND function).

13.11.3 Temporal restrictions {1203} {1312}

These configurations allow the time frame to be defined in which the contact should under no circumstances be activated. Three distinct schedules are accessible in the form of restriction programs (programs 1 to 3). For each program, it is possible to select the day of the week where the restriction is activated. If the day is selected it appears on the screen and if it is not selected it is represented on the screen by two horizontal lines.

Once the days are selected, it is necessary to adjust the time frame where the restriction is active using the "starting time" and "finishing time" configurations. If the finishing time is programmed before the starting time, the restriction time frame is not taken into account. Below are the configurations with their references:

Program 1 {1204} {1313}

Day of the week {1205} {1314}

Start hour {1206} {1315}

End hour {1207} {1316}

Program 2 {1208} {1317}

Day of the week {1209} {1318}

Start hour {1210} {1319}

End hour {1211} {1320}

Program 3 {1212} {1321}

Day of the week {1213} {1322}

Start hour {1214} {1323}

End hour {1215} {1324}

INSTALLER - Program 4 {1216} {1325}

Day of the week {1217} {1326}

Start hour {1218} {1327}

End hour {1219} {1328}

Program 5 {1220} {1329}

Day of the week {1221} {1330}

Start hour {1222} {1331}

End hour {1223} {1332}



If your installer has made additional adjustments, it is possible that the restrictions could be active even if they do not appear in one of the three programs available to you.

13.11.4 Contact active with a fixed time schedule {1269} {1378}

The auxiliary contact can also be activated like a programmable clock. Three different weekly programs are available.

For each program, the time frame may be applied to one or several days of the week.

If the finishing time is programmed before the starting time, the time frame is not taken into account.

Program 1 {1270} {1379}

Day of the week {1271} {1380}

Start hour {1272} {1381}

End hour {1273} {1382}

Program 2 {1274} {1383}

Day of the week {1275} {1384}

Start hour {1276} {1385}
 End hour {1277} {1386}
 Program 3 {1278} {1387}
 Day of the week {1279} {1388}
 Start hour {1280} {1389}
 End hour {1281} {1390}

13.11.5 Contact active on event {1455} {1456}

The auxiliary contacts may be activated by the states or events occurring in the installation. Each event may be combined with another to establish complex functions.

13.11.5.1 Xtender is OFF {1225} {1333}

The contact is activated if the Xtender inverter/charger is switched off, either following a fault or manually.

13.11.5.2 Xtender ON {1518} {1519}

The auxiliary contact is activated if the Xtender inverter/charger is switched on.

13.11.5.3 Remote entry {1543} {1544}

The auxiliary contact is activated if the Remote ON/OFF input is active.

13.11.5.4 Battery undervoltage alarm {1226} {1334}

If the undervoltage threshold is reached, this activates the contact. In contrast to the acoustic alarm that is deactivated after a set time, this signal remains active as long as the battery voltage is below the threshold. If the undervoltage fault cuts in, this condition remains active as does the contact.

13.11.5.5 Battery overvoltage {1227} {1335}

Activates the contact in the event of battery overvoltage.

13.11.5.6 Inverter overload {1228} {1336}

Activates the contact in the event of an error due to excessive power in the inverter. In the event that the inverter disconnects due to excess power and it is attempting to restart, the contact is not activated until the end of the attempts.

13.11.5.7 Overtemperature {1229} {1337}

Activates the contact in the event of overtemperature in the electronics or the transformer.

13.11.5.8 No overtemperature {1520} {1521}

Activates the auxiliary contact if no overtemperature alarm is active.

13.11.5.9 Active charger {1231} {1339}

Activates the auxiliary contact if the charger function is active. When the Smart-Boost function is operating, the condition for activating the contact is not fulfilled.

13.11.5.10 Active inverter {1232} {1340}

Activates the auxiliary contact if the inverter function is active.

13.11.5.11 Active Smart-Boost {1233} {1341}

Activates the auxiliary contact if the Smart-Boost function is active. For more information on the Smart-Boost function, refer to the manual for the Xtender inverter/charger.

13.11.5.12 AC input presence but with fault {1234} {1342}

Activates the auxiliary contact if there is voltage present at the AC-In input but this voltage does not fulfil the conditions for activating the transfer relay.

13.11.5.13 AC input presence {1235} {1343}

Activates the auxiliary contact if a voltage is present at the AC-In input. This condition is independent of the state of the transfer relay.

13.11.5.14 Transfer relay ON {1236} {1344}

Activates the auxiliary contact if the transfer relay is drawn.

13.11.5.15 AC out presence {1237} {1345}

Activates the auxiliary contact if a voltage is present at the output of the Xtender inverter/charger.

13.11.5.16 Bulk charge phase {1238} {1346}

Activate the auxiliary contact if the battery is in bulk charge phase.

13.11.5.17 Absorption phase {1239} {1347}

Activates the auxiliary contact if the battery is in absorption phase. If the periodic extended absorption function is activated, the contact is also activated in this phase.

13.11.5.18 Equalization phase {1240} {1348}

Activates the auxiliary contact if the battery is in equalization phase.

13.11.5.19 Floating {1242} {1350}

Activates the auxiliary contact if the battery is in maintenance phase. If the extended reduced floating function is activated, the contact is also activated in this phase.

13.11.5.20 Reduced floating {1243} {1351} and

13.11.5.21 Periodic absorption {1244} {1352}

You can activate the auxiliary contacts on the reduced floating phase and the periodic absorption phase.

13.11.5.22 INSTALLER - AC-In energy quota {1601} {1602}

When the minigrad mode is activated and the AC-In energy quota is reached, the corresponding auxiliary relay is activated.

13.11.6 Contact active according to battery voltage {1245} {1353}

These configurations allow activation of the auxiliary contacts if the battery voltage passes below a selected voltage during a period that is configurable as well. Three voltages linked to three durations are configurable to activate the auxiliary contact.

The auxiliary contact will only be activated after the battery exceeds again a certain voltage value and also after a duration, both independently of the activation parameters.

This voltage and this duration are programmable too.

- Use dynamic compensation of battery level {1288} {1354}
- Battery voltage 1 activate {1246} {1355}
- Battery voltage 1 {1247} {1356}
- Delay 1 {1248} {1357}
- Battery voltage 2 activate {1249} {1358}
- Battery voltage 2 {1250} {1359}

- Delay 2 {1251} {1360}
- Battery voltage 3 activate {1252} {1361}
- Battery voltage 3 {1253} {1362}
- Delay 3 {1254} {1363}
- Battery voltage to deactivate {1255} {1364}
- Delay to deactivate {1256} {1365}
- Deactivate if battery is in floating phase {1516} {1517}



The threshold for opening the relay {1255} {1364}, for AUX1 and AUX2 respectively, work with a temperature compensation that cannot be deactivated.

13.11.6.1 Use dynamic compensation of battery level {1288} {1354}

If the contacts are activated according to the battery voltage, you can use the voltage dynamically compensated for each threshold.

If this function is not activated, the average battery voltage will be used.

If this function is activated, the real battery voltage is compensated according the power used.

13.11.6.2 Deactivate if battery in floating phase {1516} {1517}

If you activate one of the auxiliary contacts according to the battery voltage, you can force the deactivation if the battery is in floating mode. In this way, even if the deactivation voltage is not reached or if the duration of the voltage deactivation is not completed, the auxiliary contact will be released.

13.11.7 Contact active with inverter power or Smart-Boost {1257} {1366}

If the power output of the inverter exceeds a certain level, the contact may be activated. The excess is linked to a duration. Three power levels linked to three durations are configurable to activate the auxiliary contact.

The auxiliary contact will only be activated after the output power passes below a value and over a duration, both independently of the activation configurations.

If the Smart-Boost function is active, these configurations are also taken into account with the power of the boost.

- Inverter power level 1 activate {1258} {1367}
- Power level 1 {1259} {1368}
- Time delay 1 {1260} {1369}
- Inverter power level 2 activate {1261} {1370}
- Power level 2 {1262} {1371}
- Time delay 2 {1263} {1372}
- Inverter power level 3 activate {1264} {1373}
- Power level 3 {1265} {1374}
- Time delay 3 {1266} {1375}
- Inverter power level to deactivate {1267} {1376}
- Time delay to deactivate {1268} {1377}

13.11.8 INSTALLER - Contact active according to battery temperature {1503} {1504}

You can activate an auxiliary contact according to the battery temperature. This function is available with the temperature sensor BTS-01 or with the battery monitor BSP. Two distinct thresholds allow to switch ON and OFF the contact at different temperatures.

- Contact activated with the temperature of battery {1446} {1457}
- Contact activated over {1447} {1458}
- Contact deactivated below {1448} {1459}

13.11.9 Contact active according to SOC {1501} {1502} (only with BSP)

You can activate the auxiliary contacts according to the battery state of charge. If the battery state of charge goes below a given threshold, the contact will be activated. A duration can be linked to the threshold, which means that the battery state of charge must be below this threshold within the chosen duration, before the contact is activated.

The contact is deactivated when the battery state of charge goes again below a specific threshold that can be also linked to a duration.

The contact can also be deactivated when the battery reaches the floating phase.

- Contact activated with the SOC 1 of battery {1439} {1442}
- Contact activated below SOC 1 {1440} {1443}
- Delay 1 {1581} {1590}
- Contact activated with the SOC 2 of battery {1582} {1591}
- Contact activated below SOC 2 {1583} {1592}
- Delay 2 {1584} {1593}
- Contact activated with the SOC 3 of battery {1585} {1594}
- Contact activated below SOC 3 {1586} {1595}
- Delay 3 {1587} {1596}
- Contact deactivated over SOC {1441} {1444}
- Delay to deactivate {1588} {1597}
- Deactivate if battery in floating phase {1589} {1598}

13.11.10 Security, maximum time of contact {1512} {1513}



Caution :

If the maximum duration for the relay activation that you have selected is reached and if the activation conditions are still present (for instance a battery undervoltage), **the contact will not be reactivated as long as the conditions are present**. Therefore there is a risk that the auxiliary contact remains locked in this deactivated state and you will have to reset manually this alarm by deactivating and then activating this parameter. Use this function with care and only as a security.

13.11.11 Maximum time of operation of contact {1514} {1515}

When the conditions are met, either one or two relays are activated permanently. If you wish that the activation duration is limited in time, even if the conditions are met, you can activate this function. Once the relay is activated, a countdown runs according to the duration you have selected. Once this countdown is completed the relay is released, even if the conditions are still there. The relay cannot be activated anymore as long as the activation conditions have not disappeared.

13.11.12 Reset all settings {1569} {1570}

This function serves to reset all previous settings done on the corresponding auxiliary contact. Once this operation done, the auxiliary contact is not activated anymore.

Caution: this function cannot be cancelled.



Use this function before programming any function for an auxiliary contact. By doing this way you are sure that you begin with no unexpected setting who can activate the contact.

13.12 AUXILIARY CONTACTS 1 AND 2 EXTENDED FUNCTIONS {1489}

13.12.1 Generator startup

The two contacts may be combined in order to automatically start up a generator equipped with an electric starter. In this case the two contacts are dedicated to this function.

Auxiliary contact 1 serves as an operational contact and auxiliary contact 2 as a startup contact.

The startup condition of the generator must be programmed with the configurations of auxiliary contact 1. The startup is carried out by first activating the operational contact and then activating the startup contact. The latter engages several times, if necessary, to start up the motor. If a voltage appears at the terminals of AC-In, the startup contact is released.

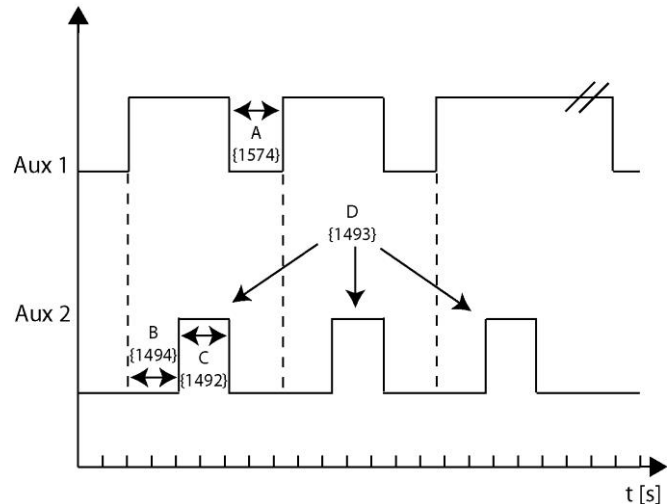

- A. Main contact hold/interrupt time {1574}
- B. Time before a starter pulse {1494}
- C. Starter pulse (with AUX2) {1492}
- D. Number of starting attempts {1493}

13.12.2 Generator control active {1491}

Activates the combination of the two auxiliary contacts for the generator start and the management of the start impulses.

13.12.3 Number of starting attempts {1493}

The start contact is activated a limited number of times in order to protect the starter if the generator has a fault. Once the maximum number of start has been reached, the operational contact is also deactivated. For a new attempt to be made the condition that generated the start must disappear and reappear.

13.12.4 Starter pulse duration (with AUX2) {1492}

With this configuration you can adjust the time at which the start contact is activated.

13.12.5 Time before a starter pulse {1494}

This configuration determines the duration between the start attempts. It also determines the duration between the activation of the operational contact and the first attempt at restarting.

13.12.6 Main contact hold/interrupt time {1574}

Some generators must have the main contact completely stopped between the cranking attempts (choke pulse). This parameter allows to set this duration.

13.13 SYSTEM {1101}

13.13.1 Remote entry (Remote ON/OFF) {1537}

The following parameters allow to customize the command entry.

13.13.1.1 Remote entry active {1545}

This parameter allows you to determine if the command entry is activated closed or open.

13.13.1.2 Prohibits transfer relay {1538}

If this parameter is activated, the command entry forbids the closing of the transfer relay.

13.13.1.3 Prohibits Inverter {1539}

If this parameter is activated, the command entry forbids the inverter function.

13.13.1.4 Prohibits charger {1540}

If this parameter is activated, the command entry forbids the battery charger function.

13.13.1.5 Prohibits Smart-Boost {1541}

If this parameter is activated, the command entry forbids the Smart-Boost function.

13.13.1.6 Prohibits grid feeding {1542}

This parameter forbids the grid feeding by means of the command entry.

13.13.1.7 Using a secondary value for the maximum current of the AC source {1566}

If this parameter is activated, the value set for the max current of the source is reversed with the value programmed by the parameter below.

13.13.1.8 Second maximum current of the AC source (Input limit) {1567}

Value used instead of the main value when the control entry is activated.



Use this function if you connect regularly two different sources like a genset and shore power. By using this function, you can go from one input limit to another without having to program the maximum value at each change of source.

13.13.1.9 Decrease of the max. current of the source with input voltage activated by command entry {1554}

This parameter activates the function "Decrease of the source max. current with the input voltage" {1527} but only when the command entry is activated too.



Usefull in cases where a second source must be stabilized by means of this function but not the first source, like for instance the public grid and a generator (joint use with {1566} and {1567}).

13.13.1.10 ON/OFF command {1576}

When this parameter is active, a pulse on the function input enables to put the Xtender ON or OFF. Max. duration of the pulse is 200ms.

13.13.1.11 Activated by AUX1 state {1578}

This parameter enables to put the auxiliary contact status back on the command entry. It is then possible, without cable, to use the auxiliary contact conditions to activate the command entry.

	Use for instance the programings of the auxiliary contact at fixed hour to alternatively forbid and authorize the charger according to the rate of the electricity from the grid.
---	---

13.13.1.12 Prohibits battery priority {1579}

If the battery is selected as priority energy source (see parameter {1296}), this priority can be operated with the control input and this parameter activated.

13.13.1.13 INSTALLER - Disable minigrid mode {1600}





This parameter allows deactivating the minigrid behaviour through command entry. It is particularly useful when a second energy source such as a generator is used to remove the frequency dependence.

13.13.1.14 INSTALLER - Prohibits charger using only power from AC-Out {1647}

This parameter prohibits the function of the charger using only current from AC-Out, described in parameter {1646}, by use of the remote entry.

13.13.2 Batteries priority as energy source {1296}

This parameter allows using in priority the energy stored in the battery even when an AC-In source is connected.

	Use this function for instance if you are connected to an external source of renewable energy which you want to use in priority.
	Attention, this function requires that the Smart-Boost function is activated (parameter {1126}) in order to function properly.
	This function is only active when the battery is in floating phase or in reduced floating phase.
	If the priority voltage is set higher than the floating voltage, the floating voltage will be used as set value.
	If an Xtender is coupled with a VarioTrack or VarioString charger with the battery as priority energy source, the charger's floating voltage should be slightly increased in order to maximize the available energy. (+1.2 V for 48V models, +0.6 V for 24V models and +0.3V for 12V models.

13.13.3 Battery priority voltage {1297}

When the function "battery as the priority energy source" is activated, the Xtender will authorize the battery discharge until this voltage. Below this voltage the charger is put back on order to avoid a deeper discharge of the battery.

13.13.4 Buzzer alarm duration {1565}

The duration of the Xtender acoustic alarm is defined with this parameter. By default the duration is 0 min and then no acoustic warning will occur when an error message appears. If an acoustic warning is needed, this value must be set to at least 1min.



The alarm responds to the following events: battery undervoltage, battery overvoltage, inverter overload and temperatures.

13.13.5 Auto restarts {1129}

In the event of an anomaly on the installation, the combi Xtender stops automatically. Depending on the seriousness of the fault, when this disappears, the Xtender may restart automatically without any user intervention (fault confirmation). The following functions allow the events for automatic restart to be defined.

After battery undervoltage {1130}

Number of batteries undervoltage allowed before definitive stop {1304}

Time period for batteries undervoltages counting {1404}

Number of batteries critical undervoltage allowed before definitive stop {1305}

Leadtime to counting the critical battery undervoltages allowed before final stop {1405}

After battery overvoltage {1131}

After inverter or Smart-Boost overload {1132}

Delay to restart after an overload {1533}

After overtemperature {1134}



Whatever the restart method, the event is recorded in the event history so that it can be called at any time.

13.13.5.1 **Number of batteries undervoltage allowed before definitive stop {1304} and Time period for batteries undervoltages counting {1404}**

If battery undervoltage faults occur to your system, the inverter and Smart-Boost functions are deactivated in order to protect the battery against deep discharges.

These functions can be reactivated automatically if the fault disappears. With the parameter {1304}, you can adjust the number of the faults before these functions are definitely deactivated. In this case, an intervention is necessary to reactivate these functions (fault acknowledgement).

The duration parameter allows setting the time during which these faults can be repeated.

Once this duration has come to an end, if the number of faults is not reached, the counter goes back to 0 and the faults can occur again.



To cancel the automatic reactivation, set 1 for the number of battery undervoltages allowed before final stop. For a permanent automatical reactivation, set 0.

13.13.5.2 **Number of batteries critical undervoltage allowed before definitive stop {1305} and Time period for critical batteries undervoltages counting {1405}**

The critical battery undervoltages can also be automatically acknowledged in case of undervoltage disappearance. Like for the undervoltages (see previous paragraph) you can adjust the number of restarts of the inverter and Smart-Boost functions once the fault disappears.

13.13.5.3 **Delay to restart after an overload {1533}**

If the function inverter is stopped after an overload (power of the users too high) the inverter will do one or several attempts to restart. You can use this parameter to determine the time between the restart attempts (in seconds).



This gives you more time to disconnect the users which caused the overload.

13.13.5.4 Autostart to the battery connection {1111}

When this setting is activated, the Xtender starts itself automatically when the battery is connected.



Note that in this case, the output of the AC-Out is immediately supplied, and a lethal voltage is present on its terminals.

13.13.6 System earthing (Earth - Neutral) {1484}

This menu allows you to determine the switching rules for the neutral and its connection to the ground in transfer relay operation (inverter mode or charger mode).

13.13.6.1 Prohibited ground relay {1485}

If you activate this setting (yes), there will be no connection between the neutral and the ground, whatever the mode of operation (inverter or charger).

If this setting is deactivated (no), the neutral is connected to the ground during operation in inverter mode and disconnected in charger mode, i.e. when the transfer relay is closed and the AC-In is connected to the AC-Out.

13.13.6.2 Continuous neutral {1486}

If this setting is activated, the neutral of the AC-Out remains connected to the neutral of the AC-In when the Xtender is operating in inverter mode.

13.13.7 INSTALLER – Watchdog control system {1628} and {1629}

These parameters make it possible to set a watchdog function for the Xtender, for use within a system controlled by an Xcom module. (The watchdog is a monitoring software that restarts the Xtender in case the communication is lost).

This system is active when the parameter {1628} (Xtender watchdog enable) is enabled and the parameter {1550} (parameters saved in flash memory) is disabled. Each time the CAN receives a parameter the counter, whose duration is set in seconds by parameter {1629}, will be restarted. If no parameter is received during this period of time the Xtender will stop and a RESET will take place. The device restarts in the configuration determined by the parameter settings before {1550} was set to "no".

In a multi-unit system, each Xtender will handle this function independently. Each device must therefore receive a parameter within the time-frame set by {1629}.

By default this level is deactivated and the time period is set to 60s, adjustable from 10s to 300s.

13.13.8 INSTALLER – Parameters saved in flash memory {1550}

This parameter allows you to determine if the parameters modified in your system must be saved or not. To save the lifetime of the flash memory in case of repeated writings, like in the case of communication between your system and an external SCADA system, this parameter must be deactivated (no). If the backup of parameters is deactivated, the applied parameters can't be shown.

13.13.9 Reset of all the inverters {1468}

This parameter allows you to restart all inverters.

13.14 MULTI XTENDER SYSTEM {1282}

This section allows setting the operating possibilities of systems with several Xtenders. Either parallel or 3-phase.

13.14.1 Integral mode {1283}

If you activate this parameter, the system will work in order to have either a 3-phase output, or no output voltage. For instance in case of one phase overload, if the integral mode is activated, the cut of this phase will lead to the cut of all phases.

13.14.2 Multi inverters allowed {1461}

This parameter allows to forbid the setting in parallel or in 3-phase of a system. If this parameter is deactivated and several Xtender are connected with the link cable, it will be impossible to put them on.

13.14.3 Multi inverters independents. Need reset {1468} {1462}

This setting allows you to use several Xtenders connected via the same communication bus, without using synchronization. The phase selection tabs are therefore not in operation. However, in order to display the user information, the RCC remote control uses this information (if two inverters are programmed on the same phase, they appear as if they are in parallel on the remote control).

13.14.4 Battery cycle synchronized by the master {1555}

When several inverters are connected to the same battery, it is preferable that they all have a battery cycle synchronized, to carry out for instance an equalizing at the same time. When this parameter is activated, the inverter master of the system imposes the ongoing battery cycle to the others. If several separated batteries are used, this parameter must be put on NO.

13.14.5 Allow slaves standby in multi-Xtender system {1547}

When several Xtenders are connected in parallel and the energy consumption is reduced, one single Xtender may be enough to cope with the needs. In that case, the others can be put in stand-by in order to save energy. This parameter allows you to authorize or not the stand-by of the secondary Xtenders.



As soon as the power reaches around 75% of the Xtender nominal power the others are activated.
The activation time is around 50ms.

13.14.6 Splitphase: L2 with 180 degrees phaseshift {1571}

Displaces the phase L2 by 180 degrees instead of standard three-phase systems 120 degrees. L2 is in reverse phase compared to L1.



This is about an electrical configuration mainly used in North and Central America. It is meant to obtain 240V with two inverters in reverse phase, while seeking 120V on each phase.

13.14.7 INSTALLER – Minigrid compatible {1437}

This parameter makes your inverter suitable to be integrated into a minigrid distributed system. For more information on minigrids, contact us on info@studer-innotec.com.

13.14.8 INSTALLER – Minigrid with shared battery energy {1577}

In a minigrid system, this parameter authorizes or not the inverter to share its energy with the rest of the system. For more information on minigrids, contact us on info@studer-innotec.com.

13.15 GRID-FEEDING {1522}

It is possible under some conditions to feed the grid with energy (AC-In). The following options allow you to control the different parameters involved.

13.15.1 Grid feeding allowed {1127}

This parameter allows to authorize or not the grid feeding. By default setting the grid-feeding is not authorized. In that case, no energy is sent back to the grid, whatever the operating mode of the Xtender. The basic grid-feeding function maintains the battery charged at the standard cycle voltage (absorption, floating, ...). If there is excess energy in the batteries then power is sent to the grid. Per example for an installation connected to a grid with battery full, if a solar charger connected to the battery raises the voltage, grid feeding is done to maintain voltage at the floating level.



The injected power corresponds to the power of the converter and will be divided between AC-In and AC-Out depending on the loads. Adding an output load will therefore reduce the amount of injected current to the grid.

13.15.2 Maximum grid feeding current {1523}

This parameter allows setting a limit for the grid-feeding current. Whatever the setting of this parameter, the maximum current of the source is respected {1107} (Input limit).

Frequency limit

The grid-feeding is reduced linearly when the frequency is above the nominal frequency of the inverter. Until the reference user frequency attains {1112} +1Hz the grid-feeding is maximal and at user frequency+2Hz the grid-feeding current is zero. In a 50Hz system, the grid-feeding is typically maximal at 51Hz or below, is half at 51.5Hz and zero at 52Hz and above.

This behaviour is used to be compatible with frequency shift power control in off-grid systems.

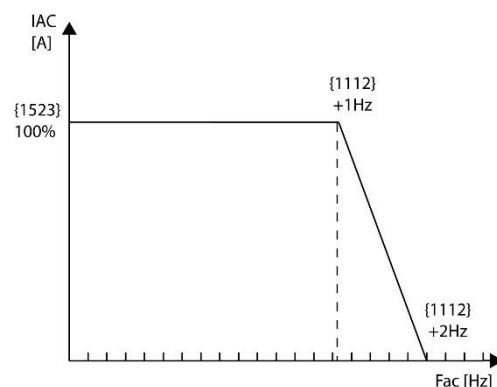

Voltage limit

Grid-injecting inverters have a protection that limits their power when the grid voltage is too high due to important impedance of the line.

If the voltage exceeds the user reference voltage defined by parameters {1286} and {1433}, the grid feeding current is reduced. The default values of these parameters are typically set to 230V {1286} and 10V {1433}. Thus the grid feeding is reduced when the voltage is over 240V.

If the grid is always at 250V the inverter will not inject at all according to the parameter {1286} and {1433}, that stops injecting over 230+10V.

INSTALLER



Whatever the setting of this parameter, the maximum current of the source is respected {1107} (Input limit).

13.15.3 Forced grid feeding {1524} {1525} {1526}

With the forced grid feeding, it is possible to discharge the batteries in the grid during a given time frame. The goal is to support a grid at during a given time of the day with stored energy. Between the start time {1525} and the stop time {1526} the batteries are discharge to the grid-feeding voltage target {1524}. The maximum grid-feeding current is always given by the {1523} parameter. If the start time and the stop time are the same, then the standard grid feeding is used and not the forced greed feeding (no discharge of the battery into the grid).

For instance, grid-feeding is allowed and forced between 19h00 and 20h00 at 24V. During the day, the batteries are charged and if there is excess solar energy, it is sent to the grid to maintain the floating voltage. At 19h00 the inverter starts to discharge the batteries in the grid at the given maximal current. It stops to discharge at 20h.



Be careful with the grid-feeding function. Always respect the rules in force prescribed by your utility. Grid feeding with inverters connected to batteries is forbidden in some countries. There is no ENS function or any other similar function linked with the grid-feeding function of the Xtender. You can add an external ENS detector.

13.15.4 INSTALLER - Use of the defined phase shift curve for injection {1610}

The directive VDE-AR-N 4105:2011 dictates a phase variation of the injected current in accordance with the power. If you wish to inject a current dephased from the voltage, you can use this function. If this function is activated the injection will be made according to the parameters below. You can determine the location of the second cos phi point (inflection point) in the curve below by using parameters {1613} and {1623}.

The grid injection parameters {1622, 1623 y 1624} should be configured to "capacitive" if the grid operator requests "overexcited" behaviour. The grid operator requests this when the grid has loads that are mostly inductive. In this case, the grid operator will see the injector as a capacitance (capacitor) that will help compensate the inductive loads on the grid.

The grid injection parameters {1622, 1623 y 1624} should be configured to "inductive" if the grid operator requests "under excited" behaviour. The grid operator requests this when the grid has loads that are mostly capacitive. In this case the grid operator will see the injector as an inductance (coil) that will help compensate the capacitive loads on the grid.

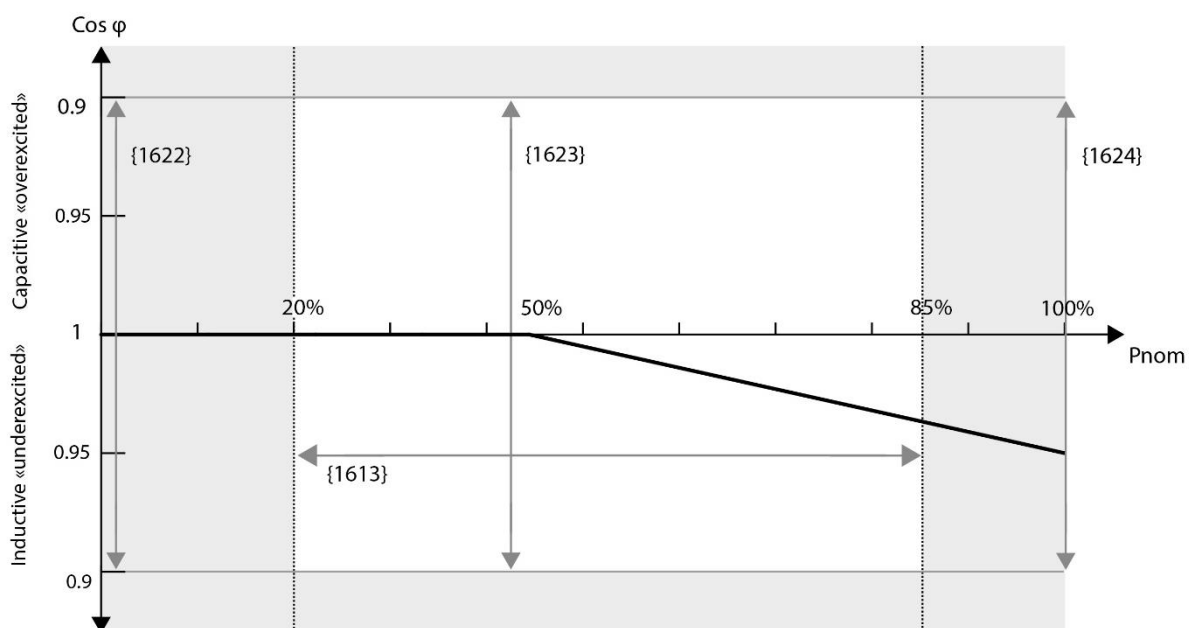

13.15.5 INSTALLER - Cos phi at P=0% {1622}

This parameter determines the phase of the current at minimal grid-feeding power (point to the far left on the curve). You can choose a value between an inductive cos phi of 0.9 to a capacitive cos phi of 0.9.

13.15.6 INSTALLER - Power of the second cos phi point in % of Pnom {1613}

This parameter determines at what power level, as a percentage of Pnom, the second cos phi point (inflection point) occurs in the curve of injected current.

13.15.7 INSTALLER - Cos phi at the power defined by param {1613}, {1623}

This parameter will let you determine the cos phi at the power defined by parameter {1613}. The Cos phi can be selected within the limits of 0.9 capacitive to 0.9 inductive.

13.15.8 INSTALLER - Cos phi at P=100% {1624}

With this parameter you can select the cos phi at maximal grid-feeding power (Pnom of the Xtender). The value can be chosen in between 0.9 capacitive and 0.9 inductive.

13.15.9 INSTALLER - ARN4105 frequency control enabled {1627}

Control maximum injection current as a function of frequency as defined by the curve specified in ARN4105. Once the frequency reaches {1112} + {1630}, the injection current is fixed at that instant. Then, the parameters {1630} and {1631} are applied. When the frequency reduces below 50.2 Hz, the injection current is increased by 10% each minute.

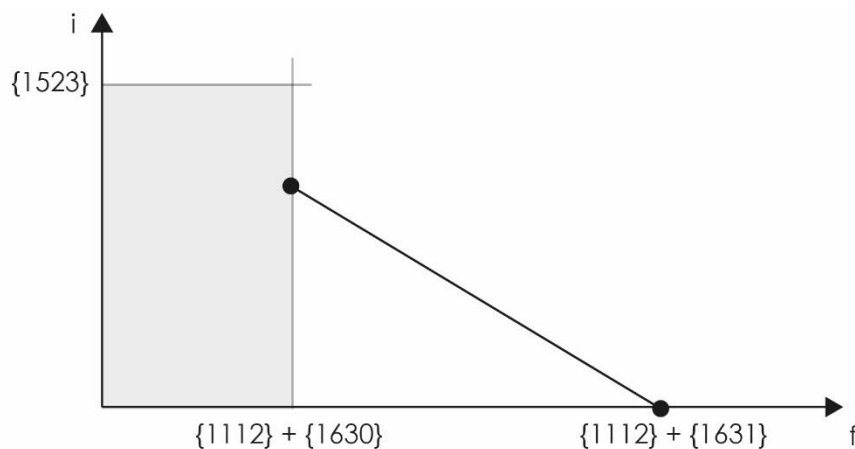

13.15.10 INSTALLER - Delta from user frequency to start derating {1630}

Delta above user frequency {1112} at which the injection current starts to be reduced.

13.15.11 INSTALLER - Delta from user frequency to reach 100% derating {1631}

Delta above user frequency at which the injection current is zero.

14 INFORMATION ON THE SYSTEM

The system information allows you to check the versions of the various elements of your installation.

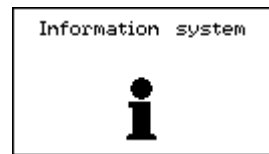

14.1 REMOTE CONTROLS

You will receive information on the hardware and software versions for each remote control. Furthermore, you have access to its unique ID number. This unique number is marked FID followed by its ID.

14.2 XTENDER

For each Xtender connected at the remote control, you can consult the following information: the hardware version of the motherboard itself as well as the powerboard, the software version of the Xtender program and the unique ID of the Xtender. This unique number is also marked FID and followed by its ID.

15 SOFTWARE UPDATES

The software of the remote control RCC as well as the softwares in the inverter/chargers of the Xtender range, the communication module RS-232 (Xcom-232i) and the battery monitor (BSP) can be updated in order to integrate all new functionalities.

For the remote control RCC itself it is also possible to integrate new display languages (max. 4 in each RCC). To learn more about the updating process or the additional languages available, contact your installer or go to www.studer-innotec.com/en/downloads/.

15.1 UPDATING PROCESS



Before inserting the SD card to carry out an updating, it is better to switch off all Xtenders (off). If you do not do it manually, the updating process will automatically stop all Xtenders connected to the remote control.

To carry out a software update, insert the SD card (containing the last update) into the slot of the remote control. Before proceeding with the software update, the system checks automatically the compatibility between the material and the software present on the card. The SD card must not be removed until the updating process is completed. If however the updating process was interrupted, insert the SD card again to let the process carry on.

The updating process takes 3 to 15 minutes depending on the number of devices connected to the communication bus.

Once the update is completed, the remote control displays one of the following messages:

- "(051) The update is finished" or
- "(052) Your installation is already updated" or
- "Error (050) : Incomplete data transfer"

In the last case, the updating process has not ended correctly. You must start it again from the beginning.

In the case of a change of language, the system restarts automatically with the new one as current language.



If the installation contains more than one remote control (RCC) or Xcom-232i, each remote control and each Xcom-232i must be updated separately.

16 APPLICATION EXAMPLES

The examples below illustrate some implementation options for current installations. Useful configurations for these situations are also given. These are common and non-obligatory configurations.

For more details on each configuration shown, please refer to the complete description given above in this manual.

16.1 GENERAL USE: INVERTER, CHARGER WITH GRID

Description:

In this configuration, the Xtender is connected to a grid with high power output. The basic functions are configured for this type of application. The loads are supplied by the grid via the transfer relay and this helps to charge the battery. In the event of a disconnection from the grid, the transfer is stopped and the inverter is activated automatically.

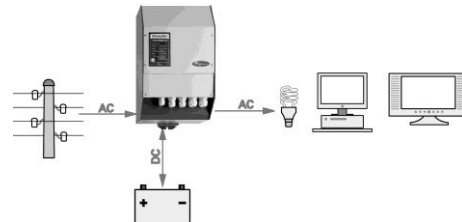

Associated current configurations:

Battery charge current {1138} Adapt this configuration to the technical data for the batteries for the best charging capacity.

Adjustment of the standby level {1187} Adjust this configuration if the minimum load has not been detected or, conversely, if the inverter remains engaged when all the loads have been deactivated.

Additional configurations:

Battery curve {1140} {1156} {1157} Adapt these configurations in order to adjust the voltage levels and the durations of charge to your battery manufacturer's data.

16.2 USE OF A LIMITED POWER SOURCE

Description:

For example, a source such as a generator, a camping or dock connection. In this case the power available is limited. In the case of high power consumers the source is insufficient and needs assistance by means of the energy stored in the batteries.

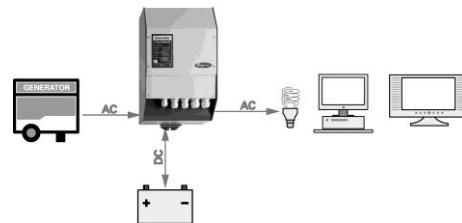

Associated current configurations:

Maximum current of the AC source {1107} By adjusting this configuration to the maximum current that the source can supply, the power available is ideally shared between the battery charging and the consumers. For example, if a load is deactivated, the battery charger current is automatically increased.

Locking: Smart-Boost allowed {1126} In the event that the maximum source current is exceeded, the inverter supplies the energy required to keep the source current at the set maximum level. Thus, the inopportune stopping of the generator is avoided, the circuit breaker of the dock or camping connection is not activated and the supply of the loads is assured.

Option of exceeding the maximum current of the source (Input limit) value without opening the transfer relay {1436}. Allows retention of the drawn transfer in the event of consumption of peak currents such as compressor startups.

16.3 USE TO INCREASE THE POWER ON AN EXISTING INSTALLATION

Description:

The availability of an inverter or an inverter/charger allows its power to be extended with an Xtender connected in cascade. The maximum power of the first inverter is limited by the maximum current from the transfer relay of the Xtender.

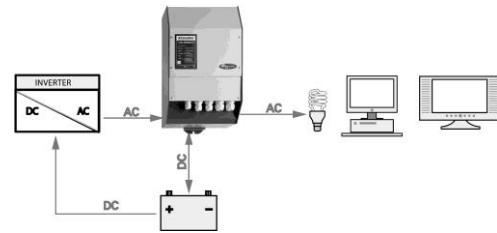

Associated current configurations:

Maximum current of the AC source {1107} Adjust this configuration in relation to the maximum current that can supply the old inverter.

Locking: Smart-Boost inactive {1126} Suppress the locking of this function: This way, when the first inverter has reached its maximum power, the power consumed that will be supplied by the Xtender could be increased.

Locking: Inactive charger {1125} This lock, without which the battery energy would be taken by the first inverter, is returned by the Xtender charger. This would only have the effect of discharging the battery with losses caused in the two inverters or inverter/chargers.

16.4 LOAD SHEDDING OF THE SECOND PRIORITY LOADS

Description:

Consumers with different supply priorities allow automatic disconnection of the supply to consumers of lower priority if the battery becomes weak. The supply of the priority loads is thus assured, such as lighting or computers, for example. In this case, the low-priority loads must be cabled via one of the auxiliary relays. The reference for the example below corresponds to the auxiliary contact no 1.

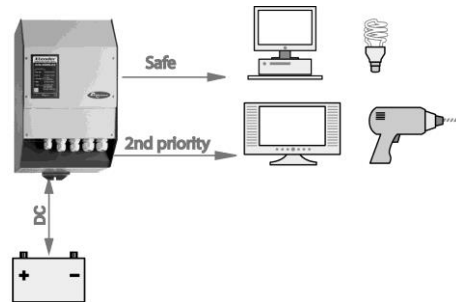

Associated current configurations:

Operating mode {1202}

Relay activated by the battery voltage {1245}

Battery voltage 1 activate {1246}

Battery voltage 1 {1247}

Delay 1 {1248}

Battery voltage to deactivate {1255}

Delay to deactivate {1256}

17 APPENDICES

17.1 APPENDIX 1: LIST OF CONFIGURATION INTERDEPENDENCIES

N°	Configuration	N°	Minimum limit by	N°	Maximum limit by
{1108}	Battery undervoltage level without load	{1109}	Battery undervoltage level at full load	{1110}	Restart voltage after batteries undervoltage
{1109}	Battery undervoltage level at full load			{1108}	Battery undervoltage level without load
{1110}	Reactivation voltage after battery undervoltage	{1108}	Battery undervoltage level without load		
{1121}	Battery overvoltage level	{1122}	Restart voltage level after an battery overvoltage		
{1122}	Restart voltage level after an battery overvoltage			{1121}	Battery overvoltage level
{1140}	Floating voltage			{1156}	Absorption voltage
{1156}	Absorption voltage	{1140}	Floating voltage		
{1164}	Equalization voltage	{1156}	Absorption voltage		
{1172}	Reduced floating voltage			{1140}	Floating voltage
{1174}	Periodic absorption voltage	{1172}	Reduced floating voltage		
{1195}	Max voltage for adaptive low voltage	{1108}	Battery undervoltage level without load		
{1199}	Input voltage giving an opening of the transfer relay with delay	{1200}	Input voltage giving an immediate opening of the transfer relay (UPS)		
{1200}	Input voltage giving an immediate opening of the transfer relay (UPS)			{1199}	Input voltage giving an opening of the transfer relay with delay

17.2 TROUBLE-SHOOTING

User ref.	Description	Troubleshoot
50	Error (050): Incomplete data transfer	Problem associated with the SD card. The code in parenthesis indicates the origin of the problem. From R514 (01.2013) a second message further describes the origin of the problem.
51	(051): The update is finished	Message displayed at the end of a software update that has been completed successfully.
52	(052): Your installation is already updated	When an SD card with a software update folder (02) is inserted, into an RCC or Xcom device, the version of the files on the SD card are compared to the version installed on each device. This message appears if all the devices have software versions that are the same or more recent than those on the SD card.
54	(054): Please wait. Data transfer in progress	Message displayed when data is being transferred (software update, save files, upload files, etc.). The user can not make the message disappear from the RCC screen. It disappears automatically when the process is finished. The activity of the RCC on the CAN bus is limited to the transfer of data while the message is displayed.
55	Error (055): No SD card inserted	HCC library. The SD card is not present when the device tries to access it; for example, when the daily logfile is saved to the SD card at midnight each day.
57	(057): Operation finished successfully	The operation related to the SD card has finished correctly (save, upload, etc.).
63	(063): Save parameter XT	Message not displayed that indicates a modification of a parameter. The value saved with the message is the parameter reference.
64	(064): Save parameter BSP	
65	(065): Save parameter VarioTrack	
74	(074): Save parameter Xcom-MS	
143	(143): Save parameter Xcom SMS	
144	(144): Save parameter VarioString	
71	Error (071): Insufficient disk space on SD card	The SD card is full, and some files must be deleted. When this message appears, the 30 oldest log files on the SD card are deleted automatically when the day's log file is saved to the SD card at midnight.
73	(073): Datalogger is enabled on this RCC	Message no longer used. With the previous version of the communication bus, only one RCC had the datalogger activated by default. That RCC was identified via this message.
85	Error (085): Modem not available	No response from modem. Check the RS-232 cable.

User ref.	Description	Troubleshoot
86	Error (086): Incorrect PIN code, unable to initiate the modem	Incorrect PIN code. Not possible to start the modem.
87	Error (087): Insufficient Signal from GSM modem	Signal test before connection.
88	Error (088): No connection to GSM network	The signal strength is sufficient, but the connection to the mobile network is not possible.
89	Error (089): No server access	Connection to the server is not possible for the Xcom-LAN or Xcom-GSM
90	(090): Server connected	Message indicating the proper connection to the server.
91	Error (091): Update software of other RCC or Xcom-232i	All RCC and Xcom-232i connected to the same communication bus should have the same software version. It is necessary to update each one individually with its SD or microSD card.
92	Error (092): More than 3 RCC or Xcom-232i in the system	The max number of devices of the same type has been surpassed.
93	Error (093): More than 1 BSP in the system	
94	Error (094): More than 1 Xcom MS in the system	
95	Error (095): More than 15 VarioTrack in the system	
141	Error (141): More than 1 Xcom SMS in the system	
142	Error (142): More than 15 VarioString in the system	
121	Error (121): Impossible communication with target device	Problem related to the exchange of files with a device that is not properly identified on the CAN communication bus. Check the connection of the CAN bus.
122	Error (122): SD card corrupted	Unrecoverable error on the SD card. A sector of the SD card has generated an error. File read error. File write error. The file system is unusable (too many errors when using the SD card).
123	Error (123): SD card not formatted	The SD card is not formatted. It can be re-formatted with a computer.
124	Error (124): SD card not compatible	The SD card is not compatible with the Studer system. See Xtender software update procedure for a description of the compatible SD card and formatting options.
125	Error (125): SD card format not recognized. Should be FAT	The type of FAT formatting of the SD card is not recognized. The data support is too small or too big for the required format type. The only size supported is 512 bytes.
126	Error (126): SD card write protected	The SD card is protected or locked.
127	Error (127): SD card, file(s) corrupted	The file header is corrupted. Checksum error. The f_read functions does not have all required data.

User ref.	Description	Troubleshoot
128	Error (128): SD card file or directory could not be found	The required file is not on the SD card.
129	Error (129): SD card has been prematurely removed	The SD card was removed before the data transfer finished.
130	Error (130): Update directory is empty	The update folder is empty.
134	(134): Reception level of the GSM signal	Indication of the GSM signal level in the Xcom-GSM
145	Error (145): SIM card blocked, PUK code required	SIM card blocked. PUK required. To unblock SIM card, a mobile phone should be used to enter the PUK.
146	Error (146): SIM card missing	Missing SIM card
148	(148): Datalogger function interrupted (SD card removed)	Since the SD card is not present, there will not be any datalogs saved to the SD card at midnight each day.
162	Error (162): Communication loss with RCC or Xcom232i	The device does is not communicating on the CAN bus. Check the communication cable and the connection to the battery of all devices.
163	Error (163): Communication loss with Xtender	
164	Error (164): Communication loss with BSP	
165	Error (165): Communication loss with Xcom MS	
166	Error (166): Communication loss with VarioTrack	
167	Error (167): Communication loss with VarioString	
172	Error (172): FID change impossible. More than one unit.	The change of FID is not possible since more than 1 device is connected to the RCC. In order to change the FID, the RCC should be connected to only 1 other device.
189	Error (189): Incompatible configuration file	The configuration file of the Xcom-SMS is too old. Download the new version of the XcomConfigurator.exe from the Studer website.
190	(190): The Xcom-SMS is busy	El Xcom-SMS is working on other data treatment.
191	(191): Parameter not supported	The command is not supported. Example: change the user level of a menu title.
192	(192): Unknown reference	The parameter or information reference does not exist.
193	(193): Invalid value	This value is impossible for this property
194	(194): Value too low	The value is below the minimum limit
195	(195): Value too high	The value is above the maximum limit
196	(196): Writing error	Write is possible, but failed.
197	(197): Reading error	Read is possible, but failed.
198	(198): User level insufficient	The parameter user level is higher than the access rights of the SCOM (only factory level parameters are not accessible by SCOM).

User ref.	Description	Troubleshoot
199	(199): No data for the report	The data necessary for the creation of an Xcom-SMS report are not ready (minimum of 2 minutes of data are needed after connecting system).
200	Error (200): Memory full	Not possible to add another telephone number for periodic reports or events.
202	Warning (202): External alarm arrives	The battery has activated a warning (problem occurred). The battery will continue to function when an alarm appears.
203	(203): External alarm leaves	The battery has deactivated a warning (problem solved).
204	Error (204): External stop arrives	The battery has activated an error (problem occurred). The battery stops working in the case of an error.
205	(205): External stop leaves	The battery has deactivated an error (problem solved). If there are not any more errors, the battery can re-start.
216	Warning (216): Scom watchdog caused the reset of Xcom-232i	Problem with SCOM protocol. See the technical description of the SCOM protocol, available on Studer website, for more information.
217	Warning (217): CAN problem at Xtender declaration	Problem with the Xtender announcing itself (old version of communication bus CAN1).
218	Warning (218): CAN problem while writing parameters	The system tried to write a parameter 3 times to a device and it did not work. Check the CAN communication bus.

18 PARAMETER TABLES

18.1 REMOTE CONTROL PARAMETERS

Level	User ref.	Parameter	Unit	12			24			48			Mod. value
				Factory	Min	Max	Factory	Min	Max	Factory	Min	Max	
Basic	5000	Language	English		-	-		-	-		-	-	
Expert	5036	OTHER LANGUAGES											
Basic	5038	Choice of the second language	Text	French	-	-	French	-	-	French	-	-	
Basic	5039	Choice of the third language	Text	German	-	-	German	-	-	German	-	-	
Basic	5040	Choice of the fourth language	Text	Spanish	-	-	Spanish	-	-	Spanish	-	-	
Basic	5001	Time		00:00	00:00	23:59	00:00	00:00	23:59	00:00	00:00	23:59	
Basic	5002	Date		0	-	-	0	-	-	0	-	-	
V.O.	5012	User level		16	-	-	16	-	-	16	-	-	
Expert	5019	Force remote control to user BASIC level		-	-	-	-	-	-	-	-	-	
Expert	5057	DATALOGGER											
Expert	5101	Datalogger enabled	Text	Automatic	-	-	Automatic	-	-	Automatic	-	-	
Expert	5059	Save today's datas		-	-	-	-	-	-	-	-	-	
Inst.	5109	Datalogger reset when modifying the installation	No/Yes	No	-	-	No	-	-	No	-	-	
Inst.	5120	Erase the 30 oldest log files from the SD card		-	-	-	-	-	-	-	-	-	
Expert	5123	Activation of R&D tracks	No/Yes	No	-	-	No	-	-	No	-	-	
Basic	5013	SAVE AND RESTORE FILES											
Basic	5041	Save all files (system backup)		-	-	-	-	-	-	-	-	-	
Basic	5068	Restore all files (system recovery)		-	-	-	-	-	-	-	-	-	
Basic	5070	Apply configuration files (masterfile)		-	-	-	-	-	-	-	-	-	
Expert	5032	Separator of the .csv files	Text	Automatic	-	-	Automatic	-	-	Automatic	-	-	
Expert	5069	Advanced backup functions											
Expert	5030	Save messages		-	-	-	-	-	-	-	-	-	
Expert	5049	Save and restore RCC files											
Expert	5015	Save RCC parameters		-	-	-	-	-	-	-	-	-	
Expert	5016	Load RCC parameters		-	-	-	-	-	-	-	-	-	
Inst.	5097	Create RCC configuration file (masterfile)		-	-	-	-	-	-	-	-	-	
Expert	5098	Load RCC configuration file (masterfile)		-	-	-	-	-	-	-	-	-	
Expert	5050	Save and restore Xtender files											
Expert	5017	Save Xtender parameters		-	-	-	-	-	-	-	-	-	
Expert	5018	Load Xtender parameters		-	-	-	-	-	-	-	-	-	
Inst.	5033	Create Xtender configuration file (masterfile)		-	-	-	-	-	-	-	-	-	
Expert	5034	Load Xtender configuration file (masterfile)		-	-	-	-	-	-	-	-	-	

Level	User ref.	Parameter	Unit	12			24			48			Mod. value
				Factory	Min	Max	Factory	Min	Max	Factory	Min	Max	
Expert	5045	Load Xtender parameters preset	Choose	1	-	-	1	-	-	1	-	-	
Expert	5051	Save and restore BSP files											
Expert	5052	Save BSP parameters		-	-	-	-	-	-	-	-	-	
Expert	5053	Load BSP parameters		-	-	-	-	-	-	-	-	-	
Inst.	5054	Create BSP configuration file (masterfile)		-	-	-	-	-	-	-	-	-	
Expert	5055	Load BSP configuration file (masterfile)		-	-	-	-	-	-	-	-	-	
Expert	5084	Save and restore VarioTrack files											
Expert	5085	Save VarioTrack parameters		-	-	-	-	-	-	-	-	-	
Expert	5086	Load VarioTrack parameters		-	-	-	-	-	-	-	-	-	
Inst.	5087	Create VarioTrack configuration file (masterfile)		-	-	-	-	-	-	-	-	-	
Expert	5088	Load VarioTrack configuration file (masterfile)		-	-	-	-	-	-	-	-	-	
Expert	5114	Save and restore VarioString files											
Expert	5115	Save VarioString parameters		-	-	-	-	-	-	-	-	-	
Expert	5116	Load VarioString parameters		-	-	-	-	-	-	-	-	-	
Inst.	5117	Create VarioString configuration file (masterfile)		-	-	-	-	-	-	-	-	-	
Expert	5118	Load VarioString configuration file (masterfile)		-	-	-	-	-	-	-	-	-	
Expert	5063	Save and restore MPPT Tristar files											
Expert	5064	Save MPPT Tristar parameters		-	-	-	-	-	-	-	-	-	
Expert	5065	Load MPPT Tristar parameters		-	-	-	-	-	-	-	-	-	
Inst.	5066	Create MPPT Tristar configuration file (masterfile)		-	-	-	-	-	-	-	-	-	
Expert	5067	Load MPPT Tristar configuration file (masterfile)		-	-	-	-	-	-	-	-	-	
Inst.	5047	Format the SD card		-	-	-	-	-	-	-	-	-	
Expert	5061	Start update		-	-	-	-	-	-	-	-	-	
Inst.	5042	MODIFICATION OF ACCESS LEVELS OF MANY PARAMETERS											
Inst.	5043	Change all parameters access level to:	Text	Choose	-	-	Choose	-	-	Choose	-	-	
Inst.	5044	Restore default access level of all parameters		-	-	-	-	-	-	-	-	-	
Basic	5007	BACKLIGHT											
Basic	5093	Backlight mode	Text	Delayed	-	-	Delayed	-	-	Delayed	-	-	
Basic	5009	Backlight switch off after	sec	120	5	120	120	5	120	120	5	120	
Expert	5026	Red backlight flashing on Xtender off and faulty	No/Yes	Yes	-	-	Yes	-	-	Yes	-	-	
Basic	5021	EXTENDED AND SPECIAL FUNCTIONS											
Basic	5006	Display contrast	%	45	0	100	45	0	100	45	0	100	
Expert	5073	Choice of standard display	Text	Xtender	-	-	Xtender	-	-	Xtender	-	-	
Expert	5010	Come back to standard display after	sec	600	5	600	600	5	600	600	5	600	
Expert	5011	Visibility of the transitory messages	sec	60	0	180	60	0	180	60	0	180	
Basic	5027	Acoustic alarm active	No/Yes	Yes	-	-	Yes	-	-	Yes	-	-	

Level	User ref.	Parameter	Unit	12			24			48			Mod. value
				Factory	Min	Max	Factory	Min	Max	Factory	Min	Max	
Expert	5031	Remote control acoustic alarm duration	sec	120	5	120	120	5	120	120	5	120	
Expert	5056	Switching ON and OFF of system on level "VIEW ONLY"	No/Yes	Yes	-	-	Yes	-	-	Yes	-	-	
Expert	5071	Reset of all the remotes control		-	-	-	-	-	-	-	-	-	
Expert	5121	Reset all devices of the system		-	-	-	-	-	-	-	-	-	
Expert	5094	SCOM											
Expert	5105	Test of the modem's GPRS signal level		-	-	-	-	-	-	-	-	-	
Inst.	5119	Device identification (LEDs) with the SCOM address		0	0	831	0	0	831	0	0	831	
Inst.	5095	Enable SCOM watchdog	No/Yes	No	-	-	No	-	-	No	-	-	
Inst.	5096	SCOM watchdog delay before reset of Xcom-232i	sec	60	10	300	60	10	300	60	10	300	

18.2 INVERTER PARAMETERS

Level	User ref.	Parameter	Unit	12			24			48			Mod. value
				Factory	Min	Max	Factory	Min	Max	Factory	Min	Max	
Basic	1100	BASIC SETTINGS											
Basic	1551	Basic parameters set by means of the potentiometer in the XTS	No/Yes	Yes	-	-	Yes	-	-	Yes	-	-	
Basic	1107	Maximum current of AC source (Input limit)	Aac	32	2	50	32	2	50	32	2	50	
Basic	1138	Battery charge current	Adc	60	0	200	60	0	200	60	0	200	
Basic	1126	Smart-Boost allowed	Yes/No	Yes	-	-	Yes	-	-	Yes	-	-	
Basic	1124	Inverter allowed	Yes/No	Yes	-	-	Yes	-	-	Yes	-	-	
Basic	1552	Type of detection of the grid loss (AC-In)	Text	Tolerant	-	-	Tolerant	-	-	Tolerant	-	-	
Basic	1187	Standby level	%	10	0	100	10	0	100	10	0	100	
Basic	1395	Restore default settings		-	-	-	-	-	-	-	-	-	
Inst.	1287	Restore factory settings		-	-	-	-	-	-	-	-	-	
Expert	1137	BATTERY MANAGEMENT AND CYCLE											
Expert	1125	Charger allowed	Yes/No	Yes	-	-	Yes	-	-	Yes	-	-	
Inst.	1646	Charger uses only power from ACout	No/Yes	No	-	-	No	-	-	No	-	-	
Basic	1138	Battery charge current	Adc	60	0	200	60	0	200	60	0	200	
Expert	1139	Temperature compensation	mV/°C/cell	-3	-8	0	-3	-8	0	-3	-8	0	
Expert	1568	Undervoltage											
Expert	1108	Battery undervoltage level without load	Vdc	11.6	9	18	23.2	18	36	46.3	36	72	
Expert	1531	Battery undervoltage dynamic compensation											
Expert	1191	Battery undervoltage dynamic compensation	No/Yes	Yes	-	-	Yes	-	-	Yes	-	-	
Expert	1532	Kind of dynamic compensation	Text	Automatic	-	-	Automatic	-	-	Automatic	-	-	

Level	User ref.	Parameter	Unit	12			24			48			Mod. value
				Factory	Min	Max	Factory	Min	Max	Factory	Min	Max	
Expert	1109	Battery undervoltage level at full load	Vdc	10.5	9	18	21	18	36	42	36	72	
Expert	1190	Battery undervoltage duration before turn off	min	3	0	60	3	0	60	3	0	60	
Expert	1110	Restart voltage after batteries undervoltage	Vdc	12	9.5	18	24	19	36	48	37.9	72	
Expert	1194	Battery adaptive low voltage (B.L.O)	No/Yes	No	-	-	No	-	-	No	-	-	
Expert	1195	Max voltage for adaptive low voltage	Vdc	12.5	9.5	18	25	19	36	49.9	37.9	72	
Expert	1307	Reset voltage for adaptive correction	Vdc	13.2	9.5	18	26.4	19	36	52.8	37.9	72	
Expert	1298	Increment step of the adaptive low voltage	Vdc	0.1	0	0.4	0.2	0	0.7	0.5	0	1.4	
Expert	1121	Battery overvoltage level	Vdc	17	9.5	18.6	34.1	19	37.2	68.2	37.9	74.4	
Expert	1122	Restart voltage level after an battery overvoltage	Vdc	16.2	9.5	18	32.4	19	36	64.8	37.9	72	
Expert	1140	Floating voltage	Vdc	13.6	9.5	18	27.2	19	36	54.4	37.9	72	
Expert	1467	Force phase of floating		-	-	-	-	-	-	-	-	-	
Expert	1141	New cycle menu											
Expert	1142	Force a new cycle		-	-	-	-	-	-	-	-	-	
Inst.	1608	Use dynamic compensation of battery level (new cycle)	No/Yes	No	-	-	No	-	-	No	-	-	
Expert	1143	Voltage level 1 to start a new cycle	Vdc	12.5	9	18	25	18	36	49.9	36	72	
Expert	1144	Time period under voltage level 1 to start a new cycle	min	30	0	240	30	0	240	30	0	240	
Expert	1145	Voltage level 2 to start a new cycle	Vdc	12.3	9	18	24.6	18	36	49.2	36	72	
Expert	1146	Time period under voltage level 2 to start a new cycle	sec	60	0	600	60	0	600	60	0	600	
Expert	1149	New cycle priority on absorption and equalization phases	No/Yes	No	-	-	No	-	-	No	-	-	
Expert	1147	Cycling restricted	No/Yes	No	-	-	No	-	-	No	-	-	
Expert	1148	Minimal delay between cycles	hours	3	0	540	3	0	540	3	0	540	
Expert	1451	Absorption phase											
Expert	1155	Absorption phase allowed	No/Yes	Yes	-	-	Yes	-	-	Yes	-	-	
Expert	1156	Absorption voltage	Vdc	14.4	9.5	18	28.8	19	36	57.6	37.9	72	
Expert	1157	Absorption duration	hours	2	0	18	2	0	18	2	0	18	
Expert	1158	End of absorption triggered with current	No/Yes	No	-	-	No	-	-	No	-	-	
Expert	1159	Current limit to quit the absorption phase	Adc	4	1	200	4	1	200	4	1	200	
Expert	1160	Maximal frequency of absorption control	No/Yes	No	-	-	No	-	-	No	-	-	
Expert	1161	Minimal delay since last absorption	hours	2	0	540	2	0	540	2	0	540	
Expert	1452	Equalization phase											
Expert	1163	Equalization allowed	No/Yes	No	-	-	No	-	-	No	-	-	
Expert	1162	Force equalization		-	-	-	-	-	-	-	-	-	
Expert	1291	Equalization before absorption phase	No/Yes	Yes	-	-	Yes	-	-	Yes	-	-	
Expert	1290	Equalization current	Adc	60	1	200	60	1	200	60	1	200	
Expert	1164	Equalization voltage	Vdc	15.6	9.5	18	31.2	19	36	62.4	37.9	72	
Expert	1165	Equalization duration	hours	0.5	0.2	10	0.5	0.2	10	0.5	0.2	10	

Level	User ref.	Parameter	Unit	12			24			48			Mod. value
				Factory	Min	Max	Factory	Min	Max	Factory	Min	Max	
Expert	1166	Number of cycles before an equalization		25	0	100	25	0	100	25	0	100	
Expert	1284	Equalization with fixed interval	No/Yes	No	-	-	No	-	-	No	-	-	
Expert	1285	Weeks between equalizations	weeks	26	1	104	26	1	104	26	1	104	
Expert	1168	End of equalization triggered with current	No/Yes	No	-	-	No	-	-	No	-	-	
Expert	1169	Current threshold to end equalization phase	Adc	4	1	30	4	1	30	4	1	30	
Expert	1453	Reduced floating phase											
Expert	1170	Reduced floating allowed	No/Yes	No	-	-	No	-	-	No	-	-	
Expert	1171	Floating duration before reduced floating	days	1	0	31	1	0	31	1	0	31	
Expert	1172	Reduced floating voltage	Vdc	13.2	9.5	18	26.4	19	36	52.8	37.9	72	
Expert	1454	Periodic absorption phase											
Expert	1173	Periodic absorption allowed	No/Yes	No	-	-	No	-	-	No	-	-	
Expert	1174	Periodic absorption voltage	Vdc	14.4	9.5	18	28.8	19	36	57.6	37.9	72	
Expert	1175	Reduced floating duration before periodic absorption	days	7	0	31	7	0	31	7	0	31	
Expert	1176	Periodic absorption duration	hours	0.5	0	10	0.5	0	10	0.5	0	10	
Expert	1186	INVERTER											
Basic	1124	Inverter allowed	Yes/No	Yes	-	-	Yes	-	-	Yes	-	-	
Expert	1286	AC Output voltage	Vac	230	110	280	230	110	280	230	110	280	
Expert	1548	AC voltage increase according to battery voltage	No/Yes	No	-	-	No	-	-	No	-	-	
Expert	1560	Max AC voltage increase with battery voltage	Vac	10	4	16	10	4	16	10	4	16	
Expert	1112	Inverter frequency	Hz	50	45	65	50	45	65	50	45	65	
Expert	1536	Inverter frequency increase when battery full	No/Yes	No	-	-	No	-	-	No	-	-	
Expert	1549	Inverter frequency increase according to battery voltage	No/Yes	No	-	-	No	-	-	No	-	-	
Expert	1546	Max frequency increase	Hz	4	0	10	4	0	10	4	0	10	
Expert	1534	Speed of voltage or frequency change in function of battery		0	-4	3	0	-4	3	0	-4	3	
Expert	1420	Standby and turn on											
Basic	1187	Standby level	%	10	0	100	10	0	100	10	0	100	
Expert	1189	Time delay between standby pulses	sec	0.8	0.2	10	0.8	0.2	10	0.8	0.2	10	
Expert	1188	Standby number of pulses		1	1	10	1	1	10	1	1	10	
Expert	1599	Softstart duration	sec	0	0	1	0	0	1	0	0	1	
Expert	1438	Solsafe presence Energy source at AC-Out side	No/Yes	No	-	-	No	-	-	No	-	-	
Expert	1197	AC-IN AND TRANSFER											
Expert	1128	Transfer relay allowed	Yes/No	Yes	-	-	Yes	-	-	Yes	-	-	
Expert	1580	Delay before closing transfer relay	min	0	0	30	0	0	30	0	0	30	
Basic	1126	Smart-Boost allowed	Yes/No	Yes	-	-	Yes	-	-	Yes	-	-	
Inst.	1607	Limitation of the power Boost	%	100	0	100	100	0	100	100	0	100	
Basic	1107	Maximum current of AC source (Input limit)	Aac	32	2	50	32	2	50	32	2	50	
Expert	1471	Max input current modification											

Level	User ref.	Parameter	Unit	12			24			48			Mod. value
				Factory	Min	Max	Factory	Min	Max	Factory	Min	Max	
Expert	1566	Using a secondary value for the maximum current of the AC source	No/Yes	No	-	-	No	-	-	No	-	-	
Expert	1567	Second maximum current of the AC source (Input limit)	Aac	16	2	50	16	2	50	16	2	50	
Expert	1527	Decrease max input limit current with AC-In voltage	No/Yes	No	-	-	No	-	-	No	-	-	
Expert	1554	Decrease of the max. current of the source with input voltage activated by remote entry	No/Yes	No	-	-	No	-	-	No	-	-	
Expert	1309	AC input low limit voltage to allow charger function	Vac	180	100	230	180	100	230	180	100	230	
Expert	1433	Adaptation range of the input current according to the input voltage	Vac	10	4	30	10	4	30	10	4	30	
Expert	1553	Speed of input limit increase		50	0	100	50	0	100	50	0	100	
Expert	1295	Charge current decrease coef. at voltage limit to turn back in inverter mode	%	100	0	100	100	0	100	100	0	100	
Expert	1436	Overrun AC source current limit without opening the transfer relay (Input limit)	No/Yes	Yes	-	-	Yes	-	-	Yes	-	-	
Basic	1552	Type of detection of the grid loss (AC-In)	Text	Tolerant	-	-	Tolerant	-	-	Tolerant	-	-	
Expert	1510	Tolerance on detection of AC-input loss (tolerant UPS mode)		100	2	120	100	2	120	100	2	120	
Expert	1199	Input voltage giving an opening of the transfer relay with delay	Vac	200	80	230	200	80	230	200	80	230	
Expert	1198	Time delay before opening of transfer relay	sec	8	0	30	8	0	30	8	0	30	
Expert	1200	Input voltage giving an immediate opening of the transfer relay (UPS)	Vac	180	80	230	180	80	230	180	80	230	
Inst.	1432	Absolute max limit for input voltage	Vac	270	235	290	270	235	290	270	235	290	
Expert	1505	Delta frequency allowed above the standard input frequency	Hz	5	0	35	5	0	35	5	0	35	
Expert	1506	Delta frequency allowed under the standard input frequency	Hz	5	0	15	5	0	15	5	0	15	
Expert	1507	Duration with frequency error before opening the transfer	sec	2	0	5	2	0	5	2	0	5	
Expert	1575	AC-IN current active filtering	No/Yes	No	-	-	No	-	-	No	-	-	
Inst.	1557	Use an energy quota on AC-input	No/Yes	No	-	-	No	-	-	No	-	-	
Inst.	1559	AC-in energy quota	kWh	1	0.5	100	1	0.5	100	1	0.5	100	
Expert	1201	AUXILIARY CONTACT 1											
Expert	1202	Operating mode (AUX 1)	Text	Automatic	-	-	Automatic	-	-	Automatic	-	-	
Expert	1497	Combination of the events for the auxiliary contact (AUX 1)	Text	Any (Function OR)	-	-	Any (Function OR)	-	-	Any (Function OR)	-	-	
Expert	1203	Temporal restrictions (AUX 1)											

Level	User ref.	Parameter	Unit	12			24			48			Mod. value
				Factory	Min	Max	Factory	Min	Max	Factory	Min	Max	
Expert	1204	Program 1 (AUX 1)											
Expert	1205	Day of the week (AUX 1)	days	None	None	Every day	None	None	Every day	None	None	Every day	
Expert	1206	Start hour (AUX 1)	hh:mm	07:00	00:00	24:00:00	07:00	00:00	24:00:00	07:00	00:00	24:00:00	
Expert	1207	End hour (AUX 1)	hh:mm	20:00	00:00	24:00:00	20:00	00:00	24:00:00	20:00	00:00	24:00:00	
Expert	1208	Program 2 (AUX 1)											
Expert	1209	Day of the week (AUX 1)	days	None	None	Every day	None	None	Every day	None	None	Every day	
Expert	1210	Start hour (AUX 1)	hh:mm	07:00	00:00	24:00:00	07:00	00:00	24:00:00	07:00	00:00	24:00:00	
Expert	1211	End hour (AUX 1)	hh:mm	20:00	00:00	24:00:00	20:00	00:00	24:00:00	20:00	00:00	24:00:00	
Expert	1212	Program 3 (AUX 1)											
Expert	1213	Day of the week (AUX 1)	days	None	None	Every day	None	None	Every day	None	None	Every day	
Expert	1214	Start hour (AUX 1)	hh:mm	07:00	00:00	24:00:00	07:00	00:00	24:00:00	07:00	00:00	24:00:00	
Expert	1215	End hour (AUX 1)	hh:mm	20:00	00:00	24:00:00	20:00	00:00	24:00:00	20:00	00:00	24:00:00	
Inst.	1216	Program 4 (AUX 1)											
Inst.	1217	Day of the week (AUX 1)	days	None	None	Every day	None	None	Every day	None	None	Every day	
Inst.	1218	Start hour (AUX 1)	hh:mm	07:00	00:00	24:00:00	07:00	00:00	24:00:00	07:00	00:00	24:00:00	
Inst.	1219	End hour (AUX 1)	hh:mm	20:00	00:00	24:00:00	20:00	00:00	24:00:00	20:00	00:00	24:00:00	
Inst.	1220	Program 5 (AUX 1)											
Inst.	1221	Day of the week (AUX 1)	days	None	None	Every day	None	None	Every day	None	None	Every day	
Inst.	1222	Start hour (AUX 1)	hh:mm	07:00	00:00	24:00:00	07:00	00:00	24:00:00	07:00	00:00	24:00:00	
Inst.	1223	End hour (AUX 1)	hh:mm	20:00	00:00	24:00:00	20:00	00:00	24:00:00	20:00	00:00	24:00:00	
Expert	1269	Contact active with a fixed time schedule (AUX 1)											
Expert	1270	Program 1 (AUX 1)											
Expert	1271	Day of the week (AUX 1)	days	None	None	Every day	None	None	Every day	None	None	Every day	
Expert	1272	Start hour (AUX 1)	hh:mm	07:00	00:00	24:00:00	07:00	00:00	24:00:00	07:00	00:00	24:00:00	
Expert	1273	End hour (AUX 1)	hh:mm	20:00	00:00	24:00:00	20:00	00:00	24:00:00	20:00	00:00	24:00:00	
Expert	1274	Program 2 (AUX 1)											
Expert	1275	Day of the week (AUX 1)	days	None	None	Every day	None	None	Every day	None	None	Every day	
Expert	1276	Start hour (AUX 1)	hh:mm	07:00	00:00	24:00:00	07:00	00:00	24:00:00	07:00	00:00	24:00:00	
Expert	1277	End hour (AUX 1)	hh:mm	20:00	00:00	24:00:00	20:00	00:00	24:00:00	20:00	00:00	24:00:00	
Expert	1278	Program 3 (AUX 1)											
Expert	1279	Day of the week (AUX 1)	days	None	None	Every day	None	None	Every day	None	None	Every day	
Expert	1280	Start hour (AUX 1)	hh:mm	07:00	00:00	24:00:00	07:00	00:00	24:00:00	07:00	00:00	24:00:00	

Level	User ref.	Parameter	Unit	12			24			48			Mod. value
				Factory	Min	Max	Factory	Min	Max	Factory	Min	Max	
Expert	1281	End hour (AUX 1)	hh:mm	20:00	00:00	24:00:00	20:00	00:00	24:00:00	20:00	00:00	24:00:00	
Expert	1455	Contact active on event (AUX 1)											
Expert	1225	Xtender is OFF (AUX 1)	No/Yes	No	-	-	No	-	-	No	-	-	
Expert	1518	Xtender ON (AUX 1)	No/Yes	No	-	-	No	-	-	No	-	-	
Expert	1543	Remote entry (AUX 1)	No/Yes	No	-	-	No	-	-	No	-	-	
Expert	1226	Battery undervoltage alarm (AUX 1)	No/Yes	No	-	-	No	-	-	No	-	-	
Expert	1227	Battery overvoltage (AUX 1)	No/Yes	No	-	-	No	-	-	No	-	-	
Expert	1228	Inverter overload (AUX 1)	No/Yes	No	-	-	No	-	-	No	-	-	
Expert	1229	Overtemperature (AUX 1)	No/Yes	No	-	-	No	-	-	No	-	-	
Expert	1520	No overtemperature (AUX 1)	No/Yes	No	-	-	No	-	-	No	-	-	
Expert	1231	Active charger (AUX 1)	No/Yes	No	-	-	No	-	-	No	-	-	
Expert	1232	Active inverter (AUX 1)	No/Yes	No	-	-	No	-	-	No	-	-	
Expert	1233	Active Smart-Boost (AUX 1)	No/Yes	No	-	-	No	-	-	No	-	-	
Expert	1234	AC input presence but with fault (AUX 1)	No/Yes	No	-	-	No	-	-	No	-	-	
Expert	1235	AC input presence (AUX 1)	No/Yes	No	-	-	No	-	-	No	-	-	
Expert	1236	Transfer relay ON (AUX 1)	No/Yes	No	-	-	No	-	-	No	-	-	
Expert	1237	AC out presence (AUX 1)	No/Yes	No	-	-	No	-	-	No	-	-	
Expert	1238	Bulk charge phase (AUX 1)	No/Yes	No	-	-	No	-	-	No	-	-	
Expert	1239	Absorption phase (AUX 1)	No/Yes	No	-	-	No	-	-	No	-	-	
Expert	1240	Equalization phase (AUX 1)	No/Yes	No	-	-	No	-	-	No	-	-	
Expert	1242	Floating (AUX 1)	No/Yes	No	-	-	No	-	-	No	-	-	
Expert	1243	Reduced floating (AUX 1)	No/Yes	No	-	-	No	-	-	No	-	-	
Expert	1244	Periodic absorption (AUX 1)	No/Yes	No	-	-	No	-	-	No	-	-	
Inst.	1601	AC-in energy quota (AUX1)	No/Yes	No	-	-	No	-	-	No	-	-	
Expert	1245	Contact active according to battery voltage (AUX 1)											
Expert	1288	Use dynamic compensation of battery level (AUX 1)	No/Yes	No	-	-	No	-	-	No	-	-	
Expert	1246	Battery voltage 1 activate (AUX 1)	No/Yes	Yes	-	-	Yes	-	-	Yes	-	-	
Expert	1247	Battery voltage 1 (AUX 1)	Vdc	11.7	9	18	23.4	18	36	46.8	36	72	
Expert	1248	Delay 1 (AUX 1)	min	1	0	60	1	0	60	1	0	60	
Expert	1249	Battery voltage 2 activate (AUX 1)	No/Yes	Yes	-	-	Yes	-	-	Yes	-	-	
Expert	1250	Battery voltage 2 (AUX 1)	Vdc	11.9	9	18	23.9	18	36	47.8	36	72	
Expert	1251	Delay 2 (AUX 1)	min	10	0	60	10	0	60	10	0	60	
Expert	1252	Battery voltage 3 activate (AUX 1)	No/Yes	Yes	-	-	Yes	-	-	Yes	-	-	
Expert	1253	Battery voltage 3 (AUX 1)	Vdc	12.1	9	18	24.2	18	36	48.5	36	72	
Expert	1254	Delay 3 (AUX 1)	min	60	0	60	60	0	60	60	0	60	
Expert	1255	Battery voltage to deactivate (AUX 1)	Vdc	13.5	9	18	27	18	36	54	36	72	
Expert	1256	Delay to deactivate (AUX 1)	min	60	0	480	60	0	480	60	0	480	

Level	User ref.	Parameter	Unit	12			24			48			Mod. value
				Factory	Min	Max	Factory	Min	Max	Factory	Min	Max	
Expert	1516	Deactivate if battery in floating phase (AUX 1)	No/Yes	Yes	-	-	Yes	-	-	Yes	-	-	
Expert	1257	Contact active with inverter power or Smart-Boost (AUX 1)											
Expert	1258	Inverter power level 1 activate (AUX 1)	No/Yes	No	-	-	No	-	-	No	-	-	
Expert	1259	Power level 1 (AUX 1)	% Pnom	120	20	120	120	20	120	120	20	120	
Expert	1260	Time delay 1 (AUX 1)	min	1	0	60	1	0	60	1	0	60	
Expert	1261	Inverter power level 2 activate (AUX 1)	No/Yes	No	-	-	No	-	-	No	-	-	
Expert	1262	Power level 2 (AUX 1)	% Pnom	80	20	120	80	20	120	80	20	120	
Expert	1263	Time delay 2 (AUX 1)	min	5	0	60	5	0	60	5	0	60	
Expert	1264	Inverter power level 3 activate (AUX 1)	No/Yes	No	-	-	No	-	-	No	-	-	
Expert	1265	Power level 3 (AUX 1)	% Pnom	50	20	120	50	20	120	50	20	120	
Expert	1266	Time delay 3 (AUX 1)	min	30	0	60	30	0	60	30	0	60	
Expert	1267	Inverter power level to deactivate (AUX 1)	% Pnom	40	20	120	40	20	120	40	20	120	
Expert	1268	Time delay to deactivate (AUX 1)	min	5	0	60	5	0	60	5	0	60	
Inst.	1503	Contact active according to battery temperature (AUX 1) With BSP or BTS											
Inst.	1446	Contact activated with the temperature of battery (AUX 1)	No/Yes	No	-	-	No	-	-	No	-	-	
Inst.	1447	Contact activated over (AUX 1)	°C	3	-10	50	3	-10	50	3	-10	50	
Inst.	1448	Contact deactivated below (AUX 1)	°C	5	-10	50	5	-10	50	5	-10	50	
Expert	1501	Contact active according to SOC (AUX 1) Only with BSP											
Expert	1439	Contact activated with the SOC 1 of battery (AUX 1)	No/Yes	No	-	-	No	-	-	No	-	-	
Expert	1440	Contact activated below SOC 1 (AUX 1)	% SOC	50	0	100	50	0	100	50	0	100	
Expert	1581	Delay 1 (AUX 1)	hours	12	0	99	12	0	99	12	0	99	
Expert	1582	Contact activated with the SOC 2 of battery (AUX 1)	No/Yes	No	-	-	No	-	-	No	-	-	
Expert	1583	Contact activated below SOC 2 (AUX 1)	%	30	0	100	30	0	100	30	0	100	
Expert	1584	Delay 2 (AUX 1)	hours	0.2	0	99	0.2	0	99	0.2	0	99	
Expert	1585	Contact activated with the SOC 3 of battery (AUX 1)	No/Yes	No	-	-	No	-	-	No	-	-	
Expert	1586	Contact activated below SOC 3 (AUX 1)	%	20	0	100	20	0	100	20	0	100	
Expert	1587	Delay 3 (AUX 1)	hours	0	0	99	0	0	99	0	0	99	
Expert	1441	Contact deactivated over SOC (AUX 1)	% SOC	90	0	100	90	0	100	90	0	100	
Expert	1588	Delay to deactivate (AUX 1)	hours	0.2	0	10	0.2	0	10	0.2	0	10	
Expert	1589	Deactivate if battery in floating phase (AUX 1)	No/Yes	Yes	-	-	Yes	-	-	Yes	-	-	
Expert	1512	Security, maximum time of contact (AUX 1)	No/Yes	No	-	-	No	-	-	No	-	-	
Expert	1514	Maximum time of operation of contact (AUX 1)	min	600	10	1200	600	10	1200	600	10	1200	
Expert	1569	Reset all settings (AUX 1)		-	-	-	-	-	-	-	-	-	
Expert	1310	AUXILIARY CONTACT 2											

Level	User ref.	Parameter	Unit	12			24			48			Mod. value
				Factory	Min	Max	Factory	Min	Max	Factory	Min	Max	
Expert	1311	Operating mode (AUX 2)	Text	Reversed automatic	-	-	Reversed automatic	-	-	Reversed automatic	-	-	
Expert	1498	Combination of the events for the auxiliary contact (AUX 2)	Text	Any (Function OR)	-	-	Any (Function OR)	-	-	Any (Function OR)	-	-	
Expert	1312	Temporal restrictions (AUX 2)											
Expert	1313	Program 1 (AUX 2)											
Expert	1314	Day of the week (AUX 2)	days	None	None	Every day	None	None	Every day	None	None	Every day	
Expert	1315	Start hour (AUX 2)	hh:mm	07:00	00:00	24:00:00	07:00	00:00	24:00:00	07:00	00:00	24:00:00	
Expert	1316	End hour (AUX 2)	hh:mm	20:00	00:00	24:00:00	20:00	00:00	24:00:00	20:00	00:00	24:00:00	
Expert	1317	Program 2 (AUX 2)											
Expert	1318	Day of the week (AUX 2)	days	None	None	Every day	None	None	Every day	None	None	Every day	
Expert	1319	Start hour (AUX 2)	hh:mm	07:00	00:00	24:00:00	07:00	00:00	24:00:00	07:00	00:00	24:00:00	
Expert	1320	End hour (AUX 2)	hh:mm	20:00	00:00	24:00:00	20:00	00:00	24:00:00	20:00	00:00	24:00:00	
Expert	1321	Program 3 (AUX 2)											
Expert	1322	Day of the week (AUX 2)	days	None	None	Every day	None	None	Every day	None	None	Every day	
Expert	1323	Start hour (AUX 2)	hh:mm	07:00	00:00	24:00:00	07:00	00:00	24:00:00	07:00	00:00	24:00:00	
Expert	1324	End hour (AUX 2)	hh:mm	20:00	00:00	24:00:00	20:00	00:00	24:00:00	20:00	00:00	24:00:00	
Inst.	1325	Program 4 (AUX 2)											
Inst.	1326	Day of the week (AUX 2)	days	None	None	Every day	None	None	Every day	None	None	Every day	
Inst.	1327	Start hour (AUX 2)	hh:mm	07:00	00:00	24:00:00	07:00	00:00	24:00:00	07:00	00:00	24:00:00	
Inst.	1328	End hour (AUX 2)	hh:mm	20:00	00:00	24:00:00	20:00	00:00	24:00:00	20:00	00:00	24:00:00	
Inst.	1329	Program 5 (AUX 2)											
Inst.	1330	Day of the week (AUX 2)	days	None	None	Every day	None	None	Every day	None	None	Every day	
Inst.	1331	Start hour (AUX 2)	hh:mm	07:00	00:00	24:00:00	07:00	00:00	24:00:00	07:00	00:00	24:00:00	
Inst.	1332	End hour (AUX 2)	hh:mm	20:00	00:00	24:00:00	20:00	00:00	24:00:00	20:00	00:00	24:00:00	
Expert	1378	Contact active with a fixed time schedule (AUX 2)											
Expert	1379	Program 1 (AUX 2)											
Expert	1380	Day of the week (AUX 2)	days	None	None	Every day	None	None	Every day	None	None	Every day	
Expert	1381	Start hour (AUX 2)	hh:mm	07:00	00:00	24:00:00	07:00	00:00	24:00:00	07:00	00:00	24:00:00	
Expert	1382	End hour (AUX 2)	hh:mm	20:00	00:00	24:00:00	20:00	00:00	24:00:00	20:00	00:00	24:00:00	
Expert	1383	Program 2 (AUX 2)											
Expert	1384	Day of the week (AUX 2)	days	None	None	Every day	None	None	Every day	None	None	Every day	

Level	User ref.	Parameter	Unit	12			24			48			Mod. value
				Factory	Min	Max	Factory	Min	Max	Factory	Min	Max	
Expert	1385	Start hour (AUX 2)	hh:mm	07:00	00:00	24:00:00	07:00	00:00	24:00:00	07:00	00:00	24:00:00	
Expert	1386	End hour (AUX 2)	hh:mm	20:00	00:00	24:00:00	20:00	00:00	24:00:00	20:00	00:00	24:00:00	
Expert	1387	Program 3 (AUX 2)											
Expert	1388	Day of the week (AUX 2)	days	None	None	Every day	None	None	Every day	None	None	Every day	
Expert	1389	Start hour (AUX 2)	hh:mm	07:00	00:00	24:00:00	07:00	00:00	24:00:00	07:00	00:00	24:00:00	
Expert	1390	End hour (AUX 2)	hh:mm	20:00	00:00	24:00:00	20:00	00:00	24:00:00	20:00	00:00	24:00:00	
Expert	1456	Contact active on event (AUX 2)											
Expert	1333	Xtender is OFF (AUX 2)	No/Yes	Yes	-	-	Yes	-	-	Yes	-	-	
Expert	1519	Xtender ON (AUX 2)	No/Yes	No	-	-	No	-	-	No	-	-	
Expert	1544	Remote entry (AUX 2)	No/Yes	No	-	-	No	-	-	No	-	-	
Expert	1334	Battery undervoltage alarm (AUX 2)	No/Yes	Yes	-	-	Yes	-	-	Yes	-	-	
Expert	1335	Battery overvoltage (AUX 2)	No/Yes	Yes	-	-	Yes	-	-	Yes	-	-	
Expert	1336	Inverter overload (AUX 2)	No/Yes	Yes	-	-	Yes	-	-	Yes	-	-	
Expert	1337	Overtemperature (AUX 2)	No/Yes	Yes	-	-	Yes	-	-	Yes	-	-	
Expert	1521	No overtemperature (AUX 2)	No/Yes	No	-	-	No	-	-	No	-	-	
Expert	1339	Active charger (AUX 2)	No/Yes	No	-	-	No	-	-	No	-	-	
Expert	1340	Active inverter (AUX 2)	No/Yes	No	-	-	No	-	-	No	-	-	
Expert	1341	Active Smart-Boost (AUX 2)	No/Yes	No	-	-	No	-	-	No	-	-	
Expert	1342	AC input presence but with fault (AUX 2)	No/Yes	No	-	-	No	-	-	No	-	-	
Expert	1343	AC input presence (AUX 2)	No/Yes	No	-	-	No	-	-	No	-	-	
Expert	1344	Transfer contact ON (AUX 2)	No/Yes	No	-	-	No	-	-	No	-	-	
Expert	1345	AC out presence (AUX 2)	No/Yes	No	-	-	No	-	-	No	-	-	
Expert	1346	Bulk charge phase (AUX 2)	No/Yes	No	-	-	No	-	-	No	-	-	
Expert	1347	Absorption phase (AUX 2)	No/Yes	No	-	-	No	-	-	No	-	-	
Expert	1348	Equalization phase (AUX 2)	No/Yes	No	-	-	No	-	-	No	-	-	
Expert	1350	Floating (AUX 2)	No/Yes	No	-	-	No	-	-	No	-	-	
Expert	1351	Reduced floating (AUX 2)	No/Yes	No	-	-	No	-	-	No	-	-	
Expert	1352	Periodic absorption (AUX 2)	No/Yes	No	-	-	No	-	-	No	-	-	
Inst.	1602	AC-in energy quota (AUX2)	No/Yes	No	-	-	No	-	-	No	-	-	
Expert	1353	Contact active according to battery voltage (AUX 2)											
Expert	1354	Use dynamic compensation of battery level (AUX 2)	No/Yes	No	-	-	No	-	-	No	-	-	
Expert	1355	Battery voltage 1 activate (AUX 2)	No/Yes	No	-	-	No	-	-	No	-	-	
Expert	1356	Battery voltage 1 (AUX 2)	Vdc	12	9	18	24	18	36	48	36	72	
Expert	1357	Delay 1 (AUX 2)	min	5	0	60	5	0	60	5	0	60	
Expert	1358	Battery voltage 2 activate (AUX 2)	No/Yes	No	-	-	No	-	-	No	-	-	
Expert	1359	Battery voltage 2 (AUX 2)	Vdc	11.5	9	18	23	18	36	46.1	36	72	
Expert	1360	Delay 2 (AUX 2)	min	5	0	60	5	0	60	5	0	60	

Level	User ref.	Parameter	Unit	12			24			48			Mod. value
				Factory	Min	Max	Factory	Min	Max	Factory	Min	Max	
Expert	1361	Battery voltage 3 activate (AUX 2)	No/Yes	No	-	-	No	-	-	No	-	-	
Expert	1362	Battery voltage 3 (AUX 2)	Vdc	11	9	18	22.1	18	36	44.2	36	72	
Expert	1363	Delay 3 (AUX 2)	min	5	0	60	5	0	60	5	0	60	
Expert	1364	Battery voltage to deactivate (AUX 2)	Vdc	12.6	9	18	25.2	18	36	50.4	36	72	
Expert	1365	Delay to deactivate (AUX 2)	min	5	0	480	5	0	480	5	0	480	
Expert	1517	Deactivate if battery in floating phase (AUX 2)	No/Yes	No	-	-	No	-	-	No	-	-	
Expert	1366	Contact active with inverter power or Smart-Boost (AUX 2)											
Expert	1367	Inverter power level 1 activate (AUX 2)	No/Yes	No	-	-	No	-	-	No	-	-	
Expert	1368	Power level 1 (AUX 2)	% Pnom	120	20	120	120	20	120	120	20	120	
Expert	1369	Time delay 1 (AUX 2)	min	0	0	60	0	0	60	0	0	60	
Expert	1370	Inverter power level 2 activate (AUX 2)	No/Yes	No	-	-	No	-	-	No	-	-	
Expert	1371	Power level 2 (AUX 2)	% Pnom	80	20	120	80	20	120	80	20	120	
Expert	1372	Time delay 2 (AUX 2)	min	5	0	60	5	0	60	5	0	60	
Expert	1373	Inverter power level 3 activate (AUX 2)	No/Yes	No	-	-	No	-	-	No	-	-	
Expert	1374	Power level 3 (AUX 2)	% Pnom	50	20	120	50	20	120	50	20	120	
Expert	1375	Time delay 3 (AUX 2)	min	30	0	60	30	0	60	30	0	60	
Expert	1376	Inverter power level to deactivate (AUX 2)	% Pnom	40	20	120	40	20	120	40	20	120	
Expert	1377	Time delay to deactivate (AUX 2)	min	5	0	60	5	0	60	5	0	60	
Inst.	1504	Contact active according to battery temperature (AUX 2) With BSP or BTS											
Inst.	1457	Contact activated with the temperature of battery (AUX 2)	No/Yes	No	-	-	No	-	-	No	-	-	
Inst.	1458	Contact activated over (AUX 2)	°C	3	-10	50	3	-10	50	3	-10	50	
Inst.	1459	Contact deactivated below (AUX 2)	°C	5	-10	50	5	-10	50	5	-10	50	
Expert	1502	Contact active according to SOC (AUX 2) Only with BSP											
Expert	1442	Contact activated with the SOC 1 of battery (AUX 2)	No/Yes	No	-	-	No	-	-	No	-	-	
Expert	1443	Contact activated below SOC 1 (AUX 2)	% SOC	50	0	100	50	0	100	50	0	100	
Expert	1590	Delay 1 (AUX 2)	hours	12	0	99	12	0	99	12	0	99	
Expert	1591	Contact activated with the SOC 2 of battery (AUX 2)	No/Yes	No	-	-	No	-	-	No	-	-	
Expert	1592	Contact activated below SOC 2 (AUX 2)	%	30	0	100	30	0	100	30	0	100	
Expert	1593	Delay 2 (AUX 2)	hours	0.2	0	99	0.2	0	99	0.2	0	99	
Expert	1594	Contact activated with the SOC 3 of battery (AUX 2)	No/Yes	No	-	-	No	-	-	No	-	-	
Expert	1595	Contact activated below SOC 3 (AUX 2)	%	20	0	100	20	0	100	20	0	100	
Expert	1596	Delay 3 (AUX 2)	hours	0	0	99	0	0	99	0	0	99	
Expert	1444	Contact deactivated over SOC (AUX 2)	% SOC	90	0	100	90	0	100	90	0	100	
Expert	1597	Delay to deactivate (AUX 2)	hours	0.2	0	10	0.2	0	10	0.2	0	10	
Expert	1598	Deactivate if battery in floating phase (AUX 2)	No/Yes	Yes	-	-	Yes	-	-	Yes	-	-	

Level	User ref.	Parameter	Unit	12			24			48			Mod. value
				Factory	Min	Max	Factory	Min	Max	Factory	Min	Max	
Expert	1513	Security, maximum time of contact (AUX 2)	No/Yes	No	-	-	No	-	-	No	-	-	
Expert	1515	Maximum time of operation of contact (AUX 2)	min	600	10	1200	600	10	1200	600	10	1200	
Expert	1570	Reset all settings (AUX 2)		-	-	-	-	-	-	-	-	-	
Expert	1489	AUXILIARY CONTACTS 1 AND 2 EXTENDED FUNCTIONS											
Expert	1491	Generator control active	No/Yes	No	-	-	No	-	-	No	-	-	
Expert	1493	Number of starting attempts		5	0	20	5	0	20	5	0	20	
Expert	1492	Starter pulse duration (with AUX2)	sec	3	1	20	3	1	20	3	1	20	
Expert	1494	Time before a starter pulse	sec	3	1	20	3	1	20	3	1	20	
Expert	1574	Main contact hold/interrupt time	sec	0	0	30	0	0	30	0	0	30	
Expert	1101	SYSTEM											
Expert	1537	Remote entry (Remote ON/OFF)											
Expert	1545	Remote entry active	Closed/Op en	Open	-	-	Open	-	-	Open	-	-	
Expert	1538	Prohibits transfert relay	No/Yes	No	-	-	No	-	-	No	-	-	
Expert	1539	Prohibits inverter	No/Yes	No	-	-	No	-	-	No	-	-	
Expert	1540	Prohibits charger	No/Yes	No	-	-	No	-	-	No	-	-	
Expert	1541	Prohibits Smart-Boost	No/Yes	No	-	-	No	-	-	No	-	-	
Expert	1542	Prohibits grid feeding	No/Yes	No	-	-	No	-	-	No	-	-	
Expert	1566	Using a secondary value for the maximum current of the AC source	No/Yes	No	-	-	No	-	-	No	-	-	
Expert	1567	Second maximum current of the AC source (Input limit)	Aac	16	2	50	16	2	50	16	2	50	
Expert	1554	Decrease of the max. current of the source with input voltage activated by remote entry	No/Yes	No	-	-	No	-	-	No	-	-	
Expert	1576	ON/OFF command	No/Yes	No	-	-	No	-	-	No	-	-	
Expert	1578	Activated by AUX1 state	No/Yes	No	-	-	No	-	-	No	-	-	
Expert	1579	Prohibits battery priority	No/Yes	No	-	-	No	-	-	No	-	-	
Inst.	1600	Disable minigrid mode	No/Yes	No	-	-	No	-	-	No	-	-	
Inst.	1647	Prohibits charger using only power from ACout	No/Yes	No	-	-	No	-	-	No	-	-	
Expert	1296	Batteries priority as energy source	No/Yes	No	-	-	No	-	-	No	-	-	
Expert	1297	Battery priority voltage	Vdc	12.9	9.5	18	25.8	19	36	51.6	37.9	72	
Expert	1565	Buzzer alarm duration	min	0	0	60	0	0	60	0	0	60	
Expert	1129	Auto restarts											
Expert	1130	After battery undervoltage	No/Yes	Yes	-	-	Yes	-	-	Yes	-	-	
Expert	1304	Number of batteries undervoltage allowed before definitive stop		3	1	20	3	1	20	3	1	20	
Expert	1404	Time period for batteries undervoltages counting	sec	0	0	3000	0	0	3000	0	0	3000	

Level	User ref.	Parameter	Unit	12			24			48			Mod. value
				Factory	Min	Max	Factory	Min	Max	Factory	Min	Max	
Expert	1305	Number of batteries critical undervoltage allowed before definitive stop		10	1	20	10	1	20	10	1	20	
Expert	1405	Time period for critical batteries undervoltages counting	sec	10	0	3000	10	0	3000	10	0	3000	
Expert	1131	After battery overvoltage	No/Yes	Yes	-	-	Yes	-	-	Yes	-	-	
Expert	1132	After inverter or Smart-Boost overload	No/Yes	Yes	-	-	Yes	-	-	Yes	-	-	
Expert	1533	Delay to restart after an overload	sec	5	2	120	5	2	120	5	2	120	
Expert	1134	After overtemperature	No/Yes	Yes	-	-	Yes	-	-	Yes	-	-	
Expert	1111	Autostart to the battery connection	No/Yes	No	-	-	No	-	-	No	-	-	
Expert	1484	System earthing (Earth - Neutral)											
Expert	1485	Prohibited ground relay	No/Yes	Yes	-	-	Yes	-	-	Yes	-	-	
Expert	1486	Continuous neutral	No/Yes	No	-	-	No	-	-	No	-	-	
Inst.	1628	Xtender watchdog enabled (SCOM)	No/Yes	No	-	-	No	-	-	No	-	-	
Inst.	1629	Xtender watchdog delay (SCOM)	sec	60	10	300	60	10	300	60	10	300	
Basic	1395	Restore default settings		-	-	-	-	-	-	-	-	-	
Inst.	1287	Restore factory settings		-	-	-	-	-	-	-	-	-	
Inst.	1550	Parameters saved in flash memory	No/Yes	Yes	-	-	Yes	-	-	Yes	-	-	
Inst.	1415	ON of the Xtenders		-	-	-	-	-	-	-	-	-	
Inst.	1399	OFF of the Xtenders		-	-	-	-	-	-	-	-	-	
Expert	1468	Reset of all the inverters		-	-	-	-	-	-	-	-	-	
Expert	1282	MULTI XTENDER SYSTEM											
Expert	1283	Integral mode	No/Yes	Yes	-	-	Yes	-	-	Yes	-	-	
Expert	1461	Multi inverters allowed	Yes/No	Yes	-	-	Yes	-	-	Yes	-	-	
Expert	1462	Multi inverters independents. Need reset {1468}	No/Yes	No	-	-	No	-	-	No	-	-	
Expert	1555	Battery cycle synchronized by the master	No/Yes	Yes	-	-	Yes	-	-	Yes	-	-	
Expert	1547	Allow slaves standby in multi-Xtender system	No/Yes	Yes	-	-	Yes	-	-	Yes	-	-	
Expert	1571	Splitphase: L2 with 180 degrees phaseshift	No/Yes	No	-	-	No	-	-	No	-	-	
Inst.	1437	Minigrid compatible	No/Yes	No	-	-	No	-	-	No	-	-	
Inst.	1577	Minigrid with shared battery energy	No/Yes	No	-	-	No	-	-	No	-	-	
Inst.	1556	is central inverter in distributed minigrid	No/Yes	No	-	-	No	-	-	No	-	-	
Expert	1522	GRID-FEEDING											
Expert	1127	Grid feeding allowed	Yes/No	No	-	-	No	-	-	No	-	-	
Expert	1523	Max grid feeding current	Aac	10	0	50	10	0	50	10	0	50	
Expert	1524	Battery voltage target for forced grid feeding	Vdc	12	9.5	18	24	19	36	48	37.9	72	
Expert	1525	Forced grid feeding start time	hh:mm	20:00	00:00	24:00:00	20:00	00:00	24:00:00	20:00	00:00	24:00:00	
Expert	1526	Forced grid feeding stop time	hh:mm	20:00	00:00	24:00:00	20:00	00:00	24:00:00	20:00	00:00	24:00:00	
Inst.	1610	Use of the defined phase shift curve for injection	No/Yes	No	-	-	No	-	-	No	-	-	

Level	User ref.	Parameter	Unit	12			24			48			Mod. value
				Factory	Min	Max	Factory	Min	Max	Factory	Min	Max	
Inst.	1622	Cos phi at P = 0%	Text	1	-	-	1	-	-	1	-	-	
Inst.	1623	Cos phi at the power defined by param {1613}	Text	1	-	-	1	-	-	1	-	-	
Inst.	1613	Power of the second cos phi point in % of Pnom	%	50	20	85	50	20	85	50	20	85	
Inst.	1624	Cos phi at P = 100%	Text	1	-	-	1	-	-	1	-	-	
Inst.	1627	ARN4105 frequency control enabled	No/Yes	No	-	-	No	-	-	No	-	-	
Inst.	1630	Delta from user frequency to start derating	Hz	1	0	3.9	1	0	3.9	1	0	3.9	
Inst.	1631	Delta from user frequency to reach 100% derating	Hz	2	0	3.9	2	0	3.9	2	0	3.9	

19 PARAMETER INDEX {XXXX}

{1100}.....	35	{1176}.....	50	{1244}.....	62
{1101}.....	66	{1186}.....	50	{1245}.....	62, 76
{1107}.....	14, 17, 28, 29, 36, 37, 42, 54, 55, 56, 71, 75, 76	{1187}.....	38, 53, 75	{1246}.....	62, 76
{1108}.....	27, 43, 77	{1188}.....	53	{1247}.....	62, 76
{1109}.....	43, 77	{1189}.....	53	{1248}.....	62, 76
{1110}.....	44, 77	{1190}.....	43	{1249}.....	62
{1111}.....	69	{1191}.....	43	{1250}.....	62
{1112}.....	51, 58, 71	{1194}.....	44	{1251}.....	63
{1121}.....	44, 77	{1195}.....	44, 77	{1252}.....	63
{1122}.....	44, 77	{1197}.....	54	{1253}.....	63
{1124}.....	37, 50	{1198}.....	54, 57	{1254}.....	63
{1125}.....	42, 58, 76	{1199}.....	54, 57, 77	{1255}.....	63, 76
{1126}.....	37, 54, 58, 67, 75, 76	{1200}.....	54, 57, 77	{1256}.....	63, 76
{1127}.....	71	{1201}.....	58	{1257}.....	63
{1128}.....	54	{1202}.....	59, 76	{1258}.....	63
{1129}.....	68	{1203}.....	60	{1259}.....	63
{1130}.....	68	{1204}.....	60	{1260}.....	63
{1131}.....	68	{1205}.....	60	{1261}.....	63
{1132}.....	68	{1206}.....	60	{1262}.....	63
{1134}.....	68	{1207}.....	60	{1263}.....	63
{1137}.....	39	{1208}.....	60	{1264}.....	63
{1138}.....	15, 36, 42, 48, 75	{1209}.....	60	{1265}.....	63
{1139}.....	42	{1210}.....	60	{1266}.....	63
{1140}.....	39, 44, 52, 75, 77	{1211}.....	60	{1267}.....	63
{1141}.....	44	{1212}.....	60	{1268}.....	63
{1142}.....	45	{1213}.....	60	{1269}.....	60
{1143}	45	{1214}.....	60	{1270}.....	60
{1145}	45	{1215}.....	60	{1271}.....	60
{1146}	45	{1216}.....	60	{1272}.....	60
{1147}.....	46	{1217}.....	60	{1273}.....	60
{1148}.....	46	{1218}.....	60	{1274}.....	60
{1149}.....	46	{1219}.....	60	{1275}.....	60
{1155}.....	46	{1220}.....	60	{1276}.....	61
{1156}.....	39, 46, 75, 77	{1221}.....	60	{1277}.....	61
{1157}.....	46, 75	{1222}.....	60	{1278}.....	61
{1158}.....	47	{1223}.....	60	{1279}.....	61
{1159}.....	47	{1225}.....	61	{1280}.....	61
{1160}.....	47	{1226}.....	61	{1281}.....	61
{1161}.....	47	{1227}.....	61	{1282}.....	70
{1162}.....	48	{1228}.....	61	{1283}.....	70
{1163}.....	47	{1229}.....	61	{1284}.....	48
{1164}.....	48, 77	{1231}.....	61	{1285}.....	48, 49
{1165}.....	48	{1232}.....	61	{1286}.....	50, 51, 71
{1166}.....	48	{1233}.....	61	{1287}.....	38
{1168}.....	49	{1234}.....	62	{1288}.....	62, 63
{1169}.....	49	{1235}.....	62	{1290}.....	48
{1170}.....	49	{1236}.....	62	{1291}.....	48
{1171}.....	49	{1237}.....	62	{1295}.....	56
{1172}.....	49, 77	{1238}.....	62	{1296}.....	67
{1173}.....	50	{1239}.....	62	{1297}.....	67
{1174}.....	50, 77	{1240}.....	62	{1298}.....	44
{1175}.....	50	{1242}.....	62	{1304}.....	68
		{1243}.....	62	{1305}.....	68

{1307}.....	44	{1368}.....	63	{1489}.....	65
{1309}.....	54, 56	{1369}.....	63	{1491}.....	65
{1310}.....	58	{1370}.....	63	{1492}.....	65
{1311}.....	59	{1371}.....	63	{1493}.....	65
{1312}.....	60	{1372}.....	63	{1494}.....	65
{1313}.....	60	{1373}.....	63	{1497}.....	60
{1314}.....	60	{1374}.....	63	{1498}.....	60
{1315}.....	60	{1375}.....	63	{1501}.....	64
{1316}.....	60	{1376}.....	63	{1502}.....	64
{1317}.....	60	{1377}.....	63	{1503}.....	63
{1318}.....	60	{1378}.....	60	{1504}.....	63
{1319}.....	60	{1379}.....	60	{1505}.....	51, 58
{1320}.....	60	{1380}.....	60	{1506}.....	51, 58
{1321}.....	60	{1381}.....	60	{1507}.....	58
{1322}.....	60	{1382}.....	60	{1510}.....	37, 57
{1323}.....	60	{1383}.....	60	{1512}.....	31, 64
{1324}.....	60	{1384}.....	60	{1513}.....	31, 64
{1325}.....	60	{1385}.....	61	{1514}.....	31, 64
{1326}.....	60	{1386}.....	61	{1515}.....	31, 64
{1327}.....	60	{1387}.....	61	{1516}.....	63
{1328}.....	60	{1388}.....	61	{1517}.....	63
{1329}.....	60	{1389}.....	61	{1518}.....	61
{1330}.....	60	{1390}.....	61	{1519}.....	61
{1331}.....	60	{1395}.....	38	{1520}.....	61
{1332}.....	60	{1404}.....	68	{1521}.....	61
{1333}.....	61	{1405}.....	68	{1522}.....	71
{1334}.....	61	{1420}.....	53	{1523}.....	71, 72
{1335}.....	61	{1432}.....	57	{1524}.....	72
{1336}.....	61	{1433}.....	56, 71	{1525}.....	72
{1337}.....	61	{1436}.....	29, 56, 75	{1526}.....	72
{1339}.....	61	{1437}.....	70	{1527}.....	56, 66
{1340}.....	61	{1438}.....	30, 54	{1531}.....	43
{1341}.....	61	{1439}.....	64	{1532}.....	43
{1342}.....	62	{1440}.....	64	{1533}.....	68
{1343}.....	62	{1441}.....	64	{1534}.....	53
{1344}.....	62	{1442}.....	64	{1536}.....	30, 52, 53
{1345}.....	62	{1443}.....	64	{1537}.....	66
{1346}.....	62	{1444}.....	64	{1538}.....	66
{1347}.....	62	{1446}.....	63	{1539}.....	66
{1348}.....	62	{1447}.....	63	{1540}.....	66
{1350}.....	62	{1448}.....	63	{1541}.....	66
{1351}.....	62	{1451}.....	46	{1542}.....	66
{1352}.....	62	{1452}.....	47	{1543}.....	61
{1353}.....	62	{1453}.....	49	{1544}.....	61
{1354}.....	62, 63	{1454}.....	50	{1545}.....	66
{1355}.....	62	{1455}.....	61	{1546}.....	52, 53
{1356}.....	62	{1456}.....	61	{1547}.....	70
{1357}.....	62	{1457}.....	63	{1548}.....	51, 53
{1358}.....	62	{1458}.....	63	{1549}.....	30, 52, 53
{1359}.....	62	{1459}.....	63	{1550}.....	69
{1360}.....	63	{1461}.....	70	{1551}.....	35
{1361}.....	63	{1462}.....	70	{1552}.....	37, 57
{1362}.....	63	{1467}.....	44	{1554}.....	56, 66
{1363}.....	63	{1468}.....	69	{1555}.....	70
{1364}.....	63	{1471}.....	55	{1557}.....	58
{1365}.....	63	{1484}.....	69	{1559}.....	58
{1366}.....	63	{1485}.....	69	{1560}.....	51
{1367}.....	63	{1486}.....	69	{1565}.....	67

{1566}.....	55, 56, 66	{1597}.....	64	{5026}	22
{1567}.....	55, 56, 66	{1598}.....	64	{5027}	23
{1568}.....	43	{1599}.....	54	{5030}	21
{1569}.....	59, 64	{1600}.....	67	{5031}	23
{1570}.....	59, 64	{1601}.....	62	{5032}	21
{1571}.....	70	{1602}.....	62	{5033}	21
{1574}.....	65	{1607}.....	55	{5034}	21
{1575}.....	58	{1608}.....	45	{5036}	18
{1576}.....	66	{1610}.....	72	{5038}	18
{1577}.....	71	{1613}.....	73	{5039}	18
{1578}.....	67	{1622}.....	73	{5040}	18
{1579}.....	67	{1623}.....	73	{5041}	20
{1580}.....	54	{1624}.....	73	{5042}	22
{1581}.....	64	{1646}.....	42	{5043}	22
{1582}.....	64	{1647}.....	67	{5044}	22
{1583}.....	64	{5000}.....	18	{5045}	22
{1584}.....	64	{5001}.....	19	{5047}	22
{1585}.....	64	{5002}.....	19	{5049}	21
{1586}.....	64	{5006}.....	22	{5050}	21
{1587}.....	64	{5007}.....	22	{5056}	23
{1588}.....	64	{5009}.....	22	{5057}	19
{1589}.....	64	{5010}.....	23	{5059}	20
{1590}.....	64	{5011}.....	23	{5061}	22
{1591}.....	64	{5012}.....	19	{5068}	20
{1592}.....	64	{5013}.....	20	{5069}	21
{1593}.....	64	{5017}.....	21	{5070}	20
{1594}.....	64	{5018}.....	21	{5073}	22
{1595}.....	64	{5019}.....	19	{5093}	22
{1596}.....	64	{5021}.....	22	{5101}	19



Studer Innotec SA
Rue des Casernes 57
1950 Sion – Switzerland
Phone: +41(0) 27 205 60 80
Fax : +41(0) 27 205 60 88

info@studer-innotec.com
www.studer-innotec.com