

BFP520

Surface mount low voltage silicon NPN RF bipolar transistor



Product description

The BFP520 is a low noise device based on a grounded emitter (SIEGET™) that is part of Infineon’s established fifth generation RF bipolar transistor family. Its transition frequency f_T of 45 GHz, high gain, low noise and voltage characteristics at high frequencies make the device suitable for low voltage applications. It remains cost competitive without compromising on ease of use.



Feature list

- Minimum noise figure $NF_{min} = 0.95$ dB at 1.8 GHz, 2 V, 2 mA
- High gain $G_{ms} = 24$ dB at 1.8 GHz, 2 V, 20 mA
- $OIP_3 = 25$ dBm at 1.8 GHz, 2 V, 20 mA

Product validation

Qualified for industrial applications according to the relevant tests of JEDEC47/20/22.

Potential applications

- Radio-frequency oscillators such as an LNB local oscillator
- Broadband low noise amplifiers (LNAs) for CATV, DVB-T, DAB/DMB and FM/AM radio
- LNAs for wireless communications such as cordless phones

Device information

Table 1 Part information

Product name / Ordering code	Package	Pin configuration				Marking	Pieces / Reel
BFP520 / BFP520H6327XTSA1	SOT343	1 = B	2 = E	3 = C	4 = E	APs	3000

Attention: ESD (Electrostatic discharge) sensitive device, observe handling precautions

Table of contents

Table of contents

	Product description	1
	Feature list	1
	Product validation	1
	Potential applications	1
	Device information	1
	Table of contents	2
1	Absolute maximum ratings	3
2	Thermal characteristics	4
3	Electrical characteristics	5
3.1	DC characteristics	5
3.2	General AC characteristics	5
3.3	Frequency dependent AC characteristics	6
3.4	Characteristic AC diagrams	7
4	Package information SOT343	12
	Revision history	13
	Disclaimer	14

Absolute maximum ratings

1 Absolute maximum ratings

Table 2 Absolute maximum ratings at $T_A = 25\text{ °C}$ (unless otherwise specified)

Parameter	Symbol	Values		Unit	Note or test condition
		Min.	Max.		
Collector emitter voltage	V_{CEO}	-	2.5	V	Open base
			2.4		$T_A = -55\text{ °C}$, open base
Collector emitter voltage	V_{CES}		10		E-B short circuited
Collector base voltage	V_{CBO}		10		Open emitter
Emitter base voltage	V_{EBO}		1		Open collector
Base current	I_B		5	mA	-
Collector current	I_C		50		
Total power dissipation ¹⁾	P_{tot}		125	mW	$T_S \leq 105\text{ °C}$
Junction temperature	T_J		150	°C	-
Storage temperature	T_{Stg}	-55			

Attention: *Stresses above the max. values listed here may cause permanent damage to the device. Exposure to absolute maximum rating conditions for extended periods may affect device reliability. Exceeding only one of these values may cause irreversible damage to the integrated circuit.*

¹ T_S is the soldering point temperature. T_S is measured on the emitter lead at the soldering point of the PCB.

Thermal characteristics

2 Thermal characteristics

Table 3 Thermal resistance

Parameter	Symbol	Values			Unit	Note or test condition
		Min.	Typ.	Max.		
Junction - soldering point	R_{thJS}	-	450	-	K/W	-

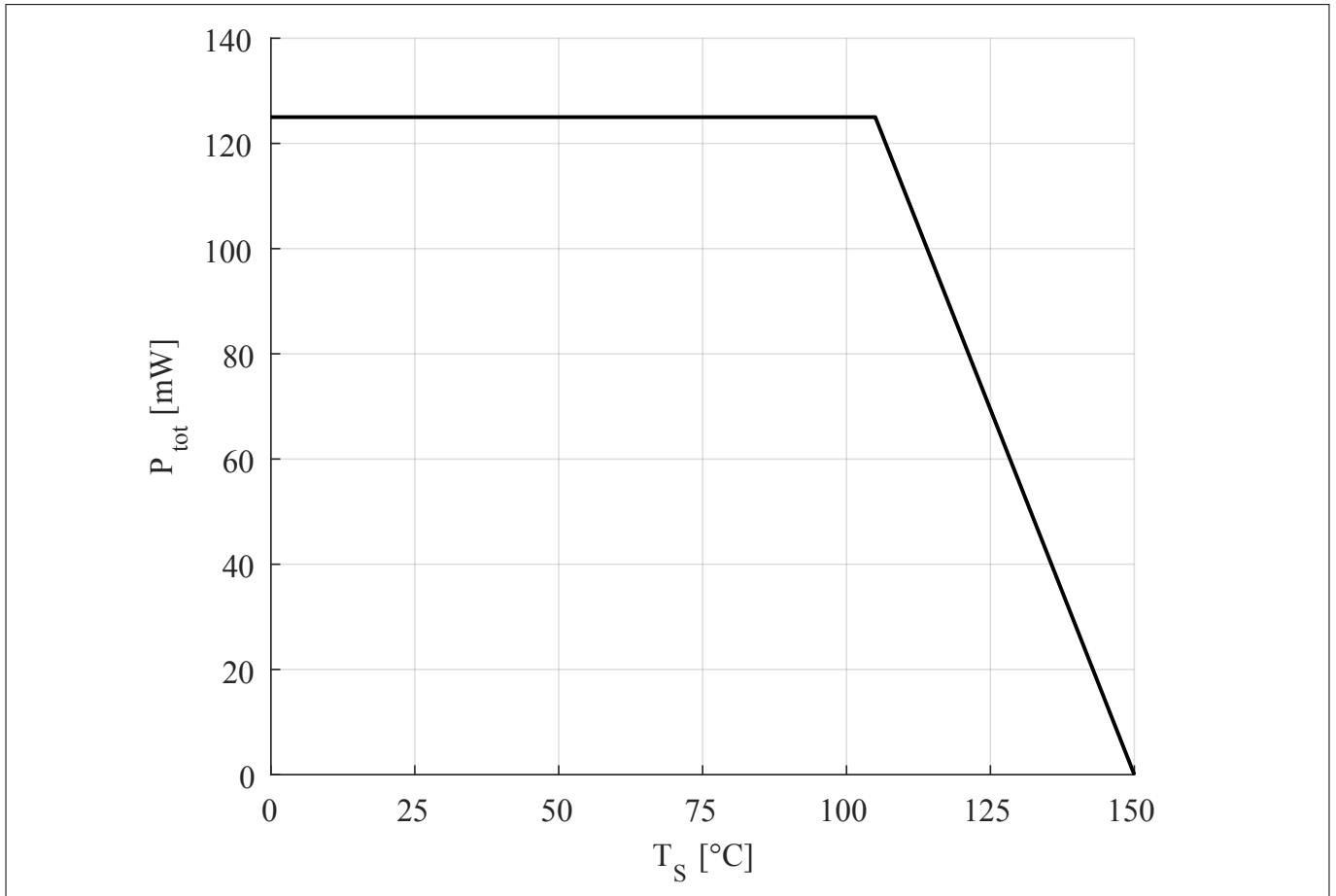

Figure 1 Total power dissipation $P_{tot} = f(T_s)$

Electrical characteristics

3 Electrical characteristics

3.1 DC characteristics

Table 4 DC characteristics at $T_A = 25\text{ °C}$

Parameter	Symbol	Values			Unit	Note or test condition
		Min.	Typ.	Max.		
Collector emitter breakdown voltage	$V_{(BR)CEO}$	2.5	3	3.5	V	$I_C = 1\text{ mA}$, $I_B = 0$, open base
Collector emitter leakage current	I_{CES}	-	1	30 ²⁾	nA	$V_{CE} = 2\text{ V}$, $V_{BE} = 0$, E-B short circuited
			-	1000 ²⁾		$V_{CE} = 10\text{ V}$, $V_{BE} = 0$, E-B short circuited
Collector base leakage current	I_{CBO}			30 ²⁾		$V_{CB} = 2\text{ V}$, $I_E = 0$, open emitter
Emitter base leakage current	I_{EBO}		100	3000 ²⁾		$V_{EB} = 0.5\text{ V}$, $I_C = 0$, open collector
DC current gain	h_{FE}	70	110	170		$V_{CE} = 2\text{ V}$, $I_C = 20\text{ mA}$, pulse measured

3.2 General AC characteristics

Table 5 General AC characteristics at $T_A = 25\text{ °C}$

Parameter	Symbol	Values			Unit	Note or test condition
		Min.	Typ.	Max.		
Transition frequency	f_T	32	45	-	GHz	$V_{CE} = 2\text{ V}$, $I_C = 30\text{ mA}$, $f = 2\text{ GHz}$
Collector base capacitance	C_{CB}	-	0.07	0.13	pF	$V_{CB} = 2\text{ V}$, $V_{BE} = 0$, $f = 1\text{ MHz}$, emitter grounded
Collector emitter capacitance	C_{CE}		0.3	-		$V_{CE} = 2\text{ V}$, $V_{BE} = 0$, $f = 1\text{ MHz}$, base grounded
Emitter base capacitance	C_{EB}		0.33			$V_{EB} = 0.5\text{ V}$, $V_{CB} = 0$, $f = 1\text{ MHz}$, collector grounded

² Maximum values not limited by the device but by the short cycle time of the 100% test.

Electrical characteristics

3.3 Frequency dependent AC characteristics

Measurement setup is a test fixture with Bias-T's in a 50 Ω system, $T_A = 25\text{ °C}$.

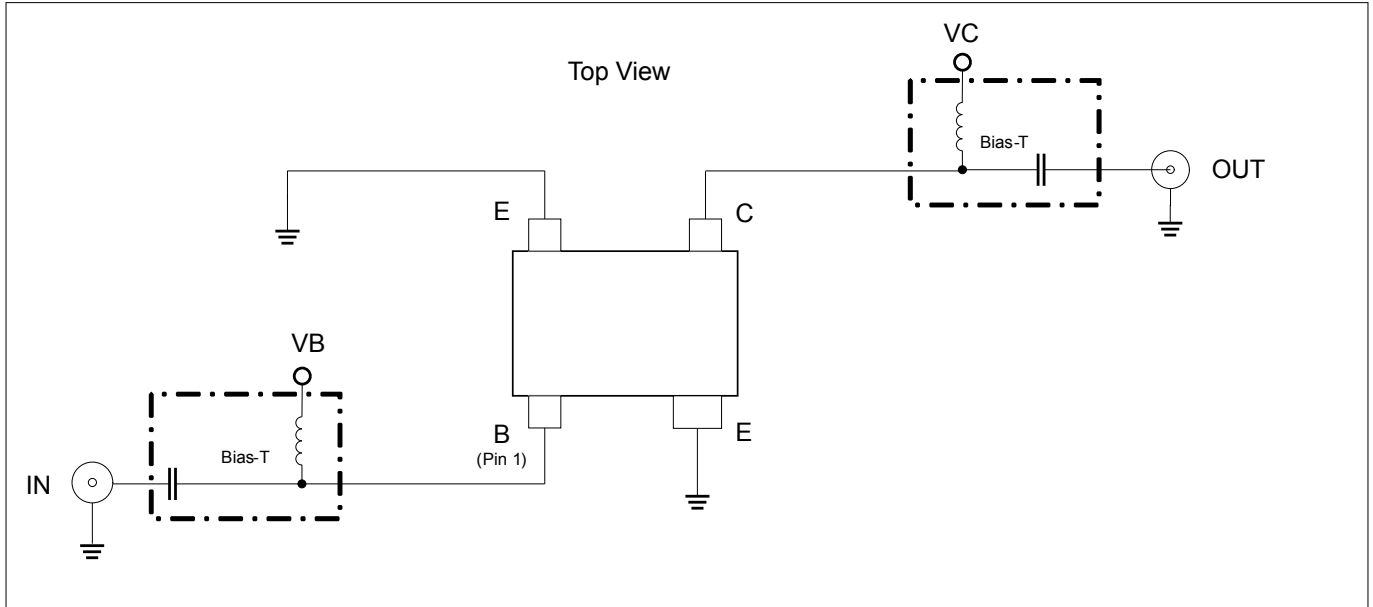

Figure 2 Testing circuit

Table 6 AC characteristics, $V_{CE} = 2\text{ V}$, $f = 1.8\text{ GHz}$

Parameter	Symbol	Values			Unit	Note or test condition	
		Min.	Typ.	Max.			
Power gain		-		-	dB	$I_C = 20\text{ mA}$	
• Maximum power gain	G_{ms}		24				
• Transducer gain	$ S_{21} ^2$		21.5				
Noise figure					dBm	$I_C = 2\text{ mA}$	
• Minimum noise figure	NF_{min}		0.95				
Linearity					$Z_S = Z_{S,opt}$, $Z_L = Z_{L,opt}$	$I_C = 20\text{ mA}$	
• 3rd order intercept point at output	OIP_3		25				
			17				$I_C = 7\text{ mA}$
• 1 dB gain compression point at output	OP_{1dB}		12				$I_C = 20\text{ mA}$
			5		$I_C = 7\text{ mA}$		

Note: $G_{ms} = |S_{21}/S_{12}|$ for $k < 1$; $G_{ma} = |S_{21}/S_{12}|(k/(k^2-1))^{1/2}$ for $k > 1$. In order to get the NF_{min} values stated in this chapter, the test fixture losses have been subtracted from all measured results. OIP_3 value depends on termination of all intermodulation frequency components. Termination used for this measurement is 50 Ω from 0.1 MHz to 6 GHz.

Electrical characteristics

3.4 Characteristic AC diagrams

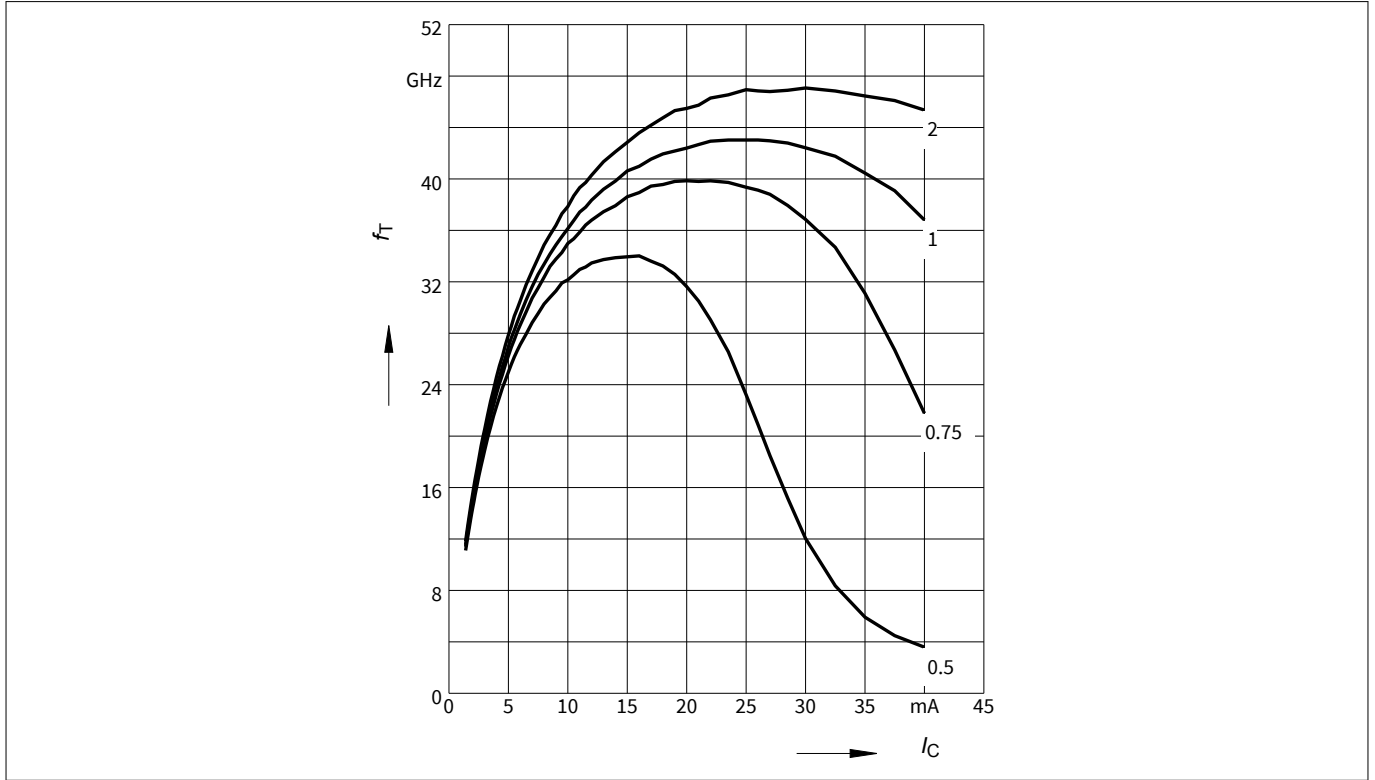

Figure 3 Transition frequency $f_T = f(I_C)$, $f = 2$ GHz, $V_{CE} = \text{parameter}$

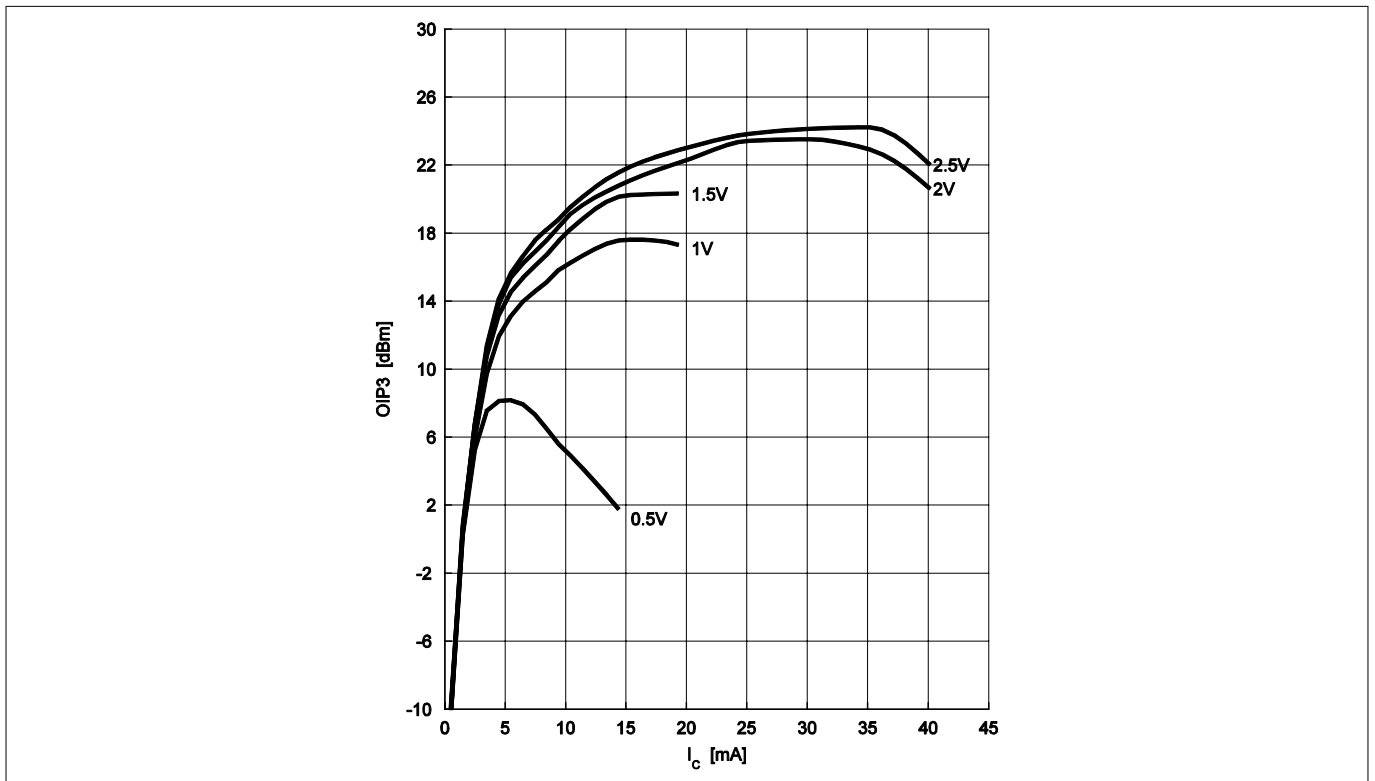

Figure 4 3rd order intercept point $OIP_3 = f(I_C)$, $Z_S = Z_L = 50 \Omega$, $f = 900$ MHz, $V_{CE} = \text{parameter}$

Electrical characteristics

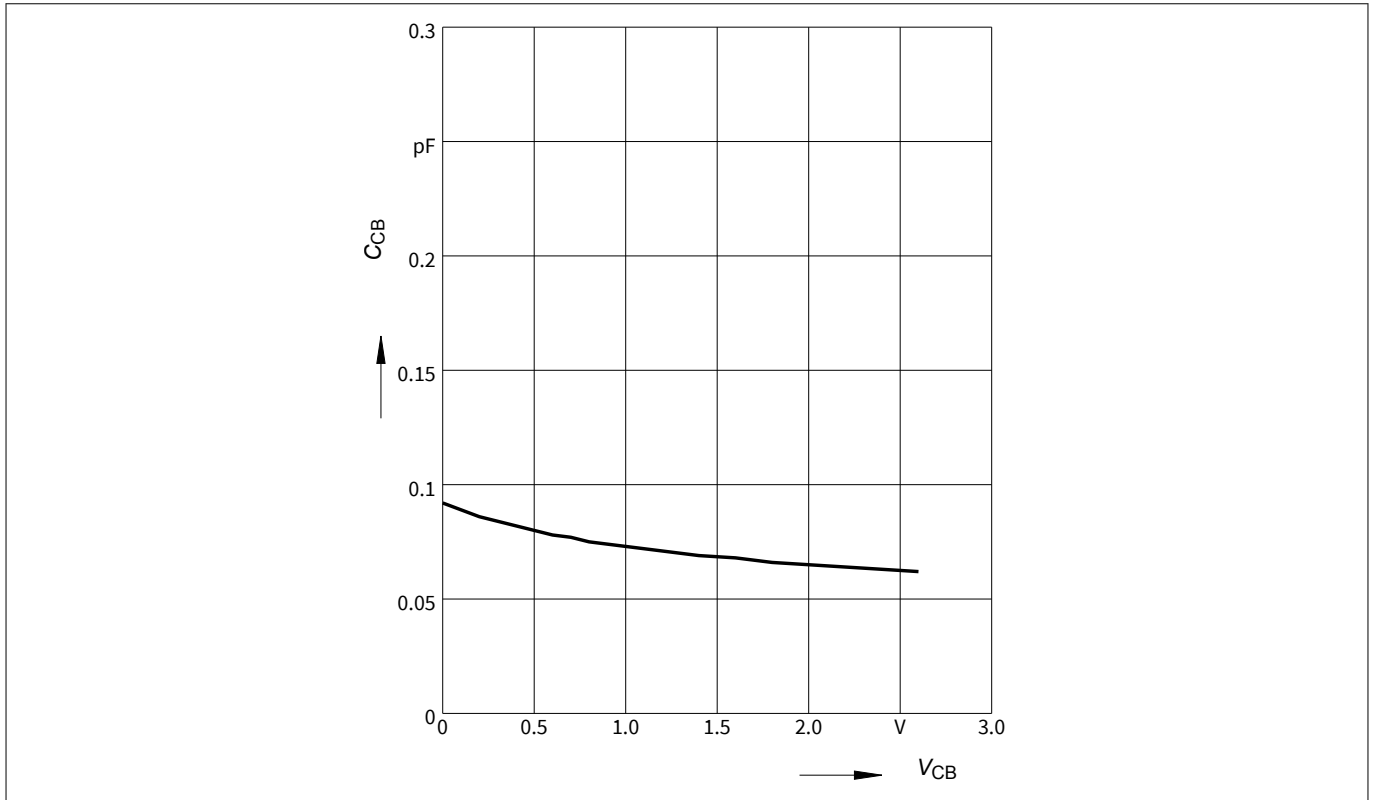

Figure 5 Collector base capacitance $C_{CB} = f(V_{CB}), f = 1$ MHz

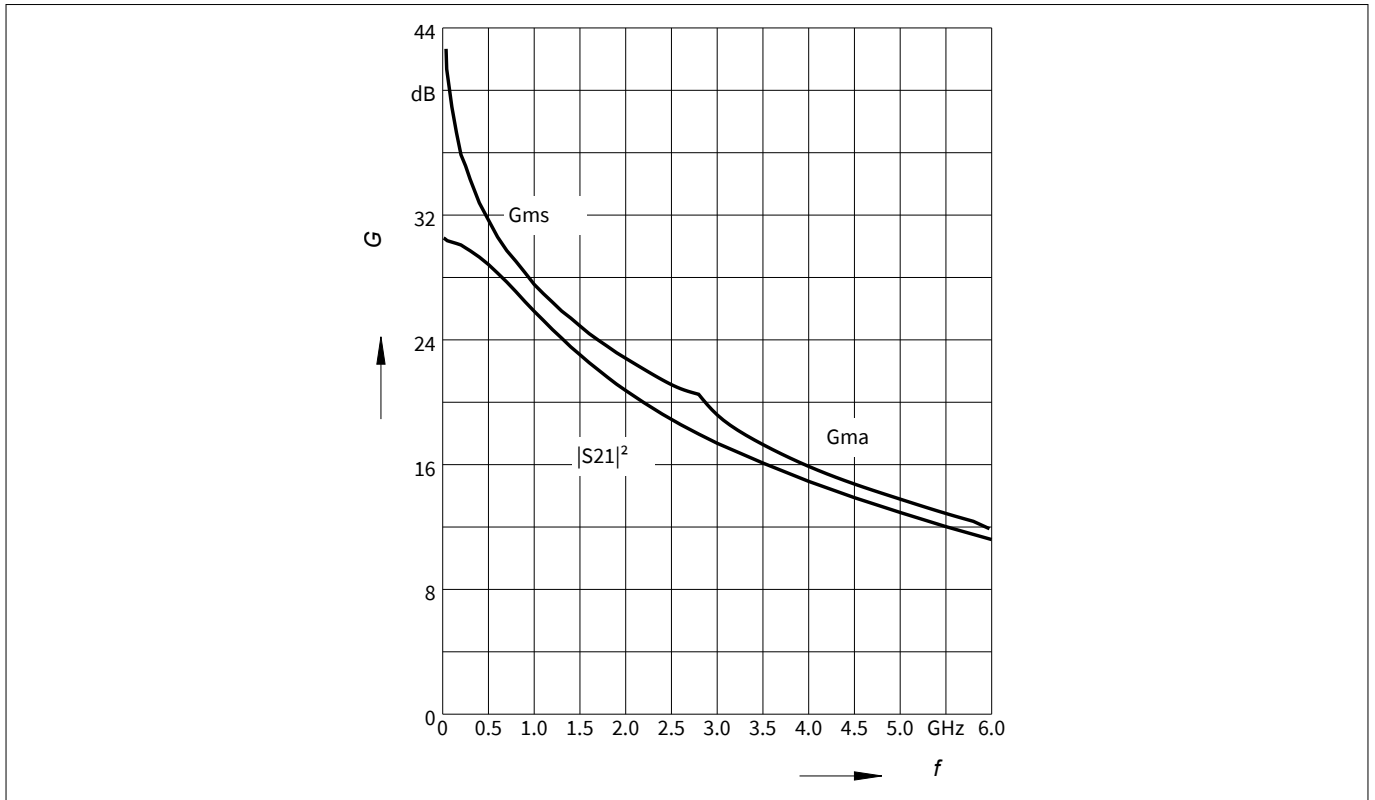

Figure 6 Gain $G_{ma}, G_{ms}, |S_{21}|^2 = f(f), V_{CE} = 2$ V, $I_C = 20$ mA

Electrical characteristics

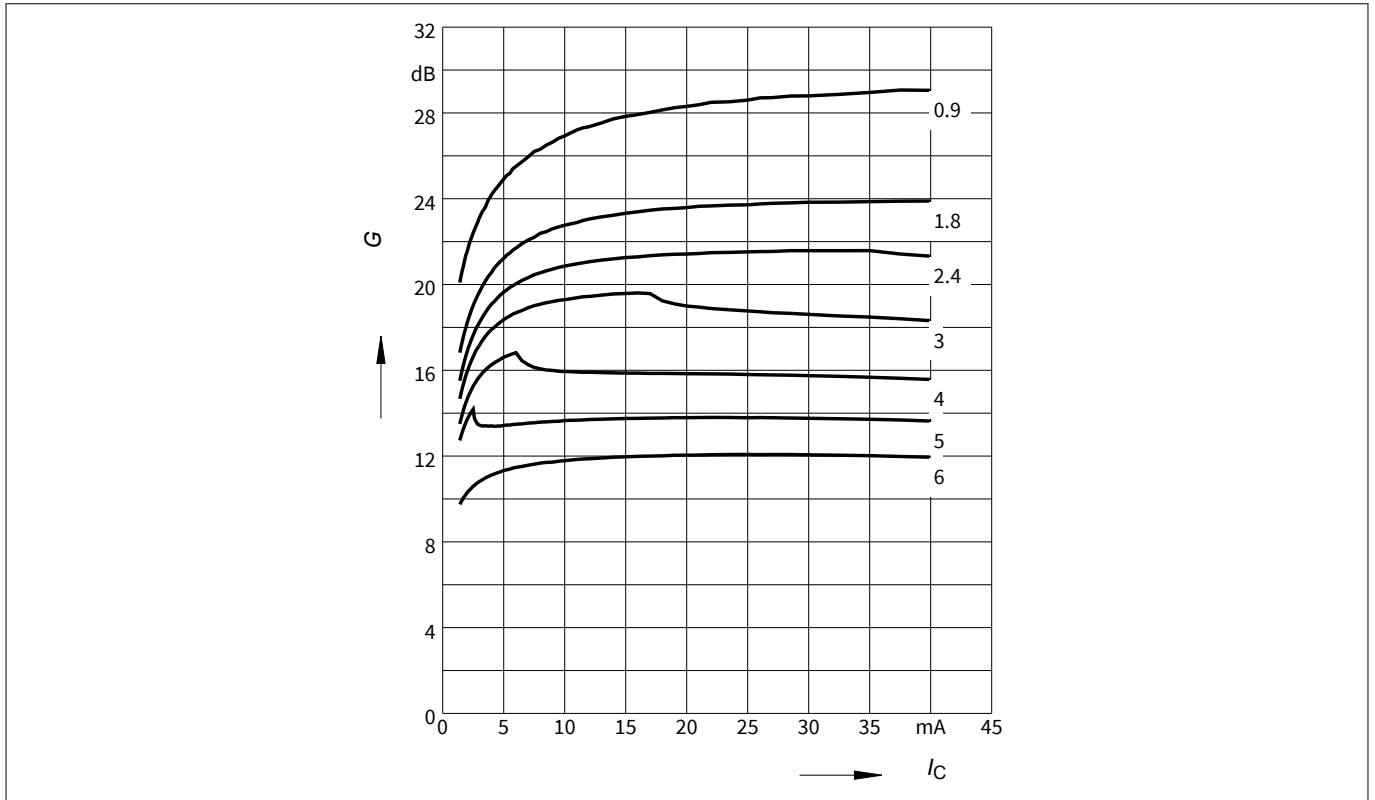

Figure 7 Maximum power gain $G_{max} = f(I_C)$, $V_{CE} = 2$ V, $f =$ parameter in GHz

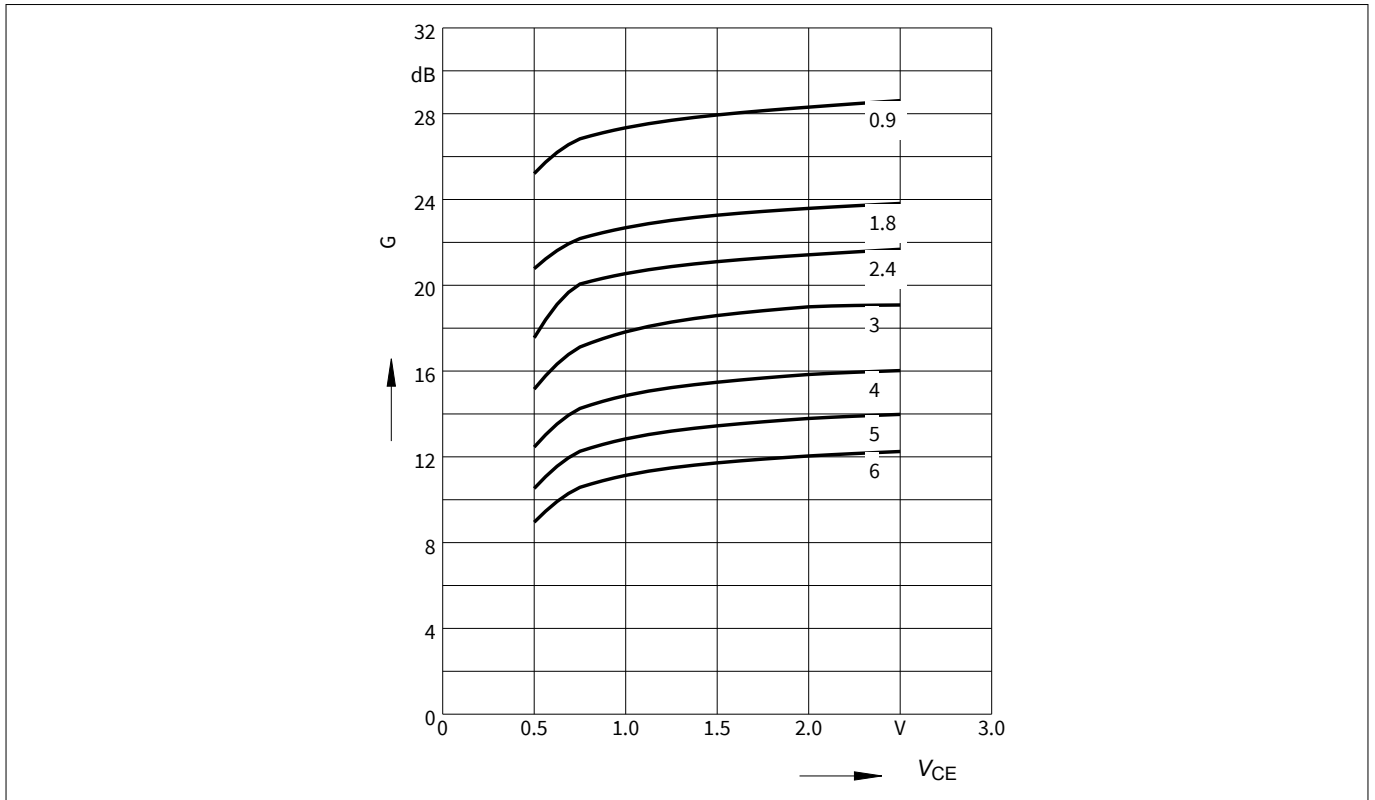

Figure 8 Maximum power gain $G_{max} = f(V_{CE})$, $I_C = 20$ mA, $f =$ parameter in GHz

Electrical characteristics

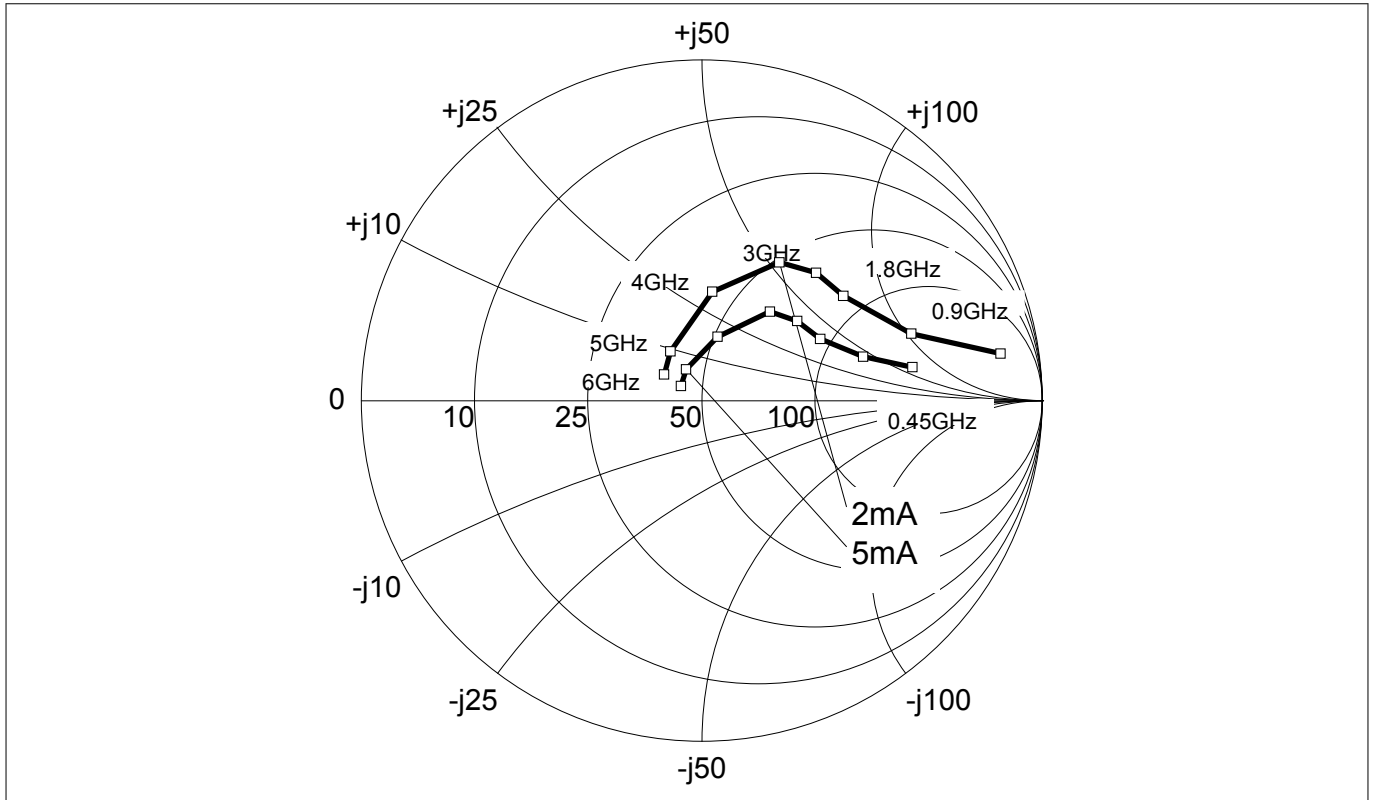

Figure 9 Source impedance for minimum noise figure $Z_{S,opt} = f(f)$, $V_{CE} = 2\text{ V}$, $I_C = 2 / 5\text{ mA}$

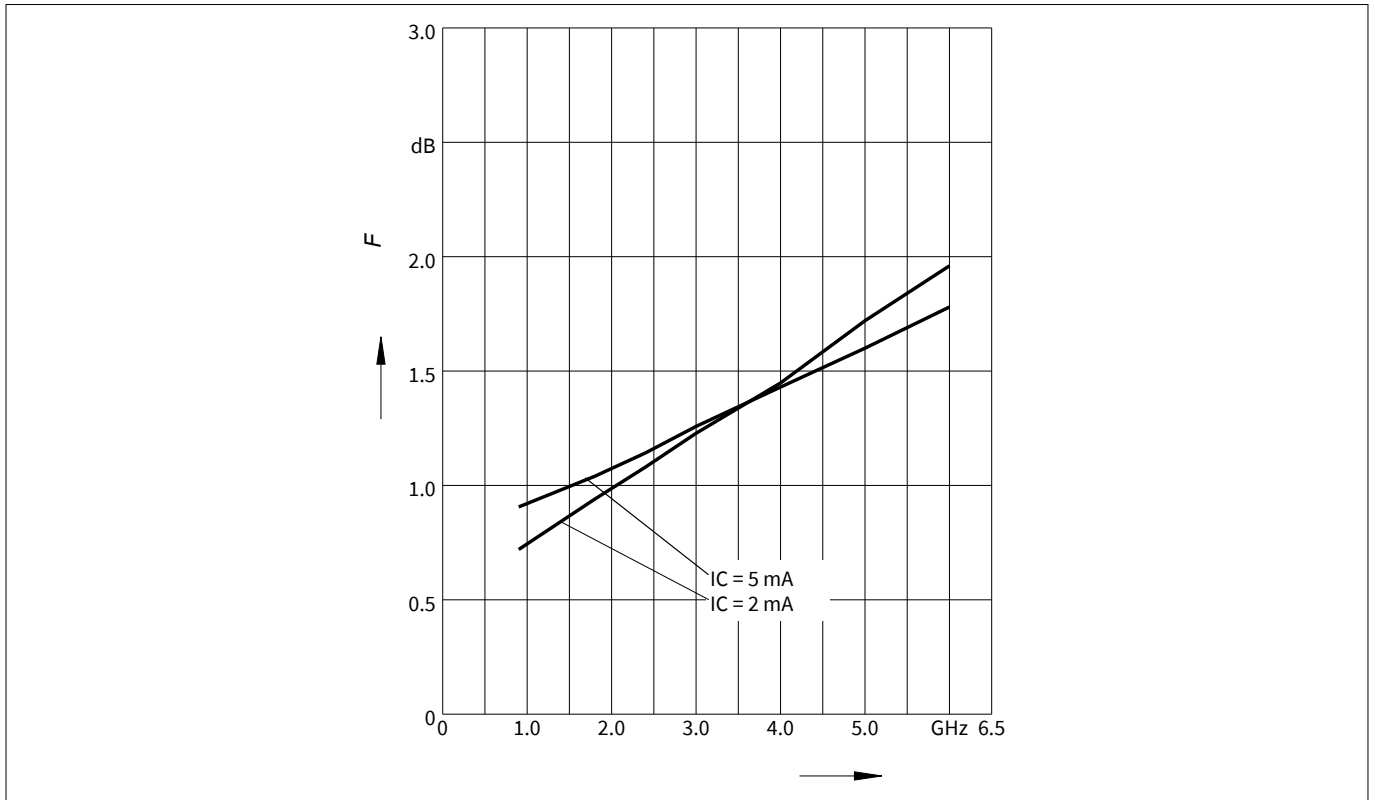

Figure 10 Noise figure $NF_{min} = f(f)$, $V_{CE} = 2\text{ V}$, $Z_S = Z_{S,opt}$, $I_C = 2 / 5\text{ mA}$

Electrical characteristics

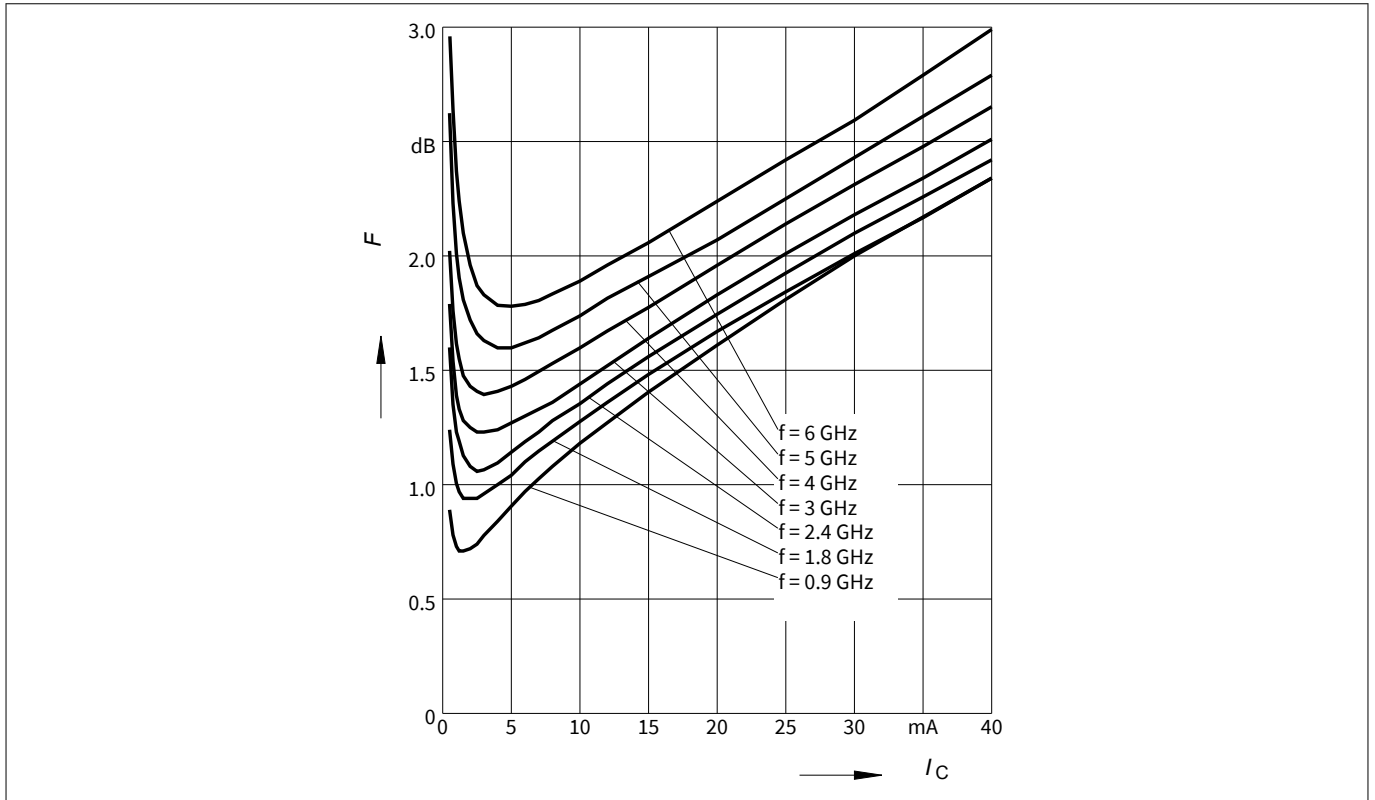

Figure 11 Noise figure $NF_{min} = f(I_C)$, $V_{CE} = 2\text{ V}$, $Z_S = Z_{S,opt}$, $f = \text{parameter in GHz}$

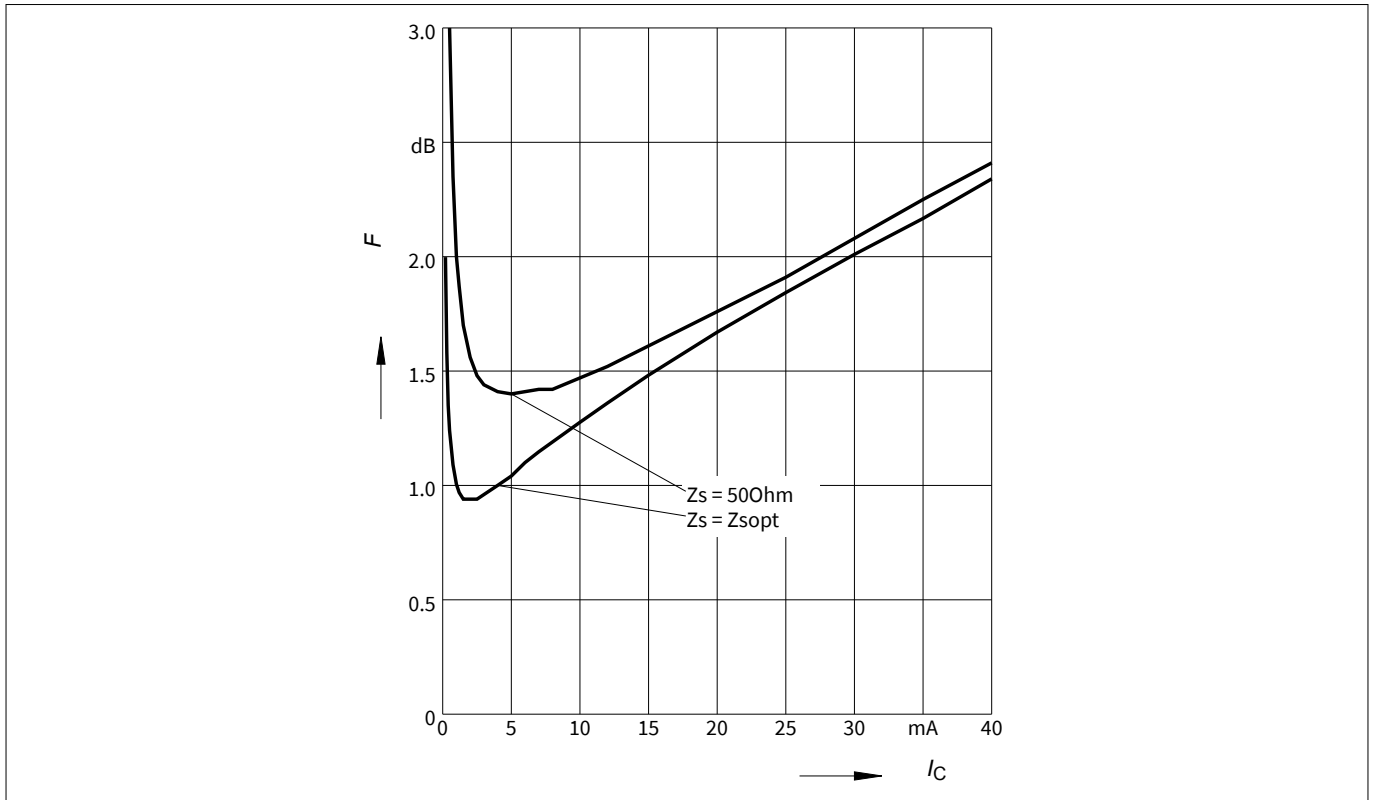

Figure 12 Noise figure $NF_{50} = f(I_C)$, $Z_S = 50\ \Omega$, $NF_{min} = f(I_C)$, $Z_S = Z_{S,opt}$, $V_{CE} = 2\text{ V}$, $f = 1.8\text{ GHz}$

Note: The curves shown in this chapter have been generated using typical devices but shall not be considered as a guarantee that all devices have identical characteristic curves. $T_A = 25\text{ }^\circ\text{C}$.

Package information SOT343

4 Package information SOT343

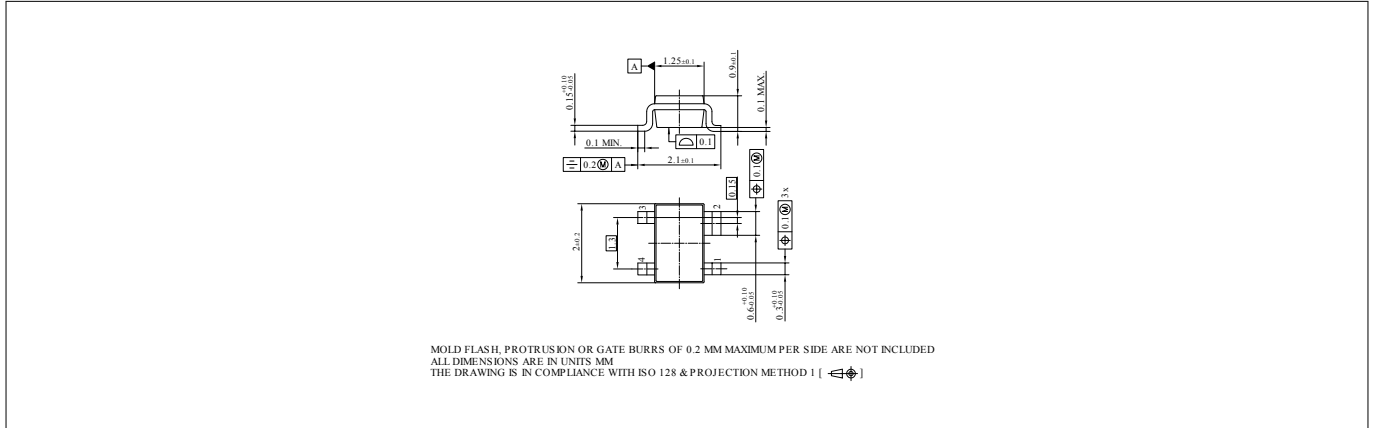

Figure 13 Package outline

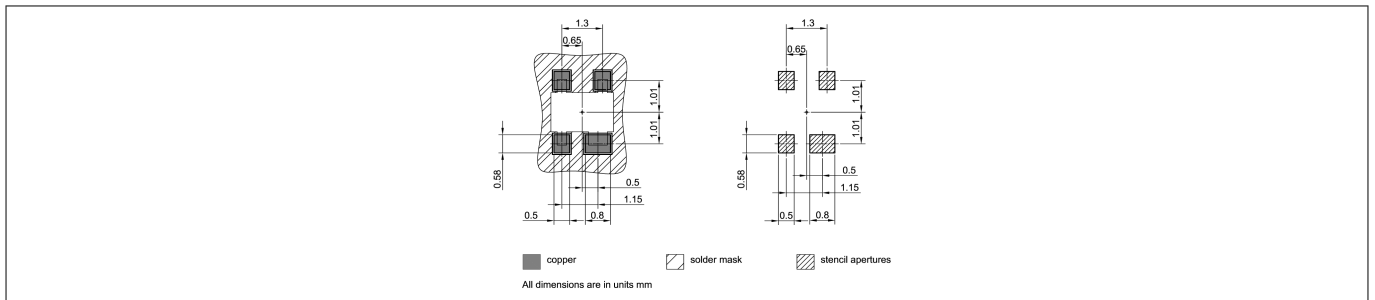

Figure 14 Foot print

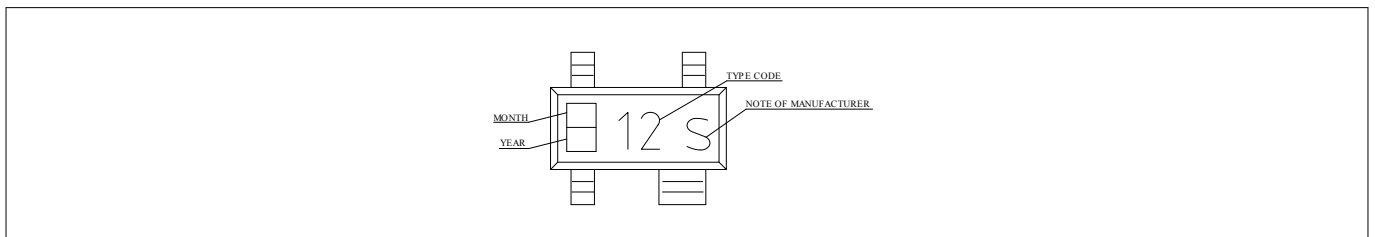

Figure 15 Marking layout example

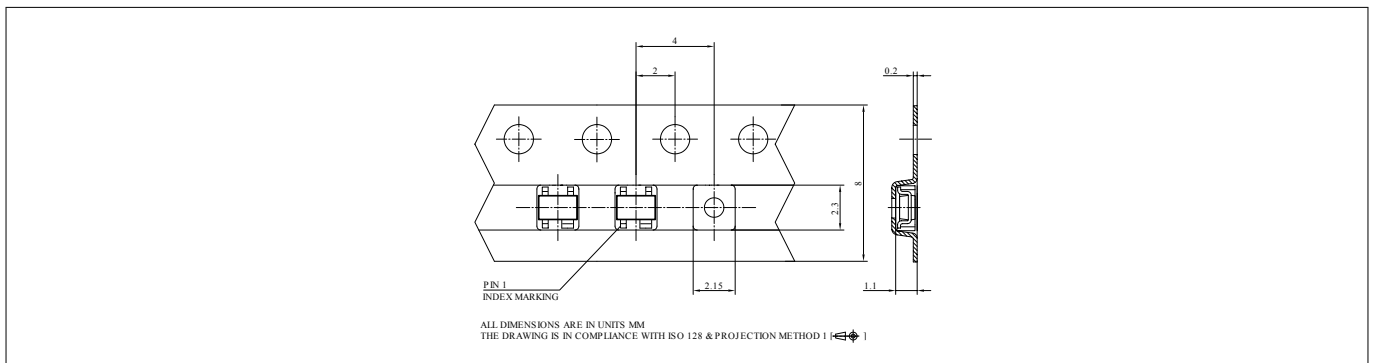

Figure 16 Tape dimensions

Revision history

Revision history

Document version	Date of release	Description of changes
Revision 2.0	2019-01-25	New datasheet layout.

Trademarks

All referenced product or service names and trademarks are the property of their respective owners.

Edition 2019-01-25

Published by

Infineon Technologies AG

81726 Munich, Germany

© 2019 Infineon Technologies AG

All Rights Reserved.

Do you have a question about any aspect of this document?

Email: erratum@infineon.com

Document reference

IFX-yis1525436477257

IMPORTANT NOTICE

The information given in this document shall in no event be regarded as a guarantee of conditions or characteristics ("Beschaffheitsgarantie").

With respect to any examples, hints or any typical values stated herein and/or any information regarding the application of the product, Infineon Technologies hereby disclaims any and all warranties and liabilities of any kind, including without limitation warranties of non-infringement of intellectual property rights of any third party.

In addition, any information given in this document is subject to customer's compliance with its obligations stated in this document and any applicable legal requirements, norms and standards concerning customer's products and any use of the product of Infineon Technologies in customer's applications.

The data contained in this document is exclusively intended for technically trained staff. It is the responsibility of customer's technical departments to evaluate the suitability of the product for the intended application and the completeness of the product information given in this document with respect to such application.

WARNINGS

Due to technical requirements products may contain dangerous substances. For information on the types in question please contact your nearest Infineon Technologies office.

Except as otherwise explicitly approved by Infineon Technologies in a written document signed by authorized representatives of Infineon Technologies, Infineon Technologies' products may not be used in any applications where a failure of the product or any consequences of the use thereof can reasonably be expected to result in personal injury