

Silicon Carbide Schottky Diode

IDW40G120C5B

5th Generation CoolSiC™ 1200 V SiC Schottky Diode

Final Datasheet

Rev. 2.2 2021-03-01

CoolSiC™ SiC Schottky Diode

Features:

- Revolutionary semiconductor material - Silicon Carbide
- No reverse recovery current / No forward recovery
- Temperature independent switching behavior
- Low forward voltage even at high operating temperature
- Tight forward voltage distribution
- Excellent thermal performance
- Extended surge current capability
- Specified dv/dt ruggedness
- Qualified according to JEDEC¹⁾ for target applications
- Pb-free lead plating; RoHS compliant

Benefits

- System efficiency improvement over Si diodes
- Enabling higher frequency / increased power density solutions
- System size/cost savings due to reduced heatsink requirements and smaller magnetics
- Reduced EMI
- Highest efficiency across the entire load range
- Robust diode operation during surge events
- High reliability
- RelatedLinks: www.infineon.com/sic

Applications

- Solar inverters
- Uninterruptable power supplies
- Motor drives
- Power Factor Correction

Package pin definitions

- Pin 1 – anode 1
- Pin 2 and backside – cathode
- Pin 3 – anode 2

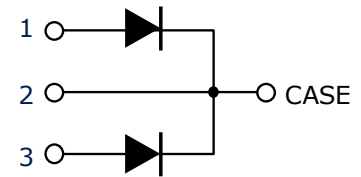

Key Performance and Package Parameters (leg/device)

Type	V _{DC}	I _F	Q _C	T _{j,max}	Marking	Package
IDW40G120C5B	1200V	20 / 40 A	101 / 202nC	175°C	D4012B5	PG-TO247-3

1) J-STD20 and JESD22

Table of Contents

Description.....	2
Table of Contents.....	3
Maximum ratings.....	4
Thermal Resistances	4
Electrical Characteristics.....	5
Electrical Characteristics diagram	6
Package Drawings	9
Revision History	10
Disclaimer.....	11

Maximum ratings

Parameter	Symbol	Value (leg/device)	Unit
Repetitive peak reverse voltage	V_{RRM}	1200	V
Continuous forward current for $R_{th(j-c,max)}$ $T_C = 148^\circ\text{C}$, $D=1$ $T_C = 135^\circ\text{C}$, $D=1$ $T_C = 25^\circ\text{C}$, $D=1$	I_F	20 / 40 25 / 51 55 / 110	A
Surge non-repetitive forward current, sine halfwave $T_C=25^\circ\text{C}$, $t_p=10\text{ms}$ $T_C=150^\circ\text{C}$, $t_p=10\text{ms}$	$I_{F,SM}$	145 / 290 140 / 280	A
Non-repetitive peak forward current $T_C = 25^\circ\text{C}$, $t_p=10 \mu\text{s}$	$I_{F,max}$	1575 / 3150	A
i^2t value $T_C = 25^\circ\text{C}$, $t_p=10 \text{ms}$ $T_C = 150^\circ\text{C}$, $t_p=10 \text{ms}$	$\int i^2 dt$	105 / 420 98 / 392	A ² s
Diode dv/dt ruggedness $V_R=0\dots960 \text{V}$	dv/dt	150	V/ns
Power dissipation for $R_{th(j-c,max)}$ $T_C = 25^\circ\text{C}$	P_{tot}	201 / 402	W
Operating and storage temperature	$T_j; T_{stg}$	-55...175	$^\circ\text{C}$
Soldering temperature, wavesoldering only allowed at leads 1.6mm (0.063 in.) from case for 10 s	T_{sold}	260	$^\circ\text{C}$
Mounting torque M3 and M4 screws	M	0.7	Nm

Thermal Resistances

Parameter	Symbol	Conditions	Value (leg/device)			Unit
			min.	typ.	max.	
Characteristic						
Diode thermal resistance, junction – case	$R_{th(j-c)}$		-	0.6/0.3	0.8/0.4	K/W
Thermal resistance, junction – ambient	$R_{th(j-a)}$	leaded	-	-	62	K/W

Electrical Characteristics
Static Characteristic, at T_j=25°C, unless otherwise specified

Parameter	Symbol	Conditions	Value (leg/device)			Unit
			min.	typ.	max.	
DC blocking voltage	V _{DC}	T _j = 25°C	1200	-	-	V
Diode forward voltage	V _F	I _F = 20/40 A, T _j =25°C	-	1.4	1.65	V
		I _F = 20/40 A, T _j =150°C	-	1.7	2.30	
Reverse current	I _R	V _R =1200 V, T _j =25°C		12 / 23	166 / 332	μA
		V _R =1200 V, T _j =150°C		59 / 118	850 / 1700	

Dynamic Characteristics, at T_j=25°C, unless otherwise specified

Parameter	Symbol	Conditions	Value (leg/device)			Unit
			min.	typ.	max.	
Total capacitive charge	Q _C	V _R = 800 V, T _j =150°C & 25°C $Q_C = \int_0^{V_R} C(V) dV$	-	101 / 202	-	nC
Total Capacitance	C	V _R =1 V, f=1 MHz	-	1296/2592	-	pF
		V _R =400 V, f=1 MHz	-	92 / 183	-	
		V _R =800 V, f=1 MHz	-	73 / 146	-	

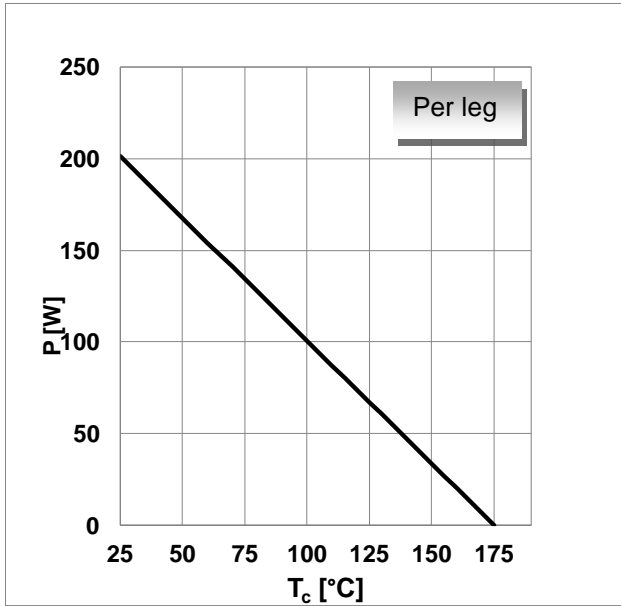

Figure 1. Power dissipation per leg as function of case temperature, $P_{tot}=f(T_c)$, $R_{th(j-c),max}$

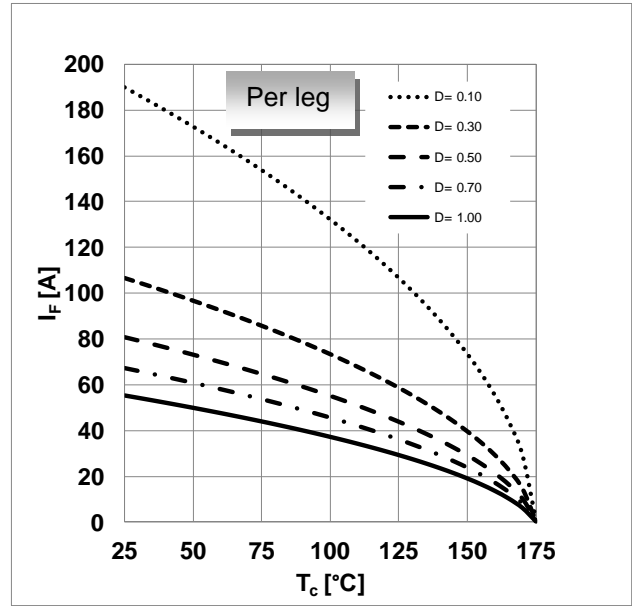

Figure 2. Diode forward current per leg as function of temperature, parameter: $T_j \leq 175^\circ\text{C}$, $R_{th(j-c),max}$, D =duty cycle, V_{th} , R_{diff} @ $T_j=175^\circ\text{C}$

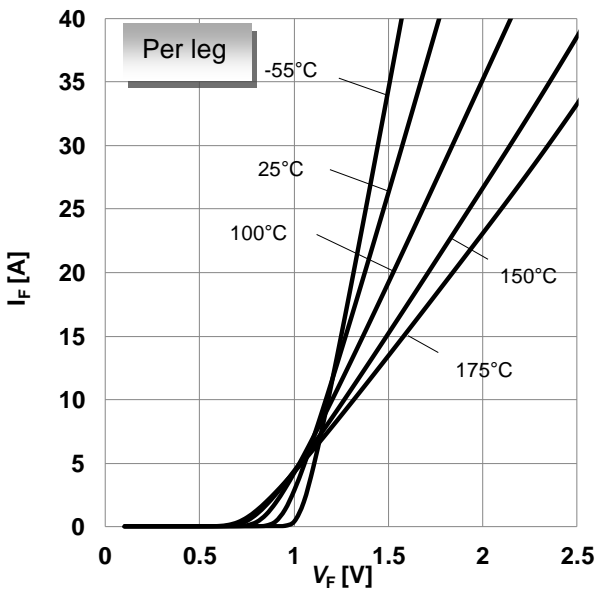

Figure 3. Typical forward characteristics per leg, $I_F=f(V_F)$, $t_p=10\ \mu\text{s}$, parameter: T_j

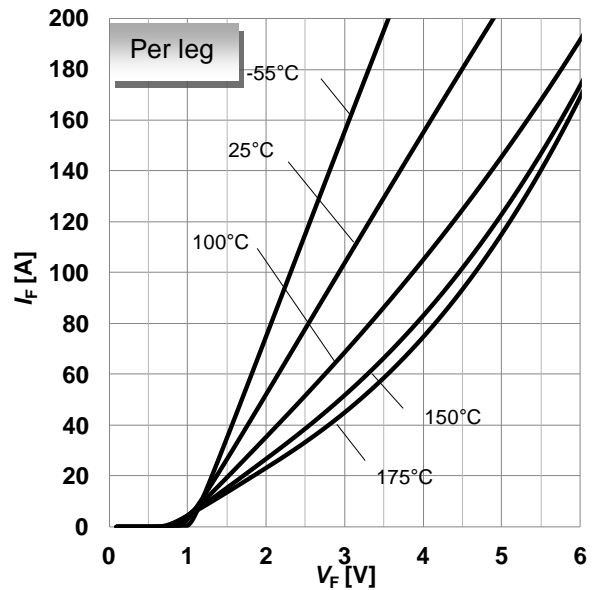

Figure 4. Typical forward characteristics in surge current per leg, $I_F=f(V_F)$, $t_p=10\ \mu\text{s}$, parameter: T_j

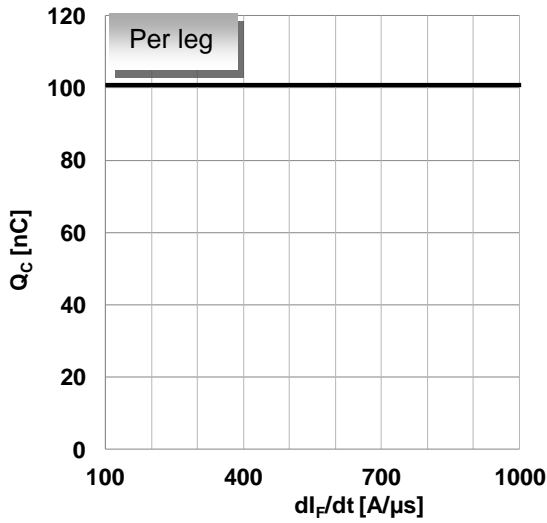

Figure 5. Typical capacitive charge per leg as function of current slope¹, $Q_c=f(di/dt)$, $T_j=150^\circ\text{C}$
 1) guaranteed by design.

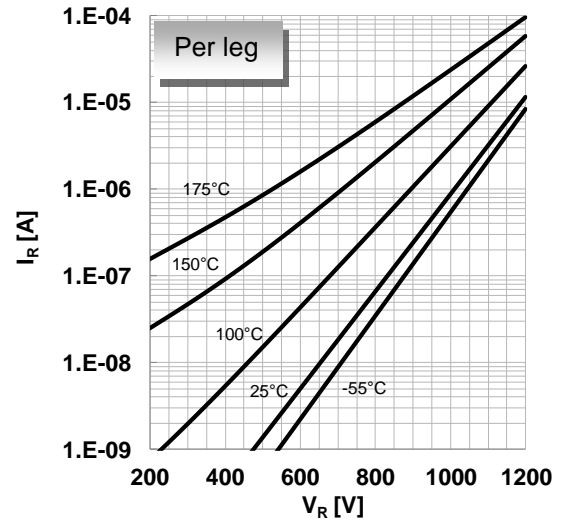

Figure 6. Typical reverse characteristics per leg, $I_R=f(V_R)$, parameter: T_j

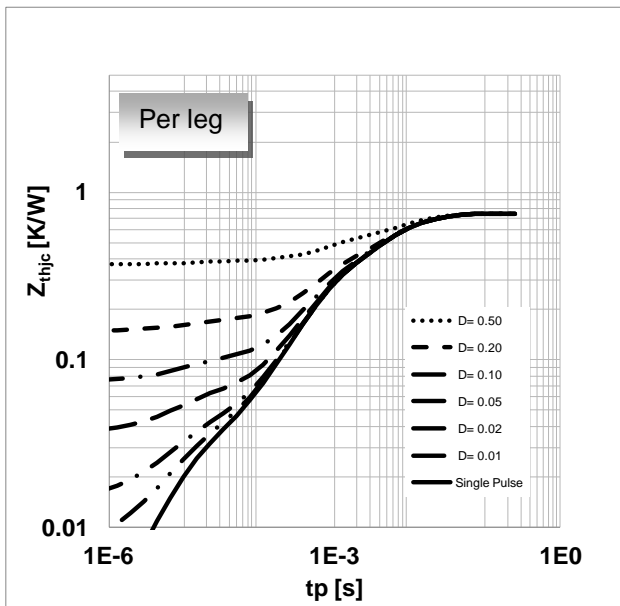

Figure 7. Max. transient thermal impedance per leg, $Z_{th,j-c}=f(t_p)$, parameter: $D=t_p/T$

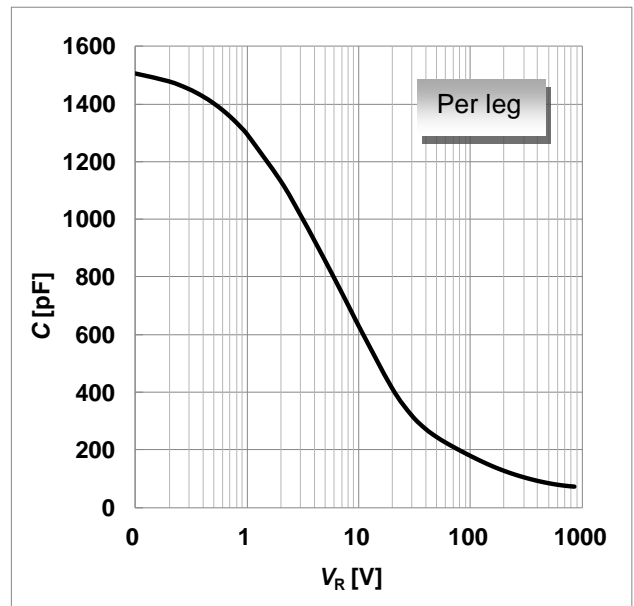

Figure 8. Typical capacitance per leg as function of reverse voltage, $C=f(V_R)$; $T_j=25^\circ\text{C}$; $f=1\text{ MHz}$

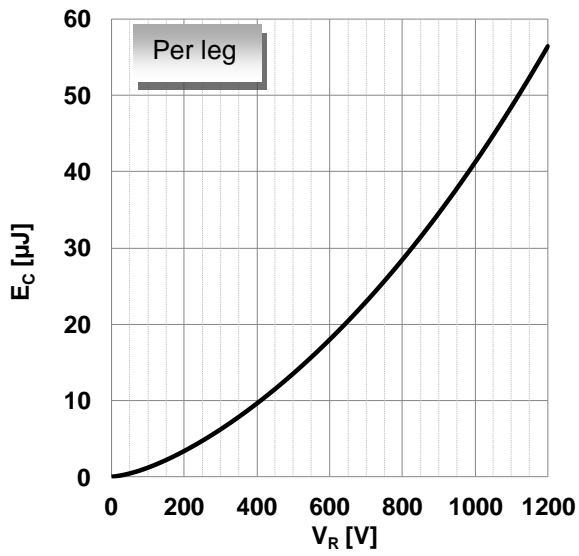
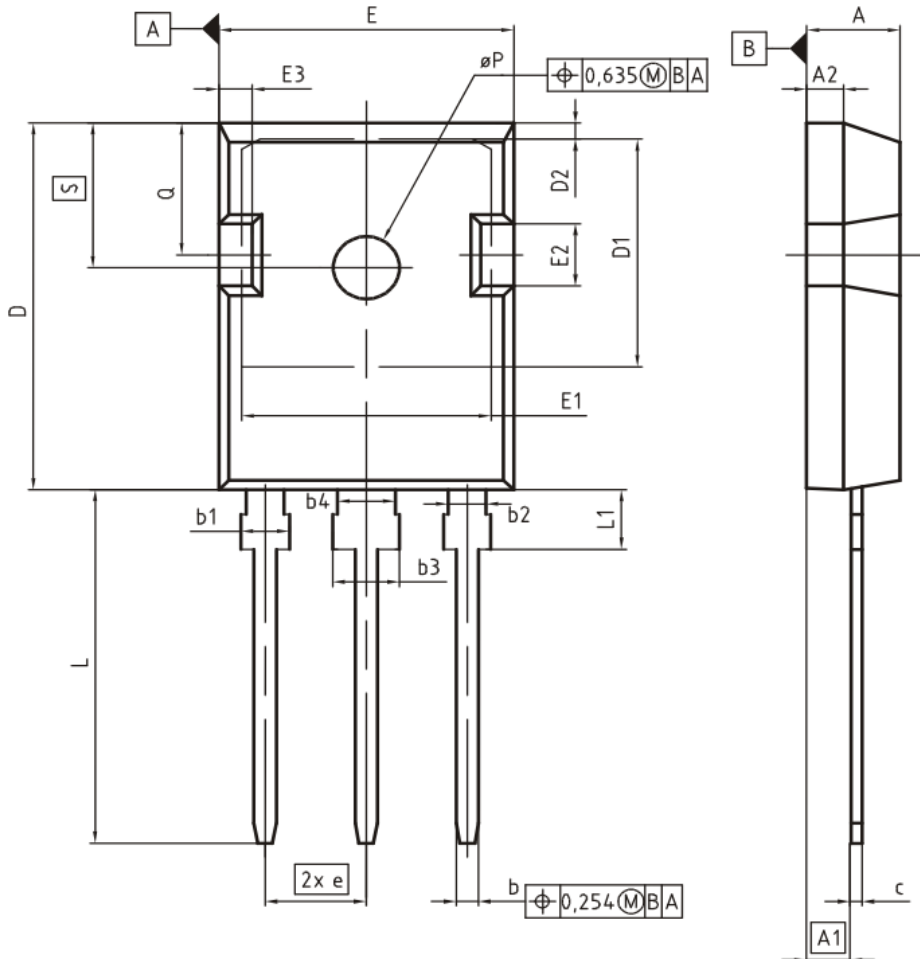

Figure 9. Typical capacitively stored energy as function of reverse voltage, per leg, $E_C=f(V_R)$

PG-TO247-3



DIM	MILLIMETERS		INCHES	
	MIN	MAX	MIN	MAX
A	4.83	5.21	0.190	0.205
A1	2.27	2.54	0.089	0.100
A2	1.85	2.16	0.073	0.085
b	1.07	1.33	0.042	0.052
b1	1.90	2.41	0.075	0.095
b2	1.90	2.16	0.075	0.085
b3	2.87	3.38	0.113	0.133
b4	2.87	3.13	0.113	0.123
c	0.55	0.68	0.022	0.027
D	20.80	21.10	0.819	0.831
D1	16.25	17.65	0.640	0.695
D2	0.95	1.35	0.037	0.053
E	15.70	16.13	0.618	0.635
E1	13.10	14.15	0.516	0.557
E2	3.68	5.10	0.145	0.201
E3	1.00	2.60	0.039	0.102
e	5.44 (BSC)		0.214 (BSC)	
N	3		3	
L	19.80	20.32	0.780	0.800
L1	4.10	4.47	0.161	0.176
øP	3.50	3.70	0.138	0.146
Q	5.49	6.00	0.216	0.236
S	6.04	6.30	0.238	0.248

DOCUMENT NO.
Z8B00003327

SCALE

EUROPEAN PROJECTION

ISSUE DATE
09-07-2010

REVISION
05

Revision HistoryIDW40G120C5B

Revision: 2021-03-01, Rev. 2.2Previous Revision:

Revision	Date	Subjects (major changes since last version)
2.0	2014-06-10	Final data sheet
2.1	2017-07-21	Editorial Changes
2.2	2021-03-01	Increased dv/dt ruggedness

We Listen to Your Comments

Any information within this document that you feel is wrong, unclear or missing at all?

Your feedback will help us to continuously improve the quality of this document.

Please send your proposal (including a reference to this document) to: erratum@infineon.com

Published by
Infineon Technologies AG
81726 München, Germany
© Infineon Technologies AG 2021.
All Rights Reserved.

IMPORTANT NOTICE

The information given in this document shall in no event be regarded as a guarantee of conditions or characteristics ("Beschaffenheitsgarantie"). With respect to any examples, hints or any typical values stated herein and/or any information regarding the application of the product, Infineon Technologies hereby disclaims any and all warranties and liabilities of any kind, including without limitation warranties of non-infringement of intellectual property rights of any third party.

In addition, any information given in this document is subject to customer's compliance with its obligations stated in this document and any applicable legal requirements, norms and standards concerning customer's products and any use of the product of Infineon Technologies in customer's applications.

The data contained in this document is exclusively intended for technically trained staff. It is the responsibility of customer's technical departments to evaluate the suitability of the product for the intended application and the completeness of the product information given in this document with respect to such application.

For further information on the product, technology, delivery terms and conditions and prices please contact your nearest Infineon Technologies office (www.infineon.com).

Please note that this product is not qualified according to the AEC Q100 or AEC Q101 documents of the Automotive Electronics Council.

WARNINGS

Due to technical requirements products may contain dangerous substances. For information on the types in question please contact your nearest Infineon Technologies office.

Except as otherwise explicitly approved by Infineon Technologies in a written document signed by authorized representatives of Infineon Technologies, Infineon Technologies' products may not be used in any applications where a failure of the product or any consequences of the use thereof can reasonably be expected to result in personal injury.