

**DISPLAY Elektronik GmbH**

# DATA SHEET

**LCD MODULE**

**DEM 240128D1 FGH-PW  
(A-TOUCH)**

*Product Specification*

*Version: 1*

**15.08.2017**



# CONTENTS

1. FUNCTIONS & FEATURES.....	2
2. MODULE ARTWORK.....	2
3. EXTERNAL DIMENSIONS .....	3
4. BLOCK DIAGRAM.....	4
5. PIN ASSIGNMENT.....	4
6. POWER SUPPLY.....	5
7. ABSOLUTE MAXIMUM RATINGS( VSS=0V, TA=25°C).....	5
8. PCB DRAWING AND DESCRIPTION .....	5
9. BACKLIGHT ELECTRICAL/OPTICAL SPECIFICATIONS.....	8
10. TOUCH PANEL DRAWING.....	9
11. ELECTRICAL CHARACTERISTICS .....	10
12. COMMAND TABLE.....	12
13. QUALITY DESCRIPTION.....	14
14. MODULE ACCEPT QUALITY LEVEL (AQL).....	15
15. RELIABILITY TEST .....	15
16. LCD MODULES HANDLING PRECAUTIONS.....	16
17. OTHERS .....	16

**1. FUNCTIONS & FEATURES**

MODULE NAME	LCD TYPE
DEM 240128D1 FGH-PW (A-TOUCH)	FSTN Transflective Positive Mode

- Glass Thickness : 1.1 mm
- Viewing Direction : 6 O'clock
- Driving Scheme : 1/128 Duty, 1/12 Bias
- Power Supply for logic : 5.0 Volt (typ.)
- Backlight Color : LED, White
- Display Content : 240 x 128 Dots
- $V_{LCD}$  ( $V_{LCD}=V_{DD}-V_0$ ) : 20.0 Volt (typ.)
- IC Driver : NT7086
- IC Controller : UCi6963
- Touch panel : RTP

**2. MODULE ARTWORK**

- Module Size : 144.00 x 104.00 x 17.10 mm
- Viewing Area : 114.00 x 64.00 mm
- Active Area : 107.95 x 57.55 mm
- Dot Pitch : 0.45 x 0.45 mm
- Dot Size : 0.40 x 0.40 mm
- Dot Gap : 0.05 mm

**3. EXTERNAL DIMENSIONS**

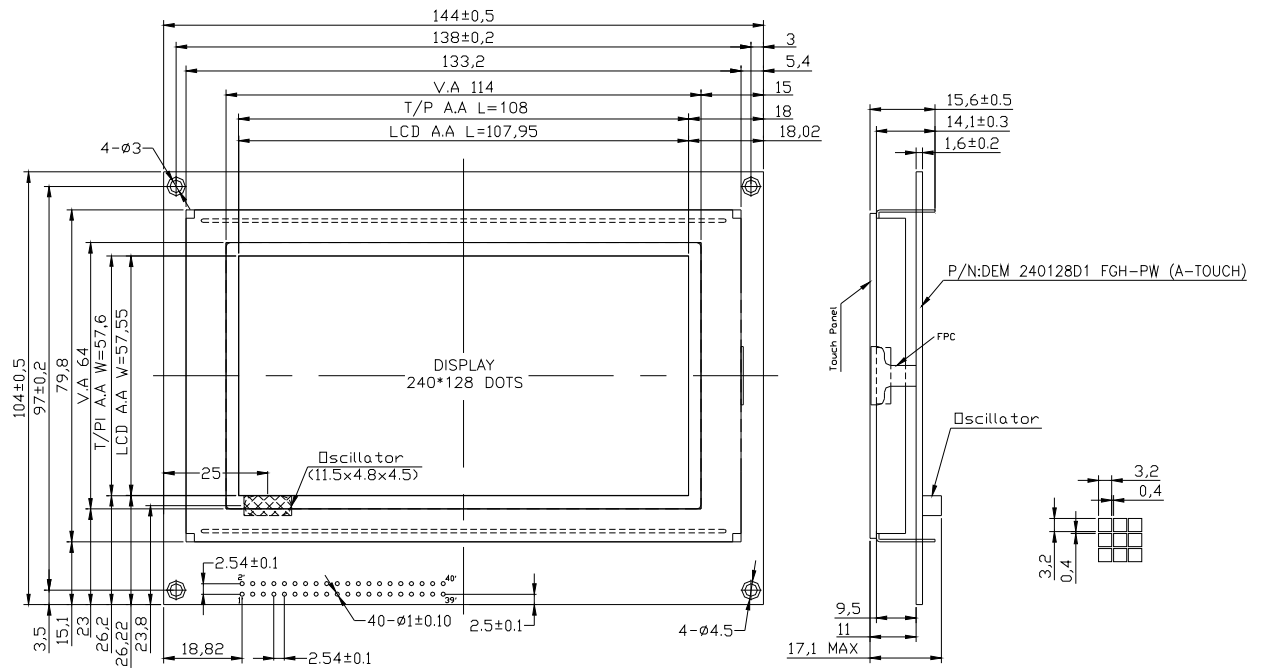

Remarks:

- 1, Unmarked Tolerance  $\pm 0.30$
- 2, All material comply with RoHs.

**4. BLOCK DIAGRAM**

**4.1 Block Diagram of LCD Module**

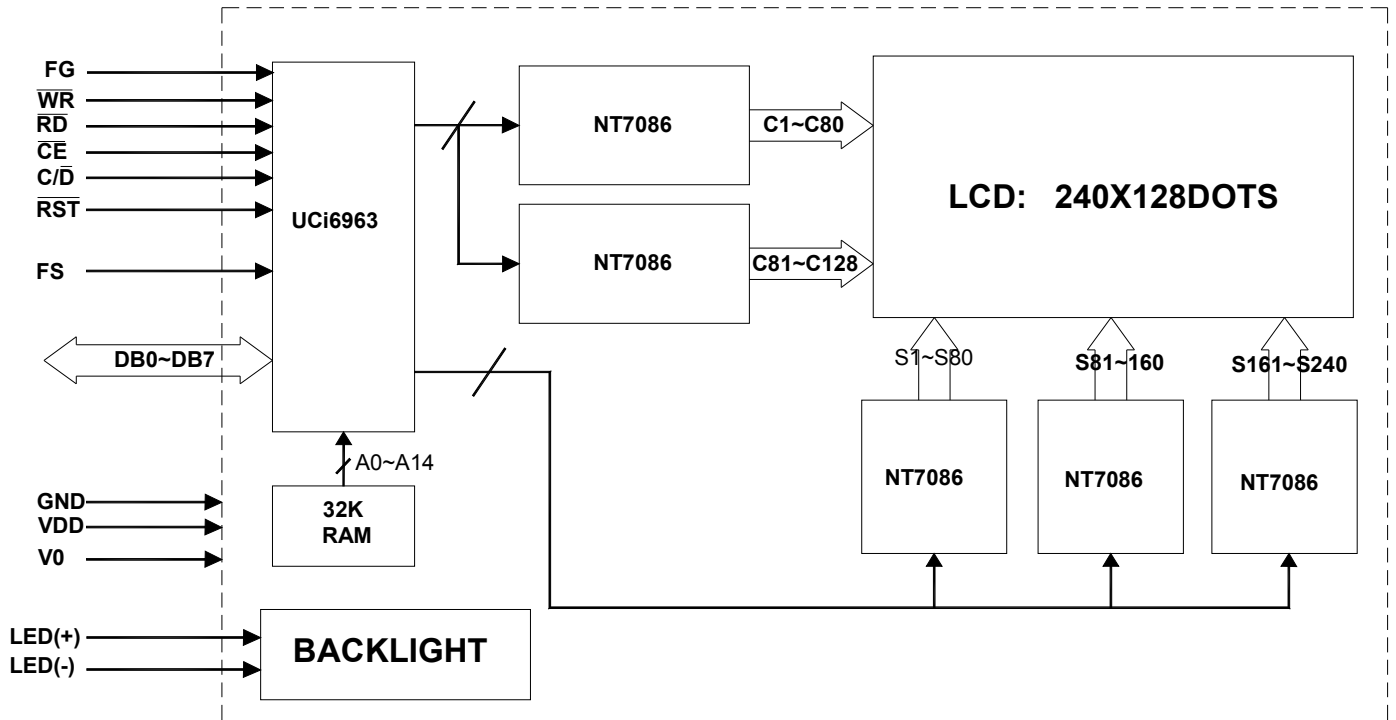

**4.2 Analog Touch Screen Auto-Scanning Block Diagram**

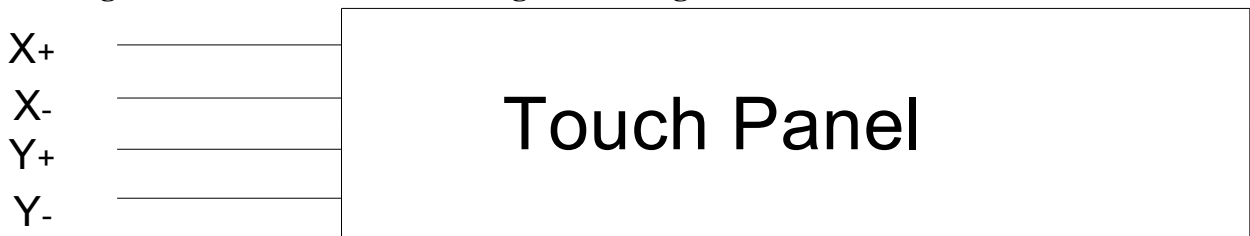

**5. PIN ASSIGNMENT**

NO.	SYMBOL	FUNCTION
-----	--------	----------

1	FG	Frame ground
2	Y-	Y- Position Input
3	VSS	Ground(0V)
4	X+	X+ Position Input
5	VDD	Power supply for logic(+5V)
6	Y+	Y+ Position Input
7	V0	Power supply for LCD drive(-15.5V)
8	X-	X- Position Input
9	/WR	Write Command or data to module when “L”
10,12,14,16, 18,20,22,24, 26,28,30,32, 34,36,38,40	NC	No connection.
11	/RD	Read Command or data from module when “L”
13	/CE	Enable LCD controller when “L”
15	C//D	Command/data select. “H” for command read/write. “L” for data read/write
17	/RST	LCD Controller reset. Controller initialize and DB00-DB07 are set to be high impedance when/RST is “L”
19,21,23,25, 27,29,31,33,	DB0 ~ DB7	LCD data input/output. DB0(pin19) is LSB and DB7(pin33) is MSB.
35	FS	Font select. “H” for 6x8 font and “L” for 8x8 font
37	LED+(A)	Please refer to item 8 PCB drawing and description
39	LED-(K)	

**6. POWER SUPPLY**

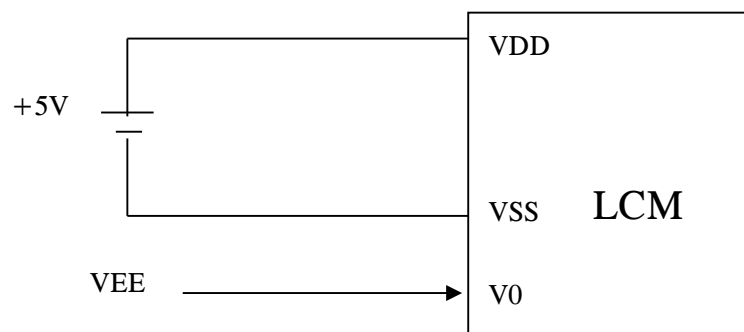

**7. ABSOLUTE MAXIMUM RATINGS (V<sub>SS</sub>=0V, T<sub>a</sub>=25°C)**

PARAMETER	SYMBOL	RATING	UNIT
Supply Voltage (Logic)	V <sub>DD</sub>	-0.3 to 7.0	V
Input voltage	V <sub>IN</sub>	-0.3 to V <sub>DD</sub> +0.3	V
Operating Temperature	T <sub>opr</sub>	-20 to +70	°C
Storage Temperature	T <sub>stg</sub>	-25 to +75	°C

**8. PCB DRAWING AND DESCRIPTION**

**8.1. PCB DRAWING**





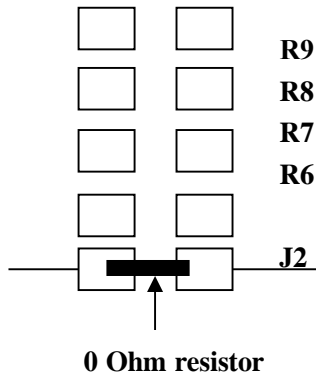

8-3-2. The 37 pin is the anode and the 39 pin is the cathode as following.

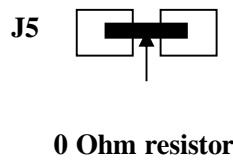
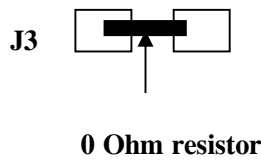

8-3-3. The 37 pin is cathode and the 39 pin is anode as following.

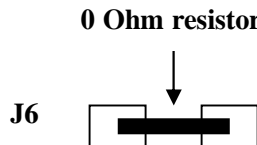
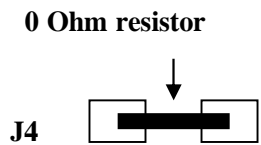

8-3-4. The metal-bezel is on ground as following

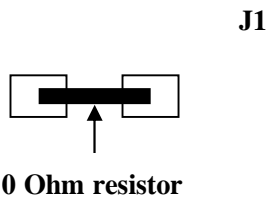

8-3-5. The holes are on ground as following

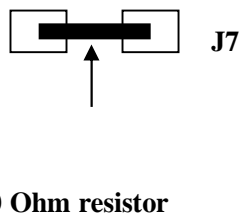

**9. BACKLIGHT ELECTRICAL/OPTICAL SPECIFICATIONS**

**ELECTRICAL–OPTICAL CHARACTERISTICS**

Item	Symbol	min.	typ.	max.	Unit	Condition
Forward Voltage	Vf	2.9	3.2	3.4	V	If= 45 mA
Reverse Current	Ir		30		$\mu A$	Vr= 0.8 V
Luminance	Lv	165	220		cd/m <sup>2</sup>	If= 45 mA

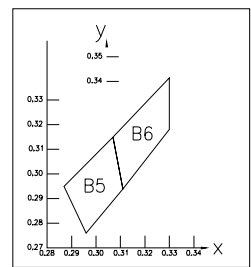
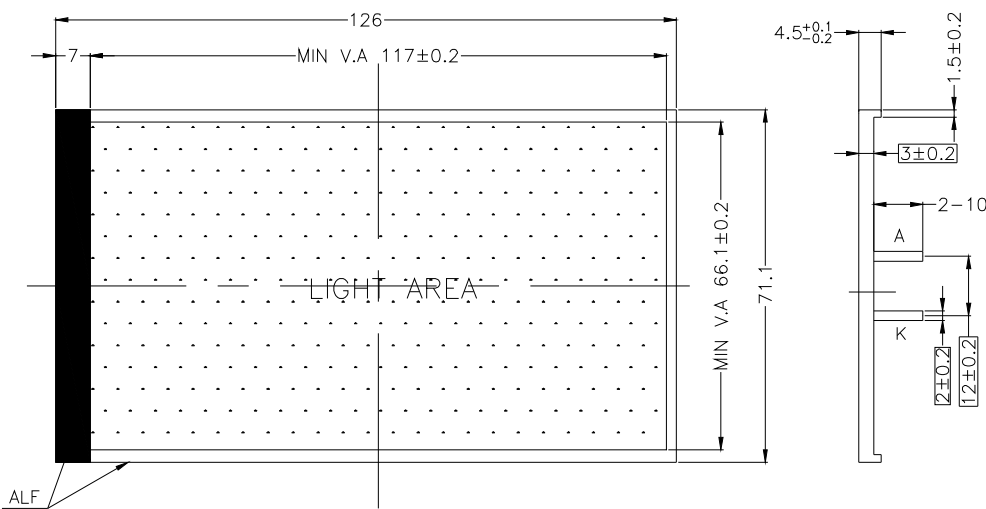

**CHROMATICS COORDINATES**

x	0.296	0.287	0.330	0.330
y	0.276	0.295	0.339	0.318

**TOLERANCE IS ±0.01**



- Remarks:  
 1.Unmarked tolerance is ±0.3  
 2.Color:white  
 3.All materials comply with RoHs

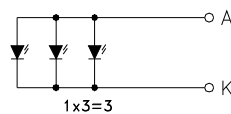

**10. TOUCH PANEL DRAWING**

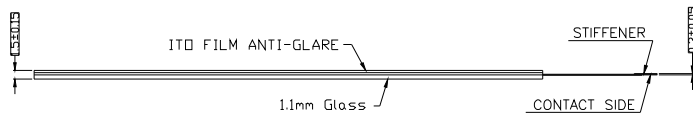
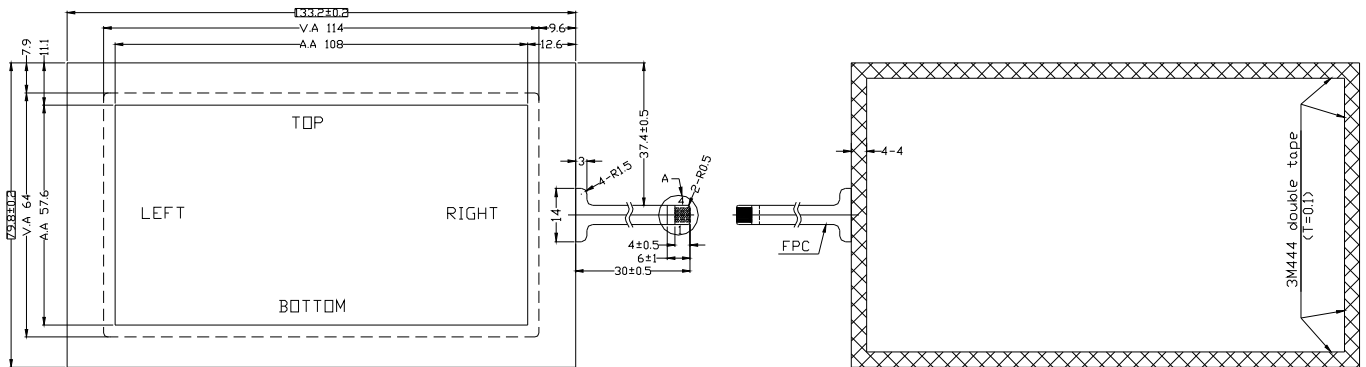

TOUCH PANEL	
No	SYMBOL
1	BOTTOM
2	RIGHT
3	TOP
4	LEFT

Characteristics:

- 1, Operating voltage: DC5V
- 2, Operating pressure: 30~70g
- 3, Linearity: ±1.5% or less
- 4, Operating temperature: -10°C~+50°C
- 5, Storage temperature: -20°C~+70°C
- 6, Humidity: <90%RH
- 7, Transmittance: 75% or more
- 8, Connector: FPC
- 9, Film Type: Anti\_Glare
- 10, Lifetime: 1000000 times
- 11, Response time: <10ms

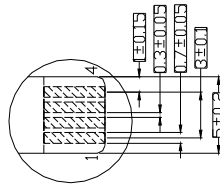

Detail A

Remarks:

- 1, Unmarked tolerance is ±0.3,
- 2, The material comply with RoHS.

**11. ELECTRICAL CHARACTERISTICS**

**11.1 DC Characteristics**

Parameter	Symbol	Conditions	Min.	Typ.	Max.	Units
Supply Voltage (Logic)	V <sub>DD</sub>	-	4.7	5.0	5.3	V
High Level Input Voltage	V <sub>IH</sub>	-	0.8V <sub>DD</sub>	-	V <sub>DD</sub>	V
Low Level Input Voltage	V <sub>IL</sub>	-	0	-	0.2 V <sub>DD</sub>	V
High Level Output Voltage	V <sub>OH</sub>		V <sub>DD</sub> -0.3	-	V <sub>DD</sub>	V
Low Level Output Voltage	V <sub>OL</sub>		0	-	0.3	V
Current Consumption(Operating)	I <sub>DD(1)</sub>	V <sub>DD</sub> =5.0V f <sub>OSC</sub> = 4.0 MHz	-	3.0	5	mA
Current Consumption(Halt)	I <sub>DD(2)</sub>	V <sub>DD</sub> =5.0V		1	2	uA

**11.2 AC Characteristics**

Parameter	Symbol	Min.	Max.	Units
C/D Setup Time	t <sub>CDS</sub>	100	-	ns
C/D Hold Time	t <sub>CDH</sub>	10	-	ns
CE, RD, WR Pulse Width	t <sub>CE</sub> , t <sub>RD</sub> , t <sub>WR</sub>	80	-	ns
Data Setup Time	t <sub>DS</sub>	80	-	ns
Data Hold Time	t <sub>DH</sub>	40	-	ns
Access Time	t <sub>ACC</sub>	-	150	ns
Output Hold Time	t <sub>OH</sub>	10	50	ns

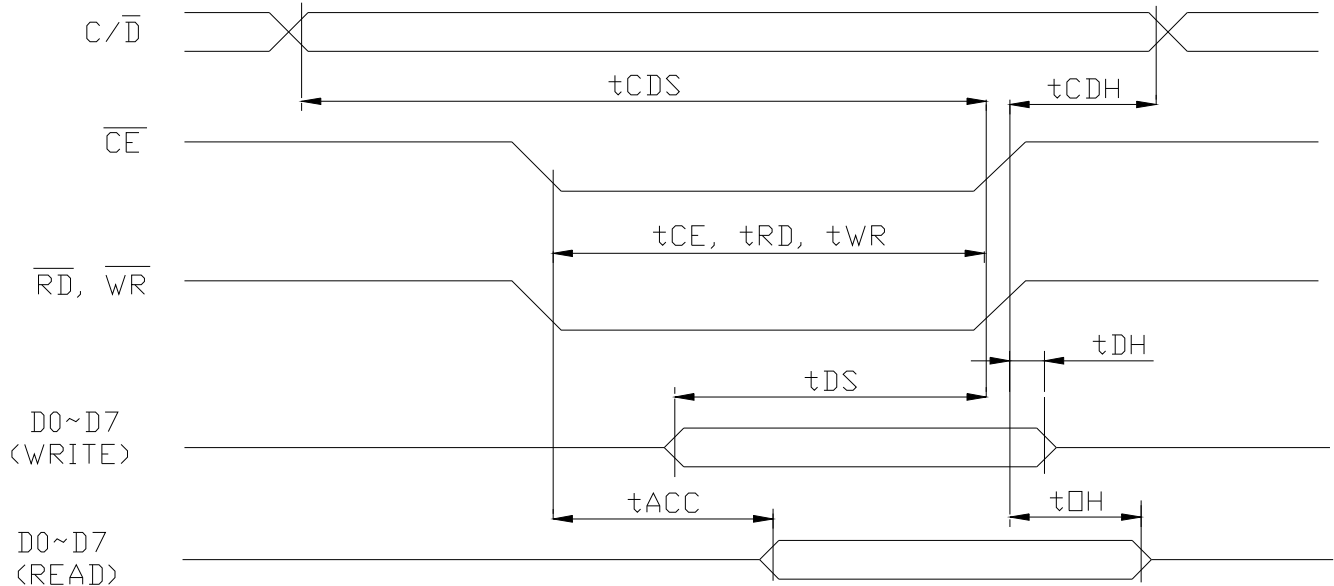

**11.3 Power Supply ON/OFF Sequence**

● ON Sequence

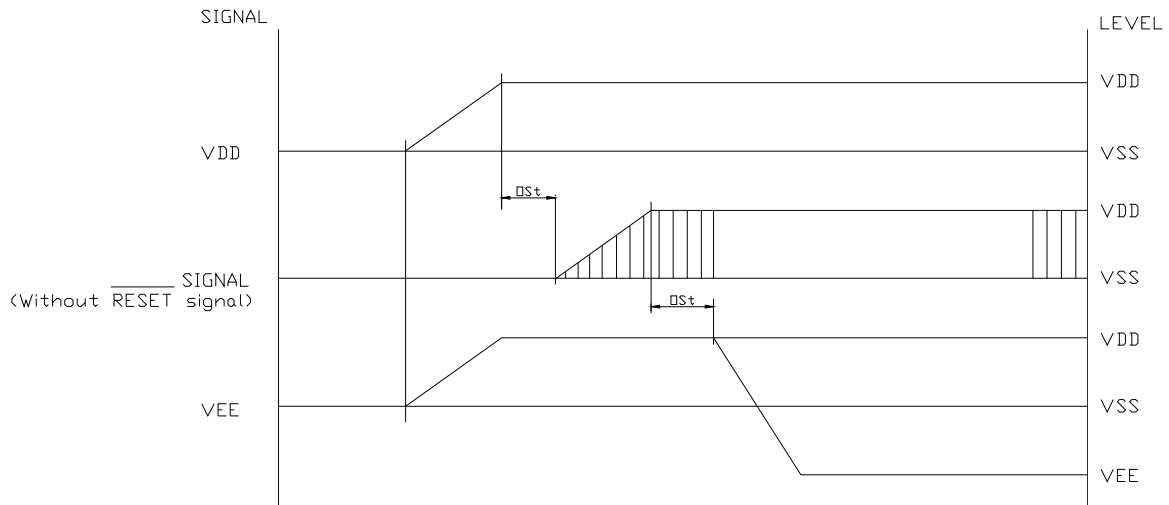

● OFF Sequence

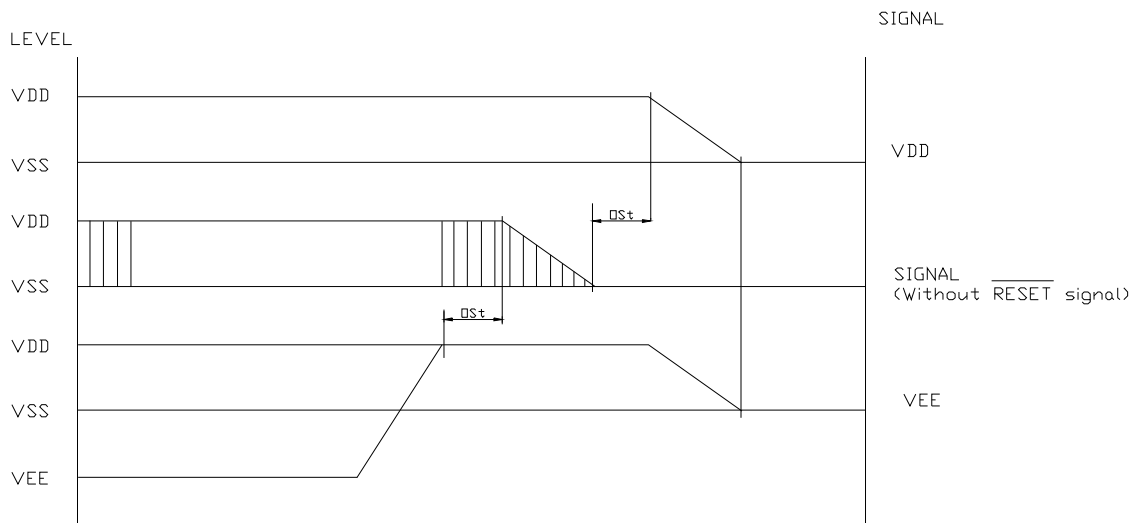

● Reset Sequence

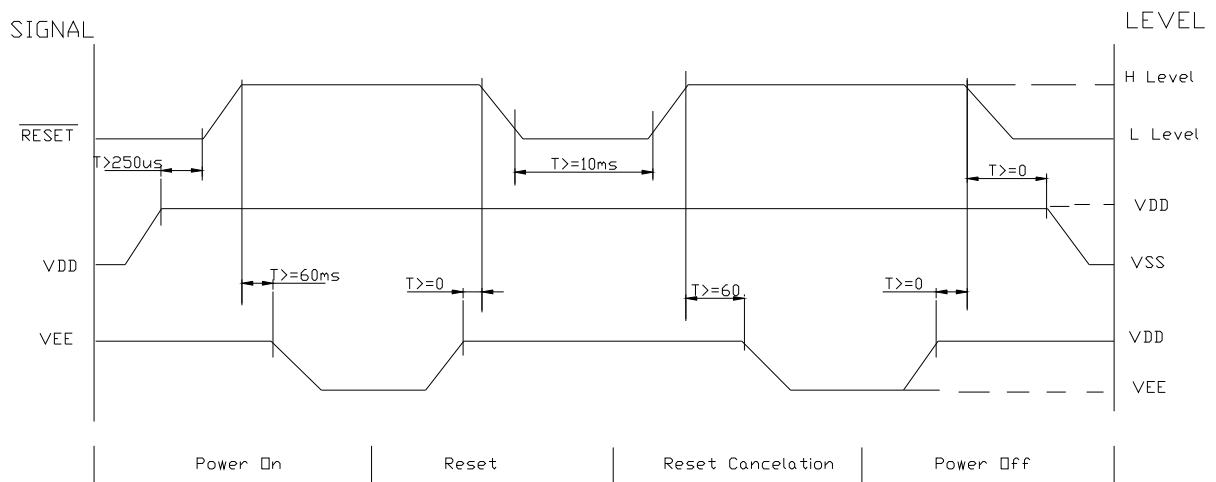

Please maintain the above sequence when turn on and off the power supply of the module.

If VEE is supplied to the module while internal alternate signal for LCD driving (M) is unstable or RESET is active, DC component will be supplied to the LCD panel. This may cause damage to the LCD module.

12. COMMAND TABLE

C/D: 1: Command / 0: Data

W/R: 0: Write Cycle / 1: Read Cycle

D7-D0: -: Don't Care / #: Valid data

No.	Command	C/D	W/R	D7	D6	D5	D4	D3	D2	D1	D0	Action	Value
1.	Set Cursor Pointer	1	0	0	0	1	0	0	0	0	1		21h
		0	0	#	#	#	#	#	#	#	#	Set X address	
		0	0	#	#	#	#	#	#	#	#	Set Y address	
2.	Set Offset Register	1	0	0	0	1	0	0	0	1	0		22h
		0	0	#	#	#	#	#	#	#	#	Data	
		0	0	0	0	0	0	0	0	0	0	0	
3.	Set Address Pointer	1	0	0	0	1	0	0	0	1	0		24h
		0	0	#	#	#	#	#	#	#	#	Low address	
		0	0	#	#	#	#	#	#	#	#	High address	
4.	Set Text Home Addr.	1	0	0	1	0	0	0	0	0	0		40h
		0	0	#	#	#	#	#	#	#	#	Low address	
		0	0	#	#	#	#	#	#	#	#	High address	
5.	Set Text Area	1	0	0	1	0	0	0	0	0	1		41h
		0	0	#	#	#	#	#	#	#	#	Columns	
		0	0	0	0	0	0	0	0	0	0	0	
6.	Set Graphic Home Addr.	1	0	0	1	0	0	0	0	0	1		42h
		0	0	#	#	#	#	#	#	#	#	Low address	
		0	0	#	#	#	#	#	#	#	#	High address	
7.	Set Graphic Area	1	0	0	1	0	0	0	0	1	1		43h
		0	0	#	#	#	#	#	#	#	#	Columns	
		0	0	0	0	0	0	0	0	0	0	0	
8.	OR mode	1	0	1	0	0	0	-	0	0	0		8xh
9.	EXOR mode	1	0	1	0	0	0	-	0	0	1		
10.	AND mode	1	0	1	0	0	0	-	0	1	1		
11.	Text Attribute mode	1	0	1	0	0	0	-	1	0	0		
		0	0	-	-	-	-	#	#	#	#		
12.	Internal CG ROM mode	1	0	1	0	0	0	0	-	-	-		
13.	External CG RAM mode	1	0	1	0	0	0	1	-	-	-		
14.	Display Mode	1	0	1	0	0	1	#	#	#	#	Switch Graphic/Text/Cursor/Blink ON/OFF	9xh
15.	Cursor Pattern Select	1	0	1	0	1	0	0	#	#	#	Set cursor: 1~8-line	Axh
16.	Data-write and Increase ADP	1	0	1	1	0	0	0	0	0	0		C0h
		0	0	#	#	#	#	#	#	#	#	Data	
17.	Data-read and Increase ADP	1	1	1	1	0	0	0	0	0	1		C1h
18.	Data-write and Decrease ADP	1	0	1	1	0	0	0	0	0	1		C2h
		0	0	#	#	#	#	#	#	#	#	Data	
19.	Data-read and Decrease ADP	1	1	1	1	0	0	0	0	1	1		C3h
20.	Data-write and Non-variable ADP	1	0	1	1	0	0	0	1	0	0		C4h
		0	0	#	#	#	#	#	#	#	#	Data	
21.	Data-read and Non-variable ADP	1	1	1	1	0	0	0	1	0	1		C5h
22.	Set Data Auto Write	1	0	1	0	1	1	0	0	0	0		B0h
23.	Set Data Auto Read	1	0	1	0	1	1	0	0	0	1		B1h
24.	Auto Reset	1	0	1	0	1	1	0	0	1	0		B2h
25.	Screen Peek	1	0	1	1	1	0	0	0	0	0		E0h
26.	Screen Copy	1	0	1	1	1	0	1	0	0	0		E8h
27.	Bit Set/Reset	1	0	1	1	1	1	#	#	#	#	Set/Reset Bit 0~7	Fxh
28.	Whole Screen Reverse (Triple-byte command)	1	0	1	1	0	1	0	0	0	0		D0h
		0	0	-	-	-	-	-	-	-	#	0: Normal      1: Reverse	
		0	0	-	-	-	-	-	-	-	-	(Don't Care)	

No.	Command	C/D	W/R	D7	D6	D5	D4	D3	D2	D1	D0	Action	Value	
29.	Blink Time (Triple-byte command)	1	0	0	1	0	1	0	0	0	0		50h	
		0	0	-	-	-	-	-	#	#	#	000b: 0.066s    100b: 1s 001b: 0.25s    101b: 1.25s <b>010b: 0.5s</b> 110b: 1.5s 011b: 1.75s    111b: 2s	010b	
		0	0	-	-	-	-	-	-	-	-	-	(Don't Care)	
30.	Cursor Auto Moving (Triple-byte command)	1	0	0	1	1	0	0	0	0	0		60h	
		0	0	-	-	-	-	-	-	-	-	#	<b>0: disable</b> 1: enable	
		0	0	-	-	-	-	-	-	-	-	-	(Don't Care)	
31.	CGROM Font Select (Triple-byte command)	1	0	0	1	1	1	0	0	0	0		70h	
		0	0	-	-	-	-	-	-	#	#	00b: Don't care 01b: Don't care 10b: CGROM Font-01 11b: CGROM Font-02		
		0	0	-	-	-	-	-	-	-	-	-	(Don't Care)	

**13. QUALITY DESCRIPTION**

**DEFECT SPECIFICATION:**

Specific type-related items are covered in this sheet.

- a: Table for Cosmetic defects  
(Note: nc = not counted).  
Sizes and number of defects  
(Max. Qty)

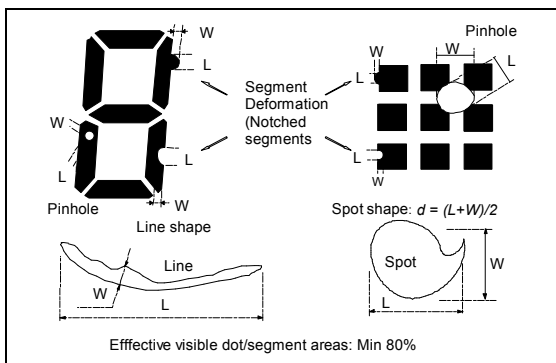

**Examples/ Shapes**

- b: Glass defects
- b1: Glass defects at the contact ledge

b2: Glass chipping in other areas shall not be in conflict with the product' function.

Defect Type	Max. defect size [ $\mu\text{m}$ ] d or L W	Max. Quantity
Black or White Spots	$d \leq 150$	nc
	$150 < d \leq 300$	5
Black or White Lines	-- $W \leq 10$	nc
	$L \leq 5000$ $W \leq 30$	3
Pinhole	$L \leq 2000$ $W \leq 50$	2
	$d \leq 150$ $150 < d \leq 300$	nc 1/segment
(Total defects)		(5)
Segment Deformation	$W \leq 100$	nc
Bubble (e.g. under pola)	$d \leq 150$	nc
	$200 < d \leq 400$	3
	$400 < d \leq 600$	1

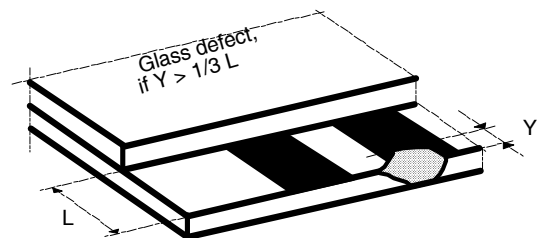



**14. MODULE ACCEPT QUALITY LEVEL (AQL)**

14.1 AQL standard value: Critical defect =0.1, Major defect=0.65; Minor defect =2.5.

14.2 Inspection Plan: MIL-STD-105E, Normal Inspection Level II, Single Sampling Plan.

**15. RELIABILITY TEST**

Operating life time: Longer than 50000 hours (at room temperature without direct irradiation of sunlight)

Reliability characteristics shall meet following requirements.

<b>Test Item</b>	<b>Test Condition</b>
High Temperature Storage	+75°C x 96 hrs( without polarizer)
Low Temperature Storage	-25°C x 96 hrs
High Temperature Operation	+70°C x 96 hrs
Low Temperature Operation	-20°C x 96 hrs
High Temperature, High Humidity	+70°C x 95%RH x 96 hrs( without polarizer)
Thermal Shock	-20°C x 30min → 25°C x 10s → +70°C x 30min x 5 Cycles
Vibration Test	Frequency x Swing x Time 40Hz x 4mm x 4hrs
Drop Test	Height x no. of drop 1.0m x 6 drops

**16. LCD MODULES HANDLING PRECAUTIONS**

- Please remove the protection foil of polarizer before using.
- The display panel is made of glass. Do not subject it to a mechanical shock by dropping it from a high place, etc.
- If the display panel is damaged and the liquid crystal substance inside it leaks out, do not get any in your mouth. If the substance come into contact with your skin or clothes promptly wash it off using soap and water.
- Do not apply excessive force to the display surface or the adjoining areas since this may cause the color tone to vary.
- The polarizer covering the display surface of the LCD module is soft and easily scratched. Handle this polarize carefully.
- To prevent destruction of the elements by static electricity, be careful to maintain an optimum work environment.
  - Be sure to ground the body when handling the LCD module.
  - Tools required for assembly, such as soldering irons, must be properly grounded.
  - To reduce the amount of static electricity generated, do not conduct assembly and other work under dry conditions.
  - The LCD module is coated with a film to protect the display surface. Exercise care when peeling off this protective film since static electricity may be generated.
- Storage precautions  
When storing the LCD modules, avoid exposure to direct sunlight or to the light of fluorescent lamps. Keep the modules in bags designed to prevent static electricity charging under low temperature / normal humidity conditions (avoid high temperature / high humidity and low temperatures below 0°C). Whenever possible, the LCD modules should be stored in the same conditions in which they were shipped from our company.

**17. OTHERS**

- Liquid crystals solidify at low temperature (below the storage temperature range) leading to defective orientation of liquid crystal or the generation of air bubbles (black or white). Air bubbles may also be generated if the module is subjected to a strong shock at a low temperature.
- If the LCD modules have been operating for a long time showing the same display patterns may remain on the screen as ghost images and a slight contrast irregularity may also appear. Abnormal operating status can be resumed to be normal condition by suspending use for some time. It should be noted that this phenomena does not adversely affect performance reliability.
- To minimize the performance degradation of the LCD modules resulting from caused by static electricity, etc. exercise care to avoid holding the following sections when handling the modules:
  - Exposed area of the printed circuit board
  - Terminal electrode sections