

Display Elektronik GmbH

DATA SHEET

TFT MODULE

DEM 7201280A

VMH-PW-N

5“ TFT

Product Specification

Ver.: 0

25.08.2017

Revision History

VERSION	DATE	REVISED PAGE NO.	Note
0	25.08.2017		First Issue

Contents

1. Summary
2. General Specification
3. Interface
4. Counter Drawing
5. Absolute Maximum Ratings
6. Electrical Characteristics
7. DC Characteristics
8. AC Characteristics
9. Power ON/OFF Sequence
10. Optical Characteristics
11. Reliability

1. Summary

This 5.0" TFT is a color active matrix thin film transistor (IPS) liquid crystal display (LCD) that uses amorphous silicon TFT as a switching device. This TFT LCD has a 4.99 (16:9) inch diagonally measured active display area with HD (720 horizontal by 1280 vertical pixel) resolution. This module is composed of a TFT_LCD module and follows RoHS.

2. General Specifications

- Size: 5.0 Inch
- Dot Matrix: 720 x RGB x 1280 Dots
- Module Dimension: 66.10 x 120.40 x 1.85 mm
- Active Area: 62.10 x 110.40 mm
- Dot Pitch: 0.08625 x 0.08625 mm
- LCD Type: IPS TFT, Normally Black, Transmissive
- Viewing Angle: 80/80/80/80
- Aspect Ratio: 16:9
- Backlight Type: LED ,Normally White
- Brightness: typ. 300cd/m²
- With / Without TP: Without TP
- Surface: Glare

*Color tone slight changed by temperature and driving voltage.

3. Interface

3.1. LCM PIN Definition

Pin	Symbol	Function	Remark
1	NC/TP_GND	No connection	
2	NC/TP_SDA	No connection	
3	NC/TP_SCL	No connection	
4	NC/TP_INT	No connection	
5	NC/TP_RST	No connection	
6	NC/YU	No connection	
7	NC/XL	No connection	
8	NC/YD	No connection	
9	NC/XR	No connection	
10-11	VCI	Power supply for analog circuits. Connect to an external power supply of 2.5V to 3.6V	
12-13	NC	No connection	
14	RESET	The external reset input Initializes the chip with a low input. Be sure to execute a power-on reset after supplying power. Fix to VDDI level when not in use.	
15	TE	Tearing effect output pin. Leave the pin open when not in use.	
16	NC	No connection	
17-18	GND	Power ground	
19-20	IOVCC	Power supply for analog circuits. Connect to an external power supply of 1.65V to 3.6V	
21	GND	Power ground	
22	D3P	MIPI DSI differential data pair. (Data lane 3)	
23	D3N	Leave it open or fix to LVDSVSS level when not in use.	
24	GND	Power ground	
25	D2P	MIPI DSI differential data pair. (Data lane 2)	
26	D2N	Leave it open or fix to LVDSVSS level when not in use.	
27	GND	Power ground	
28	CLKP	MIPI DSI differential clock pair	
29	CLKN	Leave it open or fix to LVDSVSS level when not in use.	
30	GND	Power ground	
31	D1P	MIPI DSI differential data pair. (Data lane 1)	
32	D1N	Leave it open or fix to LVDSVSS level when not in use.	
33	GND	Power ground	
34	D0P	MIPI DSI differential data pair. (Data lane 0)	
35	D0N	Leave it open or fix to LVDSVSS level when not in use.	
36-37	GND	Power ground	
38	LED+	Power for LED backlight anode	
39	LED1-	Power for LED1 backlight cathode	
40	LED2-	Power for LED2 backlight cathode	

4. Counter Drawing

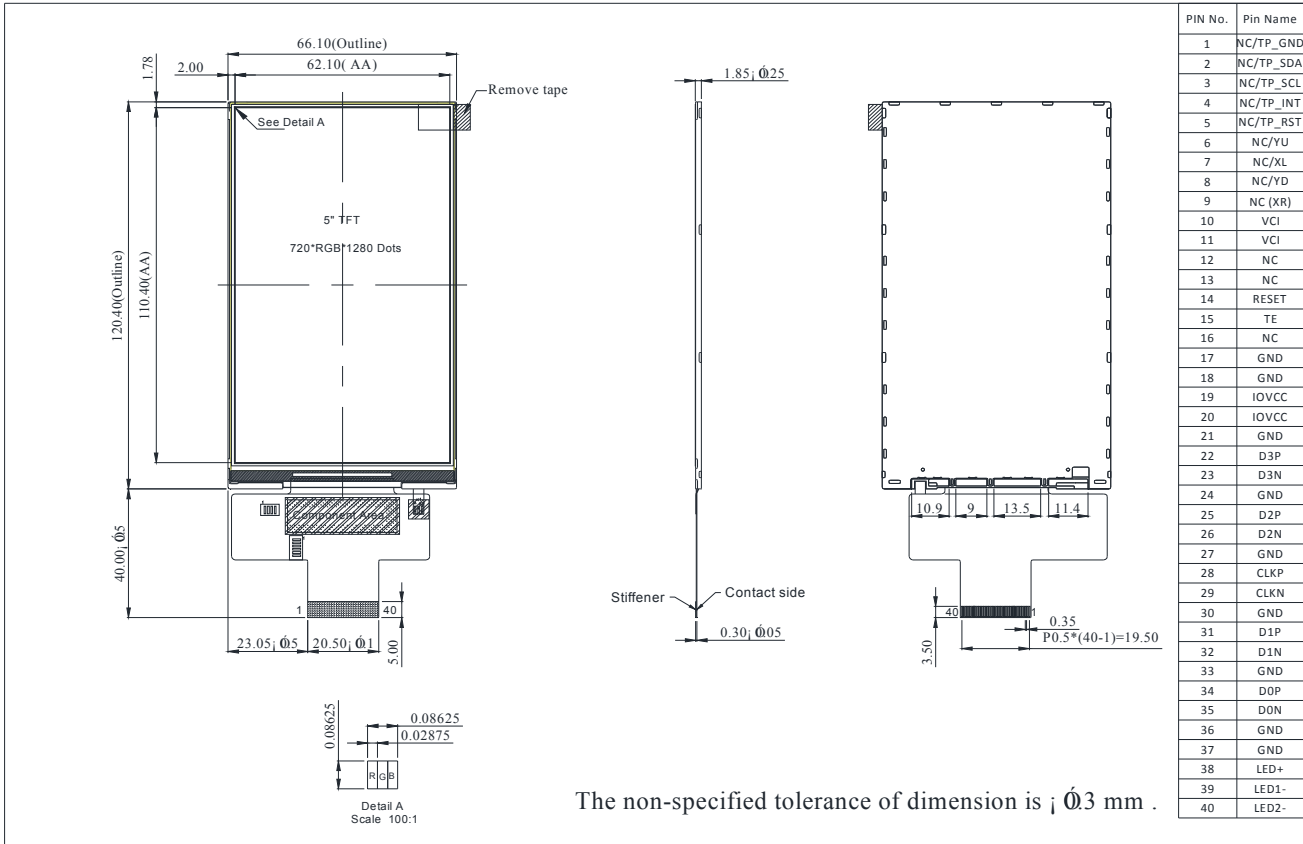

5. Absolute Maximum Ratings

Item	Symbol	Min	Typ	Max	Unit
Operating Temperature	T _{OP}	-20	—	+70	°C
Storage Temperature	T _{ST}	-30	—	+80	°C

Note: Device is subject to be damaged permanently if stresses beyond those absolute maximum ratings listed above

1. Temp. $\leq 60^{\circ}\text{C}$, 90% RH MAX. Temp. $> 60^{\circ}\text{C}$,
Absolute Humidity shall be less than 90% RH at 60°C

6. Electrical Characteristics

6.1. Typical Operation Conditions

Item	Symbol	Values			Unit	Remark
		Min.	Typ.	Max.		
Power Supply for Analog Circuit	VCI	2.5	3.3	3.6	V	
Power Supply for Logic Circuit	IOVCC	1.65	1.8	3.6	V	
Current for Driver	IDD	-	44		mA	VDD=3.3V Note1

6.2. Backlight Driving Conditions

Parameter	Symbol	Min.	Typ.	Max.	Unit	Remark
LED Current	I _{LED}	-	40	-	mA	
LED Voltage	V _{LED+}	19.6	-	23.8	V	Note 1
LED Lifetime		30,000	-	-	Hr	Note 2,3,4

Note 1: There are 1 Groups LED

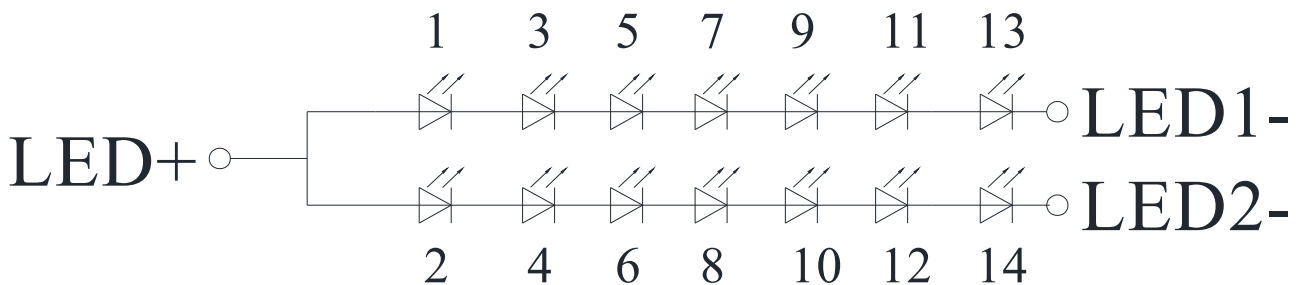

Note 2: Ta = 25°C

Note 3: Brightness to be decreased to 50% of the initial value

Note 4: The single LED lamp case7.3.

7. DC CHARACTERISTICS

7.1. Basic Characteristics for Panel Driving

Parameter	Symbol	Rating			Unit	Condition	Note
		Min	Typ	Max			
Logic Low Level Input Voltage	V_{IL}	-0.3	-	$0.3 \cdot IOVCC$	V		Note1
Logic High Level Input Voltage	V_{IH}	$0.7 \cdot IOVCC$	-	$IOVCC$	V		Note1
Logic Low Level Output Voltage (TE)	V_{OL}	0		$0.2 \cdot IOVCC$	V	$I_{OL} = +1.0mA$	Note1
Logic High Level Output Voltage (TE)	V_{OH}	$0.8 \cdot IOVCC$		$IOVCC$	V	$I_{OH} = -1.0mA$	Note1

NOTE1:

$T_a = -20$ to $+70^\circ C$, $V_{CI} = 2.5V$ to $3.6V$, $IOVCC = 1.65V$ to $3.6V$

7.2. DSI DC Characteristics

LP Mode

Parameter	Symbol	Condition	Specification			Unit
			Min.	Typ.	Max.	
Logic 1 input voltage	V_{IHLPCD}	LP-CD	450	-	1350	mV
Logic 0 input voltage	V_{ILLPCD}	LP-CD	0.0	-	200	mV
Logic 1 input voltage	V_{IHLPRX}	LP-RX (CLK, D0, D1, D2, D3)	880	-	1350	mV
Logic 0 input voltage	V_{ILLPRX}	LP-RX (CLK, D0, D1, D2, D3)	0.0	-	550	mV
Logic 0 input voltage	$V_{ILLPRXULP}$	LP-RX (CLK ULP mode)	0.0	-	300	mV
Logic 1 output voltage	V_{OHLPTX}	LP-TX (D0)	1.1	-	1.3	V
Logic 0 output voltage	V_{OLLPTX}	LP-TX (D0)	-50	-	50	mV
Logic 1 input current	I_{IH}	LP-CD, LP-RX	-	-	10	μA
Logic 0 input current	I_{IL}	LP-CD, LP-RX	-10	-	-	μA

Spike/Glitch Rejection

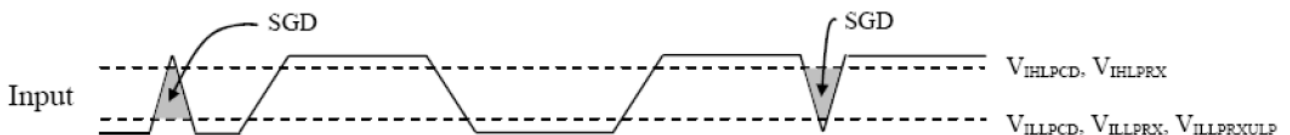

Spike/Glitch Rejection – DSI					
Signal	Symbol	Parameter	Min	Max	Unit
CLKP/N, DnP/N	SGD	Input pulse rejection for DSI	-	300	Vps

High Speed Mode

Parameter	Symbol	Condition	Specification			Unit
Input Common Mode Voltage for Clock	V_{CMCLK}	CLKP/N Note 2, Note 3	70	-	330	mV
Input Common Mode Voltage for Data	V_{CMDATA}	DnP/N Note 2, Note 3, Note 5	70	-	330	mV
Common Mode Ripple for Clock Equal or Less than 450MHz	$V_{CMRCLKL450}$	CLKP/N Note 4	-50	-	50	mV
Common Mode Ripple for Data Equal or Less than 450MHz	$V_{CMRDATAL450}$	DnP/N Note 4, Note 5	-50	-	50	mV
Common Mode Ripple for Clock More than 450MHz (peak sine wave)	$V_{CMRCLKM450}$	CLKP/N	-	-	100	mV
Common Mode Ripple for Data More than 450MHz (peak sine wave)	$V_{CMRDATAM450}$	DnP/N Note 5	-	-	100	mV
Differential Input Low Level Threshold Voltage for Clock	V_{THCLK-}	CLKP/N	-70	-	-	mV
Differential Input Low Level Threshold Voltage for Data	$V_{THLDATA-}$	DnP/N Note 5	-70	-	-	mV
Differential Input High Level Threshold Voltage for Clock	V_{THCLK+}	CLKP/N	-	-	70	mV
Differential Input High Level Threshold Voltage for Data	$V_{THDATA+}$	DnP/N Note 5	-	-	70	mV
Single-ended Input Low Voltage	V_{ILHS}	CLKP/N, DnP/N Note 3, Note 5	-40	-	-	mV
Single-ended Input High Voltage	V_{IHHS}	CLKP/N, DnP/N Note 3, Note 5	-	-	460	mV
Differential Termination Resistor	R_{TERM}	CLKP/N, DnP/N Note 5	80	100	125	Ω
Single-ended Threshold Voltage for Termination Enable	$V_{TERM-EN}$	CLKP/N, DnP/N Note 5	-	-	450	mV
Termination Capacitor	C_{TERM}	CLKP/N, DnP/N Note 5, Note 6	-	-	60	pF

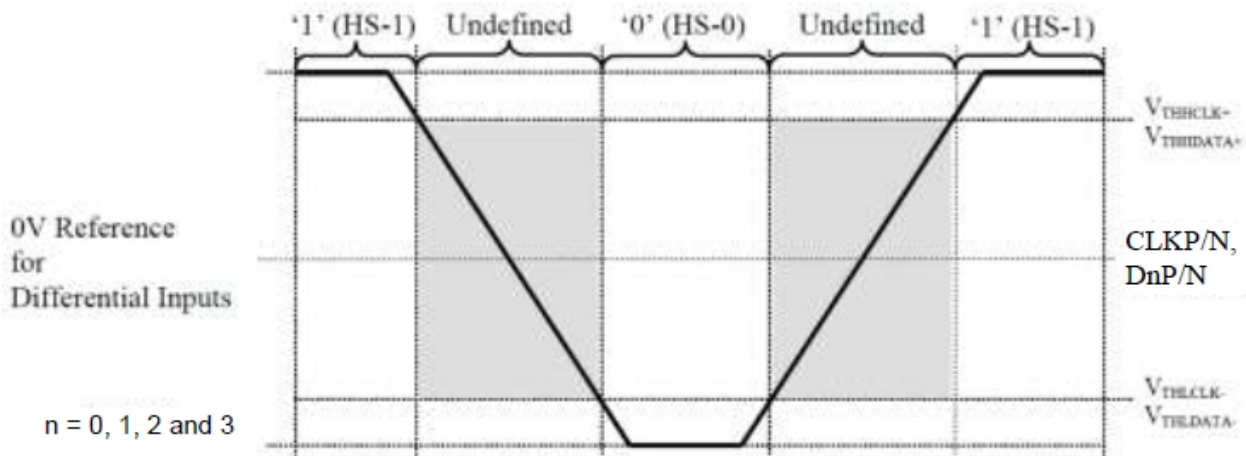

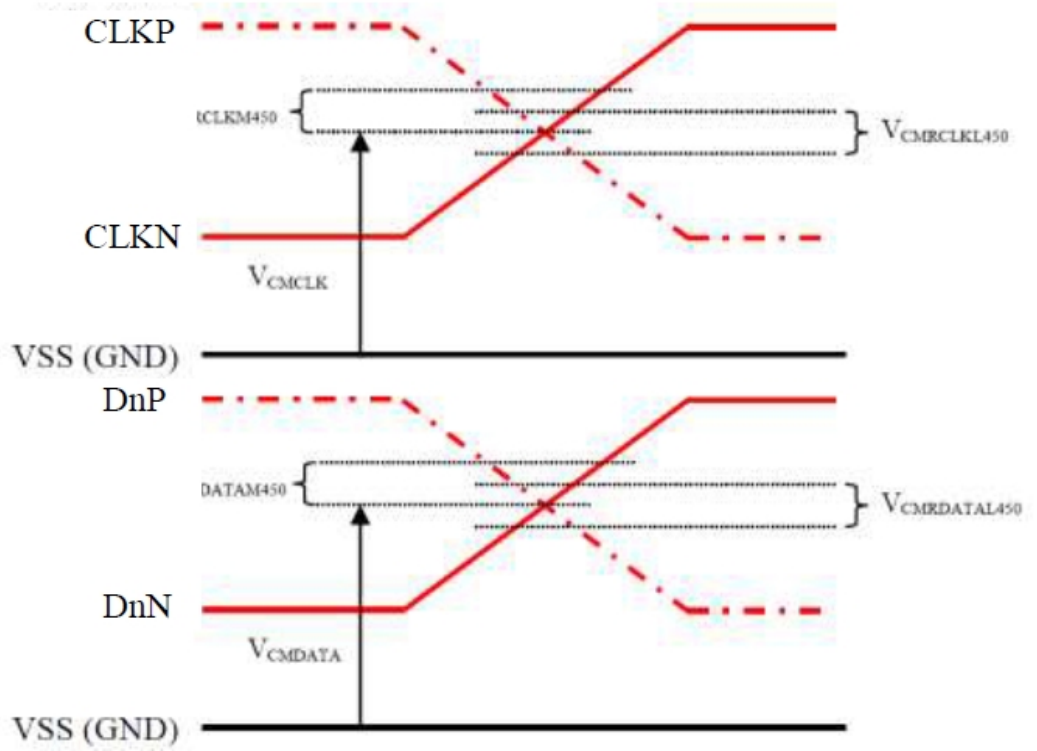

Note: $n = 0, 1, 2$ and 3

8. AC Characteristics

8.1. DSI Interface Timing Characteristics

8.1.1 High Speed Mode – Clock Channel Timing

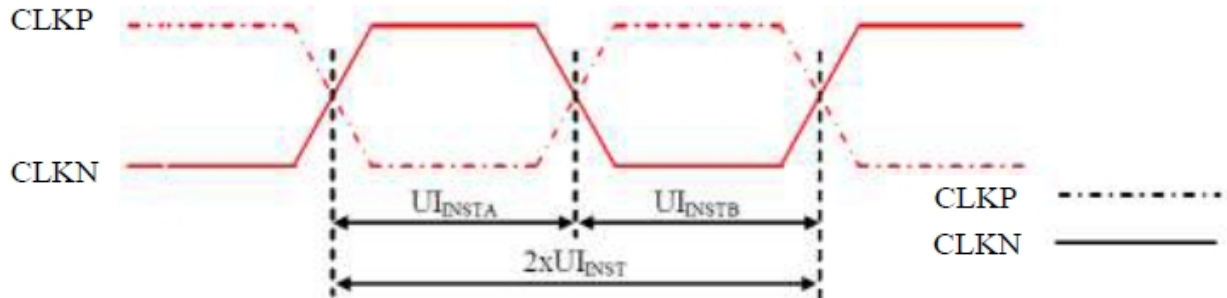

Signal	Symbol	Parameter	Min	Max	Unit
CLKP/N	$2xUI_{INST}$	Double UI instantaneous	Note 2	25	ns
CLKP/N	UI_{INSTA}, UI_{INSTB} (Note 1)	UI instantaneous Half	Note 2	12.5	ns

Notes:

1. $UI = UI_{INSTA} = UI_{INSTB}$

Data type	Two Lanes speed	Three Lanes speed	Four Lanes speed
Data Type = 00 1110 (0Eh), RGB 565, 16 UI per Pixel	566 Mbps	466 Mbps	366 Mbps
Data Type = 01 1110 (1Eh), RGB 666, 18 UI per Pixel	637 Mbps	525 Mbps	412 Mbps
Data Type = 10 1110 (2Eh), RGB 666 Loosely, 24 UI per Pixel	850 Mbps	700 Mbps	550 Mbps
Data Type = 11 1110 (3Eh), RGB 888, 24 UI per Pixel	850 Mbps	700 Mbps	550 Mbps

8.1.2 High Speed Mode – Data Clock Channel Timing

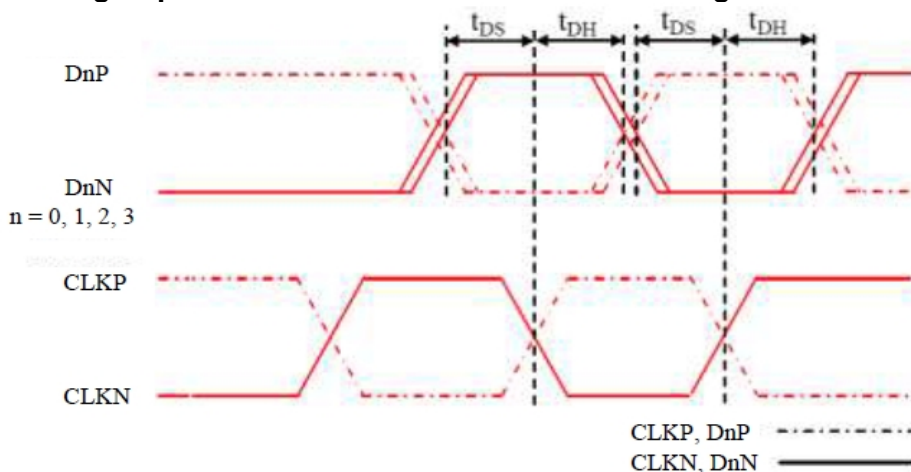

Signal	Symbol	Parameter	Min	Max
DnP/N , n=0 and 1	t_{DS}	Data to Clock Setup time	$0.15xUI$	-
	t_{DH}	Clock to Data Hold Time	$0.15xUI$	-

8.1.3 High Speed Mode – Rising and Falling Timings

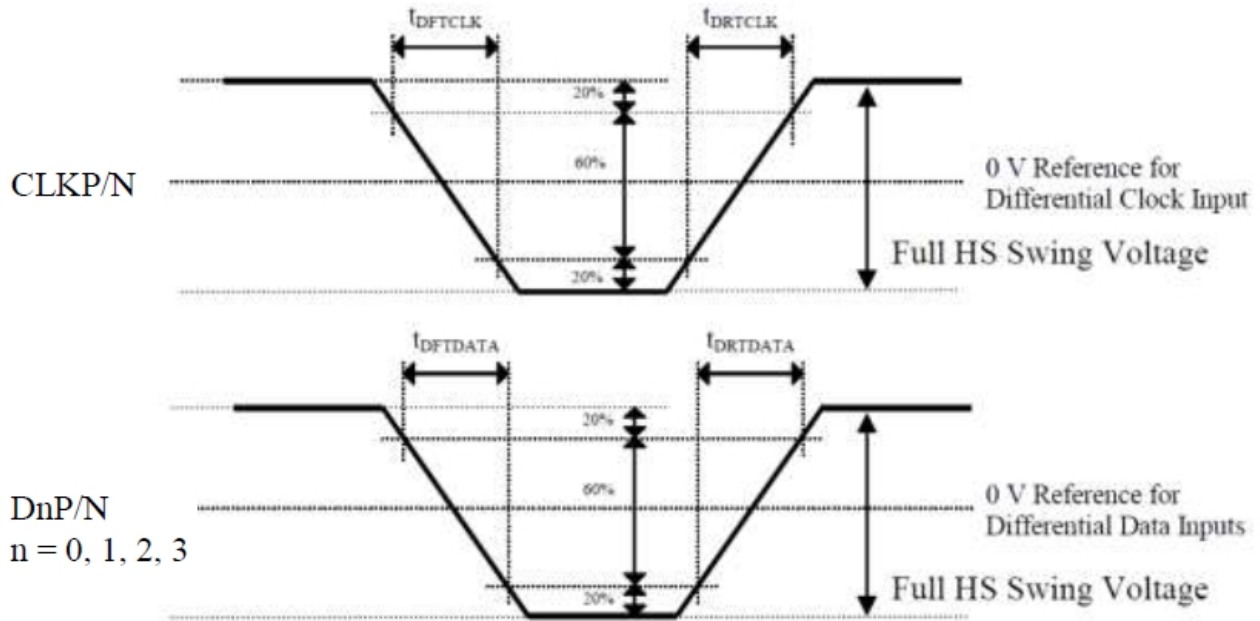
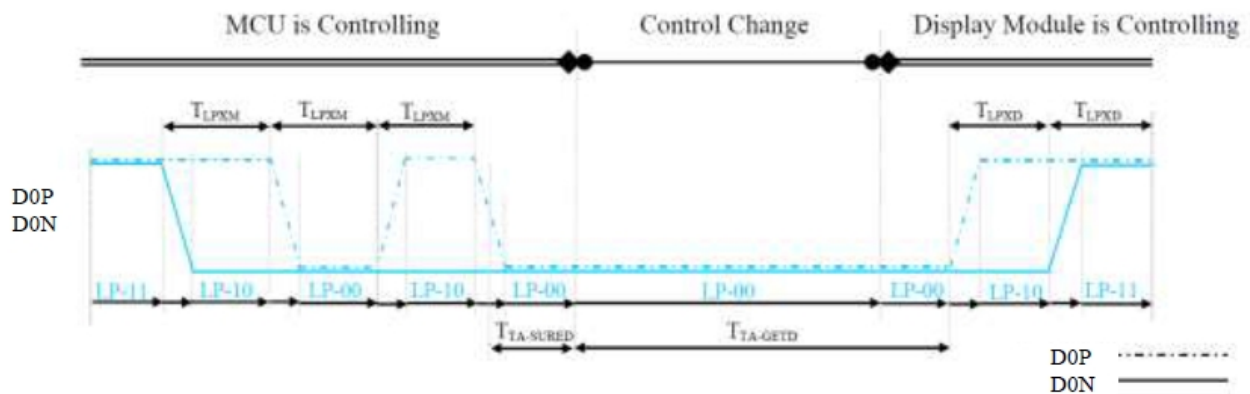

Table 41: Rise and Fall Timings on Clock and Data Channels

Parameter	Symbol	Condition	Specification		
			Min	Typ	Max
Differential Rise Time for Clock	t_{DRTCLK}	CLKP/N	150 ps	-	0.3UI (Note)
Differential Rise Time for Data	$t_{DRTDATA}$	DnP/N n=0 and 1	150 ps	-	0.3UI (Note)
Differential Fall Time for Clock	t_{DFTCLK}	CLKP/N	150 ps	-	0.3UI (Note)
Differential Fall Time for Data	$t_{DFTDATA}$	DnP/N n=0 and 1	150 ps	-	0.3UI (Note)

Note: The display module has to meet timing requirements, which are defined for the transmitter (MCU) on MIPI D-Phy standard.

8.1.4 Low Power Mode – Bus Turn Around



BTA from the MCU to Display Module

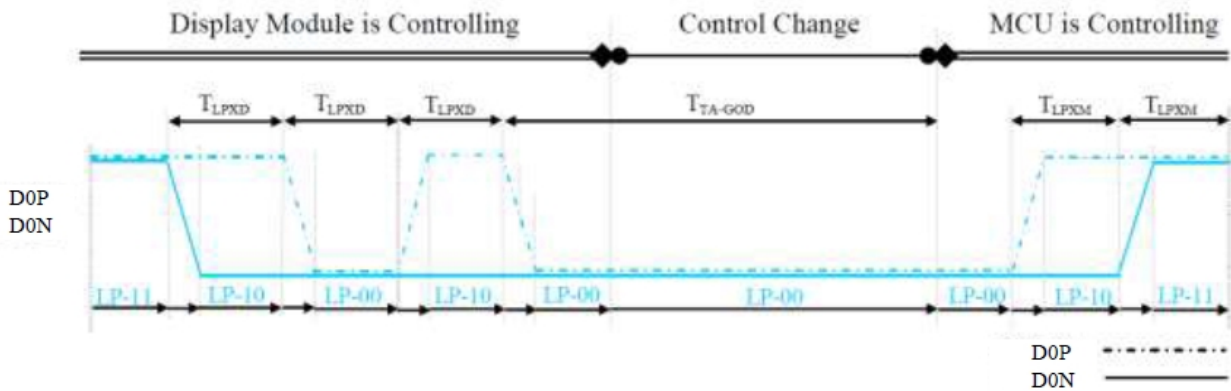

BTA from Display Module to the MCU

Signal	Symbol	Description	Min	Max	Unit
D0P/N	T_{LPXM}	Length of LP-00, LP-01, LP-10 or LP-11 periods MCU → Display Module (ILI9881C)	50	75	ns
D0P/N	T_{LPXD}	Length of LP-00, LP-01, LP-10 or LP-11 periods Display Module (ILI9881C) → MCU	50	75	ns
D0P/N	$T_{TA-SURED}$	Time-out before the Display Module (ILI9881C) starts driving	T_{LPXD}	$2 \times T_{LPXD}$	ns

Signal	Symbol	Description	Time	Unit
D0P/N	$T_{TA-GETD}$	Time to drive LP-00 by Display Module (ILI9881C)	$5 \times T_{LPXD}$	ns
D0P/N	T_{TA-GOD}	Time to drive LP-00 after turnaround request - MCU	$4 \times T_{LPXD}$	ns

8.1.5 Data Lanes from Low Power Mode to High Speed Mode

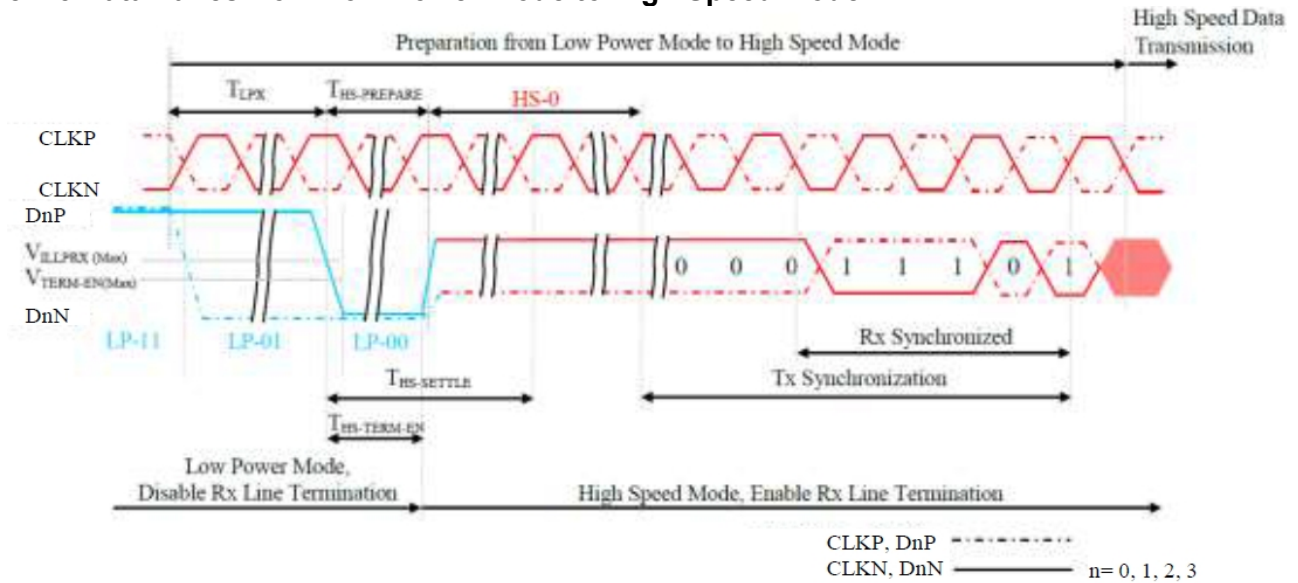

Signal	Symbol	Description	Min	Max	Unit
DnP/N, n = 0 and 1	T_{LPX}	Length of any Low Power State Period	50	-	ns
DnP/N, n = 0 and 1	$T_{HS-PREPARE}$	Time to drive LP-00 to prepare for HS Transmission	$40+4xUI$	$85+6xUI$	ns
DnP/N, n = 0 and 1	$T_{HS-TERM-EN}$	Time to enable Data Lane Receiver line termination measured from when Dn crosses V_{ILMAX}	-	$35+4xUI$	ns

8.1.6 Data Lanes from High Speed Mode to Low Power Mode

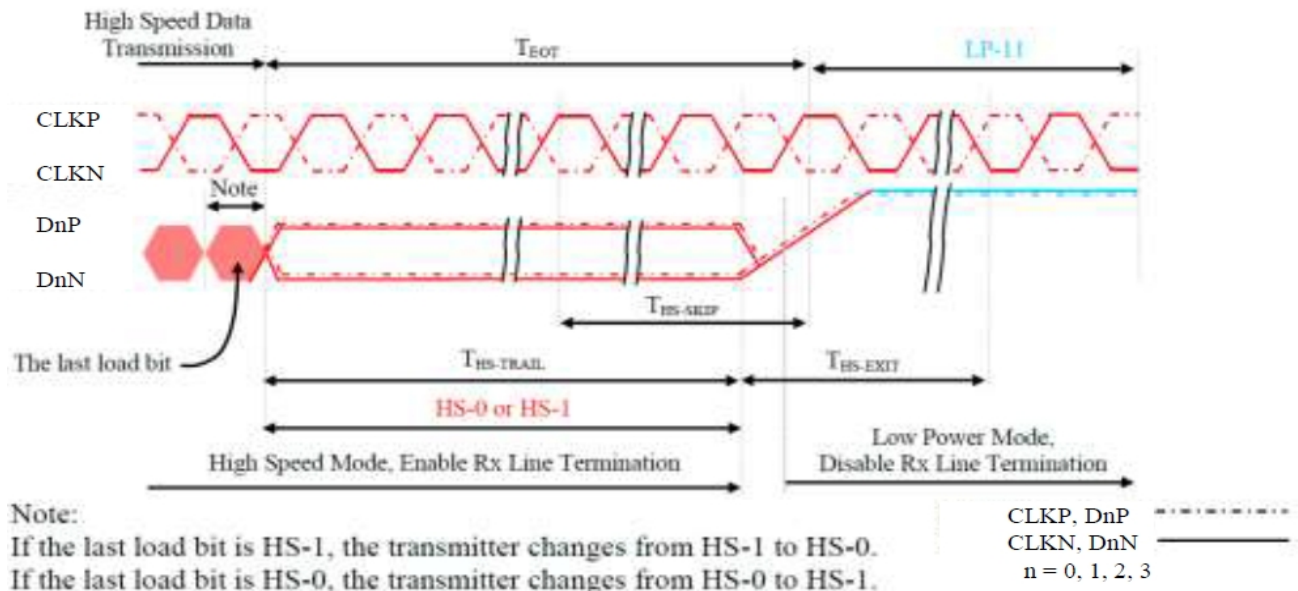

Signal	Symbol	Description	Min	Max	Unit
DnP/N, n = 0 and 1	$T_{HS-SKIP}$	Time-Out at Display Module (ILI9881C) to ignore transition period of EoT	40	$55+4xUI$	ns
DnP/N, n = 0 and 1	$T_{HS-EXIT}$	Time to driver LP-11 after HS burst	100	-	ns

8.1.7 Clock Lanes High Speed Mode to/from Low Power Mode Timing

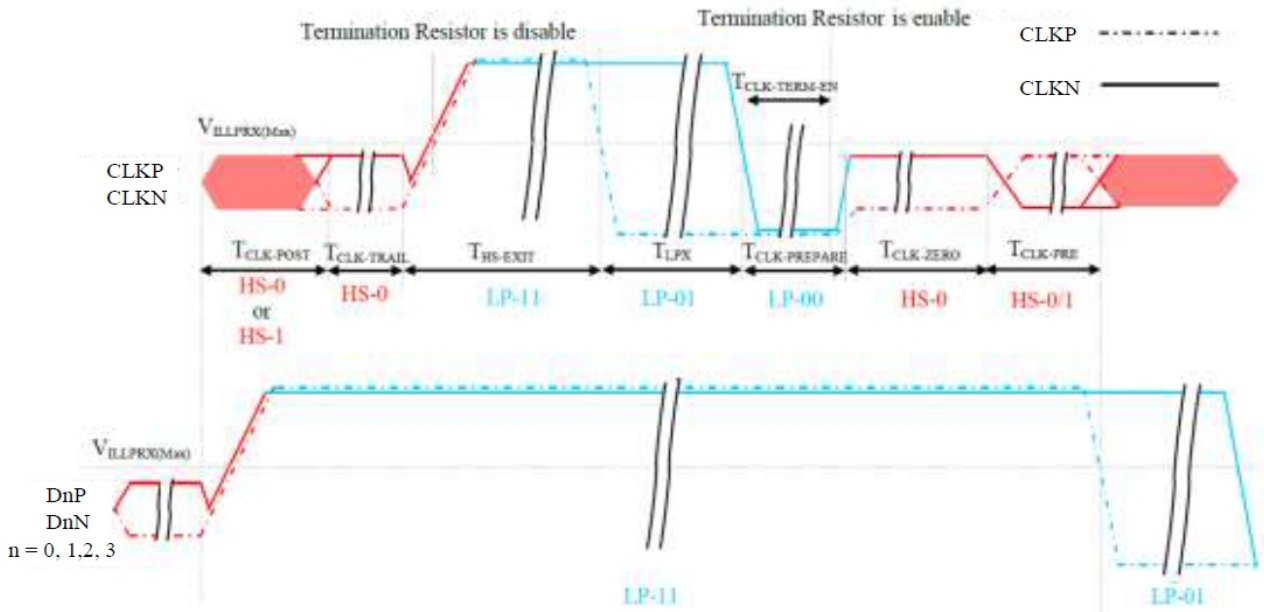

Signal	Symbol	Description	Min	Max	Unit
CLKP/N	$T_{CLK-POST}$	Time that the MCU shall continue sending HS clock after the last associated Data Lanes has transitioned to LP mode	$60+52xUI$	-	ns
CLKP/N	$T_{CLK-TRAIL}$	Time to drive HS differential state after last payload clock bit of a HS transmission burst	60	-	ns
CLKP/N	$T_{HS-EXIT}$	Time to drive LP-11 after HS burst	100	-	ns
CLKP/N	$T_{CLK-PREPARE}$	Time to drive LP-00 to prepare for HS transmission	38	95	ns
CLKP/N	$T_{CLK-TERM-EN}$	Time-out at Clock Lane to enable HS termination	-	38	ns
CLKP/N	$T_{CLK-PREPARE} + T_{CLK-ZERO}$	Minimum lead HS-0 drive period before starting Clock	300	-	ns
CLKP/N	$T_{CLK-PRE}$	Time that the HS clock shall be driven prior to any associated Data Lane beginning the transition from LP to HS mode	$8xUI$	-	ns

8.2. Reset Timing

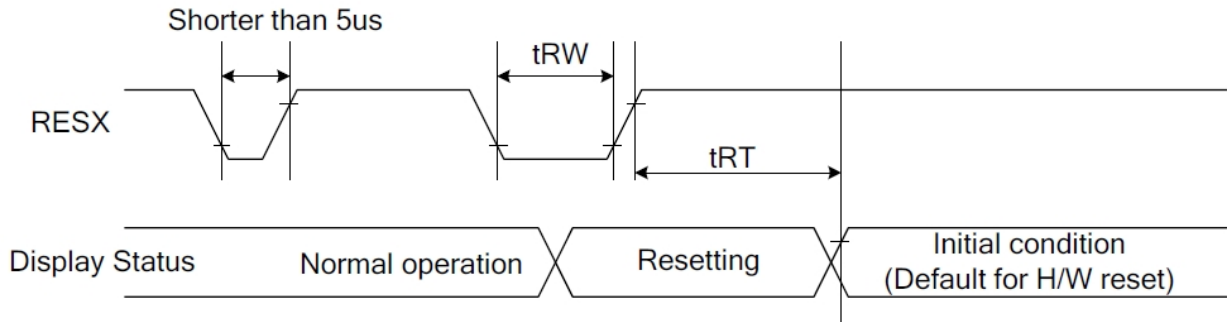

Signal	Symbol	Parameter	Min	Max	Unit
RESX	tRW	Reset pulse duration	10		us
	tRT	Reset cancel		5 (Note 1, 5)	ms
				120 (Note 1, 6, 7)	

Notes:

1. The reset cancel includes also required time for loading ID bytes, VCOM setting and other settings from NVM (or similar device) to registers. This loading is done every time when there is HW reset cancel time (tRT) within 5 ms after a rising edge of RESX.
2. Spike due to an electrostatic discharge on RESX line does not cause irregular system reset according to the table below:

RESX Pulse	Action
Shorter than 5us	Reset Rejected
Longer than 10us	Reset
Between 5us and 10us	Reset starts

3. During the Resetting period, the display will be blanked (The display is entering blanking sequence, which maximum time is 120 ms, when Reset Starts in Sleep Out –mode. The display remains the blank state in Sleep In –mode.) and then return to Default condition for Hardware Reset.
4. Spike Rejection also applies during a valid reset pulse as shown below:

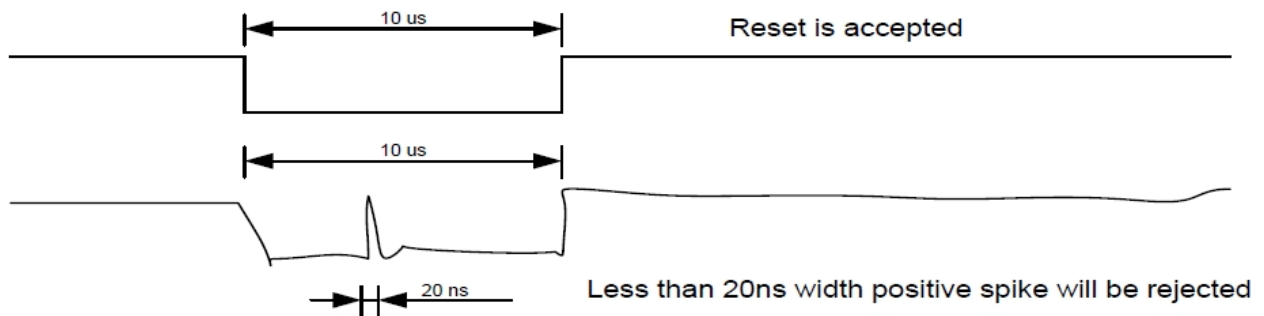

5. When Reset applied during Sleep In Mode.
6. When Reset applied during Sleep Out Mode.
7. It is necessary to wait 5msec after releasing RESX before sending commands. Also Sleep Out command cannot be sent for 120msec.

9. Power ON/OFF Sequence

Case A:

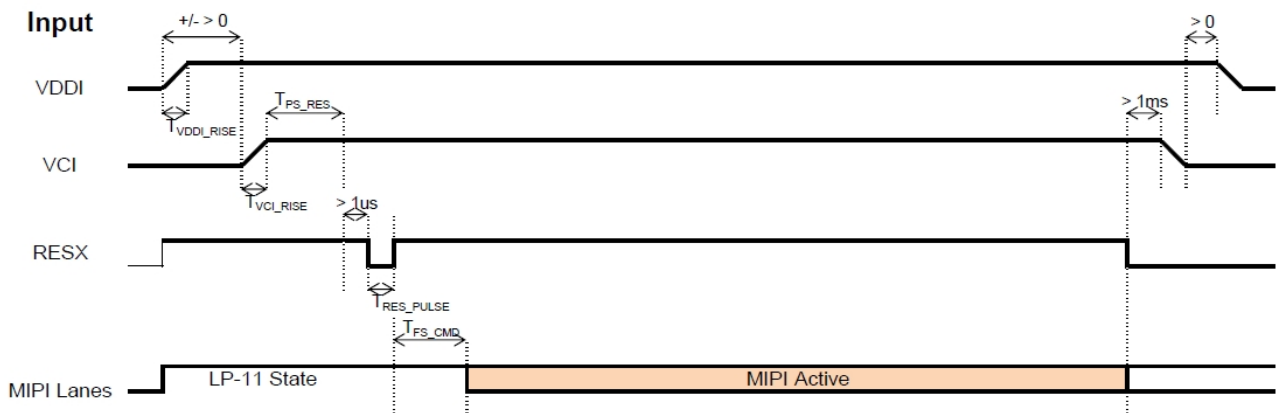

Case B:

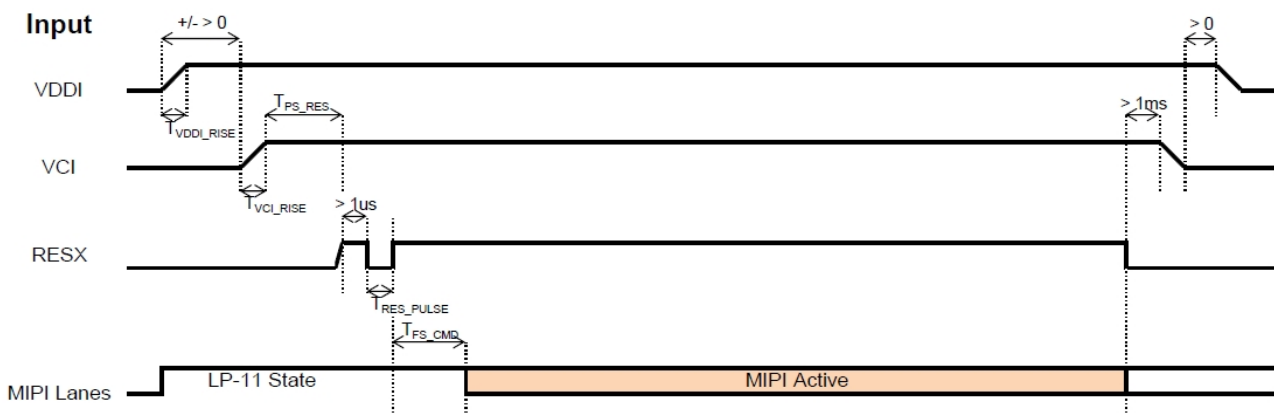

Symbol	Characteristics	Min.	Typ.	Max.	Units
T_{VDDI_RISE}	VDDI Rise time	10	-	-	us
T_{VCI_RISE}	Case A: VCI Rise time	130	-	-	us
	Case B: VCI Rise time	40	-	-	us
T_{PS_RES}	VDDI/VCI on to Reset high	5	-	-	ms
T_{RES_PULSE}	Reset low pulse time	10	-	-	us
T_{FS_CMD}	Reset to first command	10	-	-	ms

10. Optical Characteristics

Item	Symbol	Condition.	Min	Typ.	Max.	Unit	Remark
Response Time	Tr	$\theta=0^\circ$ 、 $\phi=0^\circ$	-	10	15	.ms	Note 3,5
	Tf		-	20	25	.ms	
Contrast Ratio	CR	At optimized viewing angle	640	800	-	-	Note 4,5
Color Chromaticity	White	$\theta=0^\circ$ 、 $\phi=0$	0.283	0.303	0.323		Note 2,6,7
			0.303	0.323	0.343		
Viewing Angle	Hor.	Θ_R	-	80	-	Deg.	Note 1
		Θ_L	-	80	-		
	Ver.	Φ_T	-	80	-		
		Φ_B	-	80	-		
Brightness	-	-	250	300	-	cd/ m ²	Center of display

Ta=25°C ± 2°C

Note 1: Definition of viewing angle range

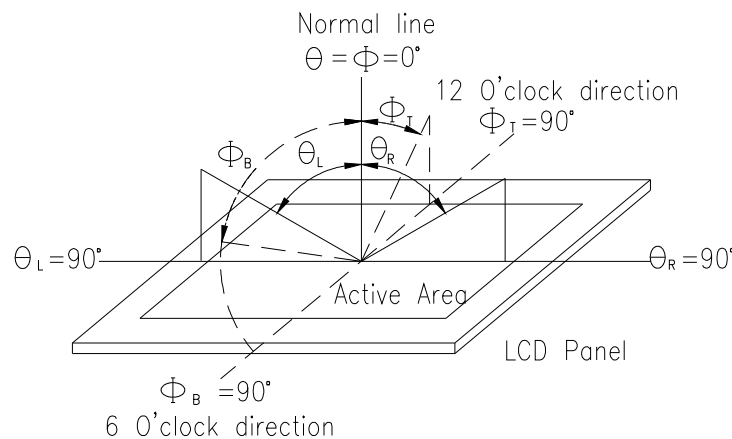

Fig. 11.1. Definition of viewing angle

Note 2: Test equipment setup:

After stabilizing and leaving the panel alone at a driven temperature for 10 minutes, the measurement should be executed. Measurement should be executed in a stable, windless, and dark room. Optical specifications are measured by Topcon BM-7 or BM-5 luminance meter 1.0° field of view at a distance of 50cm and normal direction.

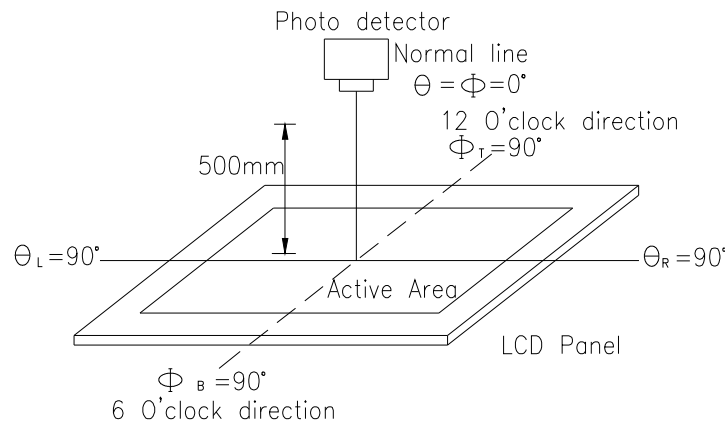
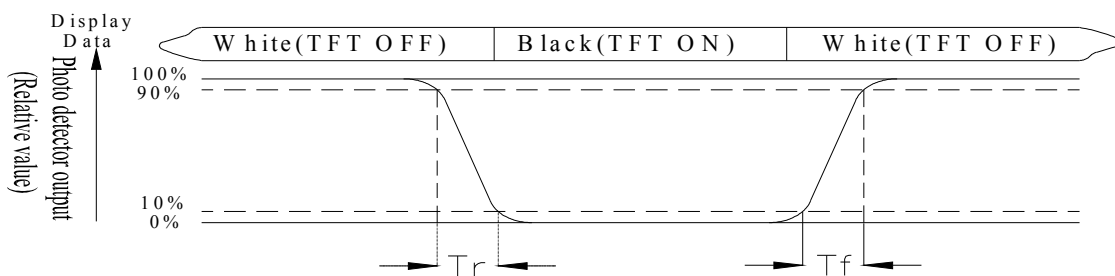

Fig. 11.2. Optical measurement system setup

Note 3: Definition of Response time:

The response time is defined as the LCD optical switching time interval between “White” state and “Black” state. Rise time, T_r , is the time between photo detector output intensity changed from 90% to 10%. And fall time, T_f , is the time between photo detector output intensity changed from 10% to 90%



Note 4: Definition of contrast ratio:

The contrast ratio is defined as the following expression.

$$\text{Contrast ratio (CR)} = \frac{\text{Luminance measured when LCD on the "White" state}}{\text{Luminance measured when LCD on the "Black" state}}$$

Note 5: White $V_i = V_{i50} \pm 1.5V$

Black $V_i = V_{i50} \pm 2.0V$

“±” means that the analog input signal swings in phase with VCOM signal.

“±” means that the analog input signal swings out of phase with VCOM signal.

The 100% transmission is defined as the transmission of LCD panel when all the input terminals of module are electrically opened.

Note 6: Definition of color chromaticity (CIE 1931)

Color coordinates measured at the center point of LCD

Note 7: Measured at the center area of the panel when all the input terminals of LCD panel are electrically opened.

11. Reliability

Content of Reliability Test (Wide temperature, -20°C~+70°C)

Environmental Test			
Test Item	Content of Test	Test Condition	Note
High Temperature storage	Endurance test applying the high storage temperature for a long time.	+80°C 200hrs	2
Low Temperature storage	Endurance test applying the low storage temperature for a long time.	-30°C 200hrs	1,2
High Temperature Operation	Endurance test applying the electric stress (Voltage & Current) and the thermal stress to the element for a long time.	+70°C 200hrs	—
Low Temperature Operation	Endurance test applying the electric stress under low temperature for a long time.	-20°C 200hrs	1
High Temperature/ Humidity Operation	The module should be allowed to stand at 60□,90%RH max	+60°C,90%RH 96hrs	1,2
Thermal Shock Resistance	The sample should be allowed stand the following 10 cycles of operation <div style="text-align: center;"> <p style="margin: 0;">-20°C +25°C +70°C</p> <p style="margin: 0;">30min 5min 30min</p> <p style="margin: 0;">1 cycle</p> </div>	-20°C / +70°C 10 cycles	—
Vibration Test	Endurance test applying the vibration during transportation and using.	Total fixed amplitude : 3 1.5mm Vibration Frequency : 10~55Hz One cycle 60 seconds to 3 directions of X,Y,Z for Each 15 minutes	3
Static Electricity Test	Endurance test applying the electric stress to the terminal.	VS=±600V(Contact), ±800V(Air), RS=330Ω CS=150pF 10 times	—

Note1: No dew condensation to be observed.

Note2: The function test shall be conducted after 4 hours storage at the normal Temperature and humidity after remove from the test chamber.

Note3: The packing have to including into the vibration testing.