

# DATA SHEET

## TFT- MODULE

### **DEM 800480B TMH-PW-N (A-TOUCH)**

**7.0" TFT with Touch-Panel**

12.04.2019



## Contents

1.	General Description and Features	4
1.1	Features	4
1.2	LCD Module	4
2.	Mechanical Information	4
3.	Electrical Specifications	5
3.1	Absolute Max. Ratings	5
3.2	AC Timing Characteristic of The LCD	6
3.3	LVDS Switching Characteristics	8
3.4	Back-Light Unit	10
4.	Optical Characteristics	10
4.1	Optical characteristic of the LCD	10
5.	I/O Terminal	13
5.1	Pin Assignment	13
5.2	Back Light Unit	13
5.3	Touch Panel Unit (Connector Part No: CVILUX CF25041D0R0-10)	14
5.4	Block Diagram	14
7.	Touch Screen Panel Specifications	16
7.1	Touch Panel	16
7.2	Housing Design Guide	17
8.	Reliability Condition	18
9.	Dimensional Outlines	19
10.	Incoming Inspection Standards	20

## 1. General Description and Features

DEM 800480B TMH-PW-N(A-TOUCH) is a transmissive type color active matrix TFT (Thin Film Transistor) liquid crystal display (LCD) that uses amorphous silicon TFT as a switching device. This model is composed of a TFT-LCD module, a receiver circuit, Touch panel and a back-light unit. Graphics and texts can be displayed on a WVGA 800 (W) x RGB x 480 (H) dots (16:9 aspect ratio) with 262,144 colors. The following table described the features of DEM 800480B TMH-PW-N(A-TOUCH).

### 1.1 Features

- Transmissive and back-light with 30 LEDs are available.
- TN (Twisted Nematic) mode.
- LVDS Receiver 18 bit Interface.
- Integrated 4-Wire-Resistive Touch-Panel
- ROHS Compliance

### 1.2 LCD Module

Item	Specification	Unit
Screen Size	7.0 inches	Diagonal
Display Resolution	800 (H) x 480 (V)	Pixel
Active Area	152.4 (H) x 91.44 (V)	mm
Outline Dimension	166.6 (H) x 109.4 (V) x 11.25 (T)	mm
Display Mode	Normally white mode/ Transmissive	--
Pixel Arrangement	R,G,B Vertical Stripe	--
Pixel Size	0.1905 x 0.1905	mm
Surface Treatment	Anti-Glare and Hard Coating(3H)	
Display Color	262K	--
Viewing Direction	6 o'clock (Gray Inversion)	--
Input Interface	LVDS Receiver 18 bit Interface	--

## 2. Mechanical Information

Item	Min.	Typ.	Max.	Unit	Note
Module Size	Horizontal (H)	--	166.6	--	mm
	Vertical (V)	--	109.4	--	mm
	Thickness (T)	--	11.25	--	mm
Weight	--	220	--	g	--

Note (1) Not Include Component. Refer to the Outline Dimension Drawing as attached.

## 3. Electrical Specifications

## 3.1 Absolute Max. Ratings

## 3.1.1 Absolute Ratings of Environment

If the operating condition exceeds the following absolute maximum ratings, the TFT LCD module may be damaged permanently.

( $T_a=25\pm 2^\circ\text{C}$ ,  $V_{SS}=\text{GND}=0$ )

Item	Symbol	Min.	Max.	Unit	Note
Storage temperature	$T_{STG}$	-30	80	$^\circ\text{C}$	(1)
Operating temperature	$T_{OPR}$	-20	70	$^\circ\text{C}$	(1,2,3)

Note (1) 95 % RH Max. ( $40^\circ\text{C} \geq T_a$ ). Maximum wet-bulb temperature at  $39^\circ\text{C}$  or less. ( $T_a > 40^\circ\text{C}$ ) No condensation.

Note (2) In case of below  $0^\circ$ , the response time of liquid crystal (LC) becomes slower and the color of panel becomes darker than normal one. Level of retardation depends on temperature, because of LC's character

Note (3) Only operation is guaranteed at operating temperature. Contrast, response time, another display quality are evaluated at  $+25^\circ\text{C}$ .

## 3.1.2 Electrical Absolute Maximum Ratings

## 3.1.2.1 TFT-LCD Module

( $V_{SS}=\text{GND}=0$ )

Parameter	Symbol	Min.	Max.	Unit	Remark
Power supply voltage	$V_{CC}$	-0.3	4.0	V	
input voltage	$V_I$	-0.3	$V_{CC}+0.3$	V	--

## 3.1.2.2 Backlight Unit

( $V_{SS}=\text{GND}=0$ )

Parameter	Symbol	Min.	Max.	Unit	Remark
Current of Backlight Unit	$I_B$	--	250	mA	
Voltage of Backlight Unit	$V_B$	--	15	V	

**3.1.3 DC Electrical Characteristics of the TFT LCD**

(Ta=25±2°C, Vss=GND=0)

Item	Symbol	Min.	Typ.	Max.	Unit	Remark
Power supply	VCC	3.0	3.3	3.6	V	
Input Voltage for logic	Differential Input High Threshold	VTH		+100	mV	
	Differential Input Low Threshold	VTL	-100		mV	
Power Supply current	ICC	-	215	250	mA	Note 1

Note1: fv =60Hz , Ta=25°C , Display pattern : Black pattern

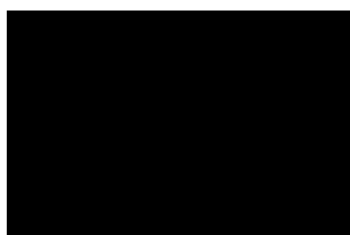

**3.2 AC Timing Characteristic of The LCD**

**3.2.1 Timing Condition (DE only mode)**

Signal	Parameter	Symbol	Min.	Typ.	Max.	Unit.	Remark
DCLK	CLK frequency	F <sub>CPH</sub>	29.4	33.26	42.48	MHz	
	CLK period	T <sub>CPH</sub>	-	30.06	-	ns	
	CLK pulse duty	T <sub>CWH</sub>	40	50	60	%	
DE	DE period	T <sub>DEH</sub> +T <sub>DEL</sub>	1000	1056	1200	T <sub>CPH</sub>	
	DE pulse width	T <sub>DEH</sub>	-	800	-	T <sub>CPH</sub>	
	DE frame blanking	T <sub>DEB</sub>	10	45	110	T <sub>DEH</sub> +T <sub>DEL</sub>	
	DE frame width	T <sub>DE</sub>	-	480	-	T <sub>DEH</sub> +T <sub>DEL</sub>	
	DE setup time	T <sub>esu</sub>	6	-	-	ns	
Data	Data setup time	T <sub>dsu</sub>	6	-	-	ns	
	Data hold time	T <sub>dhd</sub>	6	-	-	ns	

3.2.2 Timing Characteristic

3.2.2.1 DE and RGB Data Input Timing

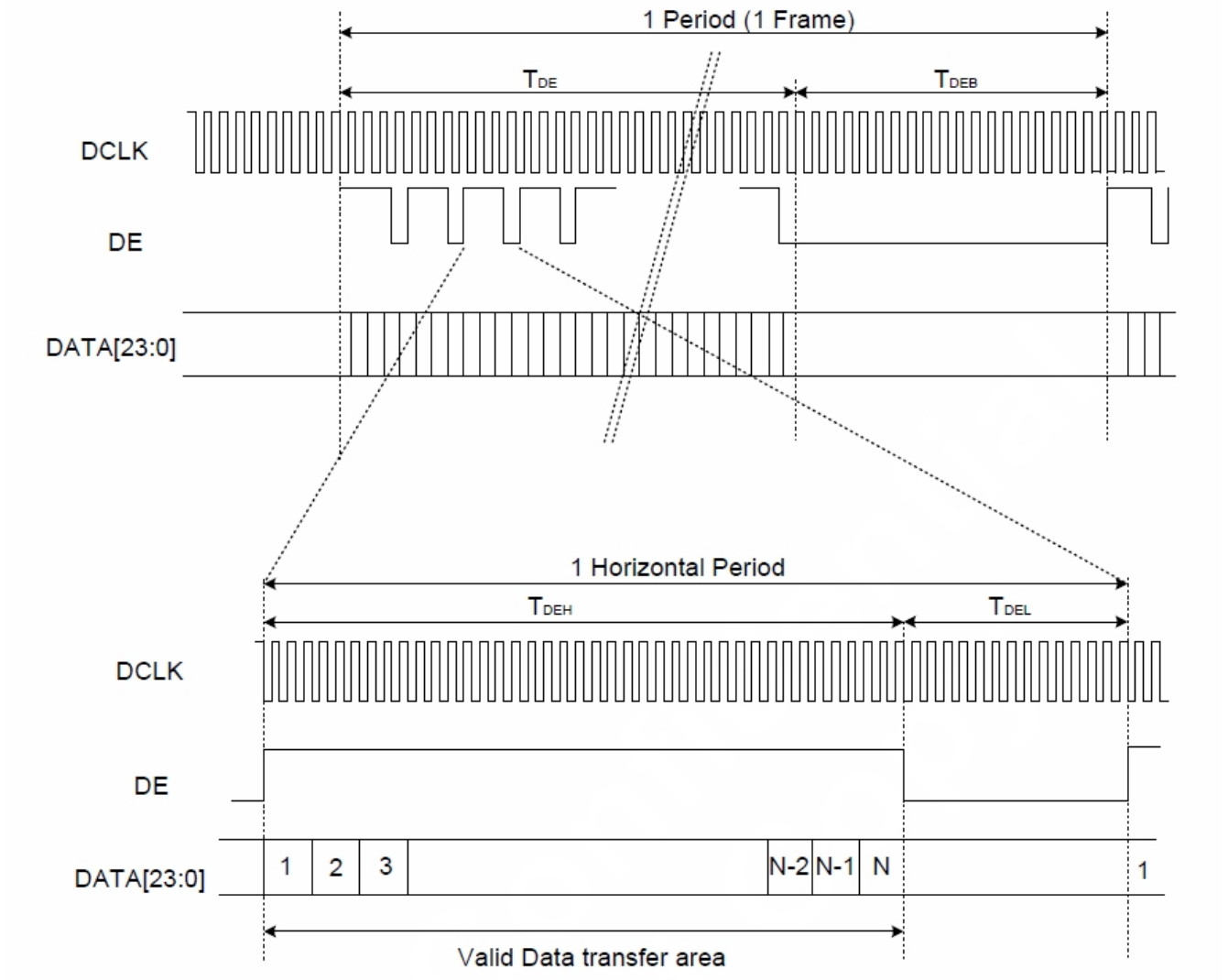

3.2.2.2 Clock and Data input waveforms

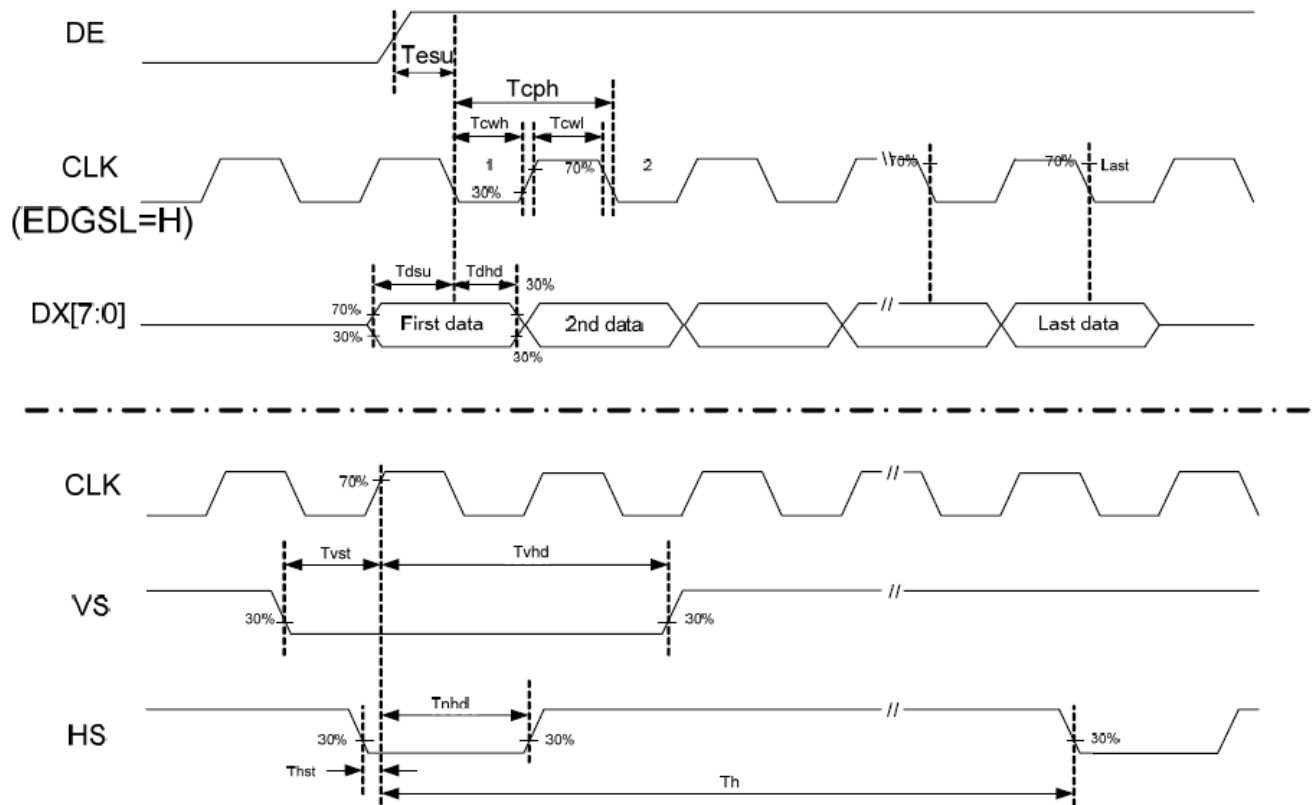

3.3 LVDS Switching Characteristics

3.3.1 LVDS Timing Condition

Symbol	Parameter	Min.	Typ.	Max.	Unit.	Note
tRCP	CLK OUT Period	VCC = 3.0 - 3.6V	11.76	T	50.0	ns
		VCC = 2.5 - 3.6V	14.28	T	50.0	ns
tRCH	CLK OUT High Time	-	4T/7	-	ns	
tRCL	CLK OUT Low Time	-	3T/7	-	ns	
tRCD	RCLK +/- to CLK OUT Delay	-	5T/7	-	ns	
tRS	TTL Data Setup to CLK OUT	0.35T-0.3	-	-	ns	
tRH	TTL Data Hold from CLK OUT	0.45T-1.6	-	-	ns	
tTLH	TTL Low to High Transition Time	-	2.0	3.0	ns	
tTHL	TTL High to Low Transition Time	-	1.8	3.0	ns	
tRIP1	Input Data Position0 (T = 11.76ns)	-0.4	0.0	0.4	ns	
tRIP0	Input Data Position1 (T = 11.76ns)	T/7-0.4	T/7	T/7+0.4	ns	
tRIP6	Input Data Position2 (T = 11.76ns)	2T/7-0.4	2T/7	2T/7+0.4	ns	
tRIP5	Input Data Position3 (T = 11.76ns)	3T/7-0.4	3T/7	3T/7+0.4	ns	
tRIP4	Input Data Position4 (T = 11.76ns)	4T/7-0.4	4T/7	4T/7+0.4	ns	
tRIP3	Input Data Position5 (T = 11.76ns)	5T/7-0.4	5T/7	5T/7+0.4	ns	
tRIP2	Input Data Position6 (T = 11.76ns)	6T/7-0.4	6T/7	6T/7+0.4	ns	
tRPLL	Phase Lock Loop Set			10.0	ms	



3.3.2 LVDS AC Timing

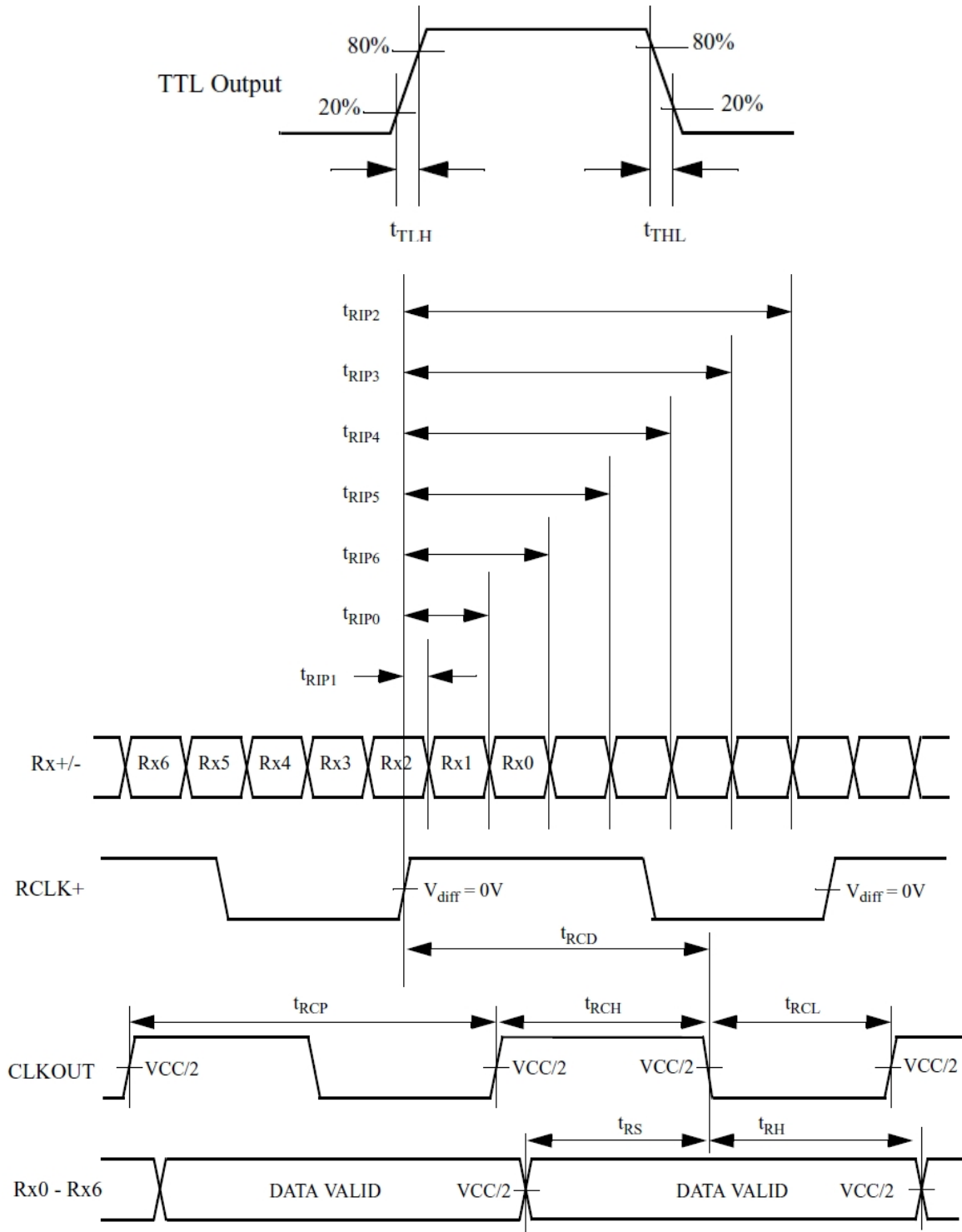

**3.4 Back-Light Unit**

The Back-light system is an edge-lighting type with 30 white LED (Light Emitting Diode)s. The characteristics of 30 white LEDs are shown in the following tables.

(Ta= Room Temp)

Characteristics	Symbol	Min.	Typ.	Max.	Unit	Note
Forward Voltage	VB	8.4	9.9	10.5	V	
Forward Current	IB	-	200	-	mA	(1)
Power Consumption	P <sub>BL</sub>	-	1980	-	mW	(2)
LED Life time	-	50000	-	-	hr	(3)

Note (1) LEDs in 3 series x 10 parallel type.

(2) Where IB = 200mA, VB = 9.9, P<sub>BL</sub> = VB × IB

(3) The environmental conducted under ambient air flow ,at Ta=25±2°C, 60%RH±5%

**4. Optical Characteristics**

**4.1 Optical characteristic of the LCD**

The following items are measured under stable conditions. The optical characteristics should be measured in a dark room or equivalent state with the methods.

Measuring equipment: BM-7A

Item	Symbol	Condition	Min	Type	Max	Unit	Note
Brightness	B		320	400	--	cd/m <sup>2</sup>	
Response time	T <sub>r</sub>	θ=0°	-	5	10	ms	
	T <sub>f</sub>		--	15	20	ms	
Contrast ratio	CR	At optimized viewing angle	350	400	--	--	
Luminance Uniformity	ΔL		70	75		%	
Color Chromaticity (CIE 1931)	White	W <sub>x</sub>	(0.280)	(0.330)	(0.380)	--	BM-7A
		W <sub>y</sub>	(0.320)	(0.370)	(0.420)		
Viewing Angle (6H)	Hor.	θ <sub>R</sub>	CR≥10	55	65	--	Degree
		θ <sub>L</sub>		55	65	--	
	Ver.	θ <sub>U</sub>		45	55	--	
		θ <sub>D</sub>		55	65	--	

a. Test equipment setup

After stabilizing and leaving the panel alone shall be warmed up for the stable operation of LCM, the measurement should be executed. Measurement should be executed in a stable, windless, and dark room. Optical specifications are measured by Topcon BM-7(fast) with a viewing angle of 2° at a distance of 50cm and normal direction.

b. Definition of response time: Tr and Tf

The response time is defined as the following figure and shall be measured by switching the input signal for "black" and "white".

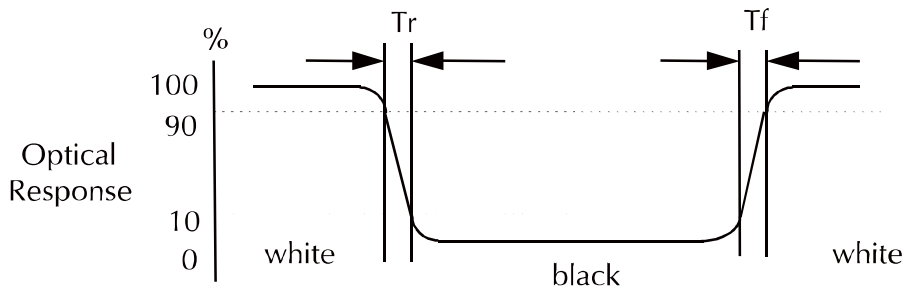

c. Definition of contrast ratio:

$$\text{Contrast Ratio (CR)} = \frac{\text{Brightness measured when LCD is at "white state"}}{\text{Brightness measured when LCD is at "black state"}}$$

d. Measured at the center area of the panel when all the input terminals of LCD panel are electrically opened.

e. View Angle

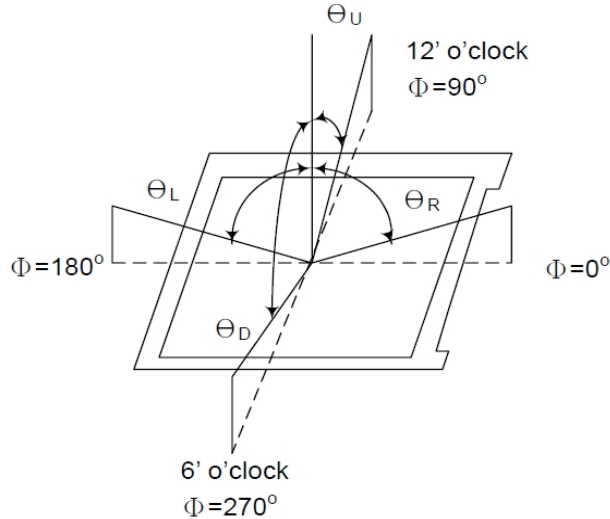

f. Definition of Luminance of White: Luminance of white at the center points

Light Source of Back-Light Unit	LED Type
---------------------------------	----------

g. Definition of White Uniformity

$$\text{White Uniformity} = \frac{\text{Min. luminance of white among 9-points}}{\text{Max. luminance of white among 9-points}} \times 100\%$$

h. The definition of Color Gamut -Color Chromaticity CIE 1931

Color coordinate of white & red, green, blue at center point.

Color Gamut : NTSC(%) = ( RGB Triangle Area / NTSC Triangle Area ) x 100

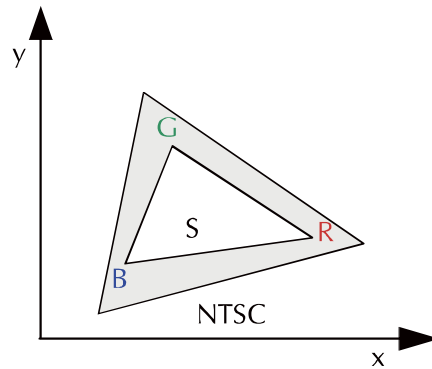

## 5. I/O Terminal

## 5.1 Pin Assignment (connector part No: MSB24013P20A or equivalent.)

Pin No.	Symbol	I/O	Function	Remark
1	VCC	P	Power Supply +3.3V	
2	VCC	P	Power Supply +3.3V	
3	VSS	P	Ground	
4	VSS	P	Ground	
5	RIN0-	I	Negative LVDS differential data input	
6	RIN0+	I	Positive LVDS differential data input	
7	VSS	P	Ground	
8	RIN1-	I	Negative LVDS differential data input	
9	RIN1+	I	Positive LVDS differential data input	
10	VSS	P	Ground	
11	RIN2-	I	Negative LVDS differential data input	
12	RIN2+	I	Positive LVDS differential data input	
13	VSS	P	Ground	
14	RCLK-	I	Negative LVDS differential clock input	
15	RCLK+	I	Positive LVDS differential clock input	
16	VSS	P	Ground	
17	NC	-	NO Connect	
18	NC	-	NO Connect	
19	VSS	P	Ground	
20	VSS	P	Ground	

I: Input, P: Power

Notes:

- 1) NC Pin must be retained; this pin can't contact VSS or other signal.
- 2) VSS Pin must ground contact, can not be floating.

## 5.2 Back Light Unit (Connector Part No: JST:BHSR-02VS-01(N) or equivalent.)

Pin No.	Symbol	Function	Remark
1	LEDA	Power Supply for LED backlight	RED
2	LEDK	GND for LED backlight	BLACK

5.3 Touch Panel Unit (Connector Part No: CVILUX CF25041D0R0-10)

Pin No.	Symbol	Function	Remark
1	XR	Touch panel Right	
2	YU	Touch panel Top	
3	XL	Touch panel Left	
4	YD	Touch panel Bottom	

5.4 Block Diagram

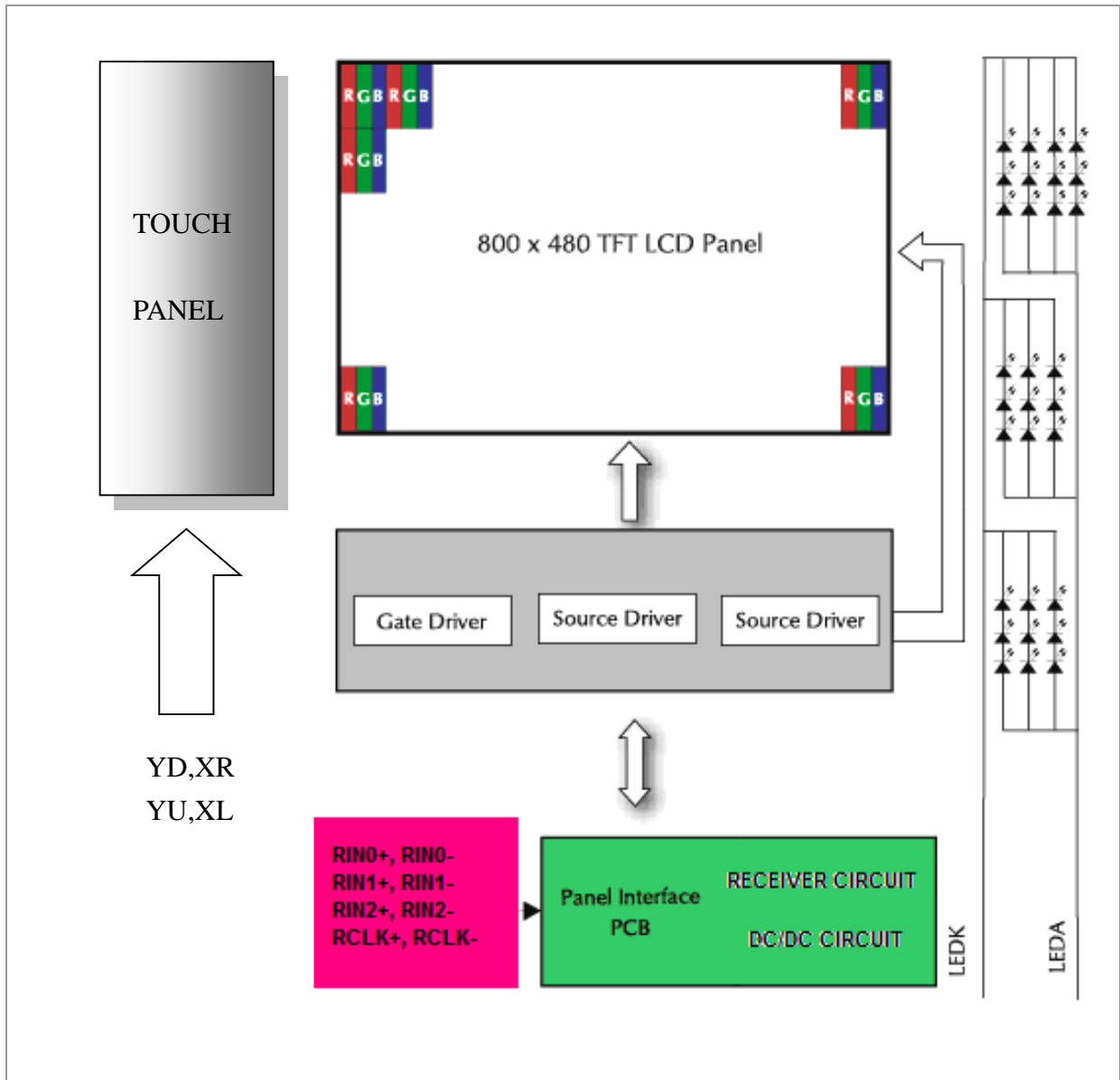

6. Displayed Color and Input Data

	Color & Gray Scale	Data Signal																	
		R5	R4	R3	R2	R1	R0	G5	G4	G3	G2	G1	G0	B5	B4	B3	B2	B1	B0
Basic Color	Black	0	0	0	0	0	0	0	0	0	0	0	0	0	0	0	0	0	0
	Red(0)	1	1	1	1	1	1	0	0	0	0	0	0	0	0	0	0	0	0
	Green(0)	0	0	0	0	0	0	1	1	1	1	1	1	0	0	0	0	0	0
	Blue(0)	0	0	0	0	0	0	0	0	0	0	0	0	1	1	1	1	1	1
	Cyan	0	0	0	0	0	0	1	1	1	1	1	1	1	1	1	1	1	1
	Magenta	1	1	1	1	1	1	0	0	0	0	0	0	1	1	1	1	1	1
	Yellow	1	1	1	1	1	1	1	1	1	1	1	1	0	0	0	0	0	0
	White	1	1	1	1	1	1	1	1	1	1	1	1	1	1	1	1	1	1
Red	Black	0	0	0	0	0	0	0	0	0	0	0	0	0	0	0	0	0	0
	Red(62)	0	0	0	0	0	1	0	0	0	0	0	0	0	0	0	0	0	0
	Red(61)	0	0	0	0	1	0	0	0	0	0	0	0	0	0	0	0	0	0
	:	:	:	:	:	:	:	:	:	:	:	:	:	:	:	:	:	:	:
	Red(31)	0	1	1	1	1	1	0	0	0	0	0	0	0	0	0	0	0	0
	:	:	:	:	:	:	:	:	:	:	:	:	:	:	:	:	:	:	:
	Red(1)	1	1	1	1	1	0	0	0	0	0	0	0	0	0	0	0	0	0
	Red(0)	1	1	1	1	1	1	0	0	0	0	0	0	0	0	0	0	0	0
Green	Black	0	0	0	0	0	0	0	0	0	0	0	0	0	0	0	0	0	0
	Green(62)	0	0	0	0	0	0	0	0	0	0	0	1	0	0	0	0	0	0
	Green(61)	0	0	0	0	0	0	0	0	0	0	1	0	0	0	0	0	0	0
	:	:	:	:	:	:	:	:	:	:	:	:	:	:	:	:	:	:	:
	Green(31)	0	0	0	0	0	0	0	1	1	1	1	0	0	0	0	0	0	0
	:	:	:	:	:	:	:	:	:	:	:	:	:	:	:	:	:	:	:
	Green(1)	0	0	0	0	0	0	1	1	1	1	1	0	0	0	0	0	0	0
	Green(0)	0	0	0	0	0	0	1	1	1	1	1	1	0	0	0	0	0	0
Blue	Black	0	0	0	0	0	0	0	0	0	0	0	0	0	0	0	0	0	0
	Blue(62)	0	0	0	0	0	0	0	0	0	0	0	0	0	0	0	0	0	1
	Blue(61)	0	0	0	0	0	0	0	0	0	0	0	0	0	0	0	0	1	0
	:	:	:	:	:	:	:	:	:	:	:	:	:	:	:	:	:	:	:
	Blue(31)	0	0	0	0	0	0	0	0	0	0	0	0	0	1	1	1	1	1
	:	:	:	:	:	:	:	:	:	:	:	:	:	:	:	:	:	:	:
	Blue(1)	0	0	0	0	0	0	0	0	0	0	0	0	1	1	1	1	1	0
	Blue(0)	0	0	0	0	0	0	0	0	0	0	0	0	1	1	1	1	1	1

0 : Low level voltage, 1 :High level voltage

Each basic color can be displayed in 64 gray scales from 6 bit data signals. With the combination of total 18 bit data signals, the 262,144-color display can be achieved on the screen.

**7. Touch Screen Panel Specifications****7.1 Touch Panel****7.1.1 Electrical Characteristics**

Item	Min.	Typ.	Max.	Unit	Note
Linearity	-2	-	2	%	Analog X and Y directions
Terminal resistance	200	-	1000	$\Omega$	Y(Glass side)
	200	-	1000	$\Omega$	X(Film side)
Insulation resistance	20	-	-	M $\Omega$	DC 25V
Voltage	3.0	-	5.0	V	DC
Response time	-	-	10	$\leq$ ms	

**7.1.2 Mechanical & Reliability Characteristics**

Item	Min.	Typ.	Max.	Unit	Note
Activation force	60	-	100	g	(1)
Hitting Durability	1,000,000	-	-	times	(2)
Sliding Durability	100,000			times	
Surface hardness	3	-	-	H	JIS K5400

Note (1) Input : Finger or polyacetal pen 0.8R

Note (2) Pit 1,000,000 times on the Film with a R8.0 (Hardness 60°) silicon rubber.

- Force : Force : 250g



**7.2 Housing Design Guide**

Housing design follow as below.

- 1) Avoid the design that housing overlap and press on the active area of the LCM.
- 2) Give enough gap(over 0.5mm at compressed) between the housing and TSP to protect wrong operating.

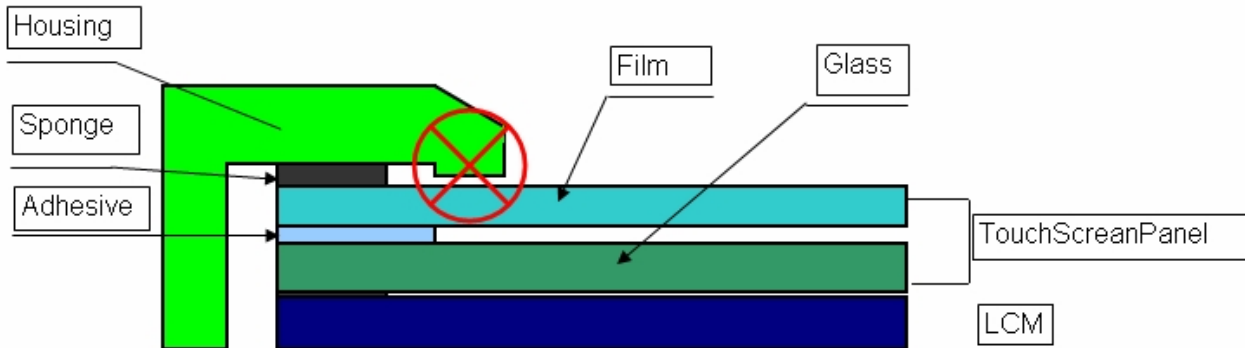

- 3) Use a buffer material(Gasket) between the TSP and housing to protect damage and wrong operating.
- 4) Avoid the design that buffer material overlap and press on the inside of TSP view area.

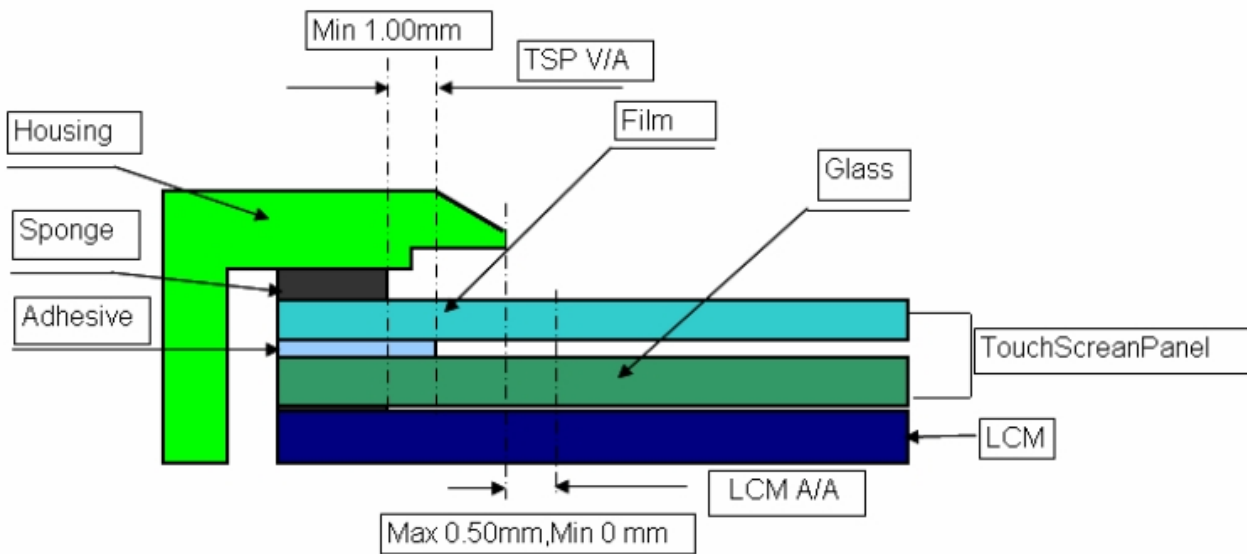

**8. Reliability Condition**

No change on display and in operation under the following test condition.

Condition: Unless otherwise specified, tests will be conducted under the following condition.

Temperature: 20±5°C.

Humidity: 65±5%RH.

Tests will be not conducted under functioning state.

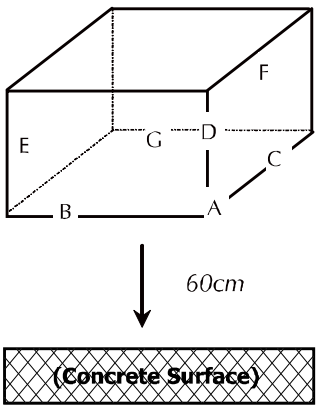
No.	Parameter	Condition	Notes
1	High Temperature Operating	70°C±2°C, 240hrs (Operation state).	
2	Low Temperature Operating	-20°C±2°C, 240hrs (Operation state).	1
3	High Temperature Storage	80°C±2°C, 240hrs.	2
4	Low Temperature Storage	-30°C±2°C, 240hrs.	1,2
5	High Temperature and High Humidity Operation Test	60°C±2°C, 90%, 240hrs.	1,2
6	Vibration Test	Total fixed amplitude: 1.5mm. Vibration Frequency: 10~55Hz. One cycle 60 seconds to 3 direction of X, Y, Z each 15 minutes.	3
7.	Thermal Shock Test	-30°C (30min) ~ 80°C (30min), 10 cycles	
8.	Drop Test	<p>To be measured after dropping from 60cm high on the concrete surface in packing state.</p>  <p><i>Dropping method corner dropping:</i></p> <p><i>A corner: Once edge dropping.</i></p> <p><i>B, C, D edge: Once face dropping.</i></p> <p><i>E, F, G face: Once.</i></p>	

- Notes:
1. No dew condensation to be observed.
  2. The function test shall be conducted after 4 hours storage at the normal temperature and humidity after removed from the test chamber.
  3. Vibration test will be conducted to the product itself without putting I in a container.

9. Dimensional Outlines

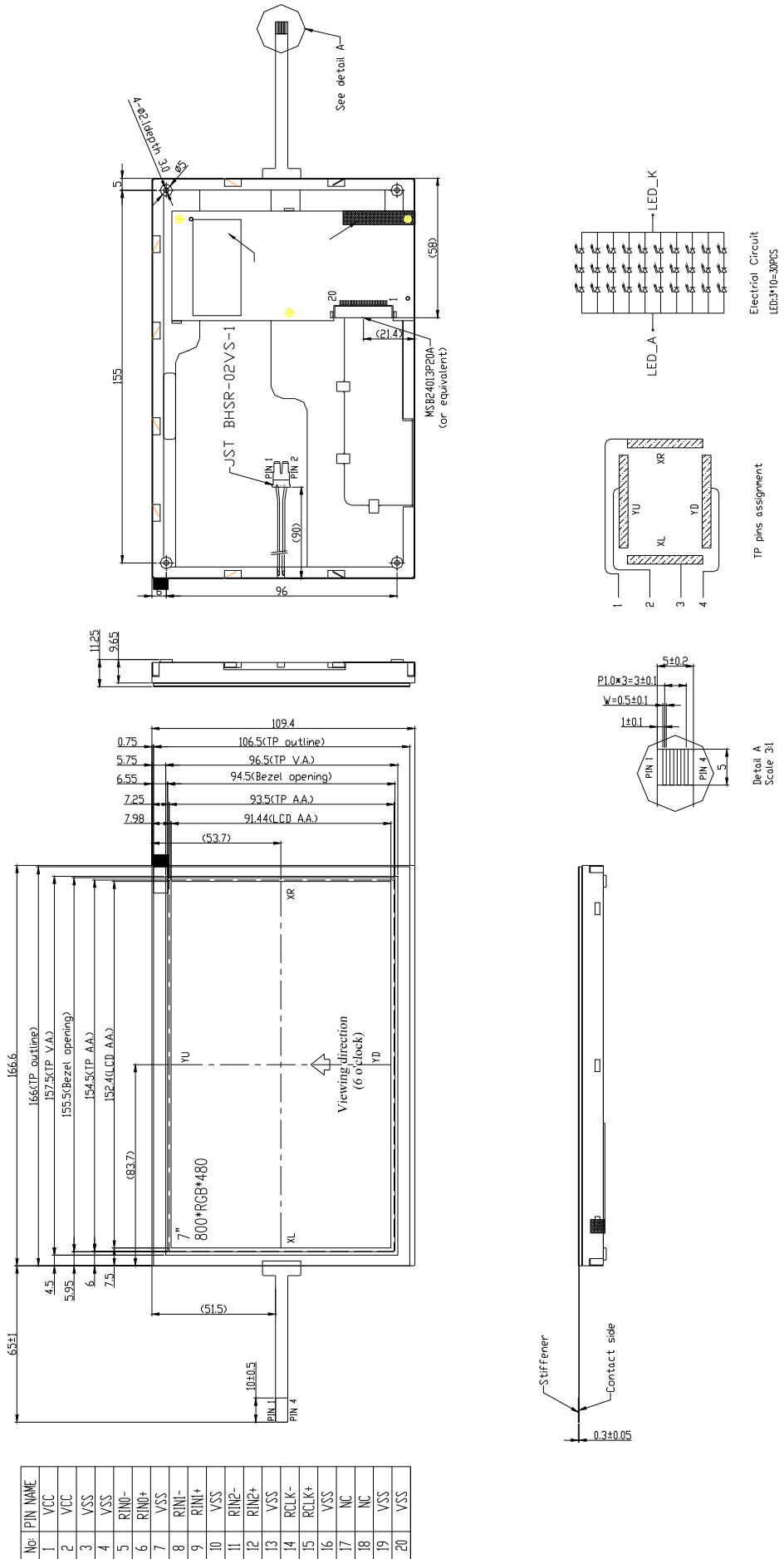

No.	PIN NAME
1	VCC
2	VCC
3	VSS
4	VSS
5	RIN0-
6	RIN0+
7	VSS
8	RIN1-
9	RIN1+
10	VSS
11	RIN2-
12	RIN2+
13	VSS
14	RCLK-
15	RCLK+
16	VSS
17	NC
18	NC
19	VSS
20	VSS

10. Incoming Inspection Standards

10.1 Inspection and Environment Conditions

10.1.1 Inspection Conditions:

- (1) Inspection Distance: 35 cm±5cm
- (2) View Angle : Light-on Inspection Angle : ±5°  
Cosmetic Inspection Angle : ±45°

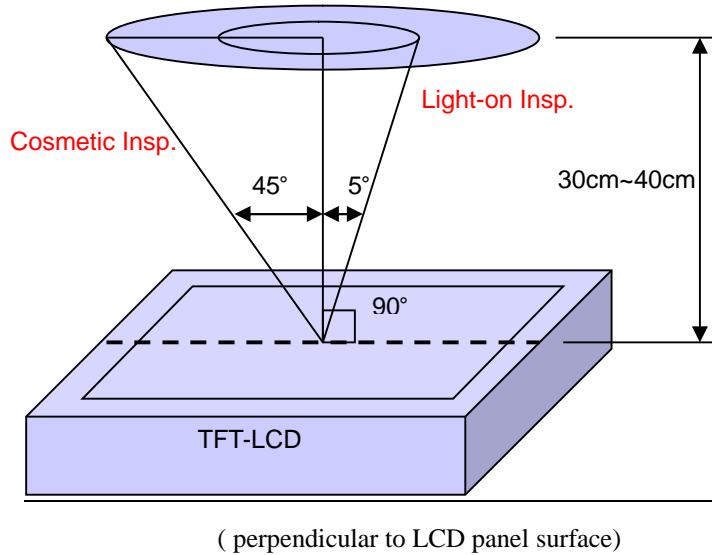

10.1.2 Environment Conditions:

Ambient Temperature		23°C±5°C
Ambient Humidity		55±10%RH
Ambient Illumination	Cosmetic Inspection	more than 600 Lux
	Functional Inspection	300~500 Lux

10.1.3 Sampling Conditions:

- (1) Lot Size: Quantity of shipment lot per model
- (2) Sampling Method:

Sampling Plan		MIL-STD-105E
		Normal Inspection, Single Sampling
		Level II
AQL	Major Defect	1.0%
	Minor Defect	1.5%

- (3) The classification of Major(MA) and Minor(MI) defects is shown as 3. Inspection Criteria.

10.1.4 Inspection Criteria

10.1.4.1 Cosmetic Inspection (Panel):

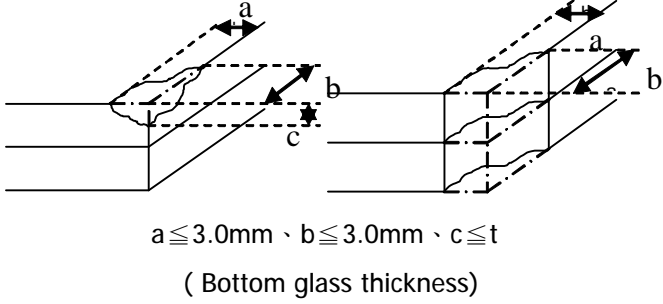
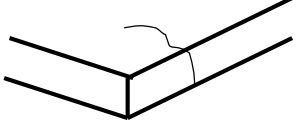
Item	Judgment Criteria	Classification
Chipping on Panel	 <p><math>a \leq 3.0\text{mm}</math>、<math>b \leq 3.0\text{mm}</math>、<math>c \leq t</math> ( Bottom glass thickness)</p>	MA
Scratch on Panel *Note-2	<p><math>W \leq 0.05\text{mm}</math> or <math>L &lt; 5\text{mm}</math>: Ignored  <math>0.05\text{mm} &lt; W \leq 0.1\text{mm}</math> and <math>L \leq 5\text{mm}</math>: <math>N \leq 5</math>  <math>W &gt; 0.1\text{mm}</math> or <math>L &gt; 5\text{mm}</math>: Not allowed</p>	MI
Bubble or Dent on Panel *Note-3	<p><math>D \leq 0.2\text{mm}</math>: Ignored  <math>0.2\text{mm} &lt; D \leq 0.3\text{mm}</math>: <math>N \leq 5</math>  <math>D &gt; 0.3\text{mm}</math>: Not allowed</p>	MI
Panel Crack	 <p>Not Allowed crack</p>	MA
Bezel Deformation	Obvious deformation is not allowed.	MI
Bezel Oxidation	Not allowed if it rusts continuously over 1 cm (It is out of warranty with rusted tin plate)	MI
Bezel Scratch	$L \leq 20\text{mm}$ , $W \leq 0.2$ , $N \leq 3$	MI
Metal Squash Dent /Flange(Front Side)	$D(W) \leq 1, L \leq 3, N \leq 3;$	MI
B/L High Voltage Wire Denudation	Not allowed	MA
Polarizer flaw or leak out resin	Defect is defined as the active area.	MI
Outline Dimension	Must in Spec, refer to related product spec.	MI

10.1.4.2 Functional Inspection:

Item	Judgment Criteria			Classification	
	Area(Note1)	I	O		
Point Defect	Bright dot	Random	2		MI
		2 dots adjacent	0	0	
		3 dots adjacent or more	0	0	
	Dark dot	Random	3		
		2 dots adjacent	0		
		3 dots adjacent or more	0	0	
	Total Dot Defect		5		
	Distance	Distance between Bright and Bright dot	$L \geq 5\text{mm}$		
		Distance between Bright and Dark dot	$L \geq 5\text{mm}$		
		Distance between Dark dot	$L \geq 5\text{mm}$		
(1) It is defined as Point Defect if defect area > 0.5dot (2) It is ignored if defect area $\leq 0.5\text{dot}$ (3) Weak point defect will be defined as Bright Dot if it can be observed through ND filter 5% ( Full Screen Black Inspection)					
Line Defect	Obvious vertical or horizontal line defect is not allowed.			MA	
Mura	Not allowed if it can be observed through ND Filter 5 %			MI	
Foreign Material in spot shape *Note-3	$D \leq 0.2\text{mm}$ : Ignored $0.2\text{mm} < D \leq 0.5\text{mm}$ : $N \leq 8$ $D > 0.5\text{mm}$ : Not allowed			MI	
Foreign Material in line or spiral shape *Note-4	$W \leq 0.05\text{mm}$ or $L \leq 5\text{mm}$ : Ignored $0.05\text{mm} < W \leq 0.2\text{mm}$ and $L 1.0\text{mm} \leq 5\text{mm}$ : $N \leq 8$ $W > 0.2\text{mm}$ or $L > 5\text{mm}$ : Not allowed			MI	
Display Function Abnormal	No Malfunction can be allowed			MA	

Note-1 : I/O Area Definition

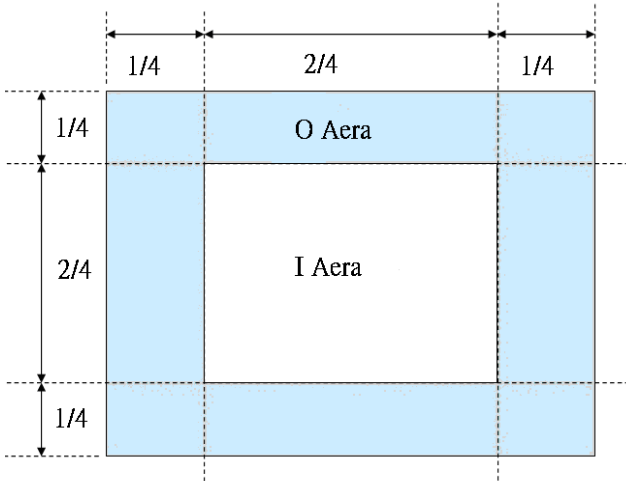

Note-2 : Polarizer Scratch

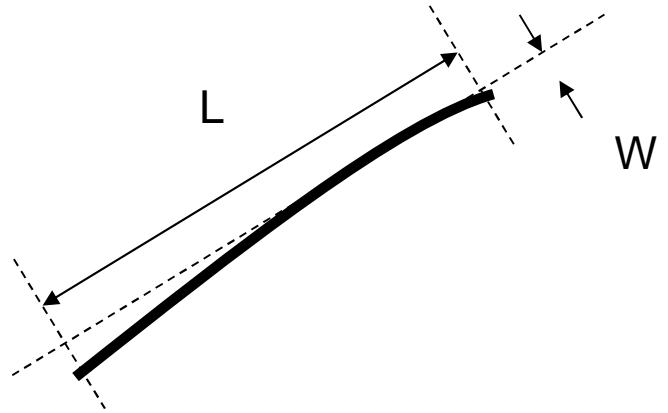

Note-3 : Spot Foreign Material  
( $W \geq L / 4$ )

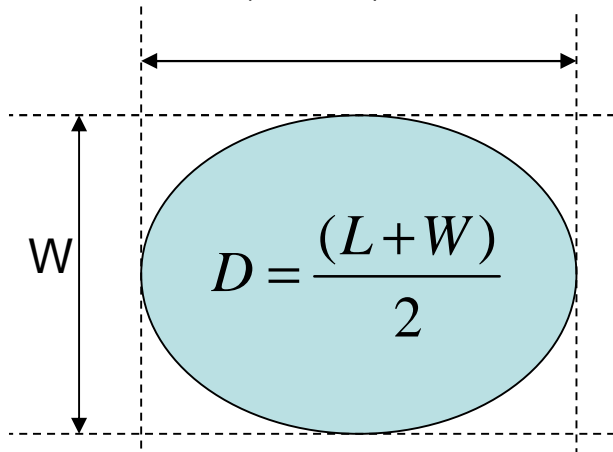

Note-4 : Line or Spiral Foreign Material  
( $W < L / 4$ )

