



eCONTROL - Universal controller

- Continuous, 2-point, 3-point and On/Off control
- Ratio control function
- Sensor inputs (4-20 mA, 0-10 V, frequency, RTD)
- Control of proportional, process and motor valves
- Bürkert proportional valves and flow meters are memorized

Product variants described in the data sheet may differ from the product presentation and description.

Can be combined with

| | |
|---|---|
|  | Type 2301 + 8696 ▶ Globe control valve system |
|  | Type 8012 ▶ Flowmeter with paddle wheel for continuous flow measurement |
|  | Type 6223 ▶ Servo-assisted 2-way high-flow solenoid control valve |
|  | Type 8316 ▶ Pressure transmitter 4...20 mA |
|  | Type 8222 ▶ Conductivity meter |
|  | Type TST001 ▶ Resistance thermometer |

Type description

Thanks to its compact design, the universal 8611 controller is especially designed for compact control system applications. It is compatible and tested with all Bürkert proportional valves and sensors and can be connected with every non-Bürkert Control valve by standard signal (4...20 mA, 0...10 V or PWM-output).

The Proportional & Integral (PI) process controller is equipped with many additional functions. The process value feedback can be supplied as one of three analogue inputs; a standard signal (4...20 mA/0...10 V), frequency or RTD signal; directly to the universal controller.

The process switching points can be set via a 4...20 mA or 0...10 V signal or with the keypad. For temperature specific control, it is possible to set a cascade structure with both temperature and flow as inputs.

Thanks to the proportional control capabilities, a wide range of control functions can be performed in a variety of liquids and gas mediums.

DTS 1000089169 EN Version: W Status: RL (released | freigegeben | valide) printed: 14.09.2020

Table of contents

| | |
|--|-----------|
| 1. General technical data | 3 |
| 2. Dimensions | 5 |
| 2.1. Fitting-mounting | 5 |
| 2.2. Valve-mounting | 6 |
| 2.3. Panel-mounting..... | 6 |
| 2.4. Wall-mounting..... | 7 |
| 2.5. Rail-mounting | 7 |
| 3. Device/Process connections | 8 |
| 3.1. Connection feasibility and controller versions | 8 |
| 4. Product installation | 9 |
| 4.1. Mounting options..... | 9 |
| 5. Product design and assembly | 10 |
| 5.1. Fields of application..... | 10 |
| 5.2. Application examples..... | 10 |
| 6. Ordering information | 12 |
| 6.1. Bürkert eShop – Easy ordering and quick delivery..... | 12 |
| 6.2. Bürkert product filter | 12 |
| 6.3. Ordering chart..... | 13 |
| 6.4. Ordering chart accessories..... | 14 |
| 6.5. Ordering chart spare parts..... | 15 |

1. General technical data

| Product properties | |
|---|---|
| Dimensions | Detailed information can be found in chapter "2. Dimensions" on page 5. |
| Material | |
| Housing, cover | PC, +20 % glass fibre |
| Front panel folio | Polyester |
| Screws | Stainless steel |
| Multipin | CuZn, nickel-plated |
| Wall-mounting holder | PVC |
| Display | Dual-line 8-digit LCD with backlight |
| Electrical data | |
| Operating voltage | 24 V DC \pm 10 %, filtered and regulated |
| Power consumption | Approx. 2 W (without valve - without sensor input) |
| Voltage supply cable | 0.5 mm ² max. cross section, max. 100 m, shielded |
| Electrical connections | Multipin: M12-8 pin, M8-4 pin, M8-3 pin Terminals Insert for connecting to components according to DIN EN 175301-803 |
| Controller modes | PI-Control, 2 point and 3 point, cascaded Up to 2 Binary out with windows and hysteresis mode |
| Input | |
| Setpoint | |
| Standard 4...20 mA | Sourcing mode Max. input impedance: 70 Ω Resolution: 5.5 μ A |
| Standard 0...10 V | Max. input impedance: 11.5 k Ω Resolution: 2.5 mV |
| Sensors | |
| Standard 4...20 mA | Sourcing mode Max. input impedance: 70 Ω Resolution: 5.5 μ A |
| Standard 0...10 V | Max. input impedance: 11.5 k Ω Resolution: 2.5 mV |
| Frequency | |
| Input 1 | External sensor Min. 0.25 Hz / max. 1 kHz Input impedance: > 1 k Ω Signal type: Sinus, square, triangle pulse (>3000 mVpp, max. 30 Vpp) |
| Input 2 | Internal Hall sensor Min. 0.25 Hz / max. 1 kHz (only with Bürkert Type S030 flow fitting) |
| Pt100 (2 wires) | Measuring range: 0...+200 $^{\circ}$ C Measuring current: 1 mA Measuring error: <0.5 $^{\circ}$ C |
| Binary input | Input impedance: 10 k Ω Operating threshold: 3...30 V Max. frequency: 1 kHz |
| Output | |
| Power supply sensor / actuator | 24 V DC, max. 1 A |
| Total load of all outputs | Max. 1.5 A |
| Continuous signal | |
| Standard signal 4...20 mA | Max. loop resistance: 680 Ω Accuracy: 0.5 % |
| Standard signal 0...10 V | Max. current: 20 mA Accuracy: 0.5 % |
| Discontinuous signal | |
| 2 transistor outputs for PWM ¹⁾ (pulse width modulation) or PTM ¹⁾ (pulse time modulation) signal | Control frequency 20 Hz...9999 Hz Resolution max.: 16 Bit (depending on frequency) Max. current load: 1.5 A Switching voltage: 24 V DC |
| Binary output | |
| Transistor output (PNP) (configurable) | Max. current load: 1.5 A Switching voltage: 24 V DC |

Approvals and Certificates

| | |
|----------|-------------------|
| Standard | EMC, CE: EN 61326 |
|----------|-------------------|

Environment and installation

| | |
|---------------------------------|-------------------------------------|
| Height above sea level | Max. 2000 m |
| Relative humidity (environment) | ≤ 80 %, without condensation |
| Ambient temperature | 0...+ 70 °C (operating and storage) |
| Degree of protection | IP65 |

- 1.) PWM = pulse width modulation
PTM = pulse time modulation

2. Dimensions

2.1. Fitting-mounting

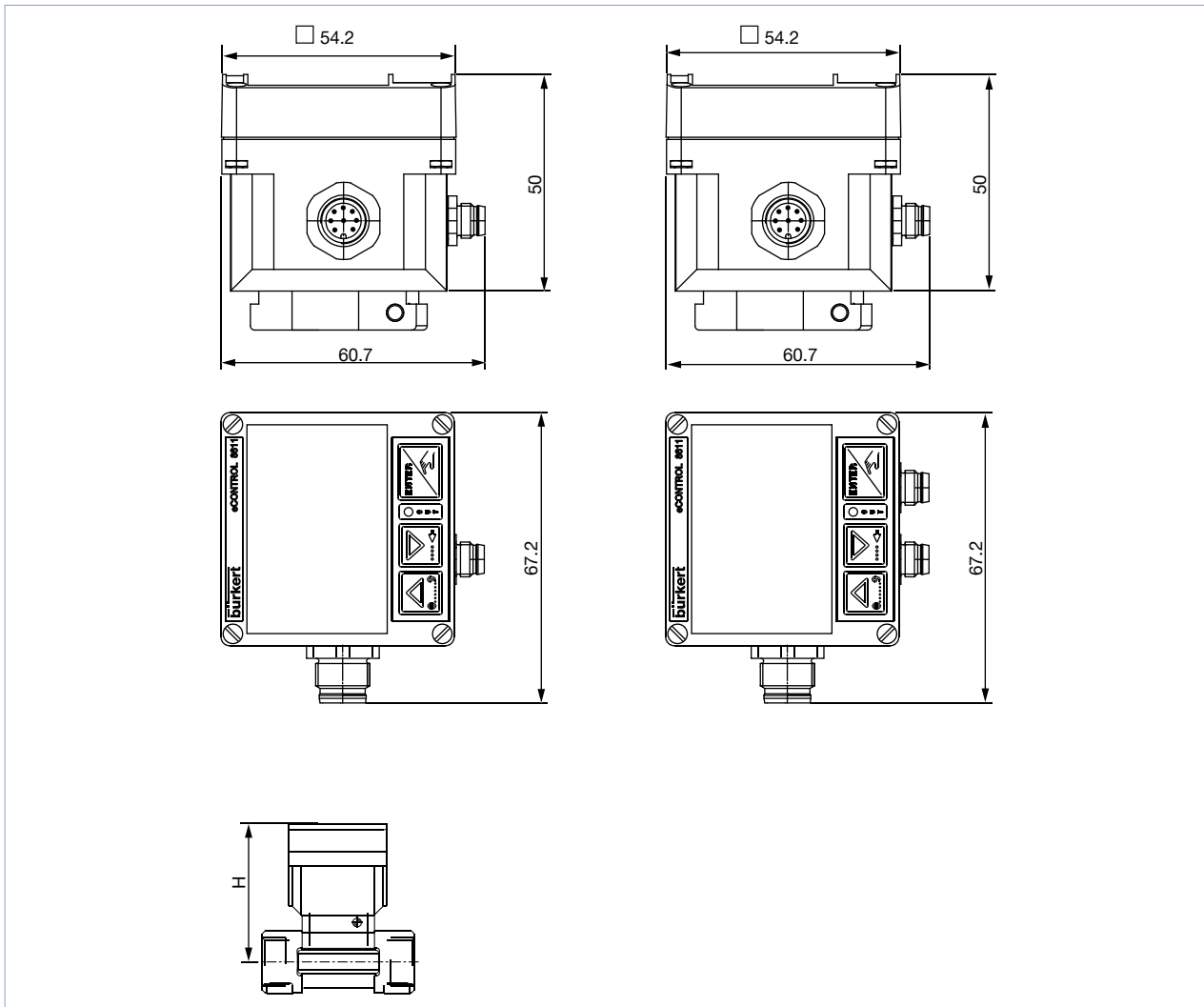

| DN [mm] | H [mm] |
|---------|--------|
| 06 | 79.5 |
| 08 | 79.5 |
| 15 | 84.5 |
| 20 | 82.0 |
| 25 | 82.2 |
| 32 | 85.8 |
| 40 | 89.6 |
| 50 | 95.7 |
| 65 | 98.7 |

2.2. Valve-mounting

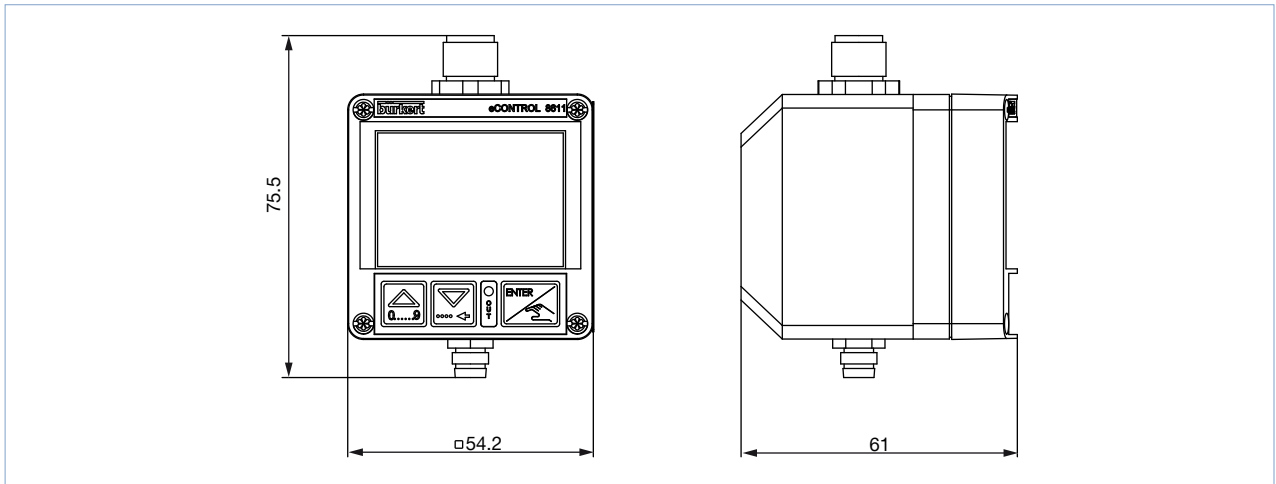

2.3. Panel-mounting

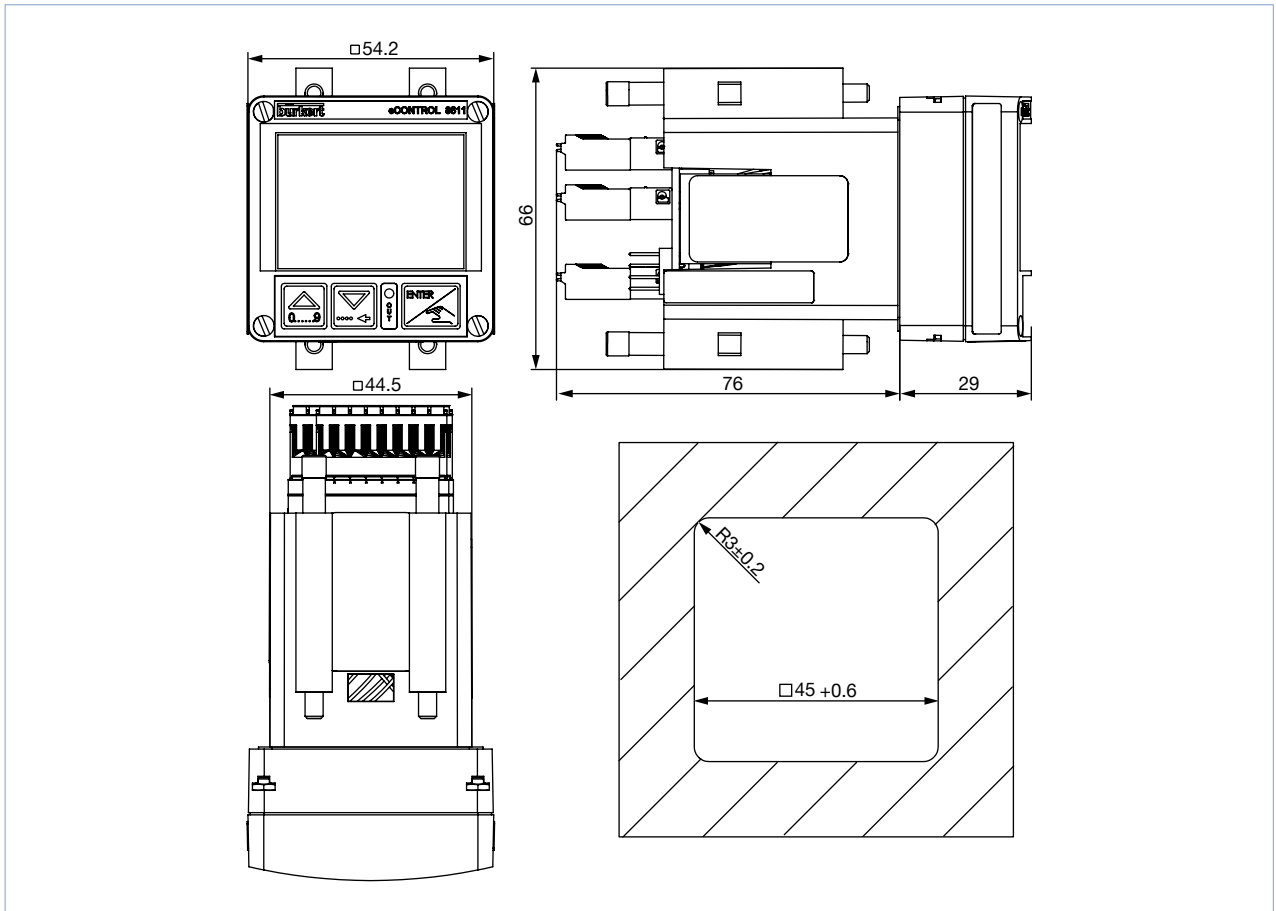

DTS 1000089169 EN Version: W Status: RL (released | freigegeben | valide) printed: 14.09.2020

2.4. Wall-mounting

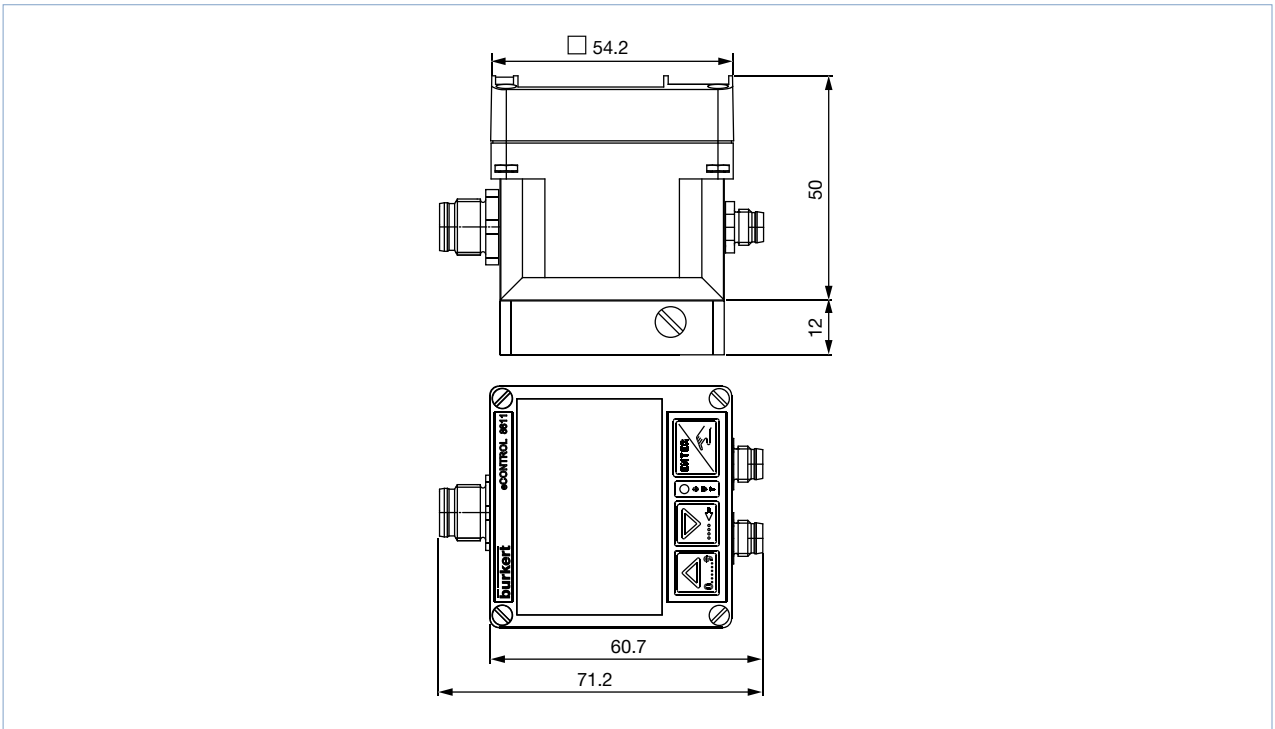

2.5. Rail-mounting

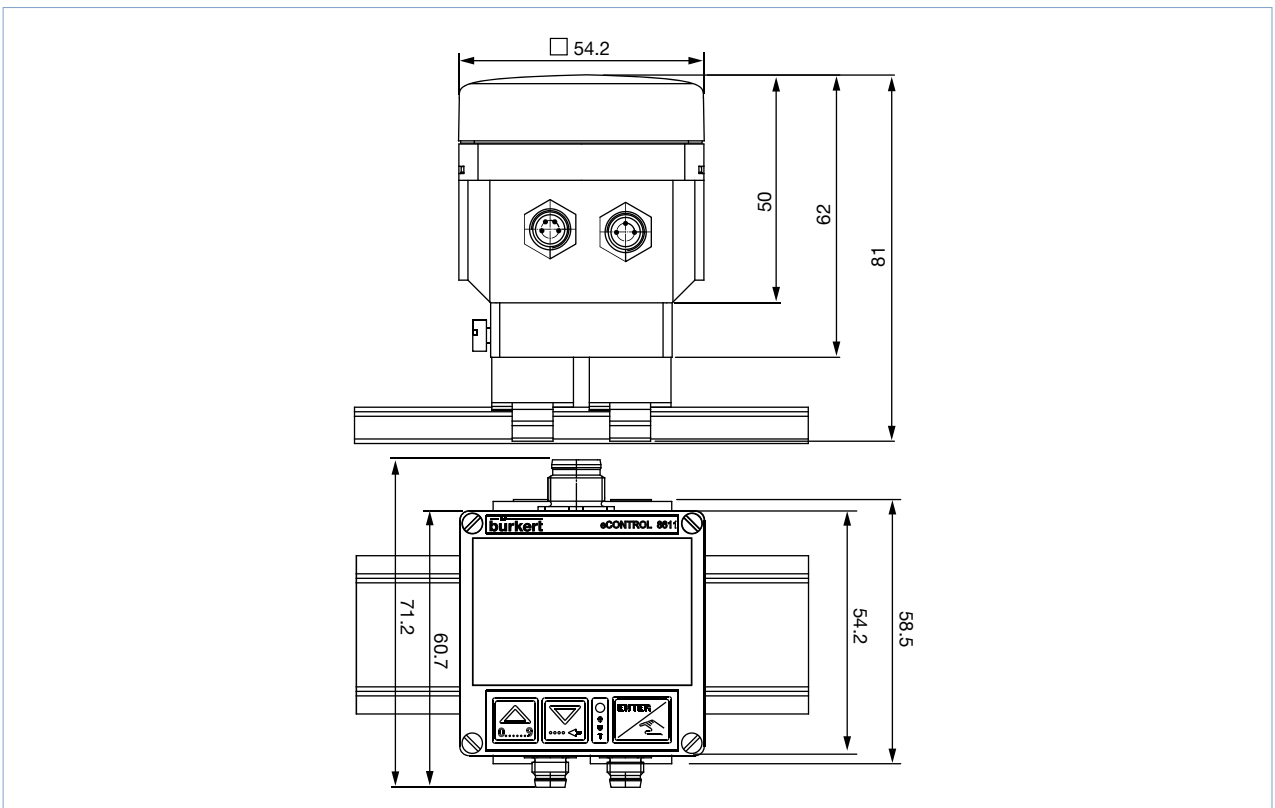

3. Device/Process connections

3.1. Connection feasibility and controller versions

| Assembly | Flow sensor fitting mounting | Wall and rail mounting | Valve mounting |
|----------------|--|---|---|
| Sensor | Integrated HALL-sensor, without external sensor input | Integrated HALL-sensor, with external sensor input | Without HALL-sensor, with external sensor input |
| Control | <ul style="list-style-type: none"> Flow control | <ul style="list-style-type: none"> Temperature control with flow display Temperature control with flow input for cascade control Ratio control | <ul style="list-style-type: none"> Temperature control Pressure control Flow control |
| | <p>8 pin M12 4 pin M8</p> | <p>8 pin M12 4 pin M8 3 pin M8</p> | <p>8 pin M12 3 pin M8</p> |

8 pin M12 plug

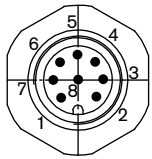

- Power supply 24 V DC
- Set point value (0...10 V / 4...20 mA)
- Binary input
- Process value output (0...10 V / 4...20 mA)
- PI-control output (0...10 V / 4...20 mA)
- Binary output

3 pin M8 plug

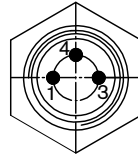

- Sensor input
- 4...20 mA / 0...10 V, frequency or Pt100
- Sensor power supply 24 V DC

4 pin M8 plug

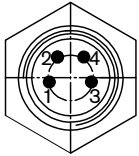

- PI-control output:
- 1 x PWM output
 - 2 x PTM output
 - 0...10 V/4...20 mA output and power supply actuator 24 V DC (only article no. 182383 and 567181)

DIN 175301 - 803

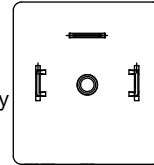

PWM output for Solenoid control valve

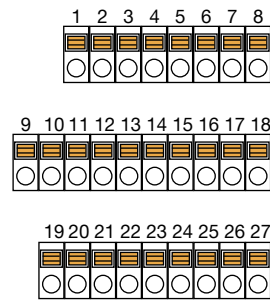

Terminal block 1

Terminal block 2

Terminal block 3

Jumper 1 (NPN/PNP)
Jumper 2 (NPN/PNP)

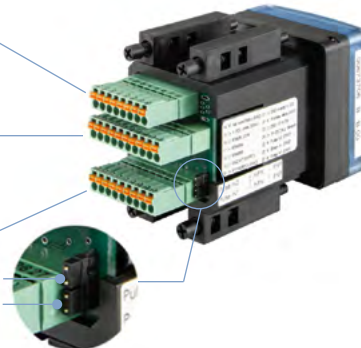

4. Product installation

4.1. Mounting options

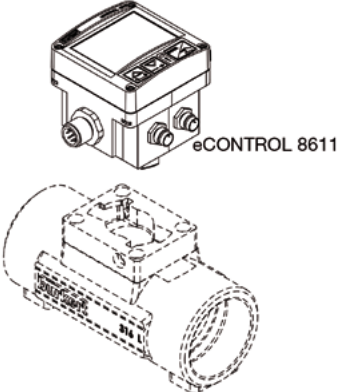
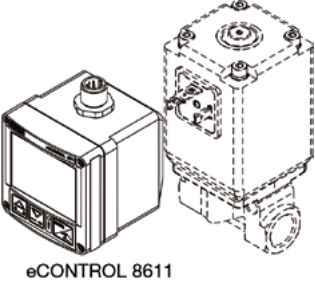
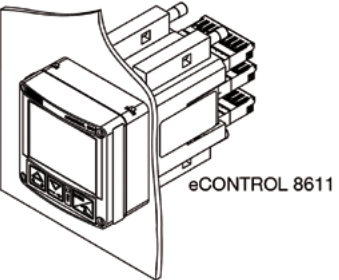
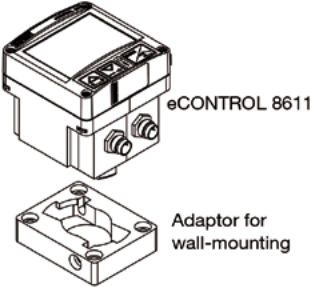
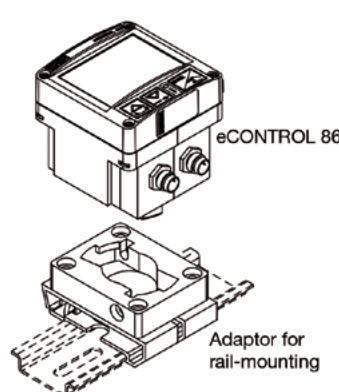
| Mounting on flow-fitting | Mounting on proportional valve |
|---|---|
|  <p>eCONTROL 8611</p> |  <p>eCONTROL 8611</p> |
| Mounting in a panel | Mounting on a wall |
|  <p>eCONTROL 8611</p> |  <p>eCONTROL 8611</p> <p>Adaptor for wall-mounting</p> |
| Mounting on a rail | |
|  <p>eCONTROL 8611</p> <p>Adaptor for rail-mounting</p> | |

DTS 1000089169 EN Version: W Status: RL (released | freigegeben | valide) printed: 14.09.2020

5. Product design and assembly

5.1. Fields of application

- Flow control, Ratio control
- Pressure control
- Temperature control
- Conductivity control
- pH control
- Level control

5.2. Application examples

Cascaded temperature control with process control valve

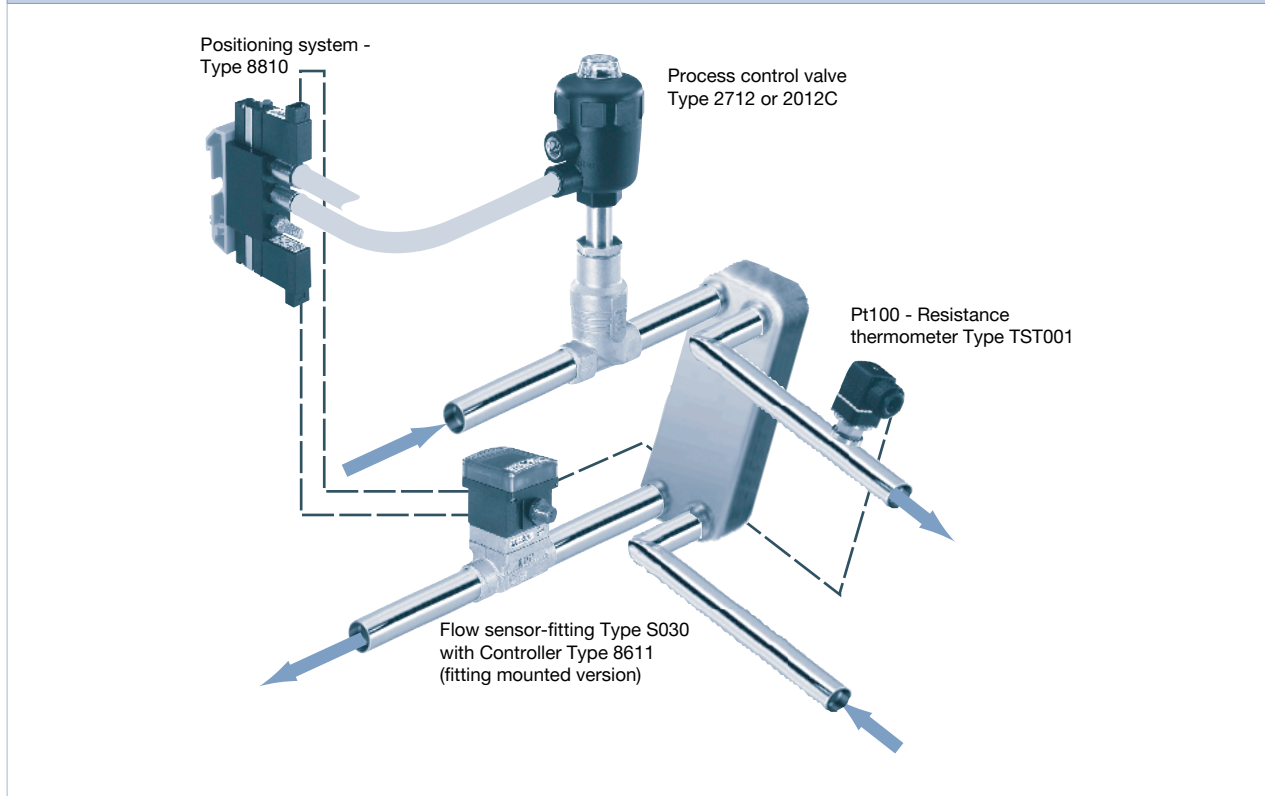

Temperature control with solenoid control valve

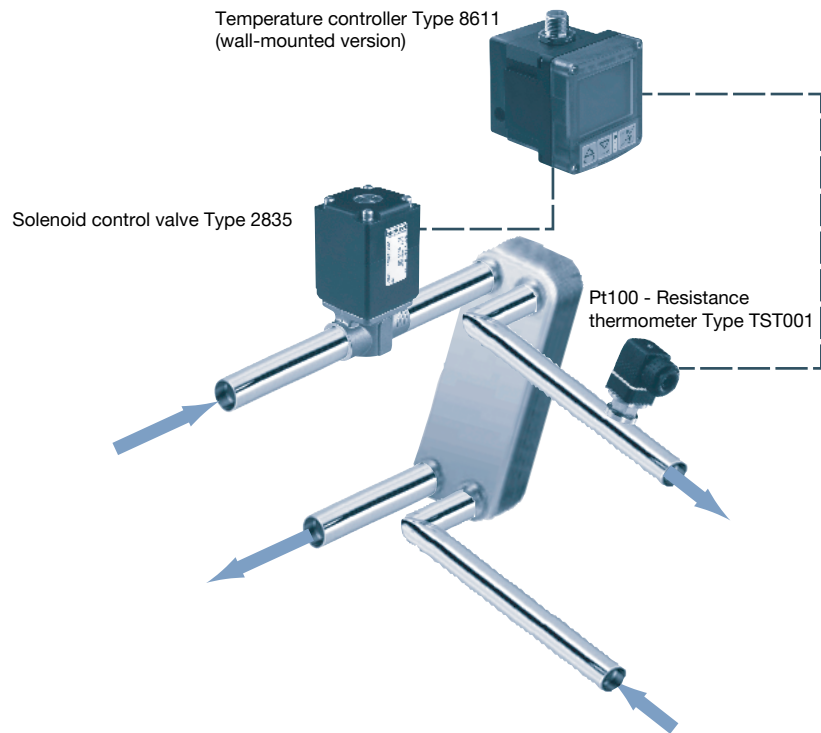

Flow control with process control valve

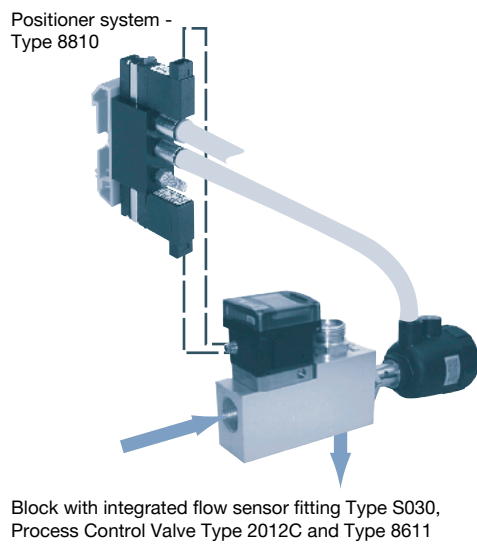

Multi channel solution

With process control valve



With solenoid control valve



6. Ordering information

6.1. Bürkert eShop – Easy ordering and quick delivery



Bürkert eShop – Easy ordering and fast delivery

You want to find your desired Bürkert product or spare part quickly and order directly? Our online shop is available for you 24/7. Sign up and enjoy all the benefits.

[Order online now](#)

6.2. Bürkert product filter



Bürkert product filter – Get quickly to the right product

You want to select products comfortably based on your technical requirements? Use the Bürkert product filter and find suitable articles for your application quickly and easily.

[Try out our product filter](#)

6.3. Ordering chart

A controller Type 8611 consists of:

Fitting-mounting (DN06...DN65)

- An electronic module Typ 8611
- An inline fitting Typ S030 (Refer to corresponding data sheet - has to be ordered separately)

Wall-mounting

- An electronic module Typ 8611
- A wall-mounting adaptor (included)

Rail-mounting













- An electronic module Typ 8611
- A rail-mounted adaptor (included)

Valve-mounting









- An electronic module Typ 8611
- A proportional valve (Refer to corresponding data sheet of the proportional valve - has to be ordered separately)



Panel-mounting

- An electronic module Typ 8611
- 4 mounting brackets and 1 sealing (included)

| Mounting disposition | Sensor input | | Controller outputs ^{1.)} | | Operating voltage | Setpoint setting | Process value output ^{1.)} | Binary In/Out | Article no. |
|---|--------------|---|-----------------------------------|-----------------------|-------------------|-----------------------|-------------------------------------|---------------------------|--|
| | External | | | | | | | | |
|  | – | Flow rate (Fitting S030) | 1 x PWM 2 x PTM | 4...20 mA 0...10 V | 24 V DC | 4...20 mA 0...10 V | 4...20 mA 0...10 V | 1 x Bin In 1 x Bin Out | 177455  |
| | – | Temperature (Pt100) | 1 x PWM 2 x PTM | 4...20 mA 0...10 V | 24 V DC | 4...20 mA 0...10 V | 4...20 mA 0...10 V | 1 x Bin In 1 x Bin Out | 177458  |
| | – | Ratio or Temp. (4...20 mA / 0...10 V) | 1 x PWM 2 x PTM | 4...20 mA 0...10 V | 24 V DC | 4...20 mA 0...10 V | 4...20 mA 0...10 V | 1 x Bin In 1 x Bin Out | 177463  |
| | – | Ratio (frequency-NPN) | 1 x PWM 2 x PTM | 4...20 mA 0...10 V | 24 V DC | 4...20 mA 0...10 V | 4...20 mA 0...10 V | 1 x Bin In 1 x Bin Out | 208048  |
|  | – | Flow rate (frequency-NPN) | 1 x PWM 2 x PTM | 4...20 mA 0...10 V | 24 V DC | 4...20 mA 0...10 V | 4...20 mA 0...10 V | 1 x Bin In 1 x Bin Out | 177454  |
| | – | Temperature (Pt100) | 1 x PWM 2 x PTM | 4...20 mA 0...10 V | 24 V DC | 4...20 mA 0...10 V | 4...20 mA 0...10 V | 1 x Bin In 1 x Bin Out | 177457  |
| | – | All sensors with standard signal (4...20 mA / 0...10 V) | 1 x PWM 2 x PTM | 4...20 mA 0...10 V | 24 V DC | 4...20 mA 0...10 V | 4...20 mA 0...10 V | 1 x Bin In 1 x Bin Out | 177462  |
| | – | All sensors with standard signal (4...20 mA / 0...10 V) | – | 4...20 mA 0...10 V | – | 24 V DC | 4...20 mA 0...10 V | – | 1 x Bin In 1 x Bin Out |
|  | – | Flow rate (frequency-NPN) | 1 x PWM 2 x PTM | 4...20 mA 0...10 V | 24 V DC | 4...20 mA 0...10 V | 4...20 mA 0...10 V | 1 x Bin In 1 x Bin Out | 177091  |
| | – | Temperature (Pt100) | 1 x PWM 2 x PTM | 4...20 mA 0...10 V | 24 V DC | 4...20 mA 0...10 V | 4...20 mA 0...10 V | 1 x Bin In 1 x Bin Out | 177456  |
| | – | All sensors with standard signal (4...20 mA / 0...10 V) | 1 x PWM 2 x PTM | 4...20 mA 0...10 V | 24 V DC | 4...20 mA 0...10 V | 4...20 mA 0...10 V | 1 x Bin In 1 x Bin Out | 177460  |

1.) Either PWM/PTM or 4...20 mA/0...10 V selectable as PI-control output. If 4...20 mA/0...10 V selected as PI-output, the process value isn't available.

| Mounting disposition | Sensor input | Controller outputs | Setpoint setting | Process value output | Binary In/Out | Article no. |
|---|---|---|---|---|---|--|
| | External | | | | | |
| |  |  |  |  |  | |
| Proportional valve  | Temperature (Pt100) | 1 x PWM | 4...20 mA 0...10 V | 4...20 mA 0...10 V | 1 x Bin In 1 x Bin Out | 204642  |
| | Flow rate (frequency- NPN) | 1 x PWM | 4...20 mA 0...10 V | 4...20 mA 0...10 V | 1 x Bin In 1 x Bin Out | 204639  |
| | All sensors with standard signal (4...20 mA / 0...10 V) | 1 x PWM | 4...20 mA 0...10 V | 4...20 mA 0...10 V | 1 x Bin In 1 x Bin Out | 186289  |















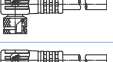



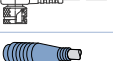







| Mounting disposition | Sensor input | Controller outputs ^{1.)} | Setpoint setting | Process value output | Binary In/Out | Article no. |
|--|---|--|-----------------------|--------------------------------------|---------------------------|--|
| | External | | | | | |
| Panel  | 2 x frequency (NPN/PNP) 1 x 4...20 mA / 0...10 V 1 x Pt100 Ratio control | 1 x PWM 2 x PTM 1 x 4...20 mA/0...10 V | 4...20 mA 0...10 V | 4...20 mA ^{1.)} 0...10 V | 1 x Bin In 2 x Bin Out | 210206  |

1.) Either PWM/PTM or 4...20 mA/0...10 V selectable as PI-control output. If 4...20 mA/0...10 V selected as PI-output, the process value isn't available.

6.4. Ordering chart accessories

Note:



Accessories have to be ordered separately.

| Description | Article no. |
|---|--|
|  Positioning system 8810 for pneumatic actuators with rail-mount adaptor | 204458  |
|  4 pin M8 female right angle connector with self-locking threaded joint and 2 m moulded cable (valve output) | 918718  |
|  4 pin M8 female right angle connector with self-locking threaded joint and 5 m moulded cable (valve output) | 919412  |
|  3 pin M8 female right angle connector with self-locking threaded joint and 2 m moulded cable (sensor input) | 918717  |
|  3 pin M8 female right angle connector with self-locking threaded joint and 5 m moulded cable (sensor input) | 919410  |
|  4 pin M8 female connector, straight with snap-on connection and 2 m moulded cable (valve output) | 919060  |
|  3 pin M8 female connector, straight with snap-on connection and 2 m moulded cable (sensor input) | 918039  |
|  8 pin M12 female connector, straight with screw connection and 2 m moulded cable (PUR) (Power supply) | 919061  |
|  8 pin M12 female connector, straight with screw connection, to assemble (Power supply) | 918998  |
|  2 pin female connector, straight with 3 m cable (for connection to Positioning system 8810) | 133486  |
|  2 pin female connector, straight with 5 m cable (for connection to Positioning system 8810) | 167494  |
|  2 pin female connector, straight with 0.3 m wire (for connection to Positioning system 8810) | 644068  |
|  2 pin female connector, straight with 0.6 m wire (for connection to Positioning system 8810) | 162144  |

6.5. Ordering chart spare parts

Note:

Spare parts have to be ordered separately.

| Description | | Article no. |
|---|-------------------------------------|--|
|  | Wall-mounting adaptor | 427098  |
|  | Rail-mounting adaptor | 655980  |
|  | Mounting brackets (set of 4 pieces) | 560225  |

Bürkert – Close to You

For up-to-date addresses
please visit us at
www.burkert.com

DTS 1000089169 EN Version: W Status: RL (released | freigegeben | validé) printed: 14.09.2020

