









multiCELL - Multi-channel and multi-function transmitter/controller

- Compatible with most common flow, pH/ORP, chlorine and conductivity sensors
- Simple, intuitive user interface with a large adjustable backlit graphics display (4 user defined views)
- Hardware extension possibilities (up to 6 free slots)
- Industrial Ethernet (Modbus TCP, PROFINET or EtherNet/IP) option available
- Functionality extendable by software options

Product variants described in the data sheet may differ from the product presentation and description.

Can be combined with

	Type 8200 ▶ Armatures for analytical sensors
	Type 8201 ▶ pH measuring system for hygienic applications
	Type 8203 ▶ pH- and ORP-probes
	Type 8221 ▶ Conductivity sensor for hygienic applications
	Type 8030 ▶ Inline flowmeter for continuous measurements
	Type 8232 ▶ Chlorine sensor

Type description

The 8619 multichannel and multifunction transmitter/controller, available in two housing variants for panel or wall mounting, is a microprocessor transmitter/controller for connection of sensors which deliver raw signals for pH, ORP, conductivity and flow via pulses or sensors (like pressure, level, chlorine...) which deliver analogue signals (0...20 mA, 4...20 mA, 0...2 V, 0...5 V, 0...10 V).

Type 8619 is the ideal device for measurement and control, as well as dosing processes e.g. in applications of water treatment plants (like boiler, cooling tower or reverse osmosis systems) and food and pharma plants. Modularity in hardware and software offers high flexibility for adjusting it to the applications resulting in a very good price to functionality relation. Sophisticated electronics and state of the art control algorithms ensure that optimum process control is maintained at all times with minimal operator intervention while achieving the highest quality.

Thanks to full support of the Modbus TCP, PROFINET (Conformance Class B) or EtherNet/IP, the 8619 can be integrated into most Industrial Ethernet environments. Therefore all important process values like measurement data, process diagnostics or device status can be easily integrated into the automation system.

Table of contents

1. General technical data	4
1.1. About the device.....	4
1.2. All versions.....	4
1.3. Transmitter/controller multiCELL	6
1.4. Transmitter/controller multiCELL WM DC.....	7
1.5. Transmitter/controller multiCELL WM AC	8
2. Product versions	9
2.1. Input module.....	9
2.2. Output module.....	10
2.3. Inputs module for pH/ORP and Pt100/Pt1000 sensors	10
2.4. Inputs module for conductivity and Pt100/Pt1000 sensors	11
2.5. Ethernet module (industrial communication)	11
3. Approvals	13
3.1. Certification.....	13
4. Materials	13
4.1. Material specifications	13
Panel-mounted	13
Wall-mounted	14
5. Dimensions	15
5.1. Panel-mounted	15
5.2. Wall-mounted	16
6. Performance specifications	17
6.1. Current temperature diagram.....	17
7. Product operation	17
7.1. Principle of operation.....	17
7.2. Functional overview	18
Process diagram	18
List of available functions	18
Concentration table multiCELL.....	20
8. Product design and assembly	20
8.1. Product features	20
Panel-mounted	20
Wall-mounted	21
9. Networking and combination with other Bürkert products	22
10. Ordering information	23
10.1. Bürkert eShop – Easy ordering and quick delivery.....	23
10.2. Recommendation regarding product selection	23
10.3. Bürkert product filter.....	23
10.4. Ordering chart.....	24
Ordering chart for panel-mounted version, 12...36 V DC	24
Ordering chart for wall-mounted version, 12...36 V DC	25

Ordering chart for wall-mounted version, 110...240 V AC	26
Ordering chart for additional software functions for Type 8619	27
10.5. Ordering chart accessories.....	27

1. General technical data

1.1. About the device

The Type 8619 is a multifunction device intended to display, record, transmit, exchange and regulate various physical parameters. It is available in two housing variant:

- The panel-mounted version with a DC operating voltage, called multiCELL, is in a standardized ¼ DIN housing for 92x92 mm cutout to be mounted in the door of the electrical enclosure or cabinet and attached using 4 fastening elements.



- The wall-mounted version with a DC or an AC operating voltage, respectively called multiCELL WM DC or multiCELL WM AC is in a housing to be mounted on a wall with help of mounting plate.



1.2. All versions

The following data applies to both housing variants.

Product properties

Material

Detailed information can be found in chapter [“4.1. Material specifications” on page 13.](#)

Protective blank PA66 (for a slot without connection terminal)

Display PC

Front panel coating and keys Silicone

Seal Silicone

Ground screws, spring washer Stainless steel 316 (A4)

Terminal support plate Stainless steel 304

Terminal blocks PBT, contact in gold-plated copper alloy

- Port for an RJ45 connector
- Housing: copper alloy and thermoplastic
 - Contacts: gold-plated

Dimensions Detailed information can be found in chapter [“5. Dimensions” on page 15.](#)

- Display
- LC graphic display
 - Light blue back-lighted
 - 128 x 168 pixels resolution
 - German, English, French languages

- Keypad
- 4 soft keys [F1] [F2] [F3] [F4] for dynamic functions
 - 1 central navigation key with [↑] [↓] [→] [←] assignments

Data logger Up to 16 values

Sensor monitor Direct display and verification of measured sensor values

Clock Real-time clock with date

Module slots 6

Memory card SD (Secure Digital) or SDHC (Secure Digital High Capacity), max. 8 GB capacity

Note:

We recommend to use the 8 GB SDHC memory card available at Bürkert (see chapter [“10.5. Ordering chart accessories” on page 27](#)) because it has been tested with and validated for the 8619 Transmitter/Controller. Another memory card may not operate correctly. With 8 values recorded every 10 sec., the 8 GB card allows continuous recording over 500 days.

Performance data4...20 mA output resolution 6 μ A**Electrical data**

Inputs

- Digital DI1, DI2
- Voltage: 0...36 V DC^{1.)}
- Input impedance 3 k Ω
- Switching threshold:
 - V_{on} = 5...36 V DC^{1.)}
 - V_{off} < 2 V DC
- Frequency: 0.5...2500 Hz
- Galvanic insulation
- Protected against reversed polarity of DC and voltage spikes

Outputs

- Analogue AO1, AO2
 - 4...20 mA
 - Can be wired as sourcing or sinking
 - Galvanic insulation
 - Protected against reversed polarity of DC
 - Max. loop impedance: 1100 Ω at 36 V DC^{1.)}, 860 Ω at 30 V DC, 610 Ω at 24 V DC, 100 Ω at 12 V DC
- Digital DO1, DO2
 - Transistor
 - Can be wired as PNP or NPN
 - Galvanic insulation
 - Protected against short circuit
 - Max. 36 V DC^{1.)}
 - Max. 700 mA if 1 DO per module is activated
 - Max. 1 A if the 2 DO's per module are activated
 - Max. 4 A for an Ethernet version if the device has 4 output modules
 - Operating modes: On/Off, Hysteresis, Window, fast PWM, PWM, PFM, Pulse
 - Frequency: max. 2000 Hz

Connection & communication

Electrical connection Terminal blocks, RJ45 connector (hybrid for panel-mounted version)

Approvals and certificates**Directives**

CE directives The applied standards, which verify conformity with the EU Directives, can be found on the EU Type Examination Certificate and/or the EU Declaration of conformity (if applicable)

Certifications

- UL-Recognized for US and Canada
- PROFINET
- EtherNet/IP

Environment and installation

Ambient temperature

Storage:

- -20...+70 °C (-4...+140 °F)
- Limited to -10...+70 °C (+14...+140 °F) if memory card is inserted

Relative air humidity

< 85%, without condensation

Height above sea level

Max. 2000 m

Operating conditions

Continuous

Equipment mobility

Fixed device

Application range

Indoor and outdoor (protect the device against electromagnetic interference, ultraviolet rays and against the effects of climatic conditions)

1.) If the device is mounted in a humid environment or outside, then the maximum voltage allowed is 35 V DC instead of 36 V DC.

1.3. Transmitter/controller multiCELL

Note:

If the device is mounted in a humid environment or outside, then the maximum voltage allowed is **35 V DC** instead of 36 V DC.

Product properties

Material

Detailed information can be found in chapter **"Panel-mounted"** on page 13.

Front panel	PC
Housing	PPO
Fastening element	PPO

Electrical data

Operating voltage	<ul style="list-style-type: none"> Marked "SUPPLY" on terminal block 12...36 V DC \pm 10%, max. 2 A, filtered and regulated Connection to main supply: permanent (through external SELV (Safety Extra Low Voltage) and LPS (Limited Power Source) power supply
Power source (not supplied)	Limited power source according to UL/EN 60950-1 standards or limited energy circuit according to UL/EN 61010-1 §9.4
Power consumption	<ul style="list-style-type: none"> Of the device without additional modules and outputs not connected Max. 1.5 VA
Power distribution	<ul style="list-style-type: none"> Marked "PWR OUT" on terminal block 12...36 V DC, max. 1.8 A Protected against polarity reversals of DC
Voltage supply cable	<ul style="list-style-type: none"> Cable with maximum operating temperature greater than +90 °C (+194 °F) Cross section of <ul style="list-style-type: none"> Earth connection conductor: 0.75...1.5 mm² Rigid H05(07) V-U: 0.2...1.5 mm², stripped over 7 mm, shielded cable Flexible H05(07) V-K: 0.2...1.5 mm², stripped over 7 mm, shielded cable Conductor with non-insulated lug: 0.2...1.5 mm², stripped over 7 mm, shielded cable Conductor with an insulated lug: 0.2...0.75 mm², stripped over 7 mm, shielded cable

Approvals and certificates

Standards

Degree of protection	<ul style="list-style-type: none"> IP65^{1.)} according to IEC/EN 60529 (panel-mounted, cabinet closed) IP20^{1.)} according to IEC/EN 60529 (panel-mounted, inside the cabinet) NEMA250 4X (panel-mounted, in front of the closed cabinet)
----------------------	--

Environment and installation

Ambient temperature	Operation (with/without memory card ^{2.)}): <ul style="list-style-type: none"> Only with main module: -10...+70 °C (+14...+158 °F) With min. one additional module: -10...+60 °C (+14...+140 °F)
Installation category	Category I according to UL/EN 61010-1
Pollution degree	Degree 2 according to UL/EN 61010-1

1.) Not evaluated by UL

2.) If a different memory card is used, observe the operating temperatures specified by its manufacturer.

1.4. Transmitter/controller multiCELL WM DC

Note:

If the device is mounted in a humid environment or outside, then the maximum voltage allowed is **35 V DC** instead of 36 V DC.

Product properties

Material

Detailed information can be found in chapter [“Wall-mounted” on page 14.](#)

Housing	PA66
Fastening plate	PA66
Cable gland	PA66
Protecting cover (for display)	PA66
Protecting cap (free terminal place)	PA66
Stiffener hinge	PA66
Cover screws	PVC

Electrical data

Operating voltage	<ul style="list-style-type: none"> Marked “12...36 V DC” on terminal block 12...36 V DC $\pm 10\%$, max. 2 A, filtered and regulated Connection to main supply: permanent (through external SELV (Safety Extra Low Voltage) and LPS (Limited Power Source) power supply)
Power source (not supplied)	Limited power source according to UL/EN 60950-1 standards or limited energy circuit according to UL/EN 61010-1 §9.4
Power consumption	<ul style="list-style-type: none"> Of the device without additional modules and outputs not connected Max. 2 VA
Power distribution	<ul style="list-style-type: none"> Marked “POWER OUT” on terminal block 12...36 V DC, max. 1.8 A Protected against polarity reversals of DC
Voltage supply cable	<ul style="list-style-type: none"> Cable with maximum operating temperature greater than +90 °C (+ 194 °F) External diameter: 6...12 mm (4 mm if using a multiple entry seal) Cross section of <ul style="list-style-type: none"> Earth connection conductor: min. 1.5 mm² Rigid H05(07) V-U: 0.2...1.5 mm², stripped over 7 mm, shielded cable Flexible H05(07) V-K: 0.2...1.5 mm², stripped over 7 mm, shielded cable Conductor with non-insulated lug: 0.2...1.5 mm², stripped over 7 mm, shielded cable Conductor with an insulated lug: 0.2...0.75 mm², stripped over 7 mm, shielded cable

Approvals and certificates

Standards

Degree of protection ^{1.)} according to IEC/EN 60529	IP65, IP67, if the following conditions are met: <ul style="list-style-type: none"> Glands body tightened with a tightening torque of 5.5 Nm $\pm 20\%$, made at factory Glands blanked off or wired Gland nuts tightened with a tightening torque of 4.5 Nm $\pm 20\%$ Housing closed and 4 screws of cover cross tightened with a tightening torque of 1.4 Nm $\pm 20\%$
---	---

Environment and installation

Ambient temperature	Operation (with/without memory card ^{2.)}): <ul style="list-style-type: none"> Only with main module: -10...+75 °C (+ 14...+167 °F) With min. one additional module: -10...+60 °C (+ 14...+ 140 °F)
Installation category	Category I according to UL/EN 61010-1
Pollution degree	Degree 2 according to UL/EN 61010-1

1.) Not evaluated by UL

2.) If a different memory card is used, observe the operating temperatures specified by its manufacturer.

1.5. Transmitter/controller multiCELL WM AC

Product properties

Material

Detailed information can be found in chapter [“Wall-mounted”](#) on page 14.

Housing	PA66
Fastening plate	PA66
Cable gland	PA66
Protecting cover (for display)	PA66
Protecting cap (free terminal place)	PA66
Stiffener hinge	PA66
Cover screws	PVC
Protective cap of AC terminal block	Stainless steel 304

Electrical data

Operating voltage	<ul style="list-style-type: none"> Marked “110-240 V~ / 50/60 Hz” on terminal block 110...240 V AC, 50...60 Hz, max. 550 mA Integrated protection: 3.15 A time delay fuse
Power consumption	<ul style="list-style-type: none"> Of the device without additional modules and outputs not connected Max. 2 VA
Power distribution	<ul style="list-style-type: none"> Marked “POWER OUT” on terminal block 24 V DC $\pm 2\%$, filtered and regulated, max. 1.3 A SELV (safety extra low voltage) circuit with a non dangerous energy level Protected against polarity reversals of DC The allowed max. current depends on the ambient temperature: see chapter “6.1. Current temperature diagram” on page 17
Voltage supply cable	<ul style="list-style-type: none"> Cable with maximum operating temperature greater than +90 °C (+194 °F) External diameter: 6...12 mm (4 mm if using a multiple entry seal) Cross section of <ul style="list-style-type: none"> Earth connection conductor: min. 1.5 mm² Rigid H05(07) V-U: 0.2...1.5 mm², stripped over 7 mm, shielded cable Flexible H05(07) V-K: 0.2...1.5 mm², stripped over 7 mm, shielded cable Conductor with non-insulated lug: 0.2...1.5 mm², stripped over 7 mm, shielded cable Conductor with an insulated lug: 0.2...0.75 mm², stripped over 7 mm, shielded cable

Approvals and certificates

Standards

Degree of protection ^{1.)} according to IEC/EN 60529	<p>IP65, IP67, if the following conditions are met:</p> <ul style="list-style-type: none"> Glands body tightened with a tightening torque of 5.5 Nm $\pm 20\%$, made at factory Glands blanked off or wired Gland nuts tightened with a tightening torque of 4.5 Nm $\pm 20\%$ Housing closed and 4 screws of cover cross tightened with a tightening torque of 1.4 Nm $\pm 20\%$
---	--

Environment and installation

Ambient temperature	<p>Operation (with/without memory card^{2.)}):</p> <ul style="list-style-type: none"> Only with main module: -10...+70 °C (+14...+158 °F) With min. one additional module: -10...+60 °C (+14...+140 °F)
Installation category	Category II according to UL/EN 61010-1
Pollution degree	Degree 3 according to UL/EN 61010-1 if the following conditions are met: housing tightly closed and the 4 screws of the cover are tightened crosswise at a torque of 1.4 Nm $\pm 20\%$

1.) Not evaluated by UL

2.) If a different memory card is used, observe the operating temperatures specified by its manufacturer.

2. Product versions

Five different types of modules are available and can be inserted into any of the 6 slots (preconfigured at the factory).

- Input module:
 - 2 analogue inputs (4...20 mA or 0...20 mA or 0...2 V or 0...5 V or 0...10 V) and
 - 2 digital inputs (static or frequency/pulse)
- Output module:
 - 2 transistor outputs and
 - 2 analogue 4...20 mA outputs
- Inputs module for pH/ORP and Pt100/Pt1000 sensors
- Inputs module for conductivity and Pt100/Pt1000 sensors
- Ethernet module: Modbus TCP, PROFINET Conformance Class B and EtherNet/IP

2.1. Input module

Electrical data	
Power consumption	0.1 VA
Analogue inputs	AI1, AI2 <ul style="list-style-type: none"> • Can be wired as sourcing or sinking • Galvanic insulation • Current <ul style="list-style-type: none"> – Range: 0 or 3.5...22 mA – Max. voltage: 36 V DC¹⁾ – Impedance: 50 Ω – Resolution: 1.5 μA • Voltage <ul style="list-style-type: none"> – Range: 0...2 or 5 or 10 V DC – Max. voltage: 36 V DC¹⁾ – Impedance: 110 kΩ – Resolution: 1 mV • Measuring deviation: ±0.25% of measured value
Digital inputs	DI1, DI2 <ul style="list-style-type: none"> • Galvanic insulation • Voltage: 0...36 V DC¹⁾ • Input impedance: 3 kΩ • Switching threshold: <ul style="list-style-type: none"> – $V_{on} = 5...36 \text{ V DC}^{1)}$ – $V_{off} < 2 \text{ V DC}$ • Frequency: 0.5...2500 Hz • Protected against reversed polarity of DC and voltage spikes

2.2. Output module

Electrical data	
Power consumption	0.1 VA
Analogue outputs	AO1, AO2 <ul style="list-style-type: none"> • Can be wired as sourcing or sinking • Galvanic insulation • 4...20 mA • Protected against reversed polarity of DC • Max. loop impedance: 1100 Ω at 36 V DC¹⁾, 610 Ω at 24 V DC, 100 Ω at 12 V DC • Resolution: 6 μA • 4...20 mA output uncertainty: ±0.5 % of the transmitted value
Digital outputs	DO1, DO2 <ul style="list-style-type: none"> • Transistor • Can be wired as PNP or NPN • Galvanic insulation • Max. 36 V DC¹⁾ • Max. 700 mA if 1 DO per module is activated • Max. 1 A if the 2 DO's per module are activated • Max. 4 A for an Ethernet version if the device has 4 output modules • Protected against short circuit • Operating modes: On/Off, Hysteresis, Window, PWM, PFM • Frequency: max. 2000 Hz

2.3. Inputs module for pH/ORP and Pt100/Pt1000 sensors

Electrical data	
Power consumption	0.1 VA
pH/ORP input	Simultaneous pH and ORP measurement with input for electrochemical pH/ORP
Temperature input	Pt100/Pt1000, 2 or 3 wires
pH measurement	<ul style="list-style-type: none"> • Measuring range: -2.0...+16 pH or -600...+600 mV • Resolution: 0.01 pH or 0.1 mV • Measurement deviation: ±0.02 pH or 1 mV + error of the pH probe¹⁾ • Probe type: electrochemical
ORP measurement	<ul style="list-style-type: none"> • Measuring range: -2000...+2000 mV • Resolution: 0.1 mV • Measurement deviation: ±1 mV + error of the ORP probe¹⁾ • Probe type: electrochemical
Temperature measurement	<ul style="list-style-type: none"> • Measuring range: -25...+130 °C (-20...+266 °F) • Resolution: 0.1 °C (0.18 °F) • Measurement deviation: ±1 °C (1.8 °F) + error of the temperature probe¹⁾ • Probe type: Pt100/Pt1000, 2 or 3 wires

1.) See related probe data sheet

2.4. Inputs module for conductivity and Pt100/Pt1000 sensors

Electrical data	
Power consumption	0.25 VA
Resistance measurement	5.0 Ω...1 MΩ (without conductivity probe connected)
Conductivity input	Operation with 2 or 4 pin technology sensors
Temperature input	Pt100/Pt1000, 2 or 3 wires
Conductivity measurement	With connected conductivity probe <ul style="list-style-type: none"> Measuring range: 0 μS/cm...2 S/cm (depending on the conductivity cell) Resolution: 1 nS/cm Measurement deviation: ±0.5 % of measured value + error of the conductivity probe^{1.)}
Resistivity measurement	With connected conductivity probe <ul style="list-style-type: none"> Measuring range: 0.5 Ω·cm...100 MΩ·cm (depending on the conductivity cell) Resolution: 0.1 Ω·cm Measurement deviation: ±0.5 % of measured value + error of the conductivity probe^{1.)}
Temperature measurement	<ul style="list-style-type: none"> Measuring range: -40...+200 °C (-40...+392 °F) Resolution: 0.1 °C (0.18 °F) Measurement deviation: ±1 °C (1.8 °F) + error of the temperature probe^{1.)} Probe type: Pt100/Pt1000, 2 or 3 wires

1.) See related probe data sheet

2.5. Ethernet module (industrial communication)

Electrical data	
Power consumption	2.2 VA
Connection cable	<ul style="list-style-type: none"> Shielded cable: FTP minimum required Minimum category: 5e / CAT-5 Length: max. 100 m
Connection & communication	
Electrical connection	2 ports for an RJ45 connector (not provided) <p>Note: to make sure the door of a wall-mounted Ethernet version can be fully closed, use RJ45 male connectors with maximum dimensions of 45 mm, including the bend radius of the Ethernet cable.</p>
Industrial Communication	
Supported network protocols	<ul style="list-style-type: none"> Modbus TCP PROFINET EtherNet/IP
LEDs	<ul style="list-style-type: none"> 2 Link/Act LEDs (yellow) 2 Link LEDs (green)
Modbus TCP protocol	
Protocol	Internet protocol, version 4 (IPv4)
Network topology	<ul style="list-style-type: none"> Tree Star Line (open daisy chain)
IP configuration	<ul style="list-style-type: none"> Static IP address BOOTP (Bootstrap Protocol) DHCP (Dynamic Host Configuration Protocol)
Transmission speed	10 or 100 MBit/s

PROFINET protocol

PROFINET IO specification	V2.3
Network topology	<ul style="list-style-type: none"> • Tree • Star • Ring (closed daisy chain) • Line (open daisy chain)
Network management	<ul style="list-style-type: none"> • LLDP (Link Layer Discovery Protocol) • SNMP V1 (Simple Network Management Protocol) • MIB (Management Information Base)
IP configuration	<ul style="list-style-type: none"> • DCP (Discovery and Configuration Protocol) • Manual (Device naming and IP setting)
Transmission speed	100 MBit/s full duplex
Maximum supported conformance class	CC-B
Media Redundancy (for ring topology)	MRP client is supported
GSDml file	See “Device Description Files” on the website in the Software chapter Type 8619 ▶

EtherNet/IP protocol

Protocol	Internet protocol, version 4 (IPv4)
Network topology	<ul style="list-style-type: none"> • Tree • Star • Ring (closed daisy chain) • Line (open daisy chain)
IP configuration	<ul style="list-style-type: none"> • Static IP address • BOOTP (Bootstrap Protocol) • DHCP (Dynamic Host Configuration Protocol)
Transmission speed	10 or 100 MBit/s
Duplex modes	Half duplex, full duplex, auto-negotiation
MDI modes (Medium Dependant Interface)	Auto-MDIX
Predefined standard objects	<ul style="list-style-type: none"> • Identity • Message Router • Assembly • Connection Manager • DLR • QoS • TCP/IP Interface
Device specified objects	<ul style="list-style-type: none"> • EtherNet Link object • I/O main board M0 • Functions • Extension modules • Ethernet module
EDS file	See “Device Description Files” on the website in the Software chapter Type 8619 ▶

3. Approvals

Note:

- The certification/certificate listed below must be stated when making enquiries. This is the only way to ensure that the product complies with all required specifications.
- Not all available devices can be supplied with the certification/certificate below.

3.1. Certification

Certificate	Description
 Measuring Equipment E237737	UL-Listed for USA and Canada Products are UL-listed products and comply also with the following standards: <ul style="list-style-type: none"> • UL 61010-1 • CAN/CSA-C22.2 No.61010-1 Certificate number: 2017-10-27-E237737
	PROFINET Certificate number: Z11949
EtherNet/IP	EtherNet/IP Document number: 11654

4. Materials

4.1. Material specifications

Panel-mounted

Note:

Shown with Ethernet version

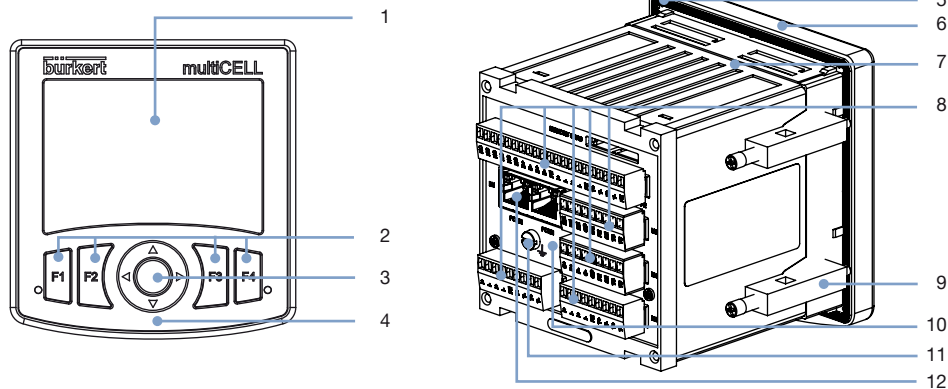

No.	Description	Material
1	Display	PC
2	Dynamic keys	Silicone
3	Navigation key	Silicone
4	Front panel coating	Silicone
5	Seal	Silicone
6	Front panel	PC
7	Housing	PPO
8	Terminal blocks	PBT, gold-plated copper alloy contact
9	Fastening element	PPO
10	Support plate for terminals	Stainless steel 304
11	Ground screw	Stainless steel 316 (A4)
12	Port for an RJ45 connector	Gold-plated copper alloy contact, thermoplastic

DTS 1000130448 EN Version: S Status: RL (released | freigegeben | validé) printed: 01.02.2022

Wall-mounted

Note:

Shown with Ethernet version

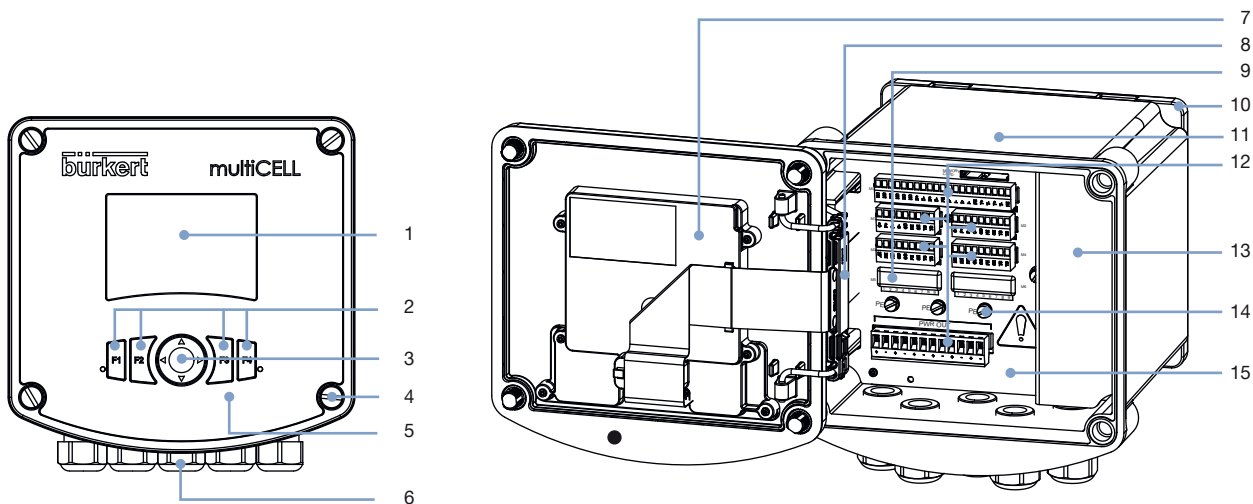

No.	Description	Material
1	Display	PC
2	Dynamic keys	Silicone
3	Navigation key	Silicone
4	Cover screws	PVC
5	Front panel coating	Silicone
6	Cable glands	PA66
7	Protecting cover (for display)	PA66
8	Stiffener hinge	PA66
9	Protecting cap (free terminal place)	PA66
10	Fastening plate	PA66
11	Housing	PA66
12	Terminal blocks	PBT, gold-plated copper alloy contact
13	Protective cap of AC terminal block	Stainless steel 304
14	Ground screw	Stainless steel 316 (A4)
15	Support plate for terminals	Stainless steel 304

5. Dimensions

5.1. Panel-mounted

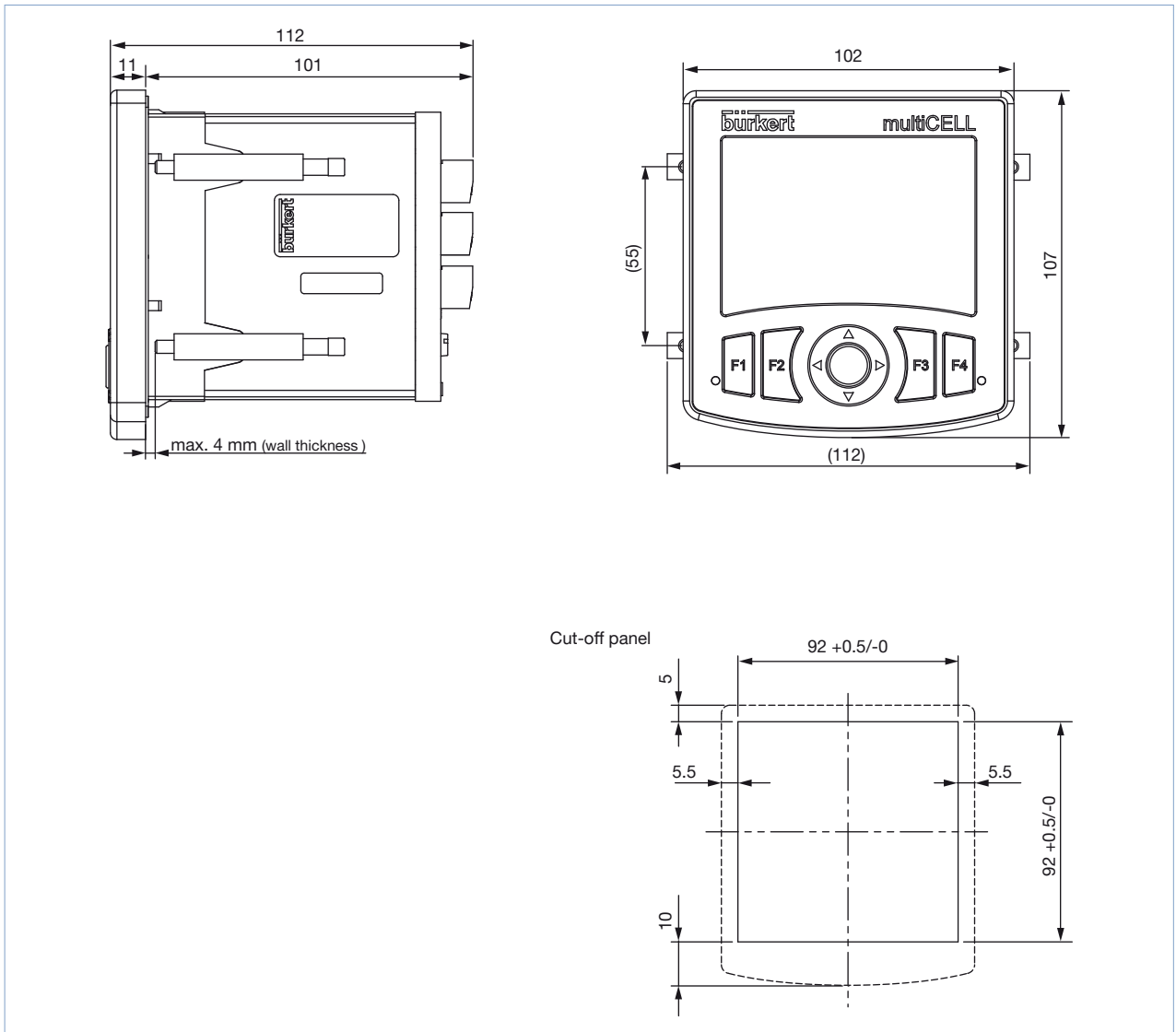

5.2. Wall-mounted

Note:

The housing variant for wall mounting can also be installed on a pipe using a mounting set (has to be ordered separately, see chapter "10.5. Ordering chart accessories" on page 27).

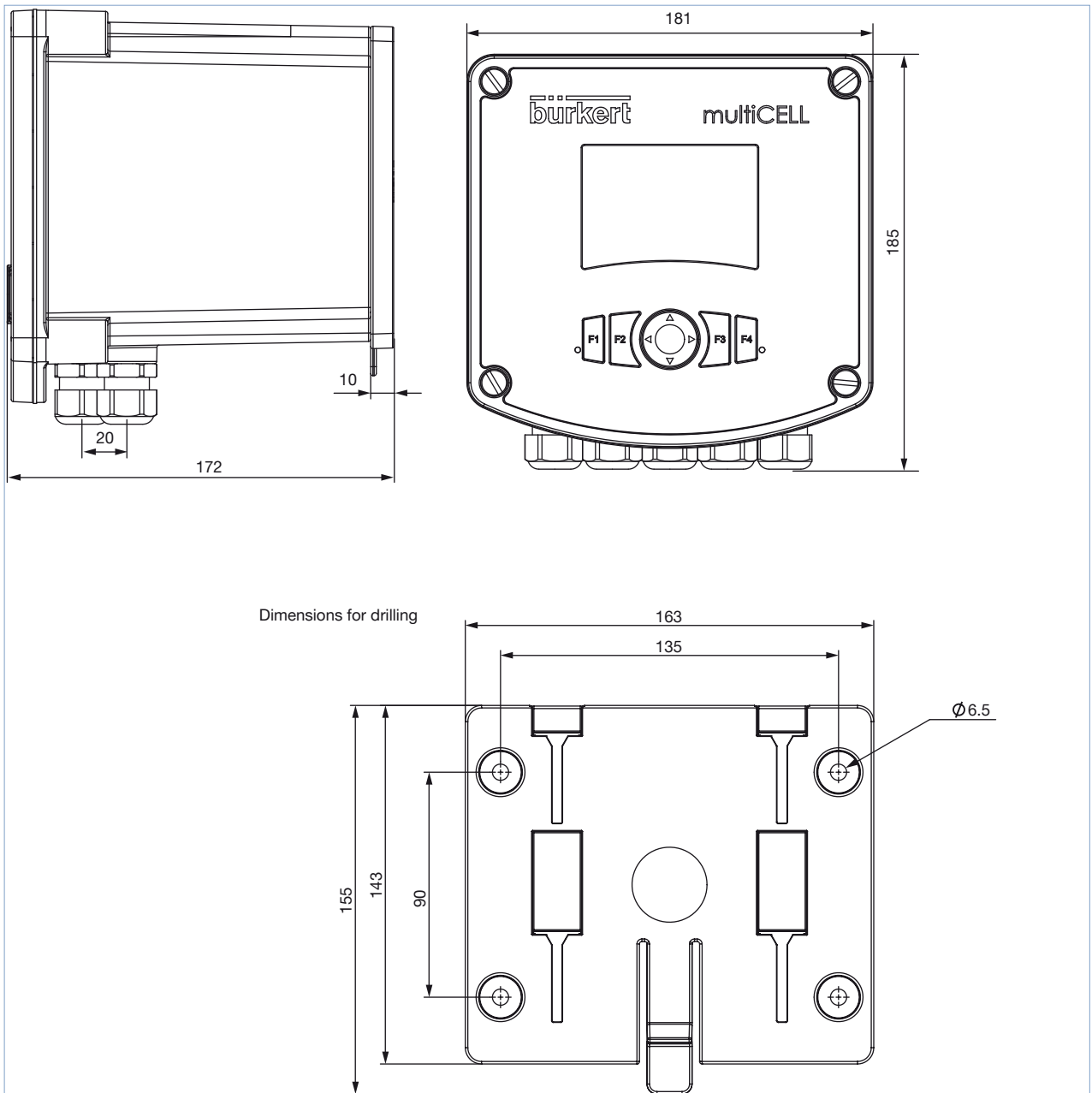

DTS 1000130448 EN Version: S Status: RL (released | freigegeben | validé) printed: 01.02.2022

6. Performance specifications

6.1. Current temperature diagram

Note:

Max. allowed current in dependence of the ambient temperature (for wall-mounted version, 110...240 V AC)

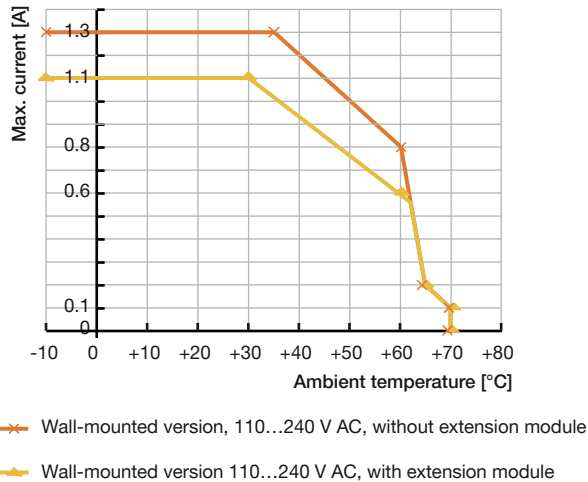

7. Product operation

7.1. Principle of operation

Thanks to its modular internal structure, the transmitter/controller is able to manage, in parallel, different types of sensors and selectively perform operations on the measured values. Multiple tasks can be performed in parallel; from a simple measurement, to a standard output signal, to the assignment of mathematical formulas for selectable values for controlling and dosing. The signal and function modules can be easily connected to each other by configuration. Thanks to individual parameterization, all functions can be adapted to the actual process conditions.

The basic unit is either a panel-mounted version or a wall-mounted version. It has analogue and digital outputs, digital inputs and its front panel has a backlit graphic display. Depending on the application, up to 6 slots are available in which pH/Redox, conductivity, analog and digital output modules, additional analog and digital input boards, and industrial Ethernet modules can be installed. There is no need for a separate 4...20 mA transmitter: the pH, conductivity modules accept raw signals from sensors.

Though highly functional the multiCELL can be operated easily and intuitively. The base for this is the large graphical display and the dynamically assigned function keys. Clearly arranged menu and module structures allow for easy configuration and setup of parameters and offer a high transparency for the functions in use. Four user views can be configured. This allows the user to design a view himself displaying a value arrangement which he likes to see simultaneously and this can be available 4 times and independent from each other.

For data collection and storage e.g. of measurement values there is an optional data logger available which uses the memory card if inserted in the card slot. Uploading and restoring the complete database of the complete 8619, including the special parameter settings of the application and the updating firmware via the memory card is available as standard.

Fully integration into the automation system can be realized with the optional available Industrial Ethernet Module. The protocols Modbus TCP and PROFINET Conformance Class B and EtherNet/IP are fully supported. Thanks to generic configuration files, routing within the PLC can be easily done.

7.2. Functional overview

Process diagram

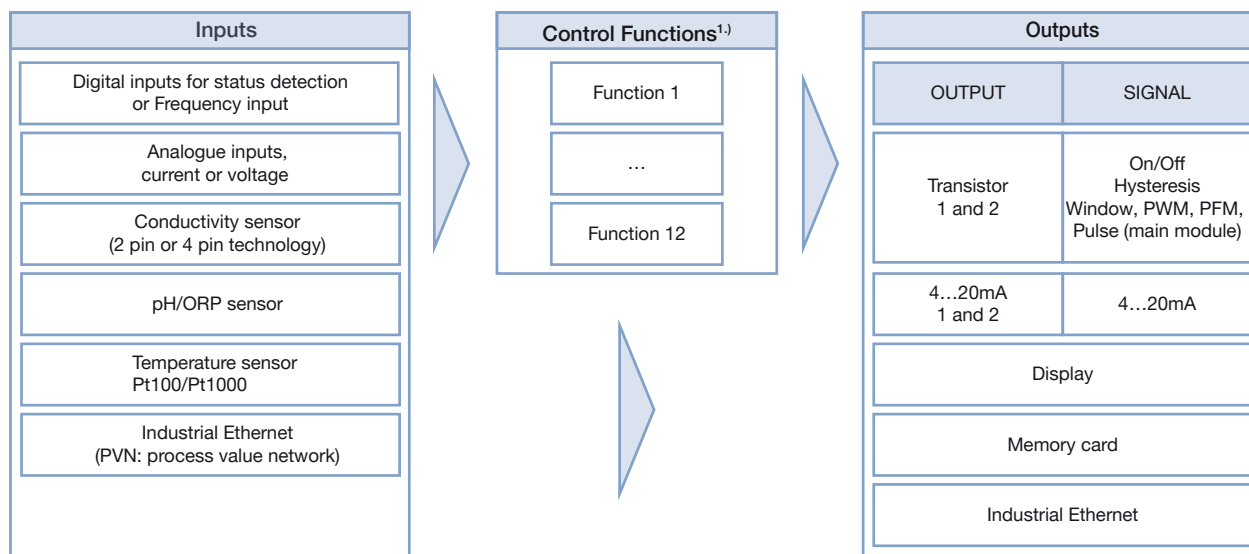

1.) The 12 functions can be activated simultaneously and independently, and up to 6 PID functions can be set; if this option is selected.

List of available functions

The transmitter/controller allows each input to be associated with a function (such as dosing, for example) that can be fully configured by the user. Depending on the model chosen, the following functions are offered as standard or as options.

Functions	Availability	Formula	Example for usage
Arithmetic	Basic for all models	$A + B, A - B, A * B, A / B$	Arithmetic operation (addition, subtraction, multiplication and division) between 2 values. For addition and subtraction, the 2 values must have the same units, but for multiplication and division not necessarily. A and B can be <ul style="list-style-type: none"> • Constants • Measured physical parameters • Results of other active configured functions • The previous result of the same function • Values sent by a PLC (PVN). The multiplication function is available from Software version B.00.01
PASS	Basic for all models	$A / B [\%]$	A and B must have the same units and can be <ul style="list-style-type: none"> • Constants • Measured physical parameters • Results of other active configured functions • The previous result of the same function • Values sent by a PLC (PVN). Calculates a flow ratio between 2 values, e.g: reverse osmosis.
REJECT	Basic for all models	$(1 - A / B) [\%]$	A and B must have the same units and can be <ul style="list-style-type: none"> • Constants • Measured physical parameters • Results of other active configured functions • The previous result of the same function • Values sent by a PLC (PVN). Calculates a reject ratio between 2 values, e.g: reverse osmosis

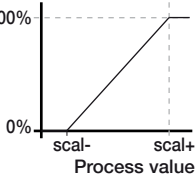
Functions	Availability	Formula	Example for usage
DEVIAT	Basic for all models	$(A/B - 1)[\%]$	Calculates a deviation ratio between 2 values.
MATH	As option	Permits to enter an equation which respects the following rules: <ul style="list-style-type: none"> • Up to 125 characters; • Up to 5 process values (A, B, C, D & E) • With possible operators: $() ! \pm ^ \times \div \% + - < > \leq \geq$ 	A, B, C, D, E can be <ul style="list-style-type: none"> • Constants • Measured physical parameters • Results of other active configured functions • The previous result of the same function • Values sent by a PLC (PVN) e.g: $(A*B)+(C*D)-E$
PROP	Basic for all models		Calculates an output in proportion to a scaled input
ON/OFF	Basic for all models	On/Off control loop	For any type of input
Flow rate measurement	As base for model article no. 560205, 560213, 565984, 565985, 565986, 565987 for others as option	–	Allows both digital inputs to be used as frequency inputs for flow measurement (in standard for base unit) or coexistent with analytical modules (in option for others devices)
PID control	As option	Continuous control loop	For any type of input and with internal or external setpoint
Time dosing	As option	–	e.g. for cooling tower application. Dosing of 1 or 2 biocides in the circuits, at fixed time intervals or by defining dosing during one week, with 2 dosings per day. Can be connected to an ON/OFF conductivity function for pre-purge.
Special Chemical batch (Volume dosing)	As option	–	Specifically for cooling tower application. A defined volume of water is counted, then an actuator is energized during a defined time to add a chemical and finally reset the water volume counter.
Concentration	As option	–	The concentration curves of NaCl, H ₂ SO ₄ , HNO ₃ , NaOH, HCl are implemented for use in complete concentration range and not only in low concentration.
Data logging on memory card	As option	–	Up to 16 values can be stored at a defined time interval.

Concentration table multiCELL

If multiCELL 8619 is equipped with a conductivity module, multiCELL is able to calculate the concentration depending on the measured conductivity and temperature. Therefore concentration tables for binary mixtures of (five) different substances and water are available. Determine the best suited concentration range (out of ten ranges) for your application.

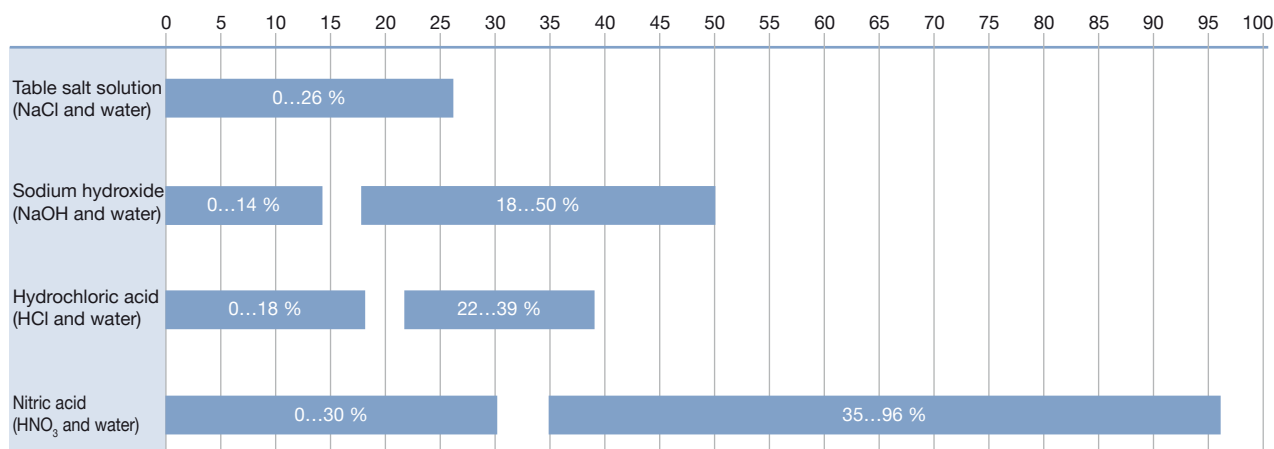

8. Product design and assembly

8.1. Product features

Panel-mounted

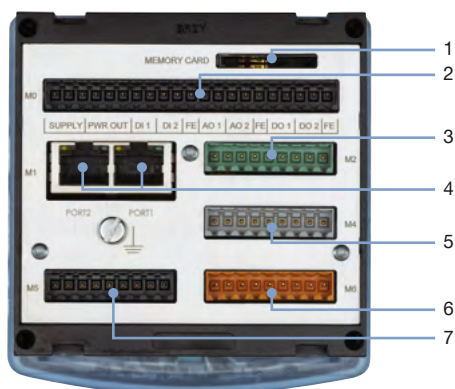

Memory card slot	
1	<ul style="list-style-type: none"> For upload and download of parameter settings Software updates and functional upgrades Simple operation: insert the memory card into the slot on the rear of the device.
Main module slot	
2	Enables: <ul style="list-style-type: none"> Connection to the transmitter/controller power supply To power another device The use of 2 digital inputs (DI), 2 analogue (AO) and 2 digital (DO) outputs
Additional module slots (up to 6) to choose among	
3	Module for conductivity sensor and/or temperature sensor (green connector)
4	Module for Industrial Ethernet (2 RJ45 connectors) Ethernet module takes two slots and is available from Software version B.00.01
5	Module for pH/ORP sensor and/or temperature sensor (light grey connector)
6	Module for 2 analogue and 2 digital inputs (orange connector)
7	Module for 2 analogue and 2 digital outputs (black connector)

DTS 1000130448 EN Version: S Status: RL (released | freigegeben | valide) printed: 01.02.2022

Wall-mounted

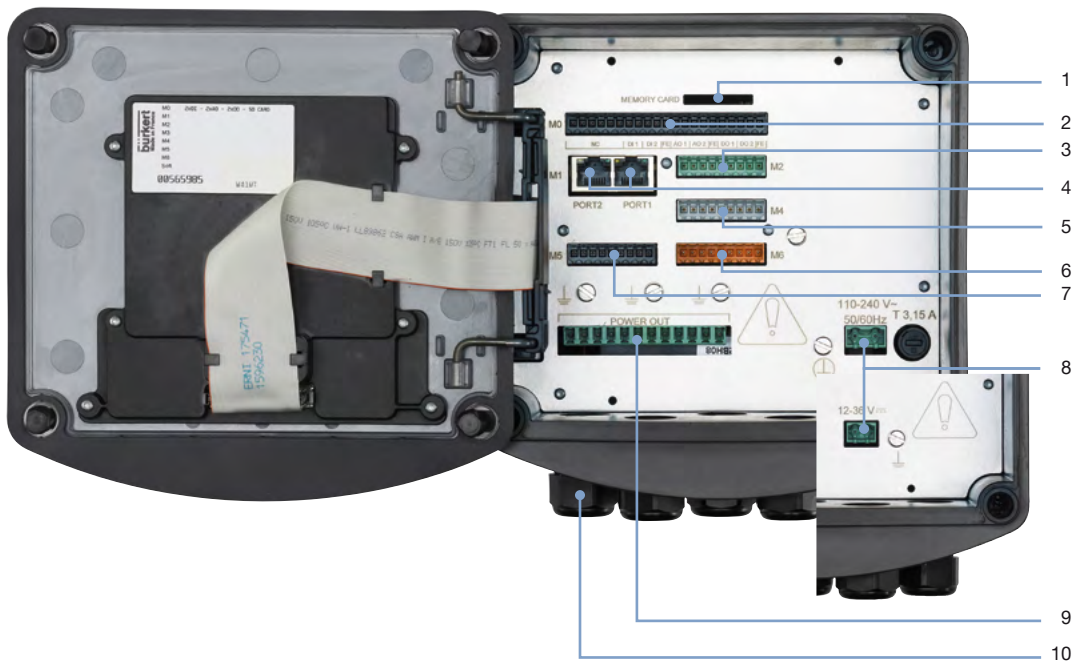

Memory card slot	
1	<ul style="list-style-type: none"> For upload and download of parameter settings Software updates and functional upgrades Simple operation: insert the memory card into the slot on the rear of the device.
Main module slot	
2	Enables the use of 2 digital inputs (DI), 2 analogue (AO) and 2 digital (DO) outputs
Additional module slots (up to 6) to choose among	
3	Module for conductivity sensor and/or temperature sensor (green connector)
4	Module for Industrial Ethernet (2 RJ45 connectors) Ethernet module takes two slots and is available from Software version B.00.01
5	Module for pH/ORP sensor and/or temperature sensor (light grey connector)
6	Module for 2 analogue and 2 digital inputs (orange connector)
7	Module for 2 analogue and 2 digital outputs (black connector)
Power supply slot	
8	Enables connection to the transmitter/controller power supply (behind the protecting cover for 110...240 V AC version)
Power charges slot	
9	Enables to power another device
Optional M12 connector	
10	For industrial Ethernet

DTS 1000130448 EN Version: S Status: RL (released | freigegeben | validé) printed: 01.02.2022

9. Networking and combination with other Bürkert products

Example:



Type 8619

Flow		Input signal			Pressure	Output signal	
Type 8031 ▶ Flowmeter for low flow rates	Type 8041 ▶ Magflowmeter	Type 8200 ▶ Probes holder with	Type 8220 ▶ Resistive conductivity sensor	Type 8232 ▶ Chlorine sensor	Type 8316 ▶ Pressure meter	Type 2030 ▶ Diaphragm valve with pilot valve	Type 8802 ▶ Diaphragm control valve with TopControl
Type 8030 ▶ Inline flowmeter with paddle wheel		Type 8203 ▶ pH or ORP probe and temperature sensor	Type 8221 ▶ Hygienic conductivity sensor				
Type 8077 ▶ Inline flowmeter with oval gears		Type 8201 ▶ Hygienic pH measuring system					
Type 8020 ▶ Insertion flowmeter with paddle wheel							

DTS 1000130448 EN Version: S Status: RL (released | freigegeben | valide) printed: 01.02.2022

10. Ordering information

10.1. Bürkert eShop – Easy ordering and quick delivery



Bürkert eShop – Easy ordering and fast delivery

You want to find your desired Bürkert product or spare part quickly and order directly? Our online shop is available for you 24/7. Sign up and enjoy all the benefits.

[Order online now](#)

10.2. Recommendation regarding product selection

Note:

- The article nos. which are listed in the following tables are equipped of arithmetic, PASS, REJECT, DEVIAT, MATH, PROP, ON/OFF functions as standard (see chapter “[List of available functions](#)” on page 18).
- Only the BASE unit and the device equipped with a main module and a Ethernet module have the flow measurement function as a standard function, the other functions are available as options.
Please also use the Product Enquiry Form at the end of the data sheet for ordering a device with additional options.
- If a totalizer function is required then a flowmeter has to be connected via a digital input (main module or input module).

10.3. Bürkert product filter



Bürkert product filter – Get quickly to the right product

You want to select products comfortably based on your technical requirements? Use the Bürkert product filter and find suitable articles for your application quickly and easily.



























[Try out our product filter](#)

10.4. Ordering chart

Ordering chart for panel-mounted version, 12...36 V DC

Note:

If the device is mounted in a humid environment or outside, then the maximum voltage allowed is 35 V DC instead of 36 V DC.

Description	Inputs				Outputs		Network protocol	UL certification ^{5.)}	Article no.	
	Digital (DI) ^{1.)}	Analogue (AI) ^{2.)}	Number and type of sensor raw signals	Pt100/Pt1000	Transistor (DO) ^{3.)}	Analogue (AO) ^{4.)}				
Base unit (only main module) with flow measurement	2	–	–	–	2	2	–	No	560205 	
								Yes	560213 	
Main module + 1 pH/ORP module	2	–	1 (pH/ORP)	1	2	2	–	No	560200 	
								Yes	560208 	
Main module + 2 pH/ORP modules + 1 output module	2	–	2 (pH/ORP)	2	4	4	–	No	560202 	
								Yes	560210 	
Main module + 1 conductivity module	2	–	1 (cond.)	1	2	2	–	No	560201 	
								Yes	560209 	
Main module + 2 conductivity modules + 1 output module	2	–	2 (cond.)	2	4	4	–	No	560203 	
								Yes	560211 	
Main module + 1 pH/ORP module + 1 conductivity module + 1 output module	2	–	1 (pH/ORP) + 1 (cond.)	2	4	4	–	No	560204 	
								Yes	560212 	
Main module + 1 input module	4	2	–	–	2	2	–	No	563960 	
								Yes	563961 	
Main module + 1 pH/ORP module + 1 input module + 1 output module	4	2	1 (pH/ORP)	1	4	4	–	No	563962 	
								Yes	563963 	
Main module + 1 conductivity module + 1 input module + 1 output module	4	2	1 (cond.)	1	4	4	–	No	563964 	
								Yes	563912 	
Main module with flow measurement + 1 Ethernet module	2	–	–	–	2	2	Modbus TCP ^{6.)}	No	569259 	
								PROFINET ^{7.)}	No	569260 
								EtherNet/IP ^{7.)}	Yes	569261 
Main module + 1 pH/ORP module + 1 Ethernet module	2	–	1 (pH/ORP)	1	2	2	Modbus TCP ^{6.)}	No	569265 	
								PROFINET ^{7.)}	No	569266 
								EtherNet/IP ^{7.)}	Yes	569267 
Main module + 1 conductivity module + 1 Ethernet module	2	–	1 (cond.)	1	2	2	Modbus TCP ^{6.)}	No	569262 	
								PROFINET ^{7.)}	No	569263 
								EtherNet/IP ^{7.)}	Yes	569264 

1.) On/Off or frequency

2.) 0/4...20 mA current and/or 0...2, 0...5, 0...10 V DC voltage

3.) PWM or PFM or On/Off or pulse

4.) 4...20 mA



























5.)  UL-Listed (Measuring Equipment E237737)

6.) If you order a device with a Modbus TCP network protocol, it does not include the other 2. If you would like to change it with a PROFINET or EtherNet/IP network, the Ethernet protocol must be ordered (see chapter "Ordering chart for additional software functions for Type 8619" on page 27).

7.) If you order a device with a PROFINET or EtherNet/IP network protocol, it also contains the other two.

Ordering chart for wall-mounted version, 12...36 V DC
Note:

If the device is mounted in a humid environment or outside, then the maximum voltage allowed is 35 V DC instead of 36 V DC

Description	Inputs				Outputs		Network protocol	UL certification ^{5.)}	Article no.
	Digital (DI) ^{1.)}	Analogue (AI) ^{2.)}	Number and type of sensor raw signals	Pt100/ Pt1000	Transistor (DO) ^{3.)}	Analogue (AO) ^{4.)}			
Base unit (only main module) with flow measurement	2	–	–	–	2	2	–	No	565984 
								Yes	565986 
Main module + 1 pH/ORP module	2	–	1 (pH/ORP)	1	2	2	–	No	565988 
								Yes	565990 
Main module + 2 pH/ORP modules + 1 output module	2	–	2 (pH/ORP)	2	4	4	–	No	565992 
								Yes	565994 
Main module + 1 conductivity module	2	–	1 (cond.)	1	2	2	–	No	565996 
								Yes	565998 
Main module + 2 conductivity modules + 1 output module	2	–	2 (cond.)	2	4	4	–	No	566000 
								Yes	566002 
Main module + 1 pH/ORP module + 1 conductivity module + 1 output module	2	–	1 (pH/ORP) + 1 (cond.)	2	4	4	–	No	566004 
								Yes	566006 
Main module + 1 input module	4	2	–	–	2	2	–	No	566008 
								Yes	566010 
Main module + 1 pH/ORP module + 1 input module + 1 output module	4	2	1 (pH/ORP)	1	4	4	–	No	566012 
								Yes	566014 
Main module + 1 conductivity module + 1 input module + 1 output module	4	2	1 (cond.)	1	4	4	–	No	566016 
								Yes	566018 
Main module with flow measurement + 1 Ethernet module	2	–	–	–	2	2	Modbus TCP ^{6.)}	No	569268 
							PROFINET ^{7.)}	No	569269 
							EtherNet/IP ^{7.)}	Yes	569270 
Main module + 1 pH/ORP module + 1 Ethernet module	2	–	1 (pH/ORP)	1	2	2	Modbus TCP ^{6.)}	No	569274 
							PROFINET ^{7.)}	No	569275 
							EtherNet/IP ^{7.)}	Yes	569276 
Main module + 1 conductivity module + 1 Ethernet module	2	–	1 (cond.)	1	2	2	Modbus TCP ^{6.)}	No	569271 
							PROFINET ^{7.)}	No	569272 
							EtherNet/IP ^{7.)}	Yes	569273 

1.) On/Off or frequency

2.) 0/4...20 mA current and/or 0...2, 0...5, 0...10 V DC voltage

3.) PWM or PFM or On/Off or pulse

4.) 4...20 mA

5.)  UL-Listed (Measuring Equipment E237737)

6.) If you order a device with a Modbus TCP network protocol, it does not include the other 2. If you would like to change it with a PROFINET or EtherNet/IP network, the Ethernet protocol must be ordered (see chapter "Ordering chart for additional software functions for Type 8619" on page 27).

7.) If you order a device with a PROFINET or EtherNet/IP network protocol, it also contains the other two.

Ordering chart for wall-mounted version, 110...240 V AC

Description	Inputs				Outputs		Network protocol	UL certification ^{5.)}	Article no.
	Digital (DI) ^{1.)}	Analogue (AI) ^{2.)}	Number and type of sensor raw signals	Pt100/ Pt1000	Transistor (DO) ^{3.)}	Analogue (AO) ^{4.)}			
Base unit (only main module) with flow measurement	2	-	-	-	2	2	-	No	565985
								Yes	565987
Main module + 1 pH/ORP module	2	-	1 (pH/ORP)	1	2	2	-	No	565989
								Yes	565991
Main module + 2 pH/ORP modules + 1 output module	2	-	2 (pH/ORP)	2	4	4	-	No	565993
								Yes	565995
Main module + 1 conductivity module	2	-	1 (cond.)	1	2	2	-	No	565997
								Yes	565999
Main module + 2 conductivity modules + 1 output module	2	-	2 (cond.)	2	4	4	-	No	566001
								Yes	566003
Main module + 1 pH/ORP module + 1 conductivity module + 1 output module	2	-	1 (pH/ORP) + 1 (cond.)	2	4	4	-	No	566005
								Yes	566007
Main module + 1 input module	4	2	-	-	2	2	-	No	566009
								Yes	566011
Main module + 1 pH/ORP module + 1 input module + 1 output module	4	2	1 (pH/ORP)	1	4	4	-	No	566013
								Yes	566015
Main module + 1 conductivity module + 1 input module + 1 output module	4	2	1 (cond.)	1	4	4	-	No	566017
								Yes	566019
Main module with flow measurement + 1 Ethernet module	2	-	-	-	2	2	Modbus TCP ^{6.)}	No	569277
							PROFINET ^{7.)}	No	569278
							EtherNet/IP ^{7.)}	Yes	569279
Main module + 1 pH/ORP module + 1 Ethernet module	2	-	1 (pH/ORP)	1	2	2	Modbus TCP ^{6.)}	No	569283
							PROFINET ^{7.)}	No	569284
							EtherNet/IP ^{7.)}	Yes	569285
Main module + 1 conductivity module + 1 Ethernet module	2	-	1 (cond.)	1	2	2	Modbus TCP ^{6.)}	No	569280
							PROFINET ^{7.)}	No	569281
							EtherNet/IP ^{7.)}	Yes	569282

1.) On/Off or frequency

2.) 0/4...20 mA current and/or 0...2, 0...5, 0...10 V DC voltage

3.) PWM or PFM or On/Off or pulse

4.) 4...20 mA

5.) UL-Listed (Measuring Equipment E237737)

6.) If you order a device with a Modbus TCP network protocol, it does not include the other 2. If you would like to change it with a PROFINET or EtherNet/IP network, the Ethernet protocol must be ordered (see chapter "Ordering chart for additional software functions for Type 8619" on page 27).







7.) If you order a device with a PROFINET or EtherNet/IP network protocol, it also contains the other two.

DTS 1000130448 EN Version: S Status: RL (released | freigegeben | validé) printed: 01.02.2022

Ordering chart for additional software functions for Type 8619

Note:





- Use the following order codes only in case you already own a 8619 and you like to add one or more functions to your device.
- Please don't forget to note down the article no. and serial number (see the device label) of your multiCELL on your order.
- The function upload and download of the complete data set of the 8619 is available as standard and does not need the data logger option.

Software option	Remark	Article no.
PID control	–	561836 
Data Logger	SD card is not included	561837 
Chemical dosing (e.g. cooling tower)	The “Dosing” option also activates the “Flow” option if it does not exist by default in the device	561838 
Flow measurement	Is already included in the base unit device (article no. 560205 and 560213)	561839 
Concentration measurement of selected fluids	Requires at least one conductivity hardware module	561840 
Protocols Ethernet: Modbus TCP, PROFINET, EtherNet/IP	Ethernet-Module takes 2 slots (available only from Software version B.00.01; already included in the device with a PROFINET or EtherNet/IP network protocol)	569286 
MATH function	–	569848 

10.5. Ordering chart accessories

Note:

You will find more info about sensor-multiCELL connection cable in the data sheet of the selected sensor type. Please consult the corresponding data sheet.

Description	Article no.
SDHC Memory Card - Class 10, 8 GB	564072 
Mounting set for pipe mounting	564596 
 Adapter for cable glands M20 × 1.5 with interface connector RJ45-M12 code D	569242 

Bürkert – Close to You

For up-to-date addresses
please visit us at
www.burkert.com

DTS 1000130448 EN Version: S Status: RL (released | freigegeben | validé) printed: 01.02.2022



Product Enquiry Form - multiCELL Transmitter/Controller

Thank you for your interest in our products! In order to provide you with optimum advice, please fill out the following form and send it to your **Bürkert representative** or e-mail address: info@burkert.com. All information submitted will of course be kept strictly confidential.

Note: The interactive functions of this PDF may be restricted depending on the PDF reader used.

Personal Information			
Company		Contact person	
Customer no.		Department	
Street		Country / Postcode / Town	
Telephone no.		Email	

Delivery	
Quantity	Required delivery date

Note:

If a totalizer function is required then a flowmeter has to be connected via a digital input (Main module or input module).

Models
Panel-mounted version, 12...36 V DC, called multiCELL
Wall-mounted version, 12...36 V DC, called multiCELL WM DC
Wall-mounted version, 110...240 V AC, called multiCELL WM AC

Hardware						
Main module ^{1.)} (without flow function; if needed please order the flow measurement software option)						
Slot	M1	M2	M3	M4	M5	M6
Ethernet module (takes up M1 and M3 slots)	Delete Ethernet module selection					
Conductivity + temperature module						
pH/ORP + temperature module						
Output module ^{2.)}						
Input module ^{3.)}						

1.) 2 digital inputs + 2 analogue outputs + 2 transistor outputs

2.) 2 analogue outputs + 2 transistor outputs

3.) 2 analogue inputs + 2 digital inputs

Software		
PID	Yes	No
Data logger	Yes	No
Chemical dosing ^{1.)} (e.g. Cooling Tower) + special batch	Yes	No
Flow measurement	Yes	No
Concentration Measurement for selected fluids (only if one of the slot is equipped with a conductivity module)	Yes	No
MATH function	Yes	No

1.) The "Dosing" option also activates the "Flow" option if it does not exist by default in the device.

Ethernet protocols		
Modbus TCP	PROFINET	EtherNet/IP

Certification		
UL listed 1 + CULus	Yes	No